

# NORCOLD®



## **Service Manual**

**For model N300 - a 2.7 cu. ft., 2-way refrigerator.**

**For model N300.3 - a 2.7 cu. ft., 3-way refrigerator.**

## Table of Contents

---

Introduction .....	2
Safety Awareness .....	2
Safety Instructions .....	2
Specifications .....	3
Operating limits .....	3
Ratings .....	3
Current draws .....	3
Replacement fuses (refrigerator control panel) .....	3
Ventilation Requirements .....	4
Propane Gas Components .....	4
Examine the gas supply system for leaks .....	4
Electrical Components .....	5
Examine the 120 volts AC supply .....	5
Examine the 12 volts DC supply (3-way models) .....	5
Controls .....	5
Ignition and Start Up .....	6
Ignition - propane gas operation .....	6
Start up - AC electric operation .....	6
Start up - DC electric operation (3-way models) .....	6
Shut down .....	6
Battery drain .....	6
Refrigerator Maintenance .....	6
Gas flame appearance .....	6
Remove and clean the burner orifice .....	6
Diagnosing Cooling Problems .....	6
Wiring Pictorial .....	7
Wiring Diagram .....	7
Troubleshooting Charts .....	8
Refrigerator will not operate on AC .....	8
Refrigerator will not operate on DC (3-way models) .....	9
Burner ignites but does not maintain flame .....	10
Part Replacement .....	11
Selector switch .....	11
Thermostat .....	11
AC heater .....	11
DC heater (3-way models) .....	11
Thermocouple .....	12
Thermocouple interrupter .....	12
Gas safety valve .....	12

## Introduction

---

This Service Manual supplies information for the experienced repair technician. The repair technician should have working knowledge of the operation of an absorption refrigerator system and should have basic knowledge of LP gas and electrical systems.

Read and understand the "Installation and Owner's Manual", all service procedures, cautions and warnings before doing any service work on the refrigerator. If you are unable to resolve the problem by using this Service Manual, technical service support is available at 1-800-444-7210.

Only use genuine Norcold replacement parts on the refrigerator. Generic parts do not meet Norcold's specifications for reliability, performance, and safety and will void the Norcold Limited Warranty.

## Safety Awareness

---

Read this manual carefully and understand the contents before you install and operate the refrigerator.

Be aware of possible safety hazards when you see the safety alert symbol on the refrigerator and in this manual. A signal word follows the safety alert symbol and identifies the danger of the hazard. Carefully read the descriptions of these signal words to fully know their meanings. They are for your safety.



**WARNING:** This signal word identifies a hazard, which if ignored, can cause dangerous personal injury, death, or much property damage.



**CAUTION:** This signal word identifies a hazard, which if ignored, can cause small personal injury or much property damage.

## Safety Instructions

---



**WARNING:**

- This refrigerator is equipped for the use of propane gas only and can not be changed to use any other fuels (natural gas, butane, etc.).
- Incorrect installation, adjustment, changes to, or maintenance of this refrigerator can cause personal injury, property damage, or both.
- Obey the instructions in this manual to install the intake and exhaust vents.
- Do not install the refrigerator directly on carpet. Put the refrigerator on a metal or wood panel that extends the full width and depth of the refrigerator.
- Propane gas can cause a fire or an explosion that can result in property damage, personal injury, or death. Do not smoke or create sparks while doing any work on the propane gas supply system. Do not use an open flame to examine the gas supply piping or fittings for leaks.
- To avoid possible propane gas leaks, always use two wrenches to tighten or loosen the gas supply line connections.
- Make sure the electrical installation obeys all applicable codes. See the "Certification and Code Requirements" section of the "Owner's Manual and Installation Manual".
- Disconnect both the AC and DC power sources before doing any maintenance work on the refrigerator.
- Do not bypass or change the refrigerator's electrical components or features.

- Do not spray liquids near electrical outlets, connections, or the refrigerator components. Many liquids are electrically conductive and can cause a shock hazard, electrical shorts, and in some cases fire.
- The refrigerator cooling system is under pressure. Do not try to repair or to recharge a defective cooling system. The cooling system contains sodium chromate. The breathing of certain chromium compounds can cause cancer. The cooling system contents can cause severe skin and eye burns, and can ignite and burn with an intense flame. Do not bend, drop, weld, move, drill, puncture, or hit the cooling system.
- The storage of flammable materials behind or around the refrigerator creates a fire hazard. Do not use the area behind the refrigerator to store flammable materials (gasoline, cleaning supplies, etc.)
- Do not remove the round ground prong from the refrigerator AC power cord. Do not use a two prong adapter or extension cord on the AC power cord.
- A circuit overload can result in an electrical fire if the wires and/or fuse sizes are not correct. Use only the wire and fuse sizes written in the "Owner's Manual and Installation Manual"
- To prevent child entrapment, make sure all shelf retainers are correctly fastened and remove the doors before disposing of the refrigerator.



**CAUTION:**

- The rear of the refrigerator has sharp edges and corners. To prevent cuts or abrasions when working on the refrigerator, be careful and wear cut resistant gloves.
- Make sure all fasteners and connections are tight.

## Specifications

---

### Operating limits:

AC Operation:	108 VAC Min. - 132 VAC Max.
DC Operation: (3-way models)	13.5 VDC Min. - 15.4 VDC Max.
Propane Gas Operation	10.5 Inch Water Column Min. - 11.5 Inch Water Column Max.

### Ratings:

AC Operation:	110 Volts AC, 180 Watts
DC Operation: (3-way models)	14 Volts DC, 150 Watts
Propane Gas Operation:	640 BTU per Hr Input 11 Inch W.C. Gas Supply No. 10 Orifice (LP10)

### Current draws:

AC Heater:	1.6 Amps @ 110 VAC 1.5 Amps @ 120 VAC
Resistance	67.2 Ohms
DC Heater Resistance	10.7 Amps @ 14 VDC 1.3 Ohms

### Replacement fuses:

AC Circuit	3 Amp Type 3AG (1 1/4" x 1/4") Norcold P/N: 61654622
DC Circuit:	20 Amp Type 3AG (1 1/4" x 1/4") Norcold P/N: 61440522

## Ventilation Requirements

---



**WARNING:** The completed installation must:

- Make sure there is sufficient intake of fresh air for combustion.
- Make sure the living space is completely isolated from the combustion system of the refrigerator.
- Make sure there is complete and unrestricted ventilation of the flue exhaust which, in gas mode, can produce carbon monoxide. The breathing of carbon monoxide fumes can cause dizziness, nausea, or in extreme cases, death.

Certified installation needs one lower intake vent and one upper exhaust vent. Install the vents through the side wall of the vehicle exactly as instructed in this manual. Any other installation method voids both the certification and the factory warranty of the refrigerator.

The bottom of the opening for the lower intake vent, which is also the service access door, must be even with or immediately below the floor level. This allows any leaking LP gas to escape to the outside and not to collect at floor level.

American Gas Association/Canadian Gas Association (AGA/CGA) certification allows the refrigerator to have zero (0) inch minimum clearance at the sides, rear, top, and bottom. While there are no maximum clearances specified for certification, the following maximum clearances are necessary for correct refrigeration:

Bottom	0 inch min.	0 inch max.
Each Side	0 inch min	1/8 inch max.
Top	0 inch min.	1/4 inch max.
Rear	0 inch min.	1 inch max.

These clearances plus the lower and upper vents cause the natural air draft that is necessary for good refrigeration. Cooler air goes in through the lower intake vent, goes around the refrigerator coils where it removes the excess heat from the refrigerator components, and goes out through the upper exhaust vent. If this air flow is blocked or decreased, the refrigerator may not cool correctly.

Each NORCOLD model is certified by AGA and CGA for correct ventilation.

## Propane Gas Components

---

This refrigerator operates on propane gas at a pressure of 10.5 inches Water Column min. to 11.5 inches Water Column max.



**WARNING:** Be very careful when working on or near the propane gas system.

- Do not smoke, or use an open flame near the propane gas system.
- Do not use an open flame to examine for leaks.
- Do not connect the refrigerator to the propane gas tank without a pressure regulator between them.
- To avoid possible propane gas leaks, always use two wrenches to tighten or loosen the gas supply line connections.
- Leaking propane gas can ignite or explode and result in dangerous personal injury or death.

### Examine the gas supply system for leaks:



**WARNING:** Do not allow the leak detecting solution to touch the electrical components. Many liquids are electrically conductive and can cause a shock hazard, electrical shorts, and in some cases fire.

Using a solution of liquid detergent and water, make sure the gas supply line and all gas connections have no leaks. Do not use any liquid that contains ammonia.

If you use compressed air for the test:

- The pressure of the compressed air at the manual shutoff valve of the refrigerator must not be more than 1/2 psig (14 inches Water Column).
- If the pressure of the compressed air is more than 1/2 psig (14 inches Water Column), remove the gas supply line from the manual shutoff valve of the refrigerator before the test.
- If the pressure of the compressed air is equal to or less than 1/2 psig (14 inches Water Column), close the manual shutoff valve of the refrigerator before the test.

## Electrical Components

---

This refrigerator operates on these electrical sources.

AC Operation	120 volts AC voltage (108 volts min. - 132 volts max.)
DC Operation (3-way models)	14 volts DC voltage (13.5 volts min. - 15.4 volts max.)

Operation out of these limits may damage the refrigerator's electrical circuit parts and will void the warranty.

### Examine the 120 volts AC supply:



**WARNING:** Connect the AC power cord only to a grounded three-prong receptacle. Do not remove the round ground prong from the power cord. Do not use a two-prong adapter or an extension cord. Operation of the refrigerator without a correct ground could cause dangerous electrical shock or death if you are touching the metal parts of the refrigerator or the vehicle.

- Make sure the AC power cord is in a grounded three-prong receptacle.
- Make sure the receptacle is within easy reach of the lower intake vent.
- Make sure the power cord does not touch the burner cover, the flue pipe, or any hot component that could damage the insulation of the power cord.

### Examine the 12 volt DC supply (3-way models):

The refrigerator gets power from the 12 volt system of the vehicle; either from the battery or from an auxiliary (house) battery. The battery system not only supplies DC power to the refrigerator, but also to other components of the vehicle.

The DC heating element, which supplies power for cooling during DC operation, has a high current draw and can cause rapid battery drain.

Make sure the 12 volt DC supply is connected correctly:

- Make sure the DC negative wire from the battery is connected to the black DC wire on the terminal block of the refrigerator.
- Make sure the DC positive wire from the battery is connected to the red DC wire on the terminal block of the refrigerator.
- Make sure an in-line fuse is installed on the DC positive wire, as near the battery as possible, between the battery and the terminal block of the refrigerator.

**NOTE:** This in-line fuse is necessary for added safety, even though the refrigerator has a DC fuse in the control assembly.

## Controls





---

The thermostat [1] changes the amount of propane gas that goes to the burner (See Art00976). This acts as the temperature control of the refrigerator. Number 5 is the coldest temperature setting.

**NOTE: The thermostat is not an automatic gas control. It does not automatically change the flame from high fire to low fire as do other RV refrigerators. If the cooling load changes, you must manually change the gas control to maintain the same temperature inside the refrigerator.**

When the outside air temperature is less than 50° F, the refrigerator may have a tendency to freeze food at the colder temperature settings. To reduce the tendency to freeze food:

- Turn the thermostat to a warmer temperature setting.
- Keep the refrigerator full.
- Put foods that are more likely to freeze on the upper shelf.

The selector switch [2] changes the energy source of the refrigerator between propane gas (  ), AC electric (  ), and DC electric (  ) and shuts down the refrigerator at the OFF (  ) position.

The gas safety valve [3] is built into the control panel. As long as a flame is present, the valve is open and allows propane gas to flow into the burner. Any loss of flame (empty propane gas tank, blow out, etc.) closes the valve and stops the flow of propane gas.

The igniter [4] makes a spark which ignites the flame in the burner.

The flame meter [5] shows if a flame is present in the burner.

## Ignition and Start Up

---

Before ignition or start up of the refrigerator:

- Make sure the air flow in the lower intake vent, through the refrigerator coils and condenser, and out the upper exhaust vent is not blocked or decreased.
- Make sure there are no combustible materials in or around the refrigerator.

### Ignition - propane gas operation:

1. Open the valve at the propane gas storage tank.
2. Open the manual shut off valve of the refrigerator.
3. Turn the thermostat [1] to the 5 position (See Art00976).
4. Turn the selector switch [2] to the gas position (  ).
5. Push and hold in the safety valve [3] and in rapid succession push in the igniter several times for about five seconds:



**WARNING:** Do not hold the safety valve in more than 30 seconds. If there is no flame in this time, wait at least five minutes before you try ignition again. If you continue to hold in the safety valve, gas will collect in the burner area. This could cause a fire or explosion and result in dangerous personal injury or death.

- When a flame is present, and the flame meter [5] moves into the green area, release the safety valve.
  - If the flame meter does not move into the green area or does not remain in the green area, wait about five minutes and do this step again.
6. Turn the thermostat to the temperature setting that you wish.

### Start up - AC electric operation:

- Make sure that 120 volts AC is available.
- Turn the selector switch to the AC position (  ).
- Turn the thermostat to the temperature setting that you wish.

### Start up - DC electric operation (3-way models):

- Make sure that 12 volts DC is available.
- Turn the selector switch to the DC position (  ).

### Shut down:

- Turn the selector switch to the OFF position (  ).
- Turn the thermostat to the 1 position.

### Battery drain:

- In AC operation, there is no battery drain.
- In DC operation, the refrigerator draws 11 amps at 14 volts.
- If the battery charging stops during DC operation, change the refrigerator to gas or AC operation until the battery charging starts again.
- Check the voltage when in DC operation. The voltage should never drop below 13.5 volts.

## Refrigerator Maintenance

---

### Gas flame appearance:

While in LP gas operation, examine the appearance of the gas flame:

- Turn the thermostat to the 5 position.
- Open the lower intake vent.



**CAUTION:** The burner box cover can be hot. Wear gloves to avoid burns.

- Open the burner box door [3] and look at the gas flame [1] (See Art00955 and Art00982).
  - The flame should be a darker blue inside and a lighter blue outside and should be a constant and steady shape.
  - The flame should not be yellow and should not have an erratic and unstable shape.
  - Make sure the flame does not touch the inside of the flue tube [2].
- Close the burner box door.

### Remove and clean the burner orifice:

To remove and clean the burner orifice:

- Close the valve at the propane gas tank(s).
- Open the lower intake vent.
- Close the manual shut off valve of the refrigerator.
- Turn the gas control to the OFF position (  ).
- Remove the burner box cover by removing one screw.



**WARNING:** To avoid possible propane gas leaks, always use two wrenches to loosen and tighten the gas supply line at the refrigerator's manual shut off valve.

- Remove the flare nut from the orifice assembly [1] (See Art00956).
- Remove the orifice assembly from the burner [2]



**WARNING:** When cleaning, do not try to remove the orifice [3] from the orifice adapter [4]. Removal will damage the orifice and can cause a propane gas leak. Leaking propane gas can ignite or explode and result in dangerous personal injury or death. Do not clean the orifice with a pin or other objects.

- Clean the orifice assembly with air pressure and alcohol only.
- Using a wrench, assemble the orifice assembly to the burner.
- Assemble the flare nut to the orifice assembly.
- Examine all of the gas connections for leaks.

## Diagnosing Cooling Problems



**WARNING:** The refrigerator cooling system is under pressure. Do not try to repair or to recharge a defective cooling system. The cooling system contains sodium chromate. The breathing of certain chromium compounds can cause cancer. The cooling system contents can cause severe skin and eye burns, and can ignite and burn with an intense flame. Do not bend, drop, weld, move, drill, puncture, or hit the cooling system.

Make sure the cooling unit has the correct ventilation:

- Make sure that the intake and exhaust vents are not blocked.
- Make sure that the air flow through the back of the refrigerator is not decreased or blocked.
- Make sure the ventilation baffle is correctly installed.

Examine the cooling unit for leaks.



**WARNING:** If you think that the cooling system has a leak, do not operate the refrigerator. Replace the cooling unit before operating the refrigerator.

- If you smell ammonia, the cooling unit has a leak and must be replaced.
- If you see a yellow powder or residue anywhere at the rear of the refrigerator or in the enclosure, the cooling unit has a leak and must be replaced.

Determine if the cooling problem occurs while operating the refrigerator on propane gas, AC electric, and DC electric:

- Determine if the selected energy source is operating and heating correctly:



**CAUTION:** Touch only the outside of the insulation sleeve. During normal operation, some tubes of the cooling unit are hot. Do not touch any tubes of the cooling unit.

- Within 20 minutes of starting the refrigerator, touch the outside of the insulation sleeve.

- The outside of the insulation sleeve should be warm to the touch.
- If the outside of the insulation sleeve is not warm, the selected energy source may not be operating correctly.
- Start up the refrigerator on a different energy source and repeat the procedure for all energy sources.
- If the outside of the insulation sleeve is warm to the touch, make sure the unit is cooling correctly.
  - Within one hour after starting up the refrigerator, touch the fins on the inside of the fresh food compartment.
  - The fins should feel cold to the touch.
  - If the fins do not feel cold to the touch after two hours, the cooling unit is not operating correctly.
- If the cooling problem does not occur when operating on all energy sources, the problem is not the cooling unit.
  - Use the "Troubleshooting Charts" to determine the cause of the problem.

## Wiring Pictorial

The parts of the wiring pictorial are (See Art01020):

1. .... 120 VAC Power cord
2. .... Terminal block
3. .... 3 Amp fuse
4. .... Selector switch
5. .... Thermocouple
6. .... Thermostat / gas safety valve
7. .... Thermocouple interrupter
8. .... Flame meter
9. .... AC heater
10. .... -12 VDC Power supply (3-way models)
11. .... +12 VDC Power supply (3-way models)
12. .... 20 Amp fuse (3-way models)
16. .... DC heater (3-way models)

## Wiring Diagram

The parts of the wiring diagram are (See Art01021):

1. .... 120 VAC
2. .... 3 Amp fuse
3. .... Thermostat
4. .... AC heater
5. .... 120 VAC
6. .... Gas safety valve
7. .... Thermocouple interrupter
8. .... Flame meter
9. .... Piezo lighter
10. .... Spark gap
11. .... Thermocouple
12. .... +12 VDC (3-way models)
13. .... 20 Amp fuse (3-way models)
14. .... DC heater (3-way models)
15. .... -12 VDC Com(3-way models)
17. .... Selector switch

**Refrigerator will not operate on AC.**

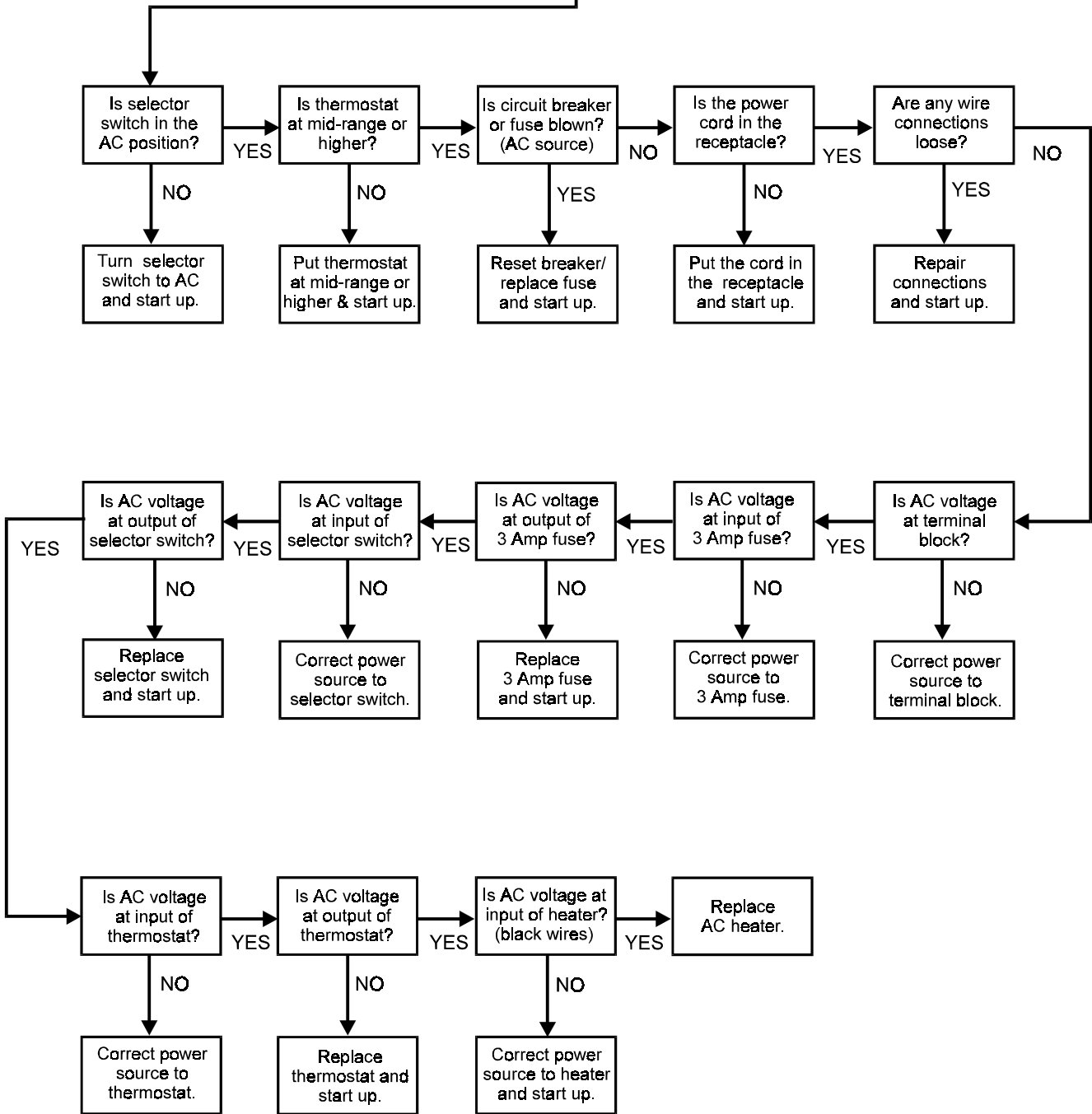

Art00997



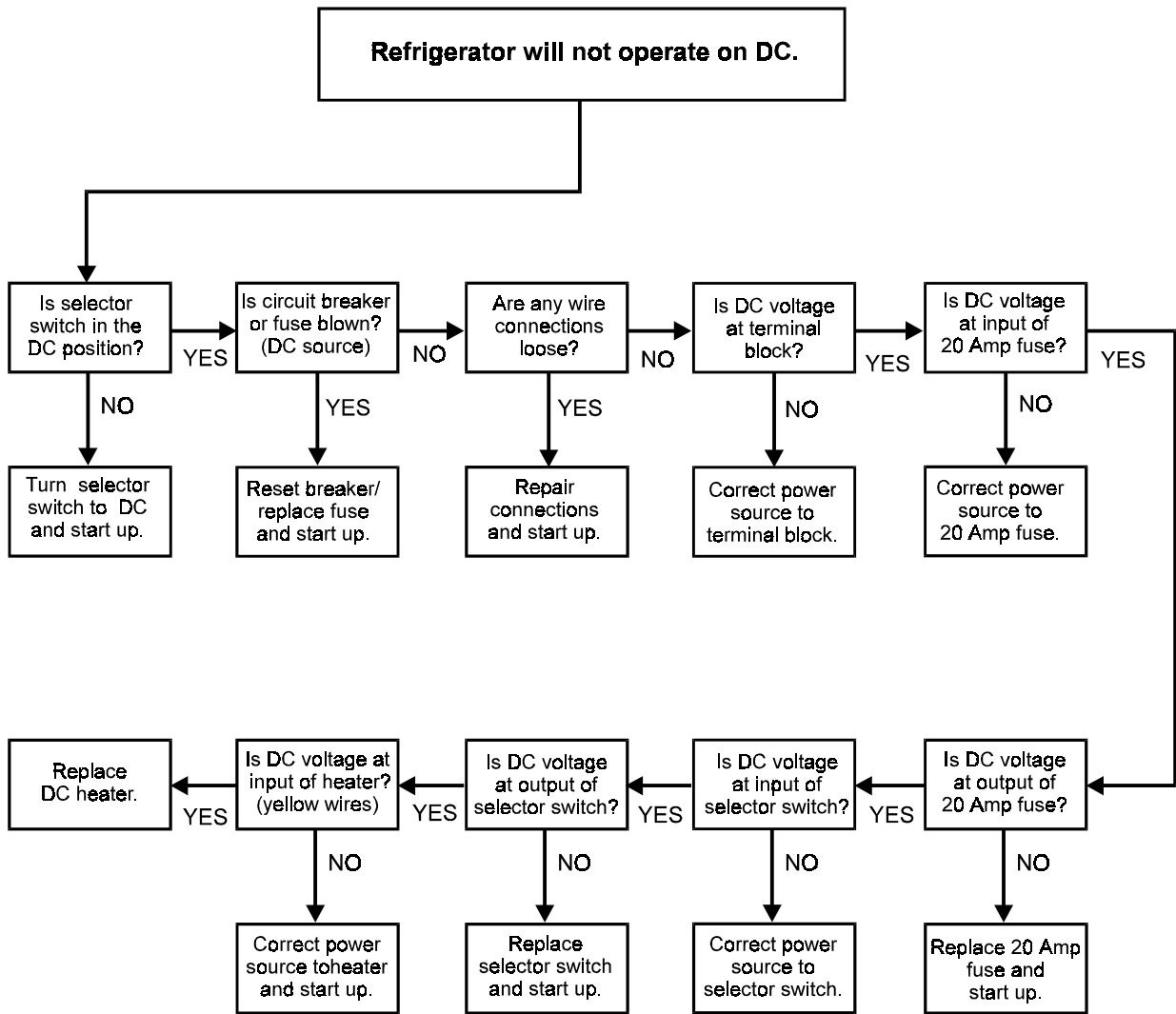

Art00998

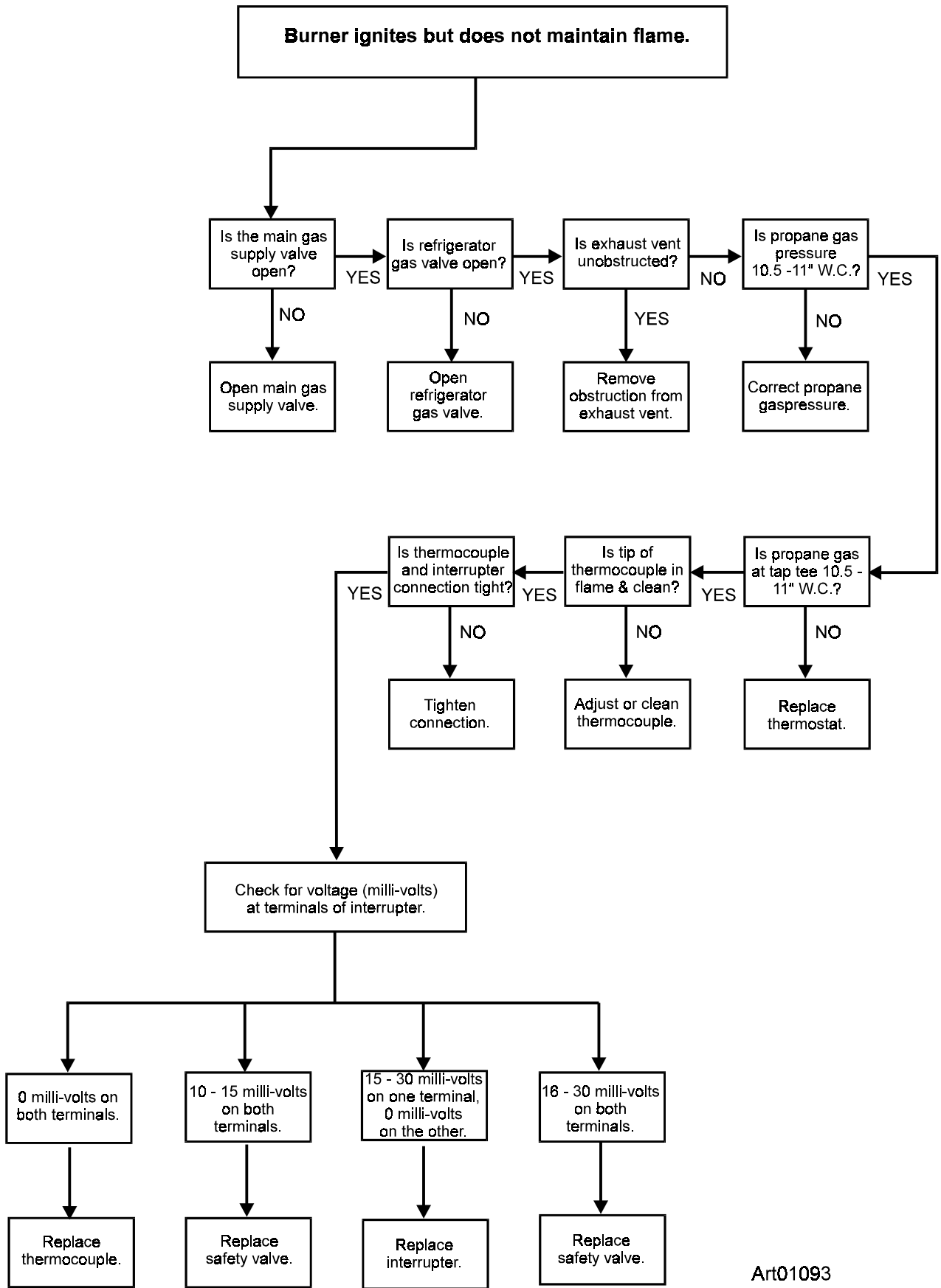

Art01093

## Part Replacement

---

If the "Troubleshooting Charts" tell you to replace a part, use the following instructions.

### Selector switch

1. Close the valve of the propane gas tank(s).
2. Pull the knob off the selector switch.
3. Remove the two screws that attach the selector switch.
4. Gently pull the selector switch away from the back of the control panel.
5. Remove each wire, one at a time, from the selector switch and install in exactly the same location on the replacement selector switch. (See Art01020 and Art01021)
6. To install the replacement selector switch, do steps 1-4 in reverse.

### Thermostat

1. Close the valve of the propane gas tank(s).
2. Pull the knob off the thermostat.
3. Remove the gas supply line from the inlet flare fitting of the thermostat.
4. Remove the safety valve from the thermostat. (See page 12)
5. Remove the two screws that attach the thermostat to the bracket.
6. Remove the two red wires from the thermostat.
7. Remove the clips that attach the capillary tube to the cooling fin inside the refrigerator.

NOTE: The capillary tube is located on the fifth cooling fin from the right.

8. Gently pull the capillary tube through the back of the refrigerator cabinet.
9. To install the replacement thermostat, do steps 1-8 in reverse.
  - Make sure the capillary tube is flat against the cooling fin
10. Examine all the gas connections for leaks.

### AC heater

1. Remove the AC power cord from the receptacle.
2. To make sure the other energy sources do not activate, turn the selector switch to the OFF ( ● ) position.
3. Remove the two blue wires that connect the AC heater to the terminal block.
4. Using a utility knife, vertically cut through the insulation that surrounds the flue tube.

5. Remove the insulation.
6. Pull the AC heater up and out of the heater well.
7. Push the replacement AC heater down into the heater well.
  - Make sure the bead of weld on the AC heater touches the top of the heater well.
8. Put the insulation around the flue tube.
  - Make sure the insulation is completely around the flue tube.
9. Tape the insulation closed.
10. Attach the two blue wires of the AC heater to the terminal block.
11. Put the AC power cord in the receptacle.

### DC heater (3-way models)

1. Remove the DC input leads from the refrigerator.
  - Put tape on the positive lead to prevent an accidental electrical short and a blown fuse.
2. To make sure the other energy sources do not activate, turn the selector switch to the OFF ( ● ) position.
3. Remove the two yellow wires that connect the DC heater to the terminal block.
4. Using a utility knife, vertically cut through the insulation that surrounds the flue tube.
5. Remove the insulation.
6. Pull the DC heater up and out of the heater well.
7. Push the replacement DC heater down into the heater well.
  - Make sure the bead of weld on the DC heater touches the top of the heater well.
8. Put the insulation around the flue tube.
  - Make sure the insulation is completely around the flue tube.
9. Tape the insulation closed.
10. Attach the two yellow wires of the DC heater to the terminal block.
11. Make sure that a 20 Amp fuse is in the fuse holder.
12. Attach the DC input leads from the refrigerator.

## Thermocouple

1. Close the valve at the main propane gas tank(s).
2. Remove the thermocouple from the thermocouple interrupter.
3. Remove the burner box cover.
4. Remove the two screws that attach the thermocouple bracket to the burner box.
5. Remove the thermocouple from the thermocouple bracket.
6. Remove the wires from the thermocouple interrupter.
7. Using two wrenches, loosen the thermocouple interrupter from the safety valve.
8. Turn the thermocouple interrupter about half way out of the safety valve.
9. Turn the thermocouple only about half way into the thermocouple interrupter.
10. Using two wrenches, fully tighten the thermocouple interrupter onto the safety valve.
11. Fully tighten the thermocouple onto the thermocouple interrupter.
12. Attach the wires to the thermocouple interrupter.
13. Do steps 1-5 in reverse.
14. Examine all the gas connections for leaks.

## Thermocouple interrupter

1. Close the valve at the main propane gas tank(s).
2. Remove the thermocouple from the thermocouple interrupter.
3. Remove the wires from the thermocouple interrupter.
4. Using two wrenches, remove the thermocouple interrupter from the safety valve.
5. Turn the replacement thermocouple interrupter only about half way into the safety valve.
6. Turn the thermocouple only about half way into the replacement thermocouple interrupter.
7. Using two wrenches, fully tighten the thermocouple interrupter onto the safety valve.
8. Fully tighten the thermocouple onto the thermocouple interrupter.
9. Attach the wires to the thermocouple interrupter.
10. Open the valve at the main propane gas tank(s).
11. Examine all the gas connections for leaks.

## Safety valve

1. Close the valve at the main propane gas tank(s).
  2. Remove the thermocouple from the thermocouple interrupter.
  3. Remove the wires from the thermocouple interrupter.
  4. Using two wrenches, remove the thermocouple interrupter from the safety valve.
  5. Remove the gas outlet fitting from the safety valve.
  6. Remove the safety valve from the thermostat.
  7. Assemble the replacement safety valve to the thermostat.
- NOTE: Put "Loctite" or similar product on the threads of the gas outlet fitting to make sure the connection does not leak.
8. Assemble the replacement safety valve to the gas outlet fitting.
  9. Turn the thermocouple interrupter only about half way into the replacement safety valve.
  10. Turn the thermocouple only about half way into the thermocouple interrupter.
  11. Using two wrenches, fully tighten the thermocouple interrupter onto the safety valve.
  12. Fully tighten the thermocouple onto the thermocouple interrupter.
  13. Attach the wires to the thermocouple interrupter.
  14. Examine all the gas connections for leaks.

## Refrigerator

1. Close the valve at the main propane gas tank(s).
2. Remove the gas supply line from the bulkhead fitting of the refrigerator.
3. Remove the AC power cord from the receptacle.
4. Remove the DC input leads from the refrigerator.
  - Put tape on the positive lead to prevent an accidental electrical short and a blown fuse.
5. Remove the screws that attach the refrigerator to the floor.
6. Remove the screws that attach the refrigerator to the wall.
7. Remove the refrigerator from the opening.
8. To install the refrigerator, do steps 1-7 in reverse.
9. Examine all the gas connections for leaks.

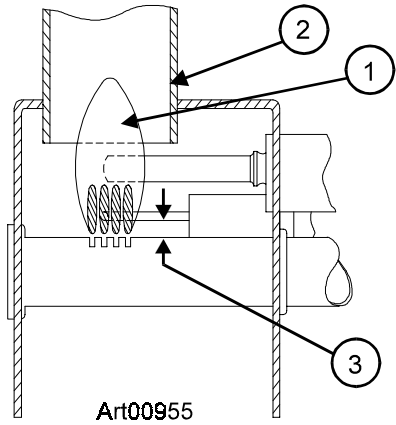

Art00955

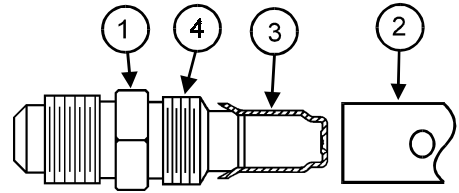

Art 00956

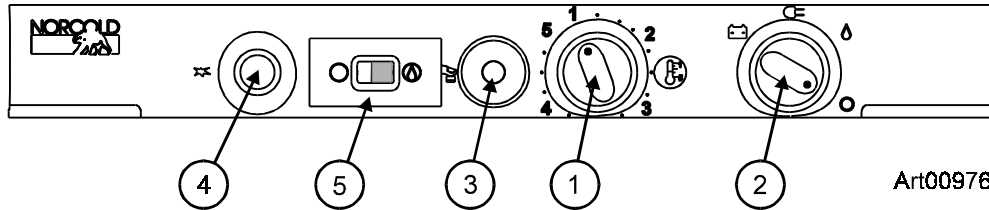

Art00976

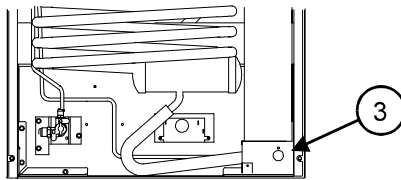

Art00982

