

Electrolux

UPRIGHT FREEZER TF422

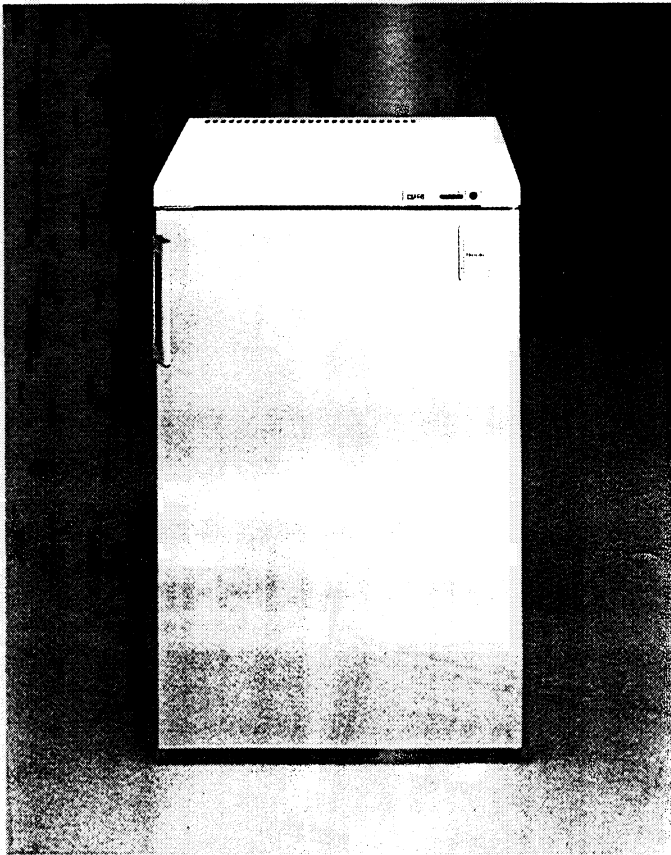

User's Handbook

Your new Electrolux freezer will store frozen food and freeze fresh food and is an ideal companion for a matching Electrolux RF593 larder refrigerator.

For best results, it's important that you read all the contents of this handbook before you use your freezer.

At first you may be aware of sounds in your kitchen which you are not used to, particularly if your freezer is against sound-reflective surfaces such as tiled or painted walls. Please remember the cooling unit includes precision-built components which, like those in car engines and other machinery with fast moving parts, need a running-in period which may last for several weeks. During this period, don't worry, — just allow the appliance time to settle down.

Before using your freezer, we advise you to wash the inside and fittings as described on page 14 under 'cleaning'.

- ① Freezing/storage compartment
- ② Pull-out storage basket
- ③ Storage compartment (lift flap to open)
- ④ Indicator lights
- ⑤ Thermostat dial
- ⑥ Level adjusters
- ⑦ Ice scraper
- ⑧ Ice store

SAFETY NOTE

If this appliance is replacing an old one which is going to be scrapped, remove the door before disposal to prevent children from becoming trapped inside.

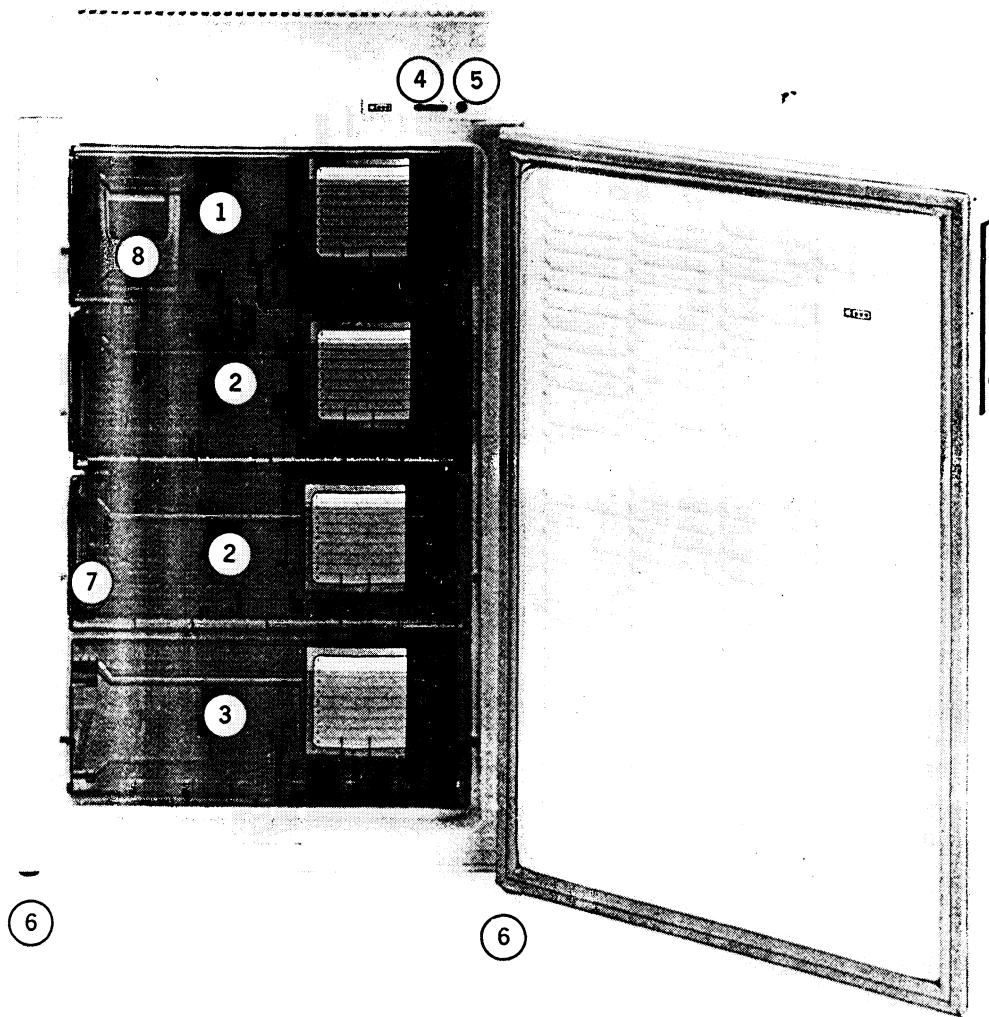

About your freezer

Door hang

The chosen position may make it preferable to change over the hinges and door handle to reverse the door hang. To do this, refer to 'Changing over the door hinges' on page 14.

Where to install

For the cooling unit to work efficiently, your freezer should be located in a dry atmosphere, out of direct sunlight and away from extreme temperatures, e.g. not next to a cooker or other sources of direct heat, or in a very cold room such as an outhouse, where the temperature may fall below 6°C (43°F).

Leave a clearance of at least 50mm (2ins) above the freezer and don't obstruct the space underneath. The back may be placed close to the wall but should not touch it. Do not install in a small pantry or in other places with restricted ventilation.

If your freezer is to be placed under a worktop, please refer to the instructions given on page 15.

Your freezer must be stood on a strong firm floor and should be level. Adjustable feet are provided at the front corners of the cabinet for adjusting the level — see illustration.

Make sure the freezer is standing upright and the adjusters are in firm contact with the floor so that the cabinet does not rock in any direction.

Connecting to the mains

Before you use your freezer, check that the voltage shown on the data label inside the cabinet conforms with your mains supply.

The mains lead of the freezer is fitted with a non-rewireable moulded-on 13 amp plug containing a 13 amp fuse. If the fuse requires replacing at any time, the fuse cover/carrier should be removed, using a small screwdriver to lever it out. The old fuse should be replaced by a 13 amp ASTA approved BS1362 fuse and the fuse cover/carrier *must* be refitted before the plug is used again.

If the fuse cover/carrier is lost, a replacement can be obtained from the Electrolux Service Shops and offices listed on page 18. The fuse cover/carrier must be of the same colour as that of the coloured insert in the base of the plug. **In no circumstances must the plug be used without a correct fuse cover/carrier fitted.**

If the plug supplied on the freezer mains lead is not suitable for the socket outlet in your home, it should be cut off and disposed of safely, or destroyed, to avoid any possible shock hazard resulting from the plug being inserted into a 13 amp socket elsewhere in the house. A suitable replacement plug should then be fitted as given below. (If a 13 amp plug and socket are not used, the circuit supplying the freezer should contain a 10 amp fuse).

**WARNING —
THIS APPLIANCE MUST BE EARTHED.**

IMPORTANT

The wires in the mains lead of this appliance are coloured in accordance with the following code:-

GREEN-and-YELLOW	: EARTH
BLUE	: NEUTRAL
BROWN	: LIVE

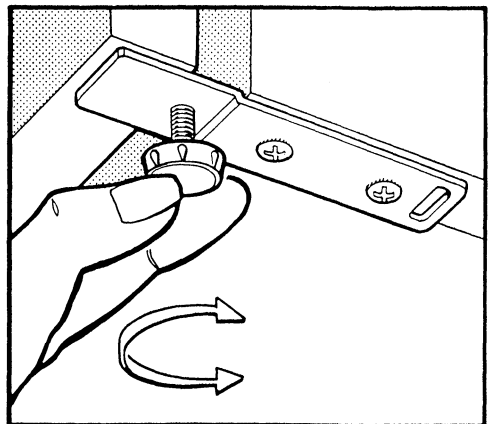

Setting the controls

As the colours of the wires in the mains lead may not correspond with the coloured markings identifying the terminals in your plug, proceed as follows:-

Connect the GREEN-and-YELLOW coloured wire to the plug terminal marked letter E or earth symbol  or coloured green or green-and-yellow.

Connect the BLUE coloured wire to the plug terminal marked letter N or coloured black.

Connect the BROWN coloured wire to the plug terminal marked letter L or coloured red.

If at any time a replacement mains lead is required, the cross sectional area of its conductors must not be less than 0.75mm².

The cover of the terminal box can be removed to gain access to the mains lead terminals after releasing the two clips with a small screwdriver, *but remember to first disconnect the plug from the electricity supply socket.*

However, we recommend that this operation be carried out by a member of the Electrolux Service organisation or a qualified electrician.

The controls for operating the freezer are located at the top front — see illustration below.

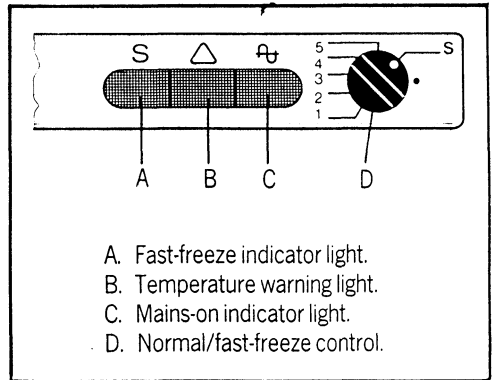

To start cooling, plug into the wall socket and switch on. Insert a small coin in the groove located in the thermostat dial, and turn the dial in a clockwise direction to about midway position. The 'mains on' light  will come on.

The temperature required in the freezer is -18°C (0°F) or below and under normal conditions, this temperature will be obtained at the suggested setting.

However, the temperature inside the freezer will be affected by location, room temperature or frequency of door opening and adjustment of the thermostat setting may be necessary to allow for this.

If lower temperatures are required (eg during hot weather), turn the thermostat dial clockwise to a *higher* number or, for less cooling, anti-clockwise to a *lower* number.

We advise you to run your freezer for a day before storing frozen food.

Using the freezer

Fast-freeze setting and yellow indicator light 'S'

The fast-freeze setting overrides the thermostat and should be used when freezing fresh foods as explained later. When the fast-freeze setting is in use (i.e. with the thermostat dial set against 'S') the light will come on as a reminder.

Temperature warning light

The light in the control panel will come on as a warning if the temperature in the freezer rises above the level required for the safe storage of frozen food, — provided of course that electricity is still available and that the thermostat is at the correct setting.

The light will come on when first starting up the freezer and possibly after opening the door, or while freezing fresh food, but it should go out as soon as the temperature falls to the correct level. If it does not, it indicates that something is wrong.

The  symbol means that your freezer will store food at -18°C (0°F) for long term storage and will also freeze fresh food.

Storing frozen food

Your freezer has the following capacities:

Nett Storage Volume		*Weight of Stored Food	
litres	cubic ft	kg	lb
110	3.9	35.2	77.6

**This is a standard measurement and the actual capacity depends upon the density and sizes of food. The above figures are based on an average density of 0.32 kg per litre.*

Pre-packed commercially frozen food should be stored in accordance with the manufacturer's instructions for 3 star frozen food compartments and should be put into the freezer as soon as possible after purchase. Your freezer provides for long term storage which generally means up to 3 months but the length of storage time can vary and it is important to follow the recommended times shown on packets of commercially frozen food.

Storage times for home prepared fresh frozen foods are given on pages 9, 10 and 11.

If your freezer breaks down or the power fails, don't open the door and the frozen food won't be affected for up to 24 hours.

Any frozen food which thaws accidentally should be eaten as soon as possible or thrown away. Alternatively, if the food is uncooked and it has not completely defrosted it can be cooked then refrozen. (Note that some items must be thawed completely before cooking — see page 12).

Cooked food that has defrosted must never be refrozen.

Freezing fresh food

General information

In any 24 hours you can freeze as much as 15 kg (33 lb) of fresh food in your freezer. The method to adopt will depend on the weight of food to be frozen at one time:-

10 to 15 kg (22 to 33 lb)

Set the thermostat dial so that the indicator mark is against 'S' 24 hours *before* loading the food in the freezer. 24 hours after loading the food, return the dial to the required setting.

5 to 10 kg (11 to 22 lb)

Set the thermostat dial to 'S' as above, but load the fresh food in the freezer *immediately*. 24 hours later, return the dial to the required setting.

Up to 5 kg (11 lb)

There is no need to use the fast-freeze setting for small quantities, — simply load the food and leave for 24 hours to freeze.

The foods to be frozen should be prepared and packaged as described on the following pages and placed in the freezing compartment as given above, depending on weight. The packages should be in contact with the cooling surface as far as possible and spaced apart to allow cold air to circulate between them. They should not touch existing frozen food packages.

No harm will result if you forget to return the thermostat dial to it's normal setting after it has been in use but, for reasons of economy, try to remember to return it when freezing is complete, — the warning light should remind you of this.

If there is room, you can transfer the food you have frozen to other parts of the freezer allowing you to freeze a further load in the freezing compartment.

For safety reasons, the wire basket is fitted with stops but it can be removed by pulling it forward and lifting it at the front. Refit by reversing this procedure to engage the runners.

Practical Hints

Different foods need different methods of preparation and some will keep longer than others.

Of course, you can freeze practically anything, but don't waste space in your cabinet by storing foods which are readily available throughout the year.

Fruit is ideal — especially the softer varieties. But avoid pears because they lose their texture and discolour, and bananas, which will turn black.

Vegetables and herbs too are ideal, but salad vegetables and marrows are unsuitable because they contain too much water. Celery loses its crispness, so should be cooked first, and tomatoes are best frozen as purée. Onions should be chopped fine and frozen in small quantities.

All poultry, meat and fresh fish freeze well, as do baked goods, though for shorter periods.

As for prepared foods, these too can be frozen with confidence, but there are a few points to bear in mind.

Semi-liquid foods have a tendency to thicken, so should be made up a little slacker than normal. Highly spiced and aromatic dishes should be wrapped really thoroughly, so the flavour doesn't spread to your other frozen foods. Always cool them quickly and then freeze immediately.

General Preparation

For freezing purposes always choose the finest quality fresh foods.

Fruit & Vegetables

Fruit and vegetables should preferably be frozen immediately after harvesting or at least kept in a refrigerator for no longer than twenty-four hours. For perfect results fruit should be *just* ripe, and if any shows signs of being damaged it should be discarded. Most vegetables and some fruit need to be blanched before freezing to retard enzyme

Freezing fresh food (cont'd)

reaction. Timings for individual types are given in the detailed tables that appear later in this booklet.

Meat

Freeze joints in handy-sizes after removing waste such as bones, fat and so forth. Game must be hung for the desired period and cleaned *before* being frozen.

Fish

Should preferably be frozen within twenty-four hours of being caught. Any superfluous scale should be removed along with the fins, then the fish gutted and washed clean in cold salted water before being frozen.

Poultry

Gut, singe and wash birds thoroughly. Tie legs and wings to the body before placing in the freezer, or cut into joints for packing separately — gIBLETS should be packed separately, where possible.

Dairy Products & Baked Items

See individual details in tables which appear later in this booklet, page 11.

Prepared Foods

These freeze well, but remember that seasonings will become intensified during frozen storage, so be very sparing and add whatever you like when ready for eating. Salt actually shortens the storage time for all types of frozen foods, so add only a little during preparation.

Blanching

Where necessary, (see remarks column on page 10), plunge vegetables into boiling water for the specified period, timing from the moment of return to boil. Then drain and cool immediately in cold or iced water before packaging and freezing.

Packaging

Proper packing is one of the most important points about food freezing, if the true quality is to be preserved.

All food should be carefully wrapped in airtight moistureproof materials. It should be completely

covered and as much air as possible shut out to prevent 'freezer-burn' — those blemishes which appear on thawing.

The majority of materials you are likely to require will be readily obtainable from your own home freezer supplier, the larger stationery shops and department stores. Most useful are heavy gauge polythene bags or sheeting and plastic containers with tight-fitting lids — also the thicker kinds of aluminium foil.

As far as possible try to pack food in even shapes and sizes to maximise the space available in your freezer cabinet and facilitate removal when required at a later date.

Labelling

The self-adhesive type of label is probably the most useful as it can be used on every kind of surface. Each label should show clearly what kind of food is in the package, its approximate weight or likely number of servings, the date of initial storage and any comments relevant to ultimate use.

In addition, there is a slot in the front of the storage compartment covers which will accept the cards provided. These will provide handy reference to the contents of each compartment.

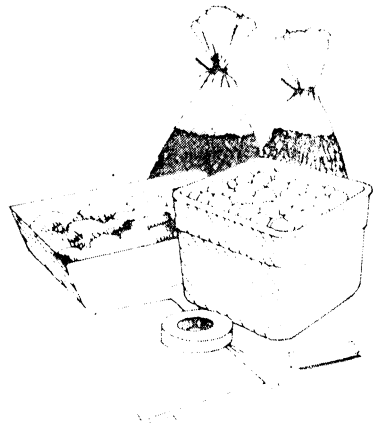

Freezing Foodstuffs — Individual Characteristics

	<i>Max. Storage Period</i>	<i>Method</i>	<i>Remarks</i>
MEAT joints			
Beef	10–12 months	Cut to handy size. Wrap thoroughly	
Pork	6–9 months	Cut to handy size. Wrap thoroughly	
Lamb	9–12 months	Cut to handy size. Wrap thoroughly	
Offcut Steak	10–12 months	Separate with cellophane layers	
Chops	see Pork or Lamb above	Separate with cellophane layers	Wrap carefully to protect against puncturing by sharp bones
Veal Fillets	6–9 months	Separate with cellophane layers	
Bacon, cured smoked	6 weeks 1 month	Separate with cellophane layers	Pack in handy meal portions
Sausages	6 weeks	Wrap tightly	Pack in handy meal portions
Minced meat	2 months	Wrap tightly	Pack in handy meal portions
Offal and tripe	3 months	Clean thoroughly. Pack in small portions	Make sure it is really fresh
POULTRY			
Chicken	9–12 months	Clean in usual way, joint if necessary	Wrap giblets separately — do not stuff till ready
Turkey	9–12 months	Clean in usual way, joint if necessary	
Duck, Goose	6 months	Clean in usual way, joint if necessary	
Giblets	3 months		Wrap separately from bird
GAME			
All types	6 months	Hang before freezing, prepare as for poultry	Cook immediately after thawing
FISH			
All types	3–6 months	Clean, discard head and tail, wrap separately	Must be fresh
Trout	4 months	Clean, discard head and tail, wrap separately	Must be fresh
Salmon	4 months	Clean, stuff with greaseproof paper for shape retention, or cut into steaks	Must be fresh
VEGETABLES			
Mushrooms	12 months	Wash, dry thoroughly. Freeze loose (or sauted in a little butter till partially cooked, then freeze)	Pack viable quantities in boxes

	<i>Max. Storage Period</i>	<i>Method</i>	<i>Remarks</i>
Potatoes	10 – 12 months	New potatoes and chips can be frozen raw. Otherwise cook partially in one of usual forms, cool then freeze	
Beans	12 months	Peel or pod, and wash	Blanch for 2 mins., cool for same time in iced water then freeze
Carrots	12 months	Use small ones. Prepare	Blanch for 5 mins.
Cauliflower	12 months	Break up into florets	Blanch for 3 mins.
Spinach	12 months	Wash thoroughly. Remove thicker veins	Blanch a few leaves at a time, for 2 mins.
Sprouts	12 months	Use only small ones. Remove outer leaves	Blanch for 3 mins.
Root crops	12 months	The younger the better. Peel and slice or freeze whole	Blanch for 3 mins.
FRUIT			
Apples	9 – 12 months	Freeze either of two ways: As purée-stew with little water, beat to smooth pulp, sweeten to taste, cool. OR Sliced-blanch for two minutes, drain and cool. Pack tightly in layers with a little dry sugar sprinkled between, if so desired; or soak in slightly salted water for ten minutes, dry and freeze	Freeze in small quantities. Pack in plastic containers, leaving ½" headroom ditto
Apricots	10 – 12 months	Preferably remove stones, but leave skins on. Pack in syrup ½ – 1 lb. sugar to 1 pint of water, making sure fruit is covered	Pack in plastic containers, leaving ½" – 1" headroom
Cherries	12 months	ditto	ditto
Damsons	12 months	ditto	ditto
Plums	9 months	ditto	ditto
Gooseberries	12 months	ditto	ditto
Blackberries	12 months	Either pack in syrup as above, or coat with caster sugar and pack in plastic containers. Also may be frozen loose: spread on trays allowed to freeze overnight and then packed in containers	ditto
Currants	12 months	ditto	ditto
Raspberries	12 months	ditto	ditto
Strawberries	12 months	ditto	ditto

	<i>Max. Storage Period</i>	<i>Method</i>	<i>Remarks</i>
Peaches	10 months	Cover with boiling water for 1 minute, then cool by dipping into cold and peel carefully. Cut into halves, removing stone. Use syrup method of packing and freezing	Keep fruit submerged in syrup; place crumpled greaseproof paper on top, so there is no room between the surface of the liquid and the lid
DAIRY PRODUCTS			
Egg Whites	10 months	Eggs must always be separated. Place whites in small containers just a few at a time	Eggs frozen in their shells will crack
Egg Yolks	10 months	As for whites, but to prevent coagulation mix with ½ tsp. salt or 1 tsp. caster sugar to every two yolks	Use for savoury or sweet dishes accordingly
Butter	6 months (unsalted) 3 months (salted)	Wrap bought butter in foil and freeze	
Cream Whipping and Double only	4 months	Must first be beaten lightly before freezing	Allow slight room for expansion in the container
Cheese	8 months (soft) 3 months (hard)	Wrap all varieties tightly in foil	Hard cheese stores much better when grated
BAKED ITEMS Wrap in foil or polythene bags			
Bread (Freshly baked)	1 – 2 months		
Cakes, plain	6 months	Just wrap and freeze	
Cakes, iced	3 months	Freeze without wrapping, then wrap and store in polythene	
PREPARED FOODS			
Stews	2 months	May be frozen quite satisfactorily in a polythene bag	
Sauces	4 months	Freeze in quantities of ½ pint. A little extra liquid may be required, when you come to use it	Egg based sauces are unsuitable
Full courses	3 months	Assemble individual helpings on specially constructed aluminium trays, then cover with foil. To re-heat leave the cover on and put in the oven for about 45 minutes at 400°F (200°C)	Cover slices of meat with gravy to prevent drying out

Thawing food

Thawing Food

Fruit

Keep container closed and allow to thaw at room temperature for about five hours.

Vegetables

No thawing needed — place in salted boiling water, cover and time cooking from moment of return to boil. It only takes a few minutes. Can also be put in the oven with a knob of butter. Chips and courgettes can go into hot fat.

Meat, Poultry etc.

Small jointed items don't require thawing before cooking, but always choose a moderate temperature and allow for a longer cooking time than normal so the meat cooks right through.

However, large items, such as a whole chicken must be thawed first; allow two to three hours per pound at room temperature, then proceed as usual.

Dairy Products

Allow eggs to thaw in closed containers and use immediately. Butter and cream will thaw in one to two hours at room temperature.

Baked Items

Bread takes about two hours to thaw or loaves may be heated in the oven. Cakes can be sliced in their frozen state to retain shape and speed the thawing process.

Prepared Foods

Heat gently in closed containers in the oven.

Commercial Packs

Simply follow the printed instructions.

The ice store

Ice making

The freezing compartment includes an ice store which enables you to build up a supply of ice cubes for a forthcoming party or spell of hot weather when ice will be in demand. The ice tray fits in the top of the ice store.

First, make ice cubes by filling the ice tray with fresh drinking water to the top of each ice cube compartment and placing the tray in the top of the ice store in the freezing compartment. For quicker ice-making, you can place the ice tray directly on the floor of the freezing compartment.

When ice cubes have formed, hold the tray upside down over the ice store and twist the tray along its length, allowing the loosened cubes to fall into the store.

Several makings of ice cubes can be accommodated and, of course, you can also leave the ice tray full of cubes, conveniently placed on top of the ice store.

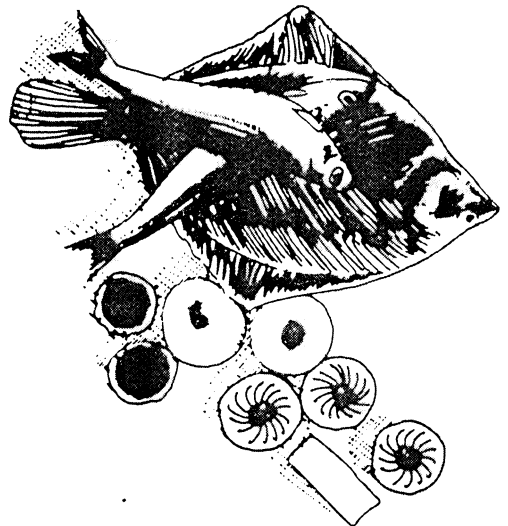

Important points to remember

DO . . .

adjust the level of your freezer before loading it with food, — see page 4.

keep a simple record of what you are storing, and remember to rotate stocks, — date markings will help with this.

disconnect from the wall socket and leave the door ajar when the freezer is not in use.

DON'T . . .

put hot food in the freezer.

put bottles or cans of fizzy drinks in the freezer.

give children iced lollies straight from the freezer, — they could cause frost burns.

attempt to freeze more than the maximum stated quantity of food in any 24 hours.

obstruct the air-flow under or over the freezer.

use a sharp instrument to remove frost as this could damage the cooling unit beyond economical repair.

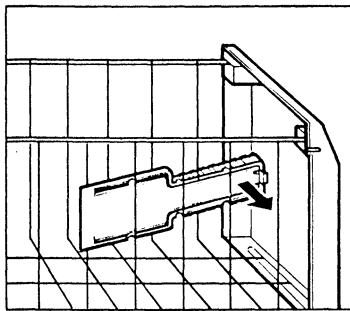

FIG 1

Looking after your freezer

How to defrost

Frost accumulates on the cooling surfaces during normal working and should occasionally be removed using the plastic scraper supplied (clipped to the inside of the bottom basket) (see fig 1).

Heavy frosting (about 1/4" thick) will reduce the freezer's efficiency and therefore complete defrosting should then be carried out, probably at 6 month intervals, depending on usage. Preferably you should do this when there is little or no food in the freezer, in the following manner:

1. Any remaining frozen food should be placed in another freezer, or in cardboard boxes and wrapped in blankets, layers of paper, or other suitable insulating material. Put in a cool place.
2. Remove the plastic scraper from its storage position on the inside of the bottom basket (see fig 1) and fit into the slot located in the centre of the bottom front of the cabinet (see fig 2). Place a suitable container under the spout to collect the defrost water.
3. Switch off at the wall socket, remove the plug, and leave the freezer door open.
4. Defrosting can be speeded up by putting bowls of hot (not boiling) water in the freezer and loosening the frost with the plastic scraper.
5. When defrosting is complete, remove plastic scraper and return to its storage position in the bottom basket.

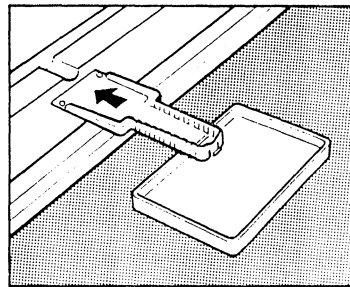

FIG 2

Changing over the door hinges

6. Clean and dry the interior as explained later under the heading "Cleaning", re-connect to the electricity supply and switch on. See that the thermostat dial is at the required setting and that the mains-on indicator light is on. Replace frozen food and close the door.

REMEMBER, if the temperature of frozen food is allowed to rise unduly during defrosting, its storage life may be shortened.

Cleaning

The most suitable time to clean your freezer is after defrosting. Remember to first switch off and pull out the plug.

The interior and fittings should be thoroughly cleaned with a clean cloth wrung out in a solution of one teaspoonful of bicarbonate of soda in each pint of water.

Never use neat detergents, abrasive powders, highly perfumed cleaning materials or wax polishes to clean the interior as these can damage the surfaces or leave a strong smell.

The outside of the freezer should be occasionally wiped over with a cloth or sponge dampened with a mild solution of detergent or soap.

A small amount of wax polish applied every few months will maintain the gloss finish of the outside.

The motor compressor and condenser at the rear should also be cleaned of dust occasionally using a brush, but make sure the freezer is unplugged when you do this.

Going on holiday?

Don't switch off at the mains if you intend to leave food in the freezer.

If you are leaving the freezer empty, switch off at the wall socket and remove the plug. Defrost, clean and dry, and **leave the door open, to avoid the build-up of stale odours inside the cabinet which will be difficult to remove on your return.**

To enable you to carry out this operation, the following tools are required:-

- Phillips Screwdriver
- Spanner
- Wide, flat headed screwdriver

Continue as follows:-

1. Empty the freezer, removing all loose items. If already in use, disconnect from the electricity supply.
2. Gently lay the cabinet on its back then remove the lower hinge (3) by taking out the two screws and lockwashers (2).
3. Carefully remove the door, disengaging it from the upper hinge pin.
4. Unscrew the upper hinge pin and transfer it to the opposite side.
5. Refit the door, engaging the top with the upper hinge pin in its new position.
6. Transfer the front foot (1) to the opposite side then refit the lower hinge (3) in its new position with the screws and lockwashers (2).
7. Stand the freezer upright. Prise out the plastic plugs from the alternative screw-holes for handle, protecting the paintwork while doing this with masking tape or something similar.
8. Remove the two screws from the handle. Remove the handle assembly together with support. Replace the plastic plugs in the vacant screw-holes and replace the handle on the opposite side of the door.
9. Install the freezer, levelling it as necessary with the adjustable feet (4). Check that the cold shield and thermostat knob are in their required positions before starting up.

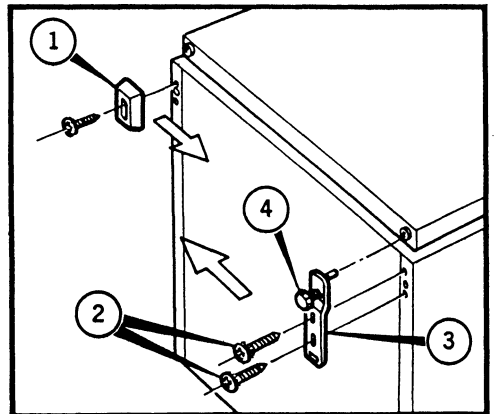

FIG 3

Installing under a worktop

Adjusting the worktop

Installing under a work surface

Should you wish to install the freezer under a worktop, it is important to provide sufficient clearance over the top of the freezer to allow proper ventilation of the cooling system.

The provision of a recess with minimum dimensions as shown in fig 4 will ensure satisfactory performance in normal kitchen temperatures.

Note: Do not use the area over the top of the freezer as a drying space for towels etc, as this will impede air flow and affect the performance of the freezer.

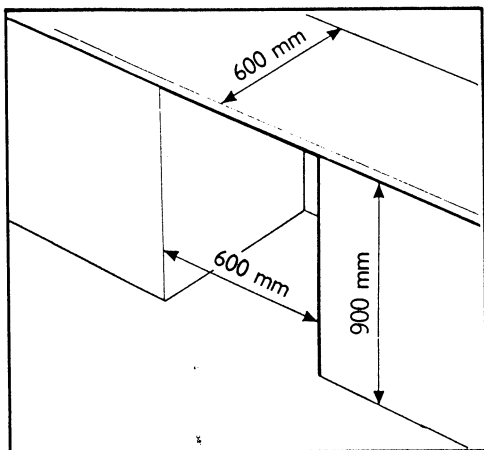

FIG 4

The worktop is normally aligned with the freezer door. However, it is adjustable and can be realigned to suit your own needs.

To do this proceed as follows:

1. Remove the two screws (A, Fig.5) securing the worktop at the rear.
2. Push the worktop to the required position and then refit the two fixing screws.

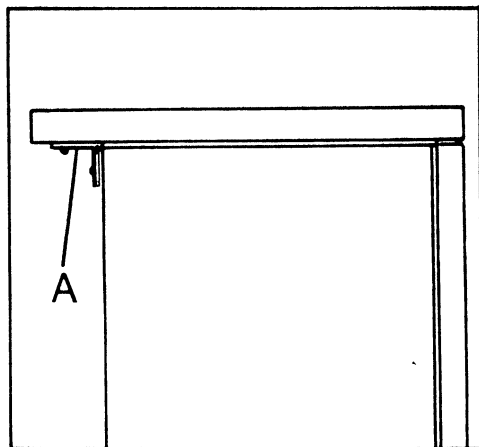

FIG 5

Something not working

Before you call for a Service Engineer, carry out these simple checks:

If your house supply is in order, is the freezer plug firmly connected to the wall socket, and is the socket still switched on? Try plugging in a table lamp or other appliance to see if power is available at the particular wall socket.

Is the fuse in the plug intact? If you have fitted your own plug, are the wires of the mains lead correctly connected? (See "Connecting to the mains", on page 4).

Have you turned the thermostat to the correct setting?

Has the door been left open causing the temperature to rise?

Sometimes the freezer door will be difficult to open shortly after you have closed it. Don't worry; this is due to a pressure difference which will quickly equalise and allow the door to open normally.

If after checking these points, your freezer still won't work, call your nearest Electrolux Service Shop or Office without delay. It is listed on page 18.

When calling, tell us your name, address with postcode, telephone number and what appears to be wrong. Also the Model number of your freezer and when and where you purchased it.

For future reference we suggest you record these details overleaf, and keep the receipt with the handbook as proof of purchase.

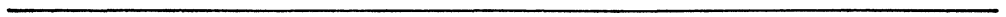

Guarantee

This Guarantee is offered to you as an extra benefit and does not affect your legal rights.

Electrolux products are carefully designed, manufactured, tested and inspected and in consequence we undertake to replace or repair any part found to be defective in material or workmanship, within one year of delivery to the original purchaser, free of charge.

ADDITIONALLY, DURING THE SUBSEQUENT FOUR YEARS, ANY DEFECTIVE PARTS WILL BE REPLACED FREE — LABOUR COSTS ONLY BEING CHARGEABLE.

The Company does not accept liability for defects arising from neglect, misuse, or accident.

There are certain conditions which may invalidate this guarantee:

- a) It is dependent upon the appliance being correctly installed and used in accordance with the Company's instructions under normal domestic conditions within the United Kingdom or the Republic of Ireland.
- b) Service at all times must be carried out by an Electrolux service representative or authorised agent.
- c) The guarantee may be invalidated by unauthorised repair or modification of the appliance.

Proof of the date of purchase will be required before service under guarantee is provided. Addresses or telephone numbers for service requests are listed on page 17.

We must point out that this guarantee does not cover liability for loss of food or other contents, but would draw your attention to the insurance facilities described on the separate leaflet.

Purchased from _____

Date Purchased _____

Model Number TF422 _____

SERVICE CENTRES

**NORTHERN IRELAND,
NORTH WEST and
SCOTLAND REGION**

Divisional Manager
Mr Les Dawes

Liverpool	051 220 8014
Belfast	0232 740 296
Glasgow	041 204 0411
Edinburgh	031 229 1232
Aberdeen	0224 695761

SCOTLAND – Local Office
Electrolux Service
20 Cunningham Road
Clyde Estate, Rutherglen
GLASGOW

N. IRELAND – Local Office
Electrolux Service
Unit C3, Edenderry Ind. Est.,
326 Crumlin Road
BELFAST, BT14 7EE

**NORTH MIDLANDS
REGION**

Divisional Manager
Mr Ray Britton

Birmingham	021 358 7076
Nottingham	0602 396927
Yorkshire	0532 608511
Gateshead	091 600440
Manchester	061 798 9689

NORTHERN DIVISION
Electrolux Service
P.O. Box 19
Altham Lane
Altham
Accrington, BB5 5XX

SOUTHERN REGION

Divisional Manager
Mr Norman Garland

Bristol	0272 211876
Cardiff	0222 489623
Southampton	0703 785231
Aldershot	0252 24505
Brighton	0273 694341
Maidstone	0622 677727
Jersey	0534 22138

SOUTHERN DIVISION
Electrolux Service
Hippodrome House
Birchett Road
ALDERSHOT, GU11 1LU

**LONDON & EASTERN
REGION**

Divisional Manager
Mr David Stephens

Luton	0582 575966
Norwich	0603 667018
Southend	0702 354313
North Thames area	01 965 9699
South Thames area	01 658 9069

LONDON & EASTERN DIVISION
Electrolux Service
Oakley Road
LUTON
Beds. LU4 9QQ

UPRIGHT FREEZER TF422 — A LUX MODEL, MADE IN ITALY

This appliance conforms to the requirements of
EEC Directive No. 82/499 relating to radio interference.



In accordance with its policy of progressive product design
the Company reserves the right to alter specifications.

T636

© Electrolux Ltd., 2/88

Publication N°. 822 00 06