



Electrolux

UPRIGHT FREEZER

TF180

TF182

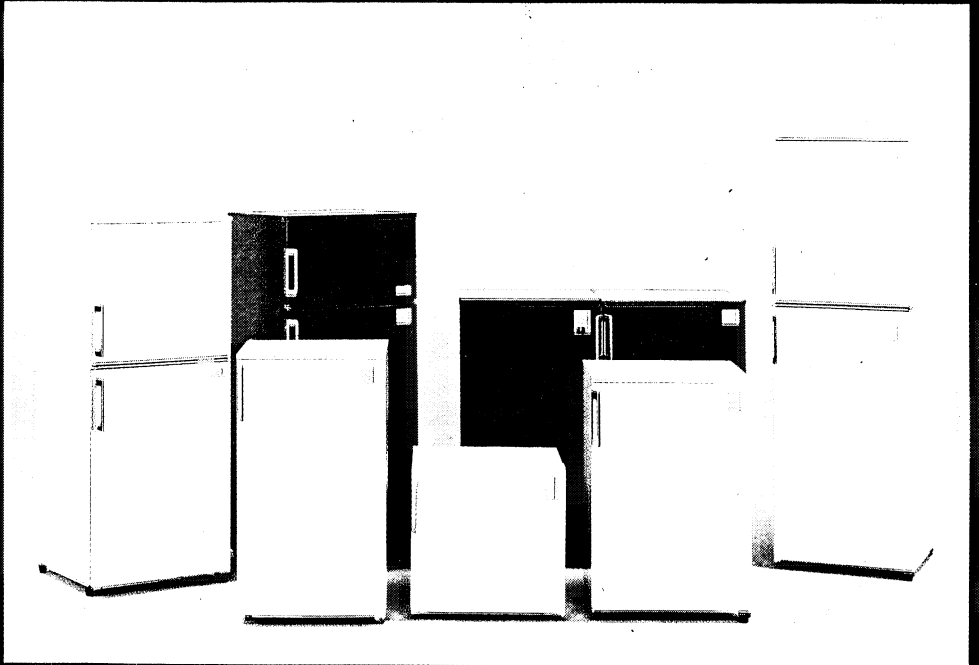

User's Handbook

Your new Electrolux freezer will store frozen food and freeze fresh food.

For best results, it's important that you read all the contents of this handbook before you use your freezer.

At first you may be aware of sounds in your kitchen which you are not used to, particularly if your freezer

is against sound-reflective surfaces such as tiled or painted walls. Please remember the cooling unit includes precision-built components which, like those in car engines and other machinery with fast moving parts, need a running-in period which may last several weeks. During this period, don't worry, — just allow the appliance time to settle down.

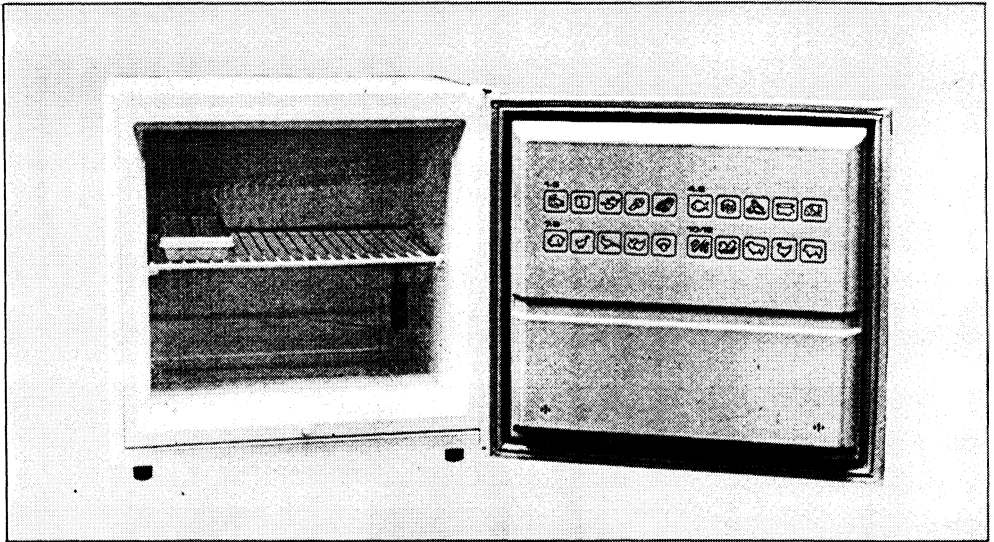

SAFETY NOTE

If this appliance is replacing an old refrigerator or freezer which is going to be scrapped, remove the door or lid before disposal to prevent children from becoming trapped inside.

About your freezer

Where to install it

Your new freezer can be stood on a table or refrigerator, or on another freezer provided that the surface on which it stands is large enough to safely contain the four feet and is strong enough to support the freezer full of food. Note that the thermostat knob is located at the rear of the right-hand side so make sure this will be accessible.

The chosen position may make it preferable to change over the hinges and door handle to reverse the door hang. To do this, refer to 'Changing over the door hinges' on page 13.

For the cooling unit to work efficiently, your freezer should be located in a dry atmosphere, out of direct sunlight and away from extreme temperatures, e.g. not next to a cooker or other sources of direct heat, or in a very cold room e.g. an outhouse, where the temperature may fall below 6°C (43°F).

Leave a clearance of at least 25mm (1 in) above the freezer and don't obstruct the space underneath.

The back of the freezer has two wall-stops, near the

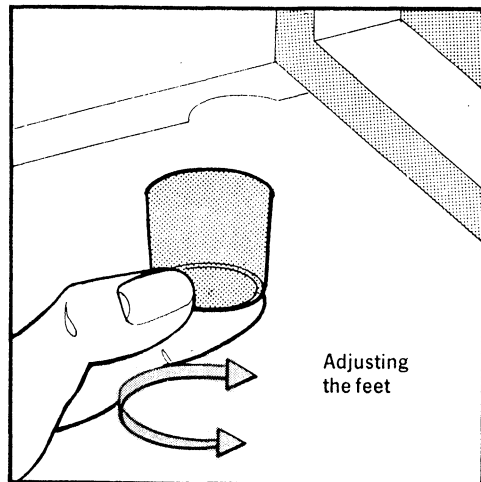

bottom, to prevent the cooling unit being too close to the wall. *Don't attempt to remove the wall-stops, or the feet, as the clearances provided by these are necessary for satisfactory ventilation.* The space between the top of the cabinet and the wall must also be kept clear.

Do not install your freezer in a pantry or in any other place with restricted ventilation.

Finally, make sure the freezer is standing level. If necessary, adjust by screwing out the appropriate feet so that it is level and does not rock in any direction.

Connecting to the mains

Before you use your freezer, check that the voltage shown on the data plate inside the cabinet conforms with your mains supply.

The mains lead of the freezer is fitted with a non-rewireable moulded-on 13 amp plug containing a 13 amp fuse. In the event of the fuse requiring replacement, the fuse cover/carrier should be removed, using a small screw driver to lever it out. The old fuse should be replaced by a 13 amp ASTA approved BS1362 fuse and the fuse cover/carrier *must* be refitted before the plug is used again.

If the fuse cover/carrier is lost, a replacement can be obtained from the Electrolux Service Shops and offices listed on page 15. The fuse cover/carrier must be of the same colour as that of the coloured insert in the base of the plug. **In no circumstances must the plug be used without a correct fuse cover/carrier fitted.**

If the plug supplied on the freezer mains lead is not suitable for the socket outlet in your home it should be cut off and disposed of safely, or destroyed, to avoid any possible shock hazard resulting from the plug being inserted into a 13 amp socket elsewhere in the house. A suitable replacement plug should be

Setting the control

Connecting to the mains (continued)

fitted as given below. (If a 13 amp plug and socket are not used, the circuit supplying the freezer should contain a 10 amp fuse).

WARNING —

THIS APPLIANCE MUST BE EARTHED.

IMPORTANT

The wires in the mains lead of this appliance are coloured in accordance with the following code:-

GREEN-and-YELLOW : EARTH
BLUE : NEUTRAL
BROWN : LIVE

As the colours of the wires in the mains lead may not correspond with the coloured markings identifying the terminals in your plug, proceed as follows:-

Connect the GREEN-and-YELLOW coloured wire to the plug terminal marked letter E or earth symbol \equiv or coloured green or green-and-yellow.

Connect the BROWN coloured wire to the plug terminal marked letter L or coloured red.

Connect the BLUE coloured wire to the plug terminal marked letter N or coloured black.

If at any time a replacement mains lead is required, the cross sectional area of its conductors must not be less than 0.75mm².

To start the cooling system, plug into the wall socket, switch on and turn the thermostat knob (on the right-hand side of the cabinet) to NORMAL.

The freezer temperature will be affected by location, room temperature and frequency of door opening, and adjustment of the thermostat setting may be needed to allow for this.

Temperature control

With the thermostat knob set to NORMAL, the temperature will be suitable for the long term storage of frozen food under most conditions of use. If colder temperatures are required, turn the knob clockwise, towards SUPER, or vice versa.

The required temperature inside the freezer is -18°C (0°F) or below.

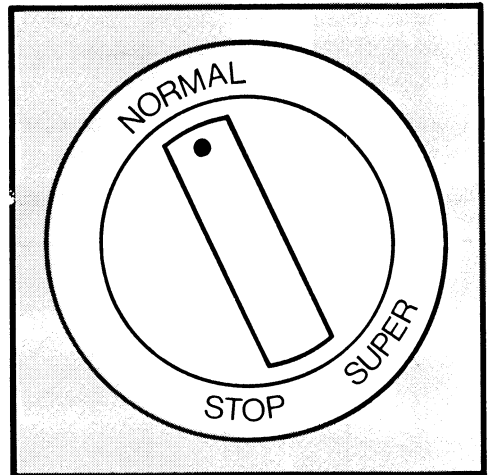

When operating, the outside front edges of the freezer may feel warm to the touch. This is quite normal.

We advise you to run your freezer for a day before storing frozen food.

Using the freezer

Freezing Fresh Food

The  symbol means that your freezer will store food at -18°C (0°F) for long term storage and will also freeze fresh food.

Storing frozen food

Your freezer has the following capacities:

Nett Storage Volume		*Weight of Stored Food	
litres	cubic ft	kg	lb
50	1.75	16	35

**This is a standard measurement and the actual capacity depends upon the density and sizes of food. The above figures are based on an average density of 0.32 kg per litre (20lb per cubic foot).*

Pre-packed commercially frozen food should be stored in accordance with the manufacturer's instructions for 3 star frozen food compartments and should be put into the freezer as soon as possible after purchase. Your freezer provides for long term storage which generally means up to 3 months but the length of storage time can vary and it is important to follow the recommended times shown on packets of commercially frozen food.

Storage times for home prepared fresh frozen foods are given on pages 8, 9 and 10.

If your freezer breaks down or the power fails, don't open the door and the frozen food won't be affected for up to 24 hours.

Any frozen food which thaws accidentally should be eaten as soon as possible or thrown away. Alternatively, if the food is uncooked and it has not completely defrosted it can be cooked then refrozen. (Note that some items must be thawed completely before cooking — see page 11).

Cooked food that has defrosted must never be refrozen.

General information

In any 24 hours you can freeze as much as 6 kg (13.2 lb) of fresh food in your freezer.

24 hours *before* loading the food, turn the thermostat knob to SUPER to lower the temperature in readiness for freezing.

Foods to be frozen should be prepared and packaged as described on the following pages then placed directly on the bottom of the freezer liner, — not on the shelf. The packets to be frozen should be in contact with the refrigerated surface as far as possible and spaced apart to allow cold air to circulate between them. They should not touch existing packets of frozen food.

During the freezing process, keep the door closed.

24 hours after placing the food in the freezer, return the thermostat knob to NORMAL.

No harm will result if you forget to turn back the knob, but, for reasons of economy, try to remember to turn it back when freezing is complete.

If there is room, you can transfer the food you have frozen to the shelf above to allow you to freeze a further load on the bottom of the liner.

Practical Hints

Different foods need different methods of preparation and some will keep longer than others.

Of course, you can freeze practically anything, but don't waste space in your cabinet by storing foods which are readily available throughout the year.

Fruit is ideal — especially the softer varieties. But avoid pears because they lose their texture and discolour, and bananas, which will turn black.

Vegetables and herbs too are ideal, but salad vegetables and marrows are unsuitable because they contain too much water. Celery loses its crispness, so should be cooked first, and tomatoes are best frozen as purée. Onions should be chopped fine and frozen in small quantities.

All poultry, meat and fresh fish freeze well, as do baked goods, though for shorter periods.

As for prepared foods, these too can be frozen with confidence, but there are a few points to bear in mind.

Semi-liquid foods have a tendency to thicken, so should be made up a little slacker than normal. Highly spiced and aromatic dishes should be wrapped really thoroughly, so the flavour doesn't spread to your other frozen foods. Always cool them quickly and then freeze immediately.

General Preparation

For freezing purposes always choose the finest quality fresh foods.

Fruit & Vegetables

Fruit and vegetables should preferably be frozen immediately after harvesting or at least kept in a refrigerator for no longer than twenty-four hours. For perfect results fruit should be *just* ripe, and if any shows signs of being damaged it should be discarded. Most vegetables and some fruit need to be blanched before freezing to retard enzyme reaction. Timings for individual types are given in the detailed tables that appear later in this booklet.

Meat

Freeze joints in handy-sizes after removing waste such as bones, fat and so forth. Game must be hung for the desired period and cleaned *before* being frozen.

Fish

Should preferably be frozen within twenty-four hours of being caught. Any superfluous scale should be removed along with the fins, then the fish gutted and washed clean in cold salted water before being frozen.

Poultry

Gut, singe and wash birds thoroughly. Tie legs and wings to the body before placing in the freezer, or cut into joints for packing separately — giblets should be packed separately, where possible.

Dairy Products & Baked Items

See individual details in tables which appear later in this booklet.

Prepared Foods

These freeze well, but remember that seasonings will become intensified during frozen storage, so be very sparing and add whatever you like when ready for eating. Salt actually shortens the storage time for all types of frozen foods, so add only a little during preparation.

Blanching

Where necessary, (see remarks column on page 9), plunge vegetables into boiling water for the specified period, timing from the moment of return to boil. Then drain and cool immediately in cold or iced water before packaging and freezing.

Packaging

Proper packing is one of the most important points about food freezing, if the true quality is to be preserved.

All food should be carefully wrapped in airtight moistureproof materials. It should be completely covered and as much air as possible shut out to prevent 'freezer-burn' — those blemishes which appear on thawing.

The majority of materials you are likely to require will be readily obtainable from your own home freezer supplier, the larger stationery shops and department stores. Most useful are heavy gauge polythene bags or sheeting and plastic containers with tight-fitting lids — also the thicker kinds of aluminium foil.

As far as possible try to pack food in even shapes and sizes to maximise the space available in your freezer cabinet and facilitate removal when required at a later date.

Labelling

The self-adhesive type of label is probably the most useful as it can be used on every kind of surface. Each label should show clearly what kind of food is in the package, its approximate weight or likely number of servings, the date of initial storage and any comments relevant to ultimate use.

In addition, keep a little notebook handy to enable you to rotate your stocks and check your family's requirements on a daily basis for future reference, so you can plan your household budget accordingly.

Ice Making

Fill the ice tray with water to the top of each ice cube compartment and place it on the bottom of the liner or on the shelf.

To release the ice cubes, twist the tray along its length.

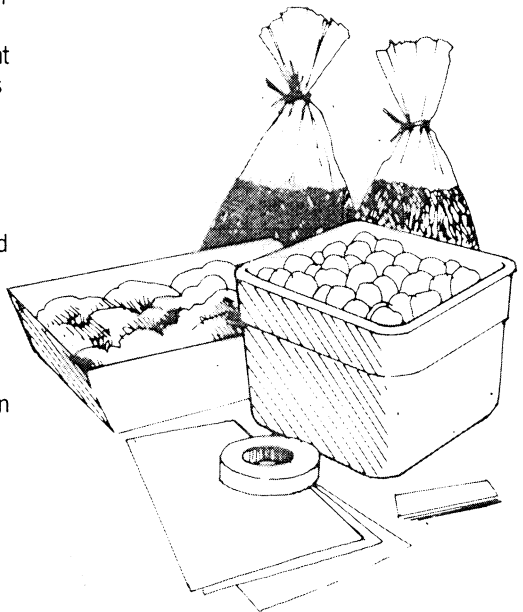

Freezing Foodstuffs — Individual Characteristics

	<i>Max. Storage Period</i>	<i>Method</i>	<i>Remarks</i>
MEAT joints			
Beef	10–12 months	Cut to handy size. Wrap thoroughly	
Pork	6–9 months	Cut to handy size. Wrap thoroughly	
Lamb	9–12 months	Cut to handy size. Wrap thoroughly	
Offcut Steak	10–12 months	Separate with cellophane layers	
Chops	see Pork or Lamb above	Separate with cellophane layers	Wrap carefully to protect against puncturing by sharp bones
Veal Fillets	6–9 months	Separate with cellophane layers	
Bacon, cured smoked	6 weeks 1 month	Separate with cellophane layers	Pack in handy meal portions
Sausages	6 weeks	Wrap tightly	Pack in handy meal portions
Minced meat	2 months	Wrap tightly	Pack in handy meal portions
Offal and tripe	3 months	Clean thoroughly. Pack in small portions	Make sure it is really fresh
POULTRY			
Chicken	9–12 months	Clean in usual way, joint if necessary	Wrap giblets separately — do not stuff till ready
Turkey	9–12 months	Clean in usual way, joint if necessary	
Duck, Goose	6 months	Clean in usual way, joint if necessary	
Giblets	3 months		Wrap separately from bird
GAME			
All types	6 months	Hang before freezing, prepare as for poultry	Cook immediately after thawing
FISH			
All types	3–6 months	Clean, discard head and tail, wrap separately	Must be fresh
Trout	4 months	Clean, discard head and tail, wrap separately	Must be fresh
Salmon	4 months	Clean, stuff with greaseproof paper for shape retention, or cut into steaks	Must be fresh
VEGETABLES			
Mushrooms	12 months	Wash, dry thoroughly. Freeze loose (or sauted in a little butter till partially cooked, then freeze)	Pack viable quantities in boxes

	<i>Max. Storage Period</i>	<i>Method</i>	<i>Remarks</i>
Potatoes	10 – 12 months	New potatoes and chips can be frozen raw. Otherwise cook partially in one of usual forms, cool then freeze	
Beans	12 months	Peel or pod, and wash	Blanch for 2 mins., cool for same time in iced water then freeze
Carrots	12 months	Use small ones. Prepare	Blanch for 5 mins.
Cauliflower	12 months	Break up into florets	Blanch for 3 mins.
Spinach	12 months	Wash thoroughly. Remove thicker veins	Blanch a few leaves at a time, for 2 mins.
Sprouts	12 months	Use only small ones. Remove outer leaves	Blanch for 3 mins.
Root crops	12 months	The younger the better. Peel and slice or freeze whole	Blanch for 3 mins.

FRUIT

Apples	9 – 12 months	Freeze either of two ways: As purée-stew with little water, beat to smooth pulp, sweeten to taste, cool. OR Sliced-blanch for two minutes, drain and cool. Pack tightly in layers with a little dry sugar sprinkled between, if so desired; or soak in slightly salted water for ten minutes, dry and freeze	Freeze in small quantities. Pack in plastic containers, leaving ½" headroom
Apricots	10 – 12 months	Preferably remove stones, but leave skins on. Pack in syrup ½ – 1 lb. sugar to 1 pint of water, making sure fruit is covered	Pack in plastic containers, leaving ½" – 1" headroom
Cherries	12 months	ditto	ditto
Damsons	12 months	ditto	ditto
Plums	9 months	ditto	ditto
Gooseberries	12 months	ditto	ditto
Blackberries	12 months	Either pack in syrup as above, or coat with caster sugar and pack in plastic containers. Also may be frozen loose: spread on trays allowed to freeze overnight and then packed in containers	ditto
Currants	12 months	ditto	ditto
Raspberries	12 months	ditto	ditto
Strawberries	12 months	ditto	ditto

	<i>Max. Storage Period</i>	<i>Method</i>	<i>Remarks</i>
Peaches	10 months	Cover with boiling water for 1 minute, then cool by dipping into cold and peel carefully. Cut into halves, removing stone. Use syrup method of packing and freezing	Keep fruit submerged in syrup; place crumpled greaseproof paper on top, so there is no room between the surface of the liquid and the lid

DAIRY PRODUCTS

Egg Whites	10 months	Eggs must always be separated. Place whites in small containers just a few at a time	Eggs frozen in their shells will crack
Egg Yolks	10 months	As for whites, but to prevent coagulation mix with ½ tsp. salt or 1 tsp. caster sugar to every two yolks	Use for savoury or sweet dishes accordingly
Butter	6 months (unsalted) 3 months (salted)	Wrap bought butter in foil and freeze	
Cream Whipping and Double only	4 months	Must first be beaten lightly before freezing	Allow slight room for expansion in the container
Cheese	8 months (soft) 3 months (hard)	Wrap all varieties tightly in foil	Hard cheese stores much better when grated

BAKED ITEMS Wrap in foil or polythene bags

Bread (Freshly baked)	1 – 2 months		
Cakes, plain	6 months	Just wrap and freeze	
Cakes, iced	3 months	Freeze without wrapping, then wrap and store in polythene	

PREPARED FOODS

Stews	2 months	May be frozen quite satisfactorily in a polythene bag	
Sauces	4 months	Freeze in quantities of ½ pint. A little extra liquid may be required, when you come to use it	Egg based sauces are unsuitable
Full courses	3 months	Assemble individual helpings on specially constructed aluminium trays, then cover with foil. To re-heat leave the cover on and put in the oven for about 45 minutes at 400°F (200°C)	Cover slices of meat with gravy to prevent drying out

Thawing food

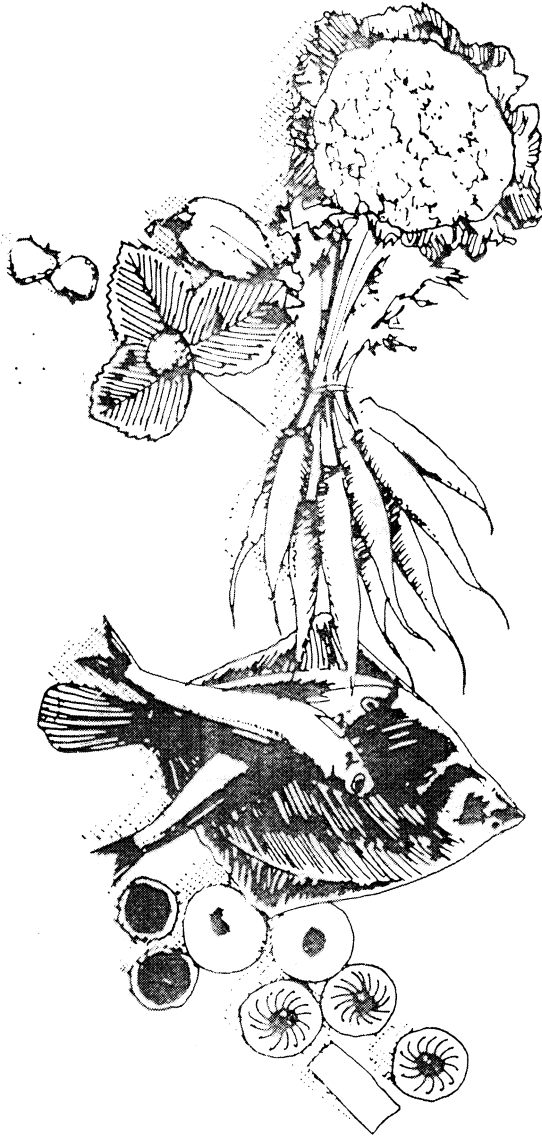

Thawing Food

Fruit

Keep container closed and allow to thaw at room temperature for about five hours.

Vegetables

No thawing needed — place in salted boiling water, cover and time cooking from moment of return to boil. It only takes a few minutes. Can also be put in the oven with a knob of butter. Chips and courgettes can go into hot fat.

Meat, Poultry etc.

Small jointed items don't require thawing before cooking, but always choose a moderate temperature and allow for a longer cooking time than normal so the meat cooks right through.

However, large items, such as a whole chicken must be thawed first; allow two to three hours per pound at room temperature, then proceed as usual.

Dairy Products

Allow eggs to thaw in closed containers and use immediately. Butter and cream will thaw in one to two hours at room temperature.

Baked Items

Bread takes about two hours to thaw or loaves may be heated in the oven. Cakes can be sliced in their frozen state to retain shape and speed the thawing process.

Prepared Foods

Heat gently in closed containers in the oven.

Commercial Packs

Simply follow the printed instructions.

Important points to remember

DO . . .

adjust the level of your freezer before loading it with food, — see page 3.

keep a simple record of what you are storing, and remember to rotate stocks, — date markings will help with this.

disconnect from the wall socket and leave the door ajar when the freezer is not in use.

DON'T . . .

put hot food in the freezer.

put bottles or cans of fizzy drinks in the freezer.

give children iced lollies straight from the freezer, — they could cause frost burns.

use a sharp instrument to hasten defrosting.

attempt to freeze more than the maximum stated quantity of food in any 24 hours.

Looking after your freezer

How to defrost

Frost accumulates on the refrigerated surfaces during normal working and should occasionally be removed using a plastic scraper or a stiff bristle brush.

Heavy frosting (about 1/4" thick) will reduce the freezer's efficiency and therefore complete defrosting should then be carried out, probably at 6 month intervals, depending on usage. Preferably you should do this when there is little or no food in the freezer in the following manner:

1. Any remaining frozen food should be placed in another freezer, or placed in cardboard boxes and wrapped in blankets, layers of paper, or other suitable insulating material. Put in a cool place.
2. Switch off at the wall socket and remove the plug.
3. Put a suitable container under the drain spout at the bottom front to collect the defrost water and leave the door open.

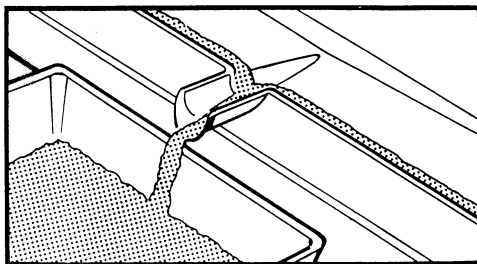

4. Defrosting can be speeded up by putting bowls of hot (not boiling) water in the freezer, loosening the frost with a stiff bristle brush or a plastic scraper.
5. After defrosting, clean and dry the interior as explained under "Cleaning", then replace the plug, switch on, replace any frozen food, and close the door. Check that the thermostat knob is at the correct setting.

Changing over the door hinges

REMEMBER, if the temperature of frozen food is allowed to rise unduly during defrosting, its storage life may be shortened.

Cleaning

The most suitable time to clean your freezer is after defrosting. Remember to first switch off and pull out the plug.

The interior and shelf should be thoroughly cleaned with a clean cloth wrung out in a solution of one teaspoonful of bicarbonate of soda in each pint of water.

Never use detergents, abrasive powders, highly perfumed cleaning materials or wax polishes to clean the interior as these will damage the surfaces or leave a strong smell.

The outside should be occasionally dusted or wiped over with a damp cloth and a small amount of detergent. But not the door seal, which should be cleaned only with soap and water and thoroughly dried.

A small amount of wax polish applied every few months will maintain the gloss finish of the outside.

The motor compressor and condenser at the rear should also be cleaned of dust occasionally using a brush, but make sure the freezer is unplugged when you do this.

Going on holiday

Don't switch off at the mains if you intend to leave food in the freezer.

If you are leaving the freezer empty, switch off at the wall socket, defrost, clean and dry, **and leave the door open**. This is to prevent the accumulation of odours in the cabinet when not in use.

1. If your freezer is already in use, disconnect it from the electricity supply. Remove loose items and temporarily store frozen food in boxes wrapped in blankets or other suitable insulating material.

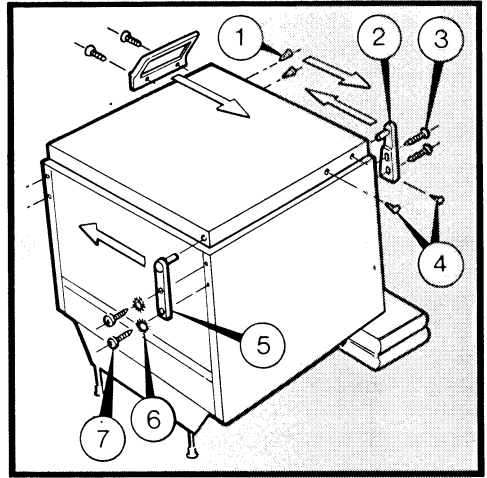

2. Gently lay the freezer on its back with the top held away from the floor with 2 or 3 inches of packing under its top edge. (Use old books or something similar).
3. Carefully prise out the two plastic plugs (1) from the alternative screw-holes in the cabinet top for the upper hinge. (Protect paintwork with masking tape or something similar while prising out the plugs).
4. Undo the screws (3) and (7) and transfer the hinges (2) and (5) to the opposite side, taking care not to lose the lock-washers (6) from the lower hinge-blade screws. Push the plastic plugs (1) into the vacated screw-holes in the cabinet top.
5. Stand the freezer upright and prise out the plastic plugs (4) from the alternative screw-holes for handle in the side of the door, protecting the paintwork as before.
6. Transfer the handle to its new position and push the plastic plugs into the vacated screw-holes.
7. Place the freezer where it is to be used and check that it is level in both directions. Adjust, if necessary, by screwing out the appropriate feet, — see page 3.

Something not working

Before you call for a Service Engineer, carry out these simple checks:

Is there a power failure? Check your house lights. If there is, keep the freezer door closed until the power is restored.

Is the plug firmly connected to the wall socket and the socket switched on? Check the power supply by plugging in another appliance.

Is the fuse in the plug intact? If you have fitted your own plug to the mains lead, are the wires correctly connected? (See "Connecting to the mains", on pages 3 and 4).

Have you turned the thermostat to the correct setting?

Has the door been left open causing the temperature to rise?

Sometimes the freezer door will be difficult to open shortly after you have closed it. Don't worry; this is due to a pressure difference which will quickly equalise and allow the door to open normally.

If after checking these points, your freezer still won't work, call your nearest Electrolux Service Shop or Office without delay. It is listed opposite.

When calling, tell us your name, address with postcode, telephone number and what appears to be wrong. Also the Model number of your freezer and when and where you purchased it.

For future reference we suggest you record these details here, and keep the receipt with the handbook as proof of purchase.

Purchased from _____

Date Purchased _____

Model Number TF180 _____

Electrolux Service Organisation

Should any breakdown occur with your appliance simply telephone your nearest Service Office or Service Shop, explain the nature of your problem and quote your Model number.

REGIONAL SERVICE OFFICES

Scotland & North Eastern Region

Electrolux Ltd., 5 Wellington Street, Glasgow G2 6JB.
041-204 0411

Northern Region (Inc. N. Ireland)

Electrolux Ltd., Altham Lane, Altham, Accrington, Lancs., BB5 5XY. Padiham 74621 (STD Code 0282)

Midlands & South Wales Region

Electrolux Ltd., 3 Strensham Hill, Moseley, Birmingham B13 8AQ.
021-449 5252

London Region

Electrolux Ltd.,
842 Coronation Road,
Park Royal, London NW10 7QA.
01-965 9699

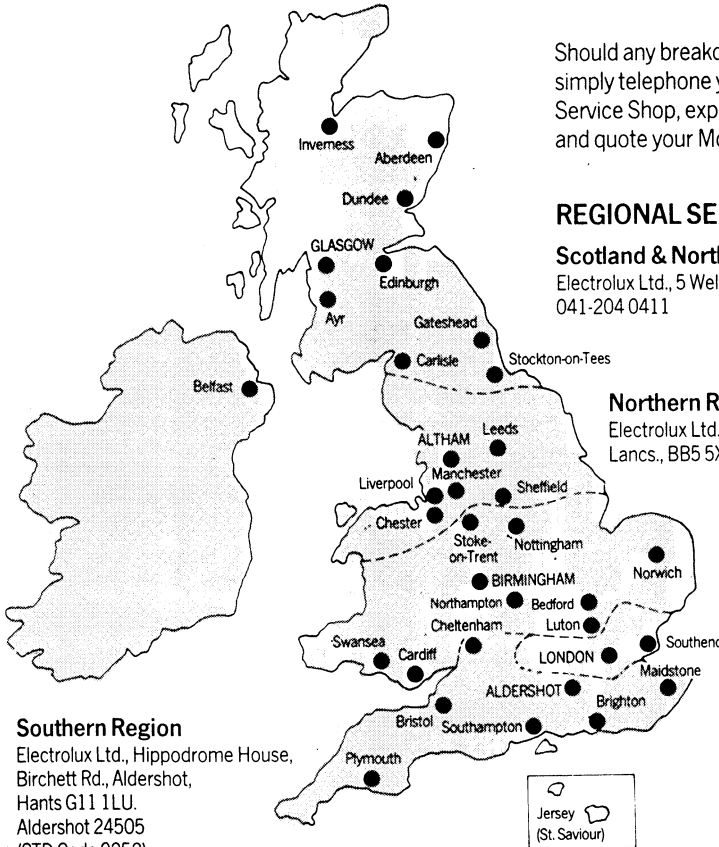

Southern Region

Electrolux Ltd., Hippodrome House,
Birchett Rd., Aldershot,
Hants G11 1LU.
Aldershot 24505
(STD Code 0252)

LOCAL SERVICE SHOPS

Aberdeen 695761 (STD Code 0224)
Ayr 262242 (STD Code 0292)
Bedford 219000 (STD Code 0234)
Belfast 740 296/7 (STD Code 0232)
Brighton 694341 (STD Code 0273)
Bristol 211876 (STD Code 0272)
Cardiff 387444 (STD Code 0222)
Carlisle 44568 (STD Code 0228)
Cheltenham 584051 (STD Code 0242)
Chester 312038 (STD Code 0244)
Dundee 22630 (STD Code 0382)
Edinburgh 031-229 1232
Gateshead 4600440 (STD Code 091)
High Wycombe 41042 (STD Code 0494)
Inverness 223056 (STD Code 0463)

Jersey (St Saviour) Central 22138
(STD Code 0534)

Leeds 608511 (STD Code 0532)
Liverpool 051-220 8014
Luton 575966 (STD Code 0582)
Maidstone 677727 (STD Code 0622)
Manchester 061-798 9689
Northampton 69222 (STD Code 0604)
Norwich 667017 (STD Code 0603)
Nottingham 396927 (STD Code 0602)
Plymouth 58161 (STD Code 0752)
Sheffield 338674 (STD Code 0742)
Southampton 785231 (STD Code 0703)
Southend 354313 (STD Code 0702)
Stockton-on-Tees 674848 (STD Code 0642)
Stoke-on-Trent 413414 (STD Code 0782)
Swansea 51848 (STD Code 0792)

Guarantee

This Guarantee is offered to you as an extra benefit and does not affect your legal rights.

Electrolux products are carefully designed, manufactured, tested and inspected and in consequence we undertake to replace or repair any part found to be defective in material or workmanship, within one year of delivery to the original purchaser, free of charge.

ADDITIONALLY, DURING THE SUBSEQUENT FOUR YEARS, ANY DEFECTIVE PARTS WILL BE REPLACED FREE — LABOUR COSTS ONLY BEING CHARGEABLE, provided that within 14 days of the purchase the Guarantee Registration card is returned to the Company and that service is carried out by an Electrolux service representative or authorised agent.

This guarantee is conditional upon the appliance being correctly installed and used in accordance with the Company's instructions under normal domestic conditions within the United Kingdom or the Republic of Ireland. It may however be invalidated by unauthorised repair or modification of the appliance.

The Company does not accept liability for defects arising from neglect, misuse, or accident.

Proof of the date of purchase will be required before service under guarantee is provided. Addresses or telephone numbers for service requests are listed on page 15.

We must point out that this guarantee does not cover liability for loss of food or other contents, but would draw your attention to the insurance facilities described on the separate leaflet.

UPRIGHT FREEZER TF180 — A LUX MODEL, MADE IN SPAIN

This appliance conforms with the requirements of EEC Directive No. 82/499 relating to radio interference.



ELECTROLUX LTD., LUTON, BEDS. LU4 9QQ

In accordance with its policy of progressive product design the Company reserves the right to alter specifications.

T532

© Electrolux Ltd., 7/85

Publication N°. 820 93 79