

EASYPULSE POC

Service Manual

Model PM4150 Series



Precision Medical, Inc.
300 Held Drive
Northampton, PA 18067 USA

Contents

Preface	1
Definition of terms	1
Safety information - Warnings and Cautions	1
Theory of Operation	2
Warnings and Cautions.....	3
Specifications:	4
Component Description	5
External.....	5
Internal	6
Maintenance / Cleaning.....	7
WARNINGS	7
Cabinet:	7
Inlet Filter:	7
Returns.....	7
Disposal Instructions.....	7
Troubleshooting.....	8
Alarm Indicators	9
Sieve Bed Assembly Replacement (505849):	10
Disassembly	10
Reassembly.....	11
Control Panel Replacement (505845):	12
Disassembly	12
Reassembly.....	13
PC Board Replacement (506729):	14
Disassembly	14
Reassembly.....	14
Internal Battery Replacement (507547):	15
Disassembly	15
Reassembly.....	15
Compressor Plate Assy Replacement (506320):	16
Disassembly	16
Reassembly.....	16
Checking the Oxygen Purity	17
To Put the EasyPulse POC in Test Mode.....	17

Preface

Precision Medical, Inc.
300 Held Drive
Northampton, PA 18067 USA

Customer Service / Tech Support
Phone: 1-610-262-6090
Phone: 1-800-272-7285
Fax: 1-610-262-6080
Web: www.precisionmedical.com

This manual is intended to guide and help a qualified service technician in the safe handling, service, and repair and performance verification of the PM4100 Series “EasyPulse POC” Portable Oxygen Concentrator. A qualified service technician should be trained in the safe handling of oxygen equipment and understand its inherent dangers.

DO NOT attempt to use or perform any service function on the PM4100 series POC unless you have read and understand this manual as well as the User Manual.

Definition of terms

POC Portable Oxygen Concentrator
GOX Gaseous Oxygen
OVP Operation Verification Procedure
AOVP Advanced Operation Verification Procedure

Safety information - Warnings and Cautions

DANGER	Indicates an imminently hazardous situation which, if not avoided, will result in death or serious injury.
WARNING	Indicates a potentially hazardous situation which, if not avoided, could result in death or serious injury.
CAUTION	Indicates a potentially hazardous situation which, if not avoided, may result in minor or moderate injury.

Theory of Operation

The EasyPulsePOC is intended to provide supplemental oxygen to the ambulatory oxygen patient in the smallest lightest package possible. Utilizing Precision Medical, Inc.'s patented Oxygen Conserving Technology, the EasyPulsePOC is a state of the art device, designed to be versatile and reliable.

This oxygen conserving technology delivers a true "pulse" of oxygen within the first 1/3 of the patient's inspiration and is unique in several additional ways. A true "pulse" is defined by a high peak flow (4 to 10 LPM) for a very short duration of time (0.2 to 0.4 seconds). It also controls the delivered minute volume which remains consistent between 15 and 35 BPM. The total oxygen volume (delivered minute volume) the patient receives is always the same, as the patient's breath rate decreases the pulse volume increases and conversely when breath rate increases.

The EasyPulse POC senses the patient's Inspiratory effort by means of a micro sensor. The sensor signals a micro valve to open for a specific duration based on setting, patient breathe rate and altitude delivering the bolus of oxygen to the patient. This all happens in less than 0.5 seconds. The delivered minute volume is controlled by the setting, the micro valve timing and the patient's breath rate.

Warnings and Cautions

WARNING

Oxygen supplied from this device is for supplemental use and is not intended to be life supporting or life sustaining. This device is not intended for use by patients who would suffer immediate, permanent, or serious health consequences as a result of an interruption in the oxygen supply.

- This device is NOT to be used by patients who breathe through their mouths.
- DO NOT smoke in an area where oxygen is being administered.
- DO NOT use near any type of flame or flammable/explosive substances, vapors or atmosphere.
- DO NOT use oils, greases, lubricants or any combustible materials on or near this product. Wash hands properly prior to usage.

TO AVOID INCREASED RISK OF FIRE

- Keep oxygen equipment away from open flames. Use and store the POC at least five (5) feet away from equipment such as furnaces, water heaters, and stoves that may contain open flames.
- Keep equipment in a well-ventilated area at all times.
- High concentrations of oxygen can cause rapid burning of other substances.
- DO NOT place blankets, draperies, or other fabrics over equipment.
- DO NOT use if dirt or contaminants are present on or around fill connectors on the POC.
- NO OXYGEN is delivered when the Pulse Selector is at the "Off" Setting.
- NO OXYGEN is delivered in between settings.
- DO NOT use while sleeping without consulting your Equipment provider.

CAUTION

- This device is designed to operate with a single lumen, adult, nasal cannula with a maximum length of 7 feet or less.
- Only individuals instructed and trained in its use should operate this device.
- Inspiratory efforts vary from patient to patient. The POC may not be able to detect respiratory efforts of all patients.
- This device contains magnetic, ferrous material that may affect the results of an MRI.
- DO NOT use liquid leak detector to test for leaks.
- DO NOT autoclave.
- DO NOT gas sterilize.
- DO NOT clean with aromatic hydrocarbons.
- DO NOT immerse device in any kind of liquid.
- Avoid dropping the device or placing it in a position where it could fall and become damaged.
- DO NOT block the outlet fitting or kink the cannula tubing when the device is in use.
- Store device in a clean area when not in use.
- Only use the Precision Medical carrying bag or carrying bag/backpack that is supplied from Precision Medical with the POC.

Specifications:

Dimensions:	Height: 10.1 in (25.7 cm) Width: 6.5 in (16.5 cm) Depth: 4.5 in (11.4 cm)
Weight:	6.8 lbs (3.08 kg)
Shipping Weight:	13.1 lbs (5.94 kg)
Altitude:	Sea level to 9000 ft (2743 m)
Operating Temperature:	41°F to 104°F (5°C to 40°C)
Storage / Transport Temperature:	-4°F to 140°F (-20°C to 60°C)
Operating / Storage / Transport Relative Humidity:	Up to 95% Non-Condensing
Oxygen Concentration:	87% to 95%
Start Up Time	87% O2 Concentration ≤ 10 min
Oxygen Minute Volume*:	
Setting 1:	240 +/-15% mL/min
Setting 2:	380 +/-15% mL/min
Setting 3:	520 +/-15% mL/min
Setting 4:	660 +/-15% mL/min
Setting 5:	780 +/-15% mL/min
Mode of Delivery:	Pulsed Dose only
Trigger Sensitivity:	0.50 cmH2O maximum
Trigger Delay:	0.11 seconds typical
Power:	AC Power Adapter: 100-240 VAC (1.0 A @ 120 VAC) DC Power Adapter: 11-16 VDC (5.0 A @ 12 VDC)
Battery Duration: (Approximate)	Setting 1: 4.5 hrs Setting 2: 3.2 hrs Setting 3: 2.5 hrs Setting 4: 1.8 hrs Setting 5: 1.5 hrs
Sound (@ Setting 2):	44 dBA
Cannula:	Maximum 7 ft (2.1 m) long standard adult single lumen nasal cannula.

Equipment Classification:

Class II - with respect to protection from electrical shock
Type BF - degree of protection against electrical shock
IPX1 - degree of protection against ingress of liquids
Mode of Operation - Continuous

Volatile Organic Compound (VOC) and Particulate Requirements:

The oxygen delivered from the EasyPulse POC meets the following requirements for particulate levels, VOC levels, carbon monoxide levels, carbon dioxide levels and ozone levels.

EPA PM2.5	Particulate Matter
ASTM D5466	Ozone Levels
21 CFR 801.415	Carbon Monoxide Levels
EPA NAAQS -	Carbon Monoxide Carbon Dioxide Levels

OSHA Permissible Exposure Limits

Standard Test Method for Determination of Volatile Organic Chemicals in Atmospheres
(Canister Sampling Methodology)

* At Sea level

Specifications are subject to change without prior notice.

Component Description

External

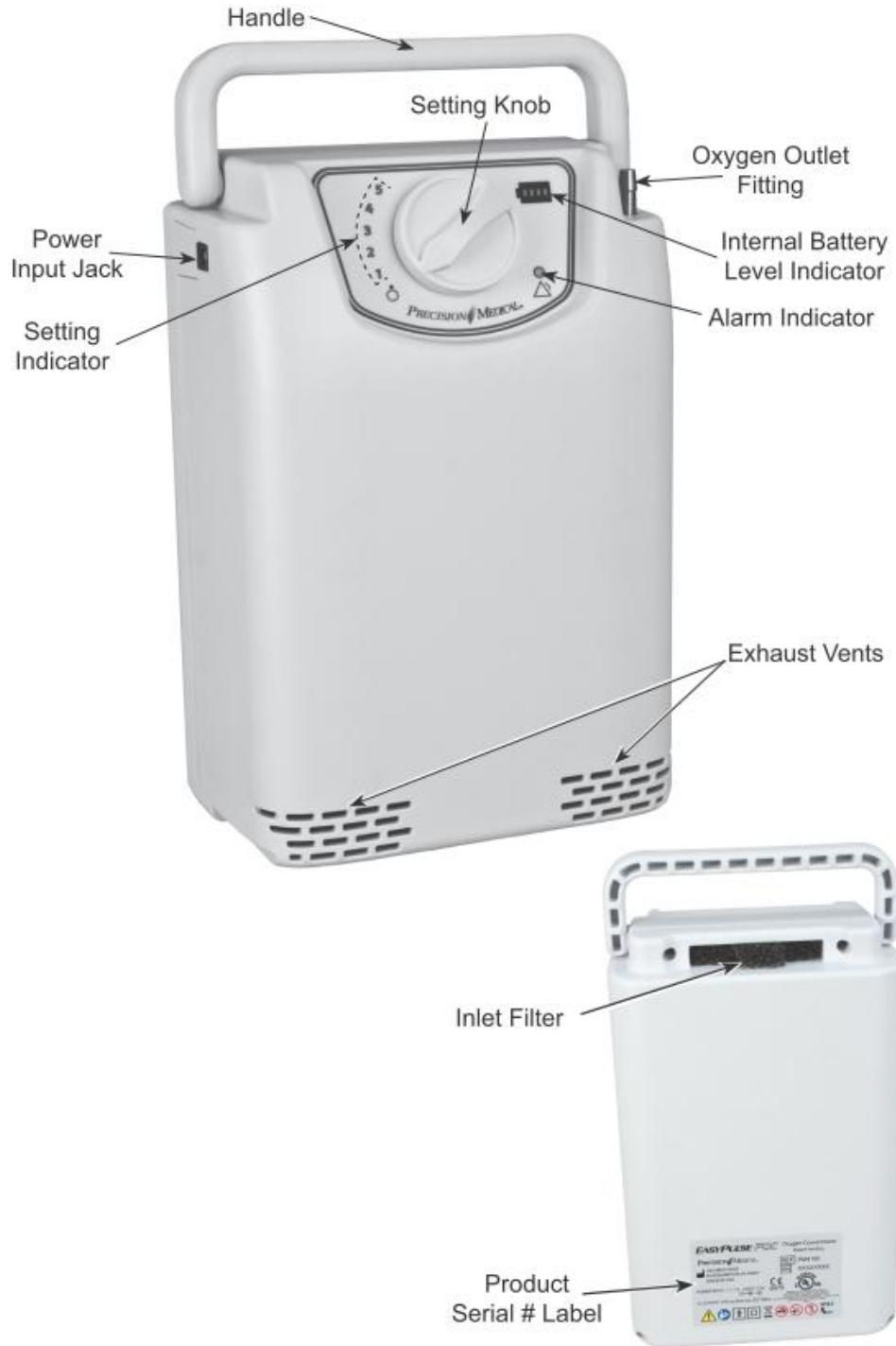

Internal

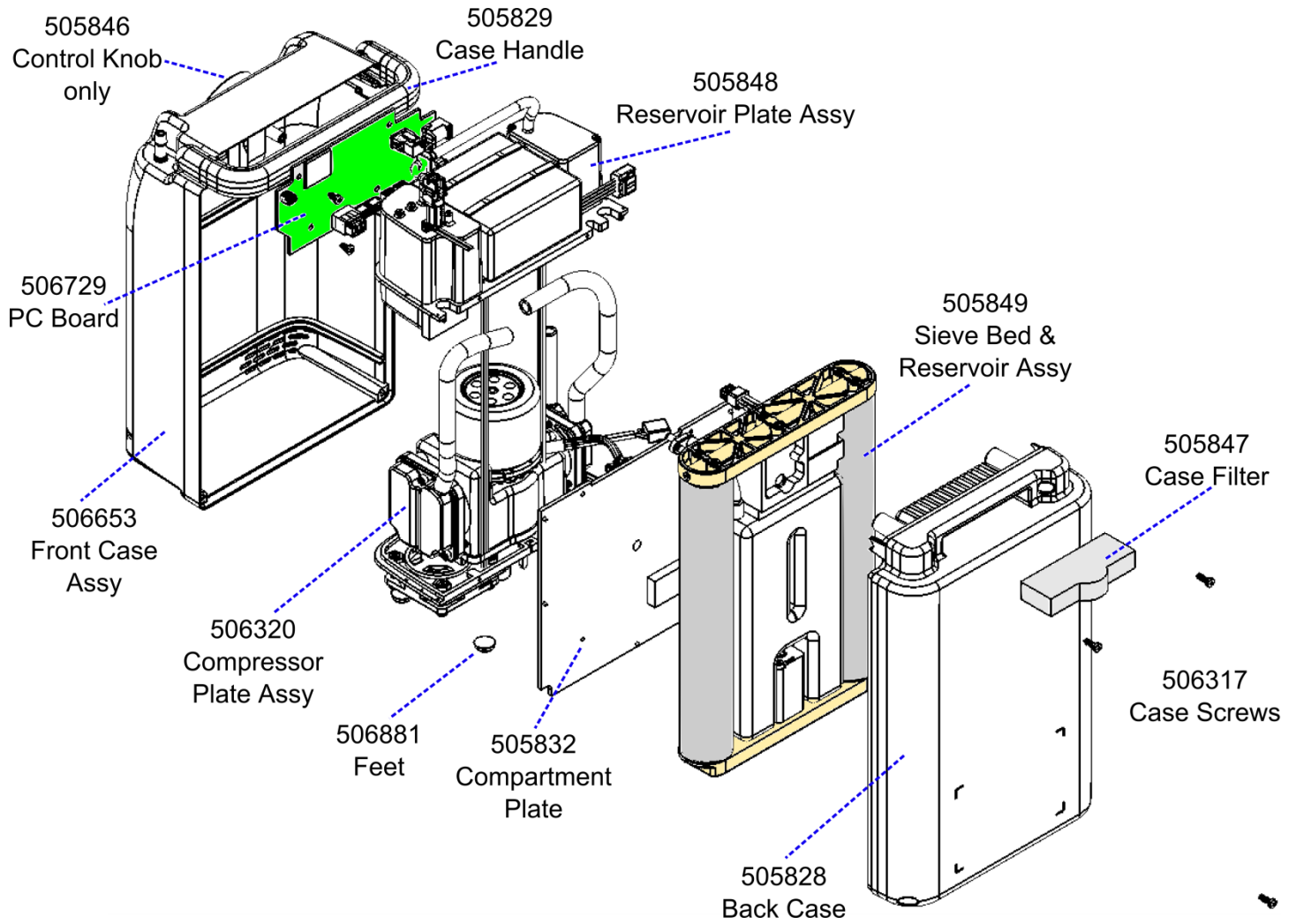

Maintenance / Cleaning

WARNINGS

- Prior to cleaning, ensure the POC is turned off and unplug any external power sources.
- DO NOT spray or apply any cleaners directly onto the case.
- DO NOT allow any liquids to drip inside any case openings.
- DO NOT use harsh and/or flammable chemicals to clean the device.

Perform cleaning as required.

Cabinet:

1. The patient should connect to an alternate Oxygen source.
2. Turn the POC to the "OFF" position.
3. Unplug the external power source before cleaning.
4. Clean exterior surfaces of the POC with a cloth dampened with disinfectant solution. Example: Sporidicin® Brand Disinfectant Solution.
5. Allow POC to air dry.
6. DO NOT place inside carry bag or run the POC until it is thoroughly dry.
7. When not in use, store the POC in a clean area free from grease, oil and other sources of contamination.

Inlet Filter:

1. Remove the inlet filter by pulling on the protruding tab.
2. Wash filter with mild detergent. Rinse thoroughly with water and allow to dry completely.
3. Once filter is dry, push the filter back into the case so only the small tab is protruding.

Returns

Returned products require a Returned Goods Authorization (RGA) number, contact Precision medical, Inc. All returns must be packaged in sealed containers to prevent damage. Precision medical, Inc. will not be responsible for goods damaged in transit. Refer to Precision medical, Inc. Return Policy available on the Internet, www.precisionmedical.com.

Manuals available on our Website; www.precisionmedical.com

Disposal Instructions



This device may contain electrical components that are hazardous to the environment. DO NOT dispose device into standard trash. Contact your local waste management for disposal of Electronic Equipment.



Troubleshooting

Visual Indicator/Problem	Audible Alarm	Probable Cause	Remedy
The last LED on the internal Battery Level Indicator turns red	Repetitive beep	Internal battery has dropped below 15% charge remaining	Connect the POC to the AC Power Adapter, DC Power Adapter, or external battery pack
The last LED on the internal Battery Level Indicator flashes red	Repetitive beep	Internal battery has dropped below 5% charge remaining	<ol style="list-style-type: none"> 1. Connect the POC to the AC Power Adapter, DC Power Adapter, or external battery pack 2. Change to alternate oxygen source if power source is not available
Amber alarm indicator is illuminated and setting number is not flashing during inhalation to signal a detected breath	Repetitive beep	No breath detected for 1 minute	<ol style="list-style-type: none"> 1. Verify the cannula is not kinked 2. Verify the cannula is properly connected to oxygen outlet 3. Verify the cannula is properly positioned in the nose
Red alarm indicator is illuminated and setting number is not flashing during inhalation to signal a detected breath	Repetitive beep	No breath detected for 2 minutes	<ol style="list-style-type: none"> 1. Verify the cannula is not kinked 2. Verify the cannula is properly connected to oxygen outlet 3. Verify the cannula is properly positioned in the nose 4. If alarm persists change to alternate oxygen source and contact your Equipment Provider
Amber alarm indicator is illuminated	Repetitive beep	Breath rate exceeding 35 breaths / minute	Reduce level of activity to allow breath rate to slow
Red alarm indicator is illuminated	Repetitive beep	Breath rate exceeding 35 breaths / minute for longer than 1 minute	<ol style="list-style-type: none"> 1. Reduce level of activity to allow breath rate to slow 2. If alarm persists, change to alternate oxygen source and contact your Equipment Provider
Red alarm indicator is illuminated, device is not running and setting numbers 1 & 2 are flashing	Repetitive beep	Abnormal compressor operation detected	<ol style="list-style-type: none"> 1. Turn the POC to the "Off" position. 2. Turn the POC back "ON" to prescribed setting 3. If alarm persists, change to alternate oxygen source and contact your Equipment Provider
Red alarm indicator is illuminated, device is not running and setting numbers 1 & 3 are flashing	Repetitive beep	Internal battery is outside its operating temperature range	<ol style="list-style-type: none"> 1. Turn off the POC and disconnect any power supplies 2. Check that the inlet filter is clean 3. Ensure inlet and exhaust vents are not blocked in any way 4. Verify you are operating the POC within the specified operating temperature range. 5. It may be necessary to allow the POC to warm up or cool before turning back "ON"
Red alarm indicator is illuminated, device is not running and setting numbers 1 & 4 are flashing	Repetitive beep	Motor is above its maximum operating temperature	<ol style="list-style-type: none"> 1. Turn off the POC 2. Check that the inlet filter is clean 3. Ensure inlet and exhaust vents are not blocked in any way 4. Verify you are operating the POC within the specified operating temperature range 5. It may be necessary to allow the POC to cool before turning back "ON"
Red alarm indicator is illuminated, device is not running and setting numbers 1 & 5 are flashing	Repetitive beep	Pressure outside of normal operation	<ol style="list-style-type: none"> 1. Turn the POC to the "Off" position 2. Turn the POC back "ON" to prescribed setting 3. If alarm persists, change to alternate oxygen source and contact your Equipment Provider
Red alarm indicator is illuminated, device is not running and setting numbers 2 & 3 are flashing	Repetitive beep	fan malfunction	<ol style="list-style-type: none"> 1. Turn the POC to the "Off" position 2. Turn the POC back "ON" to prescribed setting 3. If alarm persists, change to alternate oxygen source and contact your Equipment Provider
Red alarm indicator is illuminated, device is not running and setting numbers 2 & 4 are flashing	Repetitive beep	failed electrical connection	<ol style="list-style-type: none"> 1. Turn the POC to the "Off" position 2. Turn the POC back "ON" to prescribed setting 3. If alarm persists, change to alternate oxygen source and contact your Equipment Provider
Amber alarm indicator is flashing and device is running	NA	Service Needed	<ol style="list-style-type: none"> 1. Continue to use POC 2. Contact Equipment Provider
Red alarm indicator is flashing and device is running	NA	Service Needed	<ol style="list-style-type: none"> 1. Switch to another source of oxygen 2. Contact Equipment Provider

Alarm Indicators

	Green	Ready for use
	Amber	Caution - Prompt response by the OPERATOR is required
	Red	Warning - Immediate response by the OPERATOR is required

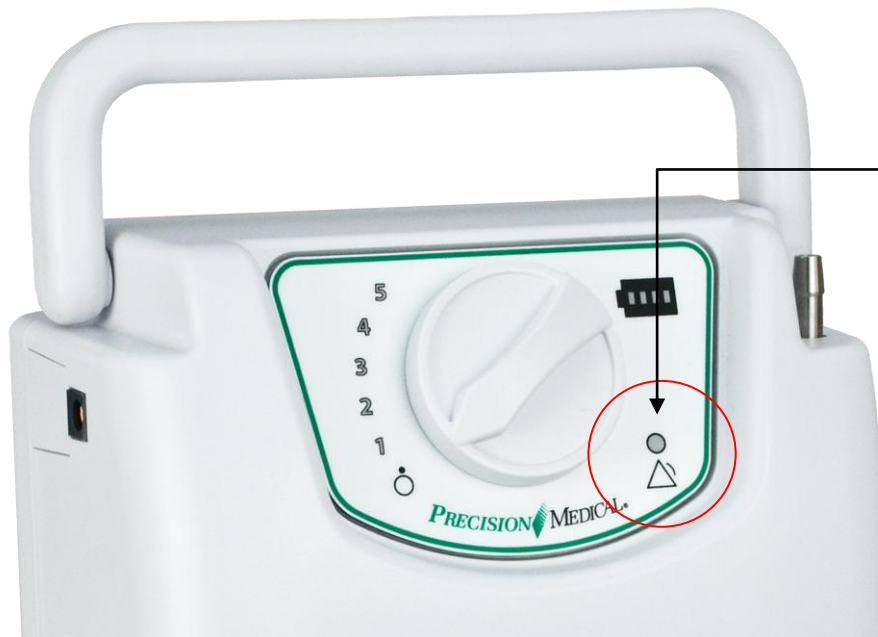

Sieve Bed Assembly Replacement (505849):

Tools and equipment required:

- #1 Phillips screwdriver
- Small diagonal wire cutters
- Needle nose pliers
- 3/16" (15mm) ID silicone tubing x 6 inch (15 cm) long (minimum)

Disassembly

1. Disconnect the POC from any external power source.
2. Ensure the device is set to the off position.
3. Lay the POC on to its front with the handle away from you.
4. Using a #1 Phillips screwdriver, remove the four screws from the back cover and set aside.
5. Remove the Back Cover by lifting up and off the Sieve Bed Assembly, set it aside as shown.
6. Stand the POC up. Remove the tubing clip from the right large Sieve Bed Tube as shown below.

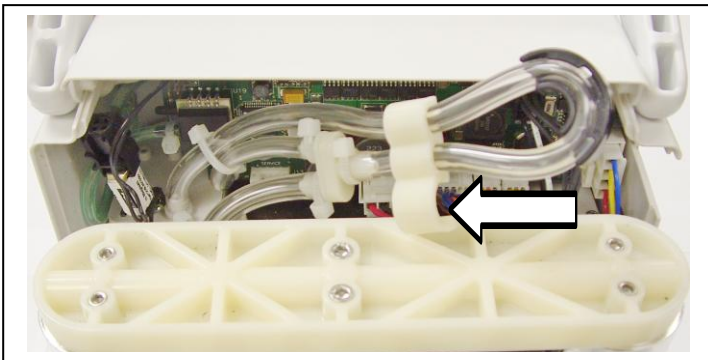

7. Using diagonal cutters carefully cut the Cable Ties securing the two (2) large Sieve Bed Tubes to the Sieve Bed Assembly as shown below and discard the old cable ties.

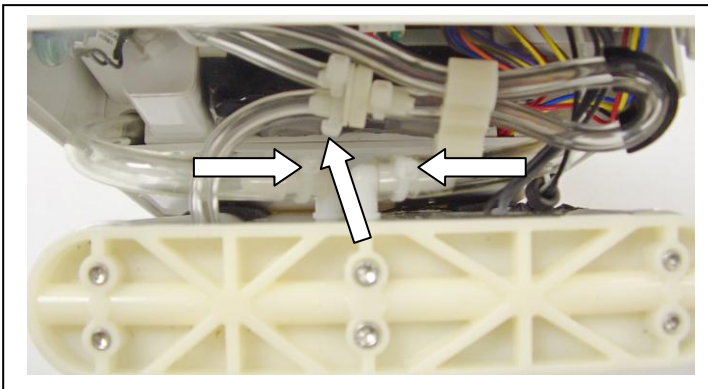

8. Carefully remove the two (2) large diameter Tubes from the Sieve Bed assembly.
9. Using the diagonal cutters cut the Cable Tie on the Tube connecting the Sieve Bed Assembly to the 'Y' Connector (as shown above) and remove the Tube from the 'Y' Connector.

STOP! From this point you must follow Electrostatic Discharge procedures to avoid damage to the electronic components.



10. Disconnect the small black 6 pin connector from the PC board and remove the sieve bed assembly from the POC as shown below.

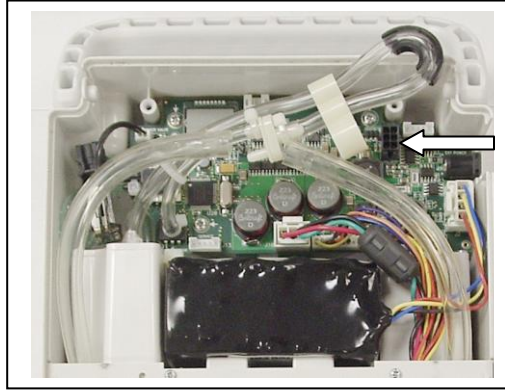

11. Attach a piece of 3/16" (15mm) tubing to each of the large tubing fittings on the sieve bed assembly as shown and set aside.

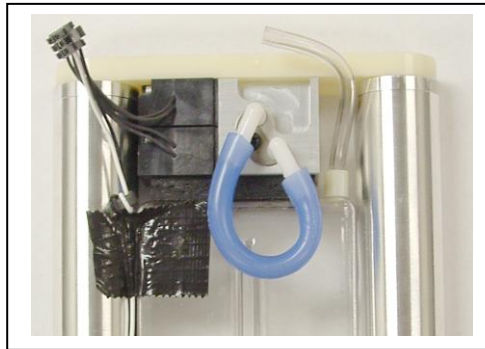

Reassembly

(Reference photos from the "Disassembly" section above)

1. Stand the POC up.
2. Remove the temporary Tube from the Sieve Bed Assembly.
3. Ensure the Elbow Fittings on the Sieve Bed Assembly are pointing away from one another.
4. Set the Sieve Bed Assembly into position.
5. Attach the large Tubes to the Sieve Bed Assembly, left Tube to the left Elbow, right Tube to the right Elbow, secure both with a Cable Ties.
6. Attach the small Tube from the Pressure Tank to the 'Y' Connector and secure with a Cable Tie.
7. Snap the Tubing Clamp on to the right side large Tube.
8. Connect the black 6 pin Connector to the PC board.
9. Lay the POC on to its front.
10. Position the Rear Cover over the Sieve Bed Assembly and slide into place.
11. Secure the Rear Cover with 4 screws.
12. Perform the Oxygen Purity Test to verify performance.

Control Panel Replacement (505845):

Tools and equipment required:

- #1 Phillips screwdriver
- Small flat blade screwdriver
- Small diagonal wire cutters
- Needle nose pliers
- 3/16" (15mm) ID silicone tubing x 6 inch (15 cm) long (minimum)
- ESD mat

Disassembly

1. Follow steps 1 thru 11 of the "Disassembly" section of the "Sieve Bed Replacement" in this manual.
2. Lay the POC on its front cover.
3. Carefully remove the large white 4 pin Battery Connector from the PC Board.
4. Carefully remove the large white 3 pin Motor Connector from the PC Board.
5. Carefully remove the small white 9 pin Motor Connector from the PC Board.
6. Carefully remove the two (2) small 3 pin Fan Connectors from the PC Board.
7. Fold the Wire Harness down and out of the way.
8. Using diagonal cutters carefully cut the Cable Tie securing the small Tube to the PC Board as shown below and discard the used Cable Tie.

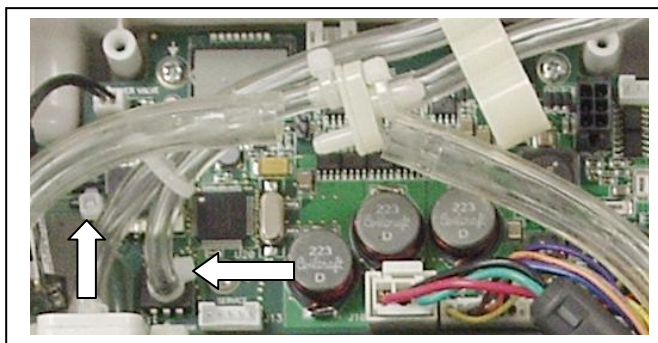
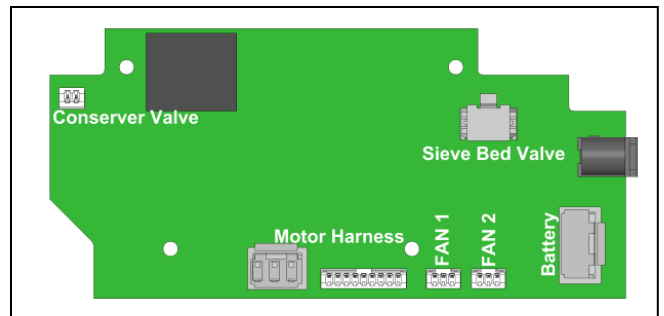

9. Disconnect the small Tube from the PC Board.
10. Using needle nose pliers carefully disconnect the small blue Tube from the cannula sensor on the PC Board as shown above.
11. Carefully disconnect the small 2 pin connector from the Conserver Valve from the PC Board as shown above.
12. Using a #1 Phillips screwdriver, remove the four (4) Screws securing the PC Board in place.
13. Carefully rotate the PC Board up to expose the ribbon cables as shown.
14. Release the Ribbon Cable connectors by sliding the clip away from the connector, disconnect both ribbon cables and remove the PC Board from the POC and place in a static free bag.
15. Using a small flat blade screwdriver, from the top of the control panel, carefully pry off the Control Knob and set aside.

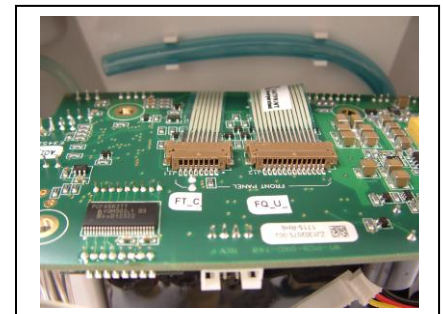

16. Using a small flat blade screwdriver, from the top of the control panel, carefully pry it away from the front POC housing until it releases. The control panel is attached to the housing with an adhesive backing.
17. When the adhesive has released remove the Control Panel and discard.

Reassembly

STOP! Be sure to follow Electrostatic Discharge procedures to avoid damage to electronic components

(Reference photos from the “Disassembly” section above)

1. Stand the POC up.
2. Remove the adhesive backing’s paper cover from the replacement Control Panel and feed the Ribbon Cable through the slots in the front POC housing and secure with the adhesive backing. Make sure the Control Panel is centered in its recess in the Housing.
3. Place the Control Knob that was removed from the old Control Panel onto the stem on the new Control Panel.
4. Ensure the Ribbon Cable connectors on the PC Board are in their open position.
5. Position the PC Board into the POC so the Ribbon Cables can be connected.
6. Using needle nose pliers gently grasp the narrow Ribbon Cable and slide into its corresponding Connector on the PC Board. Secure the Ribbon Cable in place by pushing the Connector latch down and onto the Ribbon Cable. You should hear a faint click.
7. Repeat steps 4 for the wide Ribbon Cable.
8. Carefully position the PC Board into place and secure with 4 Screws.
9. Connect the Conserver valve 2 pin Connector to the PC Board.
10. Using needle nose pliers, connect the small blue Tube to the Cannula Sensors outer Fitting on the PC Board.
11. Connect the small Tube from the Pressure Tank to the Pressure Sensor on the PC Board and secure with a Cable Tie.
12. Connect the two (2) small 3 pin Fan connectors to the PC board, orientation does not matter.
13. Connect the small white 9 pin Motor connector to the PC board.
14. Connect the large white 3 pin Motor connector to the PC board.
15. Connect the large 4 pin Battery connector to the PC Board.
16. Be sure the wires from the Pump are pushed down and into their original position.
17. Stand the POC up.
18. Follow steps 2 thru 12 of the “Reassembly” section of the “Sieve Bed Replacement” in this manual.



PC Board Replacement (506729):

Tools and equipment required:

#1 Phillips screwdriver

Small diagonal wire cutters

Needle nose pliers

3/16" (15mm) ID silicone tubing x 6 inch (15 cm) long (minimum)

ESD mate

Disassembly

1. Follow steps 1 thru 11 of the "Disassembly" section of the "Sieve Bed Replacement" in this manual.
2. Follow steps 2 thru 14 of the "Disassembly" section of the "Control Panel Replacement" in this manual.

Reassembly

1. Follow steps 4 thru 16 of the "Reassembly" section of the "Control Panel Replacement" in this manual.
2. Follow steps 2 thru 12 of the "Reassembly" section of the "Sieve Bed Replacement" in this manual.

Internal Battery Replacement (507547):

Tools and equipment required:

- #1 Phillips screwdriver
- Small diagonal wire cutters
- Needle nose pliers
- 3/16" (15mm) ID silicone tubing x 6 inch (15 cm) long (minimum)

Disassembly

1. Follow steps 1 thru 11 of the "Disassembly" section of the "Sieve Bed Replacement" in this manual.
2. Follow Steps 2 thru 7 of the "Disassembly" section of the "Control Panel Replacement" in this manual.
3. Remove the 4 Screws securing Pump Compartment Cover and set aside
4. Using diagonal cutters cut the Cable Tie that secures the large rear Tube connecting the Inlet Muffler to the Pump and remove the Tube from the Inlet Muffler.
5. Slide the Pump/Fan Assembly out of the POC, set aside.
6. Using diagonal cutters, cut the two (2) Cable Ties securing the Battery to the Battery Shelf as shown and discard.

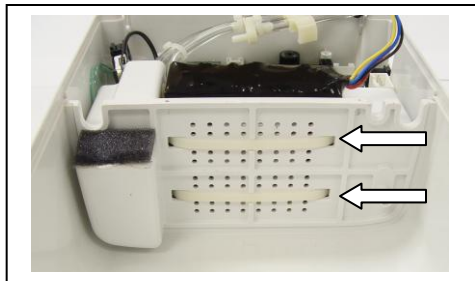
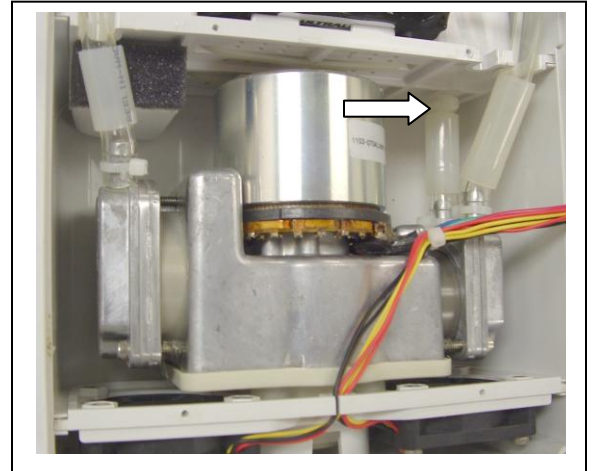

7. Remove the battery and dispose of in accordance to local recycling requirements.

Reassembly

(Reference photos from the "Disassembly" section above)

1. From the bottom of the Battery Shelf, feed the Cable Tie up and through the rear right slot in the Shelf, and back through the rear left slot in the Shelf.
2. Engage the cable tie into itself about 1 inch (25mm).
3. Position replacement Battery so the wires are to the upper right corner.
4. Slide the Battery down into position in the POC and through the Cable Ties.
5. Tighten the rear Cable Tie so that the latch is positions on the left side of the Battery Shelf.
6. Tighten the front Cable Tie so that the latch is positions on the left side of the Battery Shelf.
7. Ensure the Battery is properly secured, trim off the excess Cable Tie.
8. Start to secure a Cable Tie and slide it over the large rear Tube on the pump.
9. Position the Pump/Fan assembly into the POC by sliding it into its corresponding slot.
10. Using needle nose pliers connect the rear large Tube from the Pump to the Inlet Muffler.

11. Ensure the large Tube is completely engaged on to the Inlet Muffler Fitting and the Pump is straight in the POC.
12. Secure the Cable Tie on the large rear Tube from the Pump on to the Inlet Muffler Fitting, trim off the excess Cable Tie.
13. Position the large Tubes and the Wire Harness into their corresponding Slots in the Battery Shelf.
14. Position the Pump Compartment Cover into position and secure with the 4 screws.
15. Follow steps 11 thru 15 of the “Reassembly” section of the “Control Panel Replacement” in this manual.
16. Stand the POC up.
17. Follow steps 2 thru 12 of the “Reassembly” section of the “Sieve Bed Replacement” in this manual.

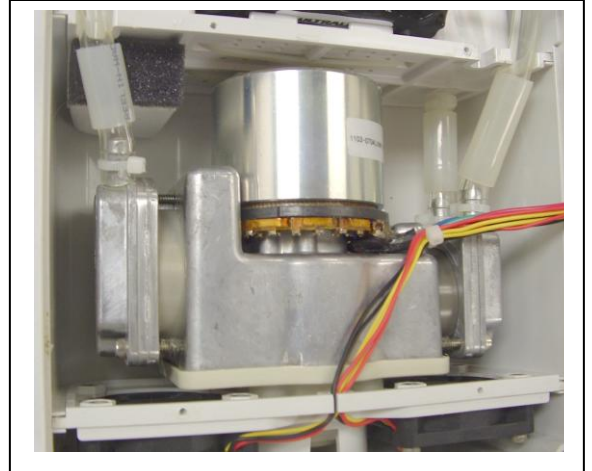

Compressor Plate Assy Replacement (506320):

Tools and equipment required:

- #1 Phillips screwdriver
- Small diagonal wire cutters
- Needle nose pliers
- 3/16" (15mm) ID silicone tubing x 6 inch (15 cm) long (minimum)

Disassembly

1. Follow steps 1 thru 11 of the “Disassembly” section of the “Sieve Bed Replacement” in this manual.
2. Follow Steps 2 thru 7 of the “Disassembly” section of the “Control Panel Replacement” in this manual.
3. Fold the large Tubes coming from the Pump down and out of the way.
4. Using diagonal cutters cut the Cable Tie that secures the large rear Tube connecting the Inlet Muffler to the Pump and remove the Tube from the Inlet Muffler.
5. Slide the Pump/Fan Assembly up and out of the POC.

Reassembly

1. Follow steps 9 thru 16 of the “Reassembly” section of the “Internal Battery Replacement” in this manual.
2. Follow steps 2 thru 12 of the “Reassembly” section of the “Sieve Bed Replacement” in this manual

Checking the Oxygen Purity

To Put the EasyPulse POC in Test Mode

***It is very important to remove any external power source and allow the device to sit for at least 15 seconds before attempting to put in to the test mode.**

***Do not block the outlet while in the test mode. Damage to the device may occur and is not covered under warranty.**

1. Attach the EasyPulse POC to the oxygen purity test device
2. Remove all external power sources
3. Turn device off for 15 seconds
4. Then, like a combination lock, turn dial to: 5, then 1, then 3, then off.
5. Turn device to any flow setting. Device will continuously pulse.
6. The alarm LED on the front will blink yellow and red while in test mode. (Steps 3 & 4 must be completed within 8 seconds)
7. Attach any external power source if needed.
8. In this mode, you can go to any flow setting and test oxygen purity. The device will pulse as if it was attached to a simulator breathing 20 breaths per minute.
9. To return device to normal function, turn dial to off position. Once the device is turned to the off position, you will need to go through the above steps to get the device back into the test mode.

