



# Featheride™

Light Duty Trailer Air Suspension  
8,000 lb.cap.

## Installation and Service Manual



Ridewell Corporation ♦ P.O. Box 4586 ♦ Springfield, MO 65808-4586  
800-641-4122, (417) 833-4565 ♦ Fax (417) 833-4560 ♦ [www.ridewellcorp.com](http://www.ridewellcorp.com)

12/08

# CONTENTS

- **BASIC DESIGN, pg. 3**
  - FEATURES
  - AIR SPRING & HEIGHT CONTROL VALVE FUNCTION
  - AIR PRESSURE REQUIREMENTS
  
- **SUSPENSION INSTALLATION, pgs. 4-13**
  - FRAME CROSS MEMBER REQUIREMENTS
  - HANGER AND PIPE FITUP & WELDING
  - AXLE AND BEAM FITUP
  - AXLE WELDING
  - HANGER AND AXLE PLACEMENT
  - AIR SPRING INSTALLATION
  - AXLE ALIGNMENT
  
- **AIR CONTROL SYSTEM INSTALLATION, pgs. 14-16**
  - AIR TANK
  - AIR COMPRESSOR
  - HEIGHT CONTROL VALVE (HCV)
  - AIR SPRING CONNECTIONS
  
- **QUALITY INSPECTION, pg.17**
  - WELDS / PIVOT WASHERS
  - TIRE CLEARANCES
  - WHEEL ALIGNMENT
  - HCV / AIR LINES AND SPRINGS
  - RIDE HEIGHT
  
- **PREVENTIVE MAINTENANCE, pg. 18**
  - DAILY
  - EVERY 30 DAYS OF OPERATION
  - EVERY 90 DAYS OF OPERATION
  
- **DRAWINGS AND PARTS EXPLOSION, pgs. 19-22**
  - SUSPENSION INSTALLATION
  - PARTS EXPLOSION
  - AIR CONTROL KIT INSTALLATION

## NOTICE

**Suspension Identification:** Ridewell Suspensions are identified by a metal tag that indicates part number, capacity and serial number. Consult your trailer manufacturer for your correct mounting height.

**Parts:** For optimum suspension performance, order only Ridewell parts as shown on pages 19-20.

**Sales, Service & Warranty:** If you need assistance regarding this product, please contact us and we will be glad to help you.

**Mailing Address:** Ridewell Corporation P.O. Box 4586 Springfield, MO 65808

**Shipping Address:** Ridewell Corporation 3715 E. Farm Rd. 94 Springfield, MO 65803

**Phones:** 800-641-4122, (417) 833-4565 **Fax:** (417) 833-4560 **email:** info@ridewellcorp.com

**www.ridewellcorp.com**

# *Featheride*<sup>™</sup> BASIC DESIGN

When properly maintained and operated within design limits, the Featheride<sup>™</sup> Suspension will provide many years of trouble-free service. It has several unique features which keep maintenance and downtime to an absolute minimum:

- 1 - A patented, contoured weld-on axle seat that requires no U-bolts.
- 2 - A longer hanger that improves geometry between pivot bushing, axle, and air spring.
- 3 - A self contained shock absorber to ease installation and insure proper shock and air spring design.
- 4 - A slotted hanger for easy axle alignment.

## **AIR SPRINGS & HEIGHT CONTROL VALVE**

This air-ride suspension is designed to dampen the shocks transmitted from the road surface to the trailer frame through the AIR SPRINGS. The HEIGHT CONTROL VALVE is used to maintain the proper ride height from air spring to chassis (whether empty or loaded) by exhausting or adding to the volume of air in the springs. A manual or electronic dump valve may be incorporated that will exhaust air to lower the trailer when loading or unloading. Please check with your trailer manufacturer for your suspension's ride height.

**IMPORTANT NOTE:** The air springs used on the Featheride<sup>™</sup> Suspension have internal rubber bumpers, should an air spring fail. If one spring fails both will deflate allowing the suspension to operate on internal bumpers until repairs can be made.

## **AIR PRESSURE REQUIREMENTS**

The air control kit outlined in this manual comes with a pressure switch. This switch kicks on the compressor around 80psi and kicks off at 100psi. A schrader valve on the tank can be used to initially fill up the tank and limit compressor run time. Note: The air springs will require 60psi for 8000 pound axle rating.

# Suspension Installation

**Note:** Use a pry bar and move beam pivot as far back as possible to assure the beam pivot is at the backside of the hanger adjustment slot. Do this on all hanger beam assemblies.



Block up the front and back of beam on flat surface. Insert hanger pipe cross member, customer furnished 1.5" Sch 40 pipe. Pipe can be precut at 1/2" longer than frame width (angle style frames), or cut off after welding in place. The 1/2" extra is for fillet welding of pipe and hanger side. Space outside to outside of hangers at frame width. Clamp angle squarely onto the back of beam to assure beams are level.

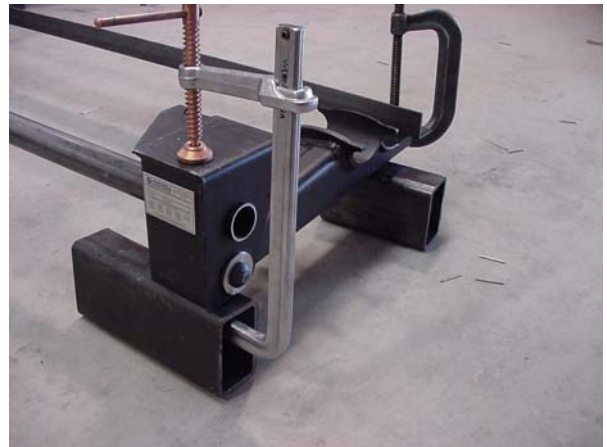

Placing the axle in the beam saddle will help to square and level the beams. Check that outside to outside of hanger is the same as frame width (angle style frames). Align hanger tops by clamping a square to both tops and check with angle finder.



## **Frame Cross Member Requirements**

This suspension requires a cross member above, or in front of, the hangers. If the bottom of the frame is also the trailer floor, the unit needs a 2" angle in front of the hanger at the bottom of the frame. The length of the cross members should equal the frame width. Angles and spacers are customer furnished.



If using an angle in front of the hangers, the angle will need to be ground to allow room for the hanger/frame weld. This needs to be done so the angle can mount firmly against the hanger front for welding. See suspension drawing.



The suspension also requires cross members above the air springs. If the bottom of the frame is also the trailer floor, the unit needs to be spaced down 2" minimum. This is an example of spacing down. The length of these cross members should equal the frame width. Tube and gussets are customer furnished.





## **Hanger & Pipe Fit Up & Welding**

With hanger tops square and frame width set, weld pipe all around to both outside plates of each hanger.



It is easier to precut the pipe to length, 1/2" longer than outside of hangers. Pipe should stick out 1/4" each side for ease of welding.



## **Axle and Beam Fit Up**

Check that spacing at rear of beams is per design:

(Outside of hangers) - (Outside hangers to spring\* centers x 2) = Air spring centers\*

\*Air spring centers can be measured from air spring mounting holes on RH & LH beams



## Axle and Beam Fit Up

For best results, grind or remove paint off axle welding area. This can be done before setting axle in beam seats.



Center the axle in the beam seats. Measure from same points both sides: inside of brake to inside of wing.



If needed, center the axle. Do not hit the brake.



## Axle and Beam Fit Up

Use an angle finder to set the axle drop at 78 degrees (+/- 1 degree) off the bottom of the beams.



The bottom of the beams should be parallel to each other and the “flat surface”. This should happen if the spacer blocks are of equal height. Set the drop at 78 degrees. (This makes the drop vertical when the beam is at ride height.)



Hammer the axle into the beam saddle to minimize saddle gap.

**Note:** Prewired axles will need the wires and grommets to be removed out of axle tube unless hole is at 12 o'clock.





## Axle and Beam Fit Up

C clamp both beams to axle.



Clamps at beam and axle can be removed after the axle has been tacked to saddle. Tack axle at center, typical-2 places each beam saddle.

**CAUTION: Do not “test the arc” on the axle beam.**

**CAUTION: Do not bring axles in from non-heated storage and tack or weld while cold.**

Required axle temp is 70F +/- 20F



## Axle Welding

\*See axle manufacturer's welding notes on electrode spec and grounding. Welds should start from outside of wing and go toward the inside. 1/4" root pass should start 1" in from saddle outside wing tip end, weld out to end, wrap over to inside wing tip end, and wrap back in 1".

(Do not start or stop the weld at the tips of the saddle)



## **Axle Welding**

After each root pass has been done the second 1/4" cover pass should be welded in the same manner as the root weld. Start welding the second pass at the same joint the root welding began, working around the axle in like manner.



After each second pass is done, the third 1/4" cover pass should be welded in the same manner.

**Note:** This axle welding joint requires three 1/4" welds minimum!



### **TYPICAL AXLE WELDING NOTES**

Wire welding recommended.

Welding rods should conform to AWS, Grade E-7018(oven dried) or comparable.

5/32" rods at voltage and amperage recommended by the electrode manufacturer.

For maximum strength, a three-pass weld should be used. The arc should not be broken at the end of each pass, and the corners should be wrapped. The electrode should be backed up to fill in the crater at the end of each pass. Thoroughly clean the weld between each pass.

Electrical grounding to the axle should be done on the beam at the air spring plate or the angle clamped on the beam for square. Grounding should never be done directly on the axle tube or on an area to allow ground to pass through spindle or wheel components.

## Hanger & Axle Placement

For retrofit, locate cross members from center of wheel well. Tack cross members in place, check dimensions. Weld cross members in place.

**Recommended:** Do not weld 1/2" from any loose flange edge. Same method applies when locating cross members for frame fabrication.



For retrofit, place jack under both axle hubs. Move axle under frame cross members. Locate the front hanger along the frame by using the dimension on the Ridewell drawing. Use the dimension from front of hanger to axle(spindle) center when the suspension is at ride height. Add this dimension to 1/2 of your tandem wheel spacing. This gives a dimension from center of wheel well to front of hanger. Place the front of the hangers.



To center the hangers across the frame, measure from hub face to trailer frame side. Once hanger is located, tack in place. Check all dimensions and weld hangers in place.

**Recommended:** Do not weld 1/2" from any edges.





## Hanger & Axle Placement

To locate the second hanger along the trailer, measure both sides from the preset front hanger. These distances should equal the desired axle spacing.



## Air Spring Installation

For ease of installation the air springs can be mounted to the suspension beams before the axle goes on the trailer.

**Note:** See torque specifications.



Once the hangers are mounted to the trailer frame, the upper air spring mounting hardware can be installed.

**Note:** The shock absorber keeps the air spring from over extension. If the shock is not in place do not let the air spring fully extend as damage could occur.

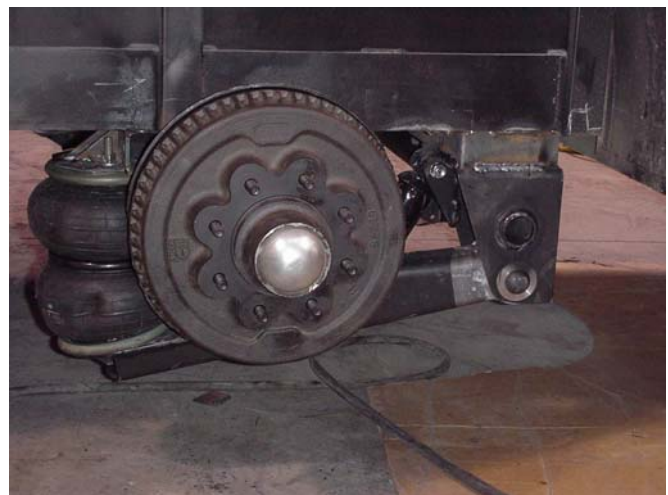



## Axle Alignment

**Note:** Set suspension at “**Ride Height**” or “**Air Spring Design Height**”, shown on suspension drawing. To align the front axle, measure from front of trailer to wheel center both sides. Have the same person read the dimension both sides. This measurement should be +/- 1/16” between RH & LH sides. Locating the hangers properly limits alignment requirements. If alignment is required, the short side can be moved forward up to 3/8”. Use a hammer on the axle to move the beam forward in the hanger slot.



Once the axle is aligned, weld the 2 hanger pivot washers to the hanger, 4 places around.



Set the suspension axles at “**Ride Height**” or “**Air Spring Design Height**”, shown on suspension drawing. Align the second axle to the front axle that is aligned with the pivot washer welded. Measure both sides and check to +/- 1/16”. If alignment is required use the same procedure as the front axle. Once aligned, weld the pivot washers in place.



# Air Control System Installation

## Air Tank

**Note:** If required, modify the provided tank brackets for your application. Mount tank brackets loosely until after the long bolts have been installed. Tank drain must be pointing down.

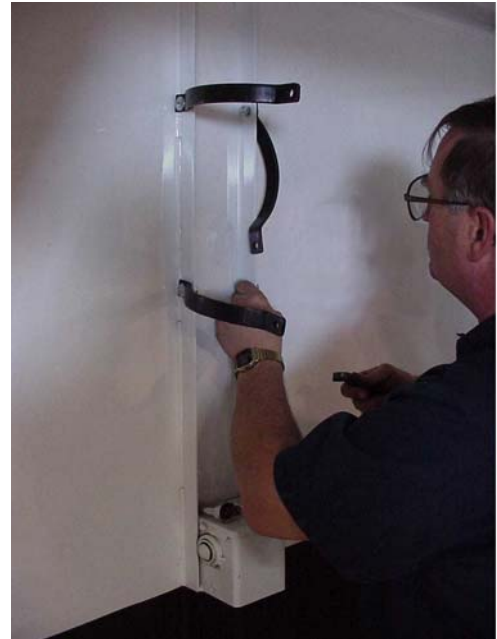

## Air Compressor

Mount the air compressor in a location that is protected from the elements, as shown above, and create a protective shield. Do not totally enclose it in a tight space as this could cause overheating. Inlet air should be relatively dry. The tube from the compressor should be sloping downward toward the tank for proper drainage.

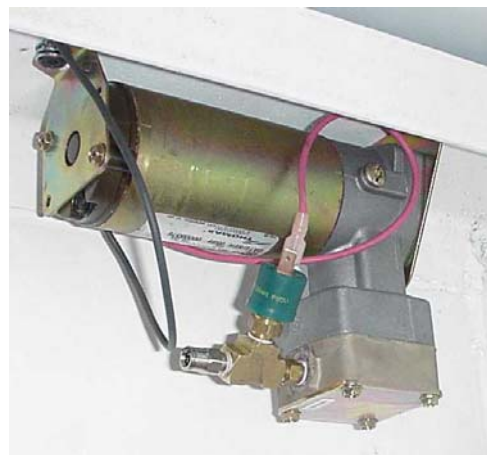

## **HEIGHT CONTROL VALVE**

The Ridewell Lo-Flo Height Control Valve (HCV) is a mechanical device that automatically adds to, or exhausts, air from the air suspension when changes in vehicle load are detected. The valve mounts directly to the suspension so that the valve and linkage are easily and properly located.

### **PRIOR TO INSTALLATION**

- Incorrect installation or adjustment of the HCV may result in poor performance & premature wear, or failure, of the suspension system. Please read all instructions & contact the OEM or Ridewell if any questions arise regarding proper installation.
- Adequate air supply is required for suspension performance.
- For vehicles with air brakes, a pressure protection valve (PPV) must be installed at the reservoir.

### **INSTALLATION & ADJUSTMENT INSTRUCTIONS**

- Prepare the vehicle for installation by parking on a level surface and chocking the wheels to prevent movement.  
**Failure to follow acceptable safety precautions for supporting the weight and preventing vehicle movement could result in serious injury.**
- The suspension/axle system should be blocked to the desired ride height (center of axle to bottom of frame). Consult the suspension or vehicle OEM for the proper suspension ride height.
- Determine the correct orientation of the lever to the drive cap. The alignment notch on the drive bearing cap should be used to properly locate the drive cap with the lever placed in the cap slot - be sure the lever rotates up to fill ("FILL") and down to exhaust ("EXH") as noted on the HCV body. Assemble the lever to the drive mechanism with the 1/4" tapping screw. Torque to 50-55 in-lbs.
- Install the HCV on the suspension as shown on page 16. Place two (2) t-bolts into the mounting slots and mount the HCV to the vehicle frame or mounting bracket. Torque the 1/4-20 nuts to 60-80 in-lbs.
- Assemble the vertical linkage to the HCV and lower mounting bracket as shown. The vertical link is adjustable at the lower end – any excess rod length should be cut off. Torque 1/4" and 5/16" fasteners to 60-80 and 90-120 in-lbs respectively.
- The HCV should be in the center position prior to tightening the lower linkage connection (band clamp on "P" connector).
- Install air lines to the correct HCV ports, ensuring that air lines do not chafe on the other components. 90 degree PTC elbows that install in the HCV ports are available from Ridewell, if necessary, to redirect air lines.
- Air up the vehicle and check for leaks. **Leaks will cause premature wear on the compressor.**
- Safely remove the mounting height blocks.
- Check for proper function of the HCV. Raise the suspension by manually rotating the lever 20 to 30 degrees in the "FILL" direction. Upon release of the lever, the HCV should exhaust and the suspension should return to its pre-set mounting height. Rotate the lever toward the "EXH" position 20 to 30 degrees. The suspension should return to the pre-set mounting height as the HCV adds air to the air springs. If this operation is backwards, the drive bearing cap will need to rotate 180 degrees and the lever re-positioned.
- Small adjustments may be necessary to achieve exact ride height by adjusting the "P" connector to the vertical link.  
**Setting the suspension to the correct ride height is critical to proper suspension function.**
- **MAINTENANCE** • Routinely inspect for proper mounting height and re-adjust if necessary. • Inspect for air leaks
  - Inspect for loose connections and re-torque fasteners as necessary. • Inspect for chafed air lines.

## HEIGHT CONTROL VALVE SCHEMATIC

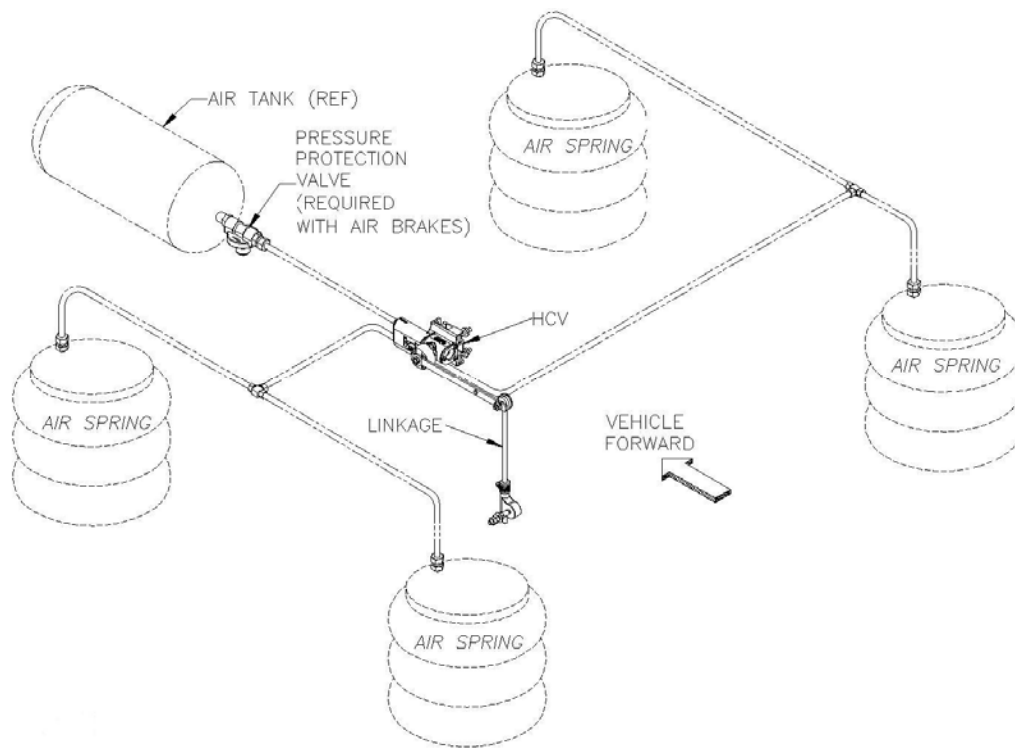

### RAR-244 8K Underslung

#### Symbol Identification

- 1 = Height Control Valve
- 2 = Lever
- 3 = Upper Pin Assembly
- 4 = Vertical Link
- 5 = "P" Connector
- 6 = Clamp
- 7 = Lower Pin Assembly
- 8 = Upper Bracket

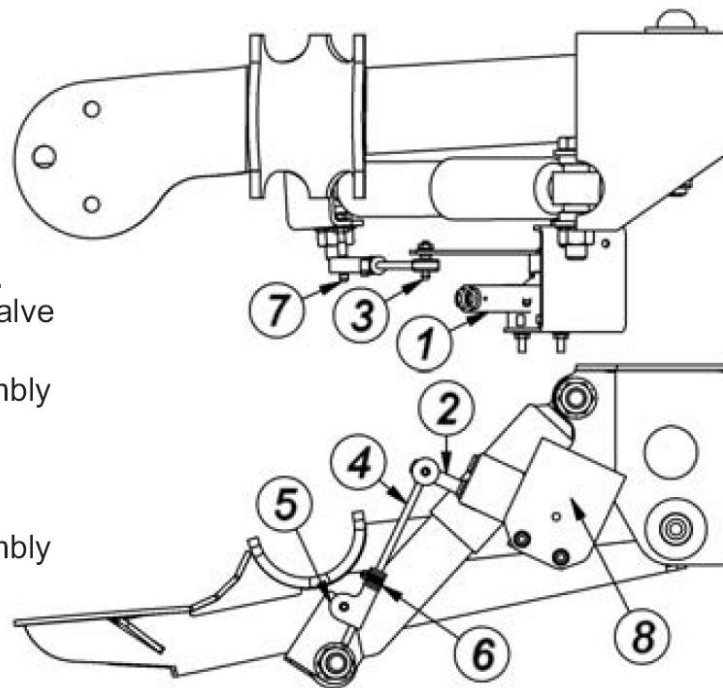



# Quality Inspection

## Welds / Pivot Washers

Inspect all welds and hanger to frame connection. The suspension pivot washers **must be welded** or failure can occur. Visually inspect the Huck bolt.

Inspect for proper installation of pipe cross member.

Inspect all welds at the axle and beam saddle.



## Tire Clearances

On new installation applications:

Inspect inside of tire and frame clearance. All tire clearances should be 1" minimum



## Wheel Alignment

Inspect axle alignment per guidelines on page 13.



Inspect that tires are centered in wheel well when at "**Ride Height**".

Inspect articulation clearances: jack up both axles, one at a time.

## HCV Air Lines & Air Springs

Inspect Height Control Valve for proper installation. Valve should be mounted so linkage is free to operate without interference. Check all linkage connections and air fittings on valve for tightness. Check all fittings for air leaks with soapy water. Check that all air springs have a minimum of 1" clearance when inflated.



## Ride Height

Inspect the suspension ride height per drawing. If incorrect, adjust the HCV linkage until proper ride height is achieved.

# Preventive Maintenance

## Daily

Visually inspect trailer to be sure it is level and that suspension “**Ride Height**” is correct. Check for loose or broken parts on or around suspension to prevent any serious problems from occurring.

## Every 30 Days

Check clearances around all moving suspension parts, air springs, ties and shock absorbers. Any signs of interference should be immediately corrected.

Visually inspect axle connection weld and bolt connections to make sure they are secure. Review and correct any signs of wear.

## Every 90 Days & With Annual Inspection

Check items mentioned above in **DAILY & 30 DAY** inspections.

Also, inspect weld integrity at the following connections: Suspension-to-axle, pivot washer, and hanger-to-frame.

All pivot and clamping connections such as the suspension pivot and the shock mounting must be inspected.

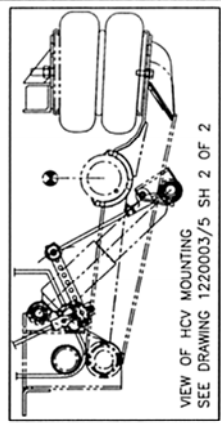
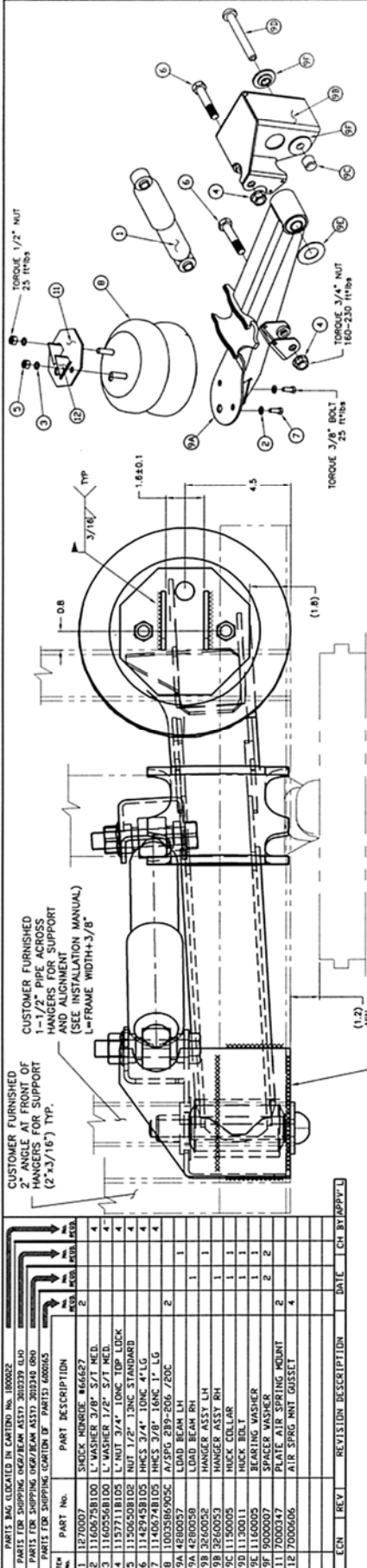

TIRE TYPE	TIRE MAX CAP.	AXLE RIDE HT	GROUND RIDE HT	FRAME RADIUS	AXLE RADIUS	FREE RADIUS
12-16-SLT	4025875	2	16.9	13.8	14.9	13.8
9-20-16-SLT	2370275	2	16.2	13.4	14.2	13.4
9-20-14-SLT	32304100	2	15.3	12.2	13.3	14.2
235-85R-16	37508110	2	16.3	13.4	14.3	15.4
215-75R-17.5	48058125	2	16.3	13.3	14.3	15.3

MAX SPEED #5500PH

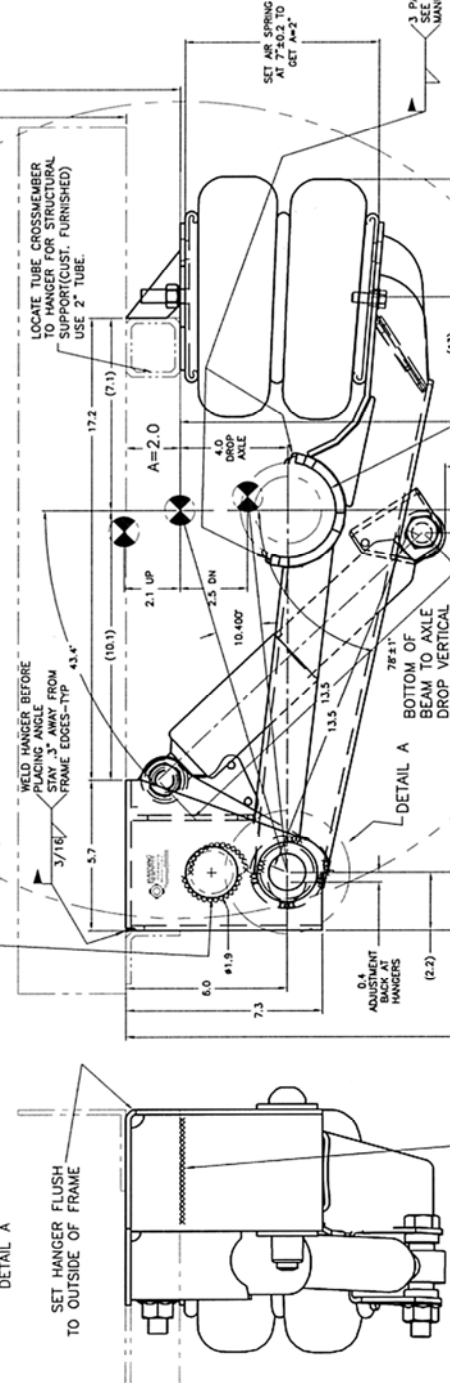
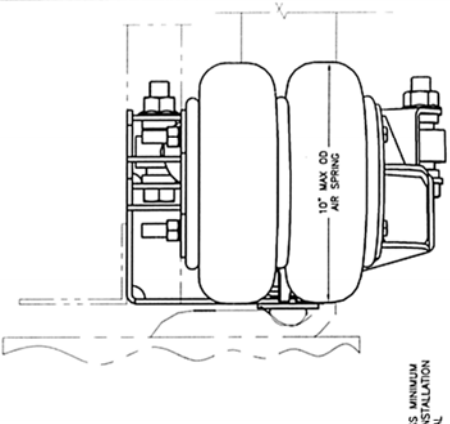

MAX CAPACITY = 8000 lbs

DATE	12/27/03	BY	DL
DESIGNED	DL	DRAWN	DL
CHECKED	DL	APP. BY	DL

1220003/5 SH 2 OF 2

2440003

# Featheride™

## Parts Explosion

PARTS BAG (LOCATED IN CARTON) No. 1800022						
PARTS FOR SHIPPING (HGR/BEAM ASSY) 3010339 (LH)						
PARTS FOR SHIPPING (HGR/BEAM ASSY) 3010340 (RH)						
PARTS FOR SHIPPING (CARTON OF PARTS) 6000165						
ITEM No.	PART No.	PART DESCRIPTION	No. REQD.	No. REQD.	No. REQD.	No. REQD.
1	1270007	SHOCK MONROE #66627	2			
2	1160675B100	L' WASHER 3/8" S/T MED.				4
3	1160556B100	L' WASHER 1/2" S/T MED.				4
4	1157711B105	L' NUT 3/4" 10NC TOP LOCK				4
5	1150650B102	NUT 1/2" 13NC STANDARD				4
6	1142945B105	HHCS 3/4" 10NC 4" LG				4
7	1140674B105	HHCS 3/8" 16NC 1" LG				4
8	1003586905C	A/SPG 2B9-206 /20C	2			
9A	4280057	LOAD BEAM LH			1	
9A	4280058	LOAD BEAM RH		1		
9B	3260052	HANGER ASSY LH			1	
9B	3260053	HANGER ASSY RH		1		
9C	1150005	HUCK COLLAR		1	1	
9D	1130011	HUCK BOLT		1	1	
9E	1160005	BEARING WASHER		1	1	
9F	9000007	SPACER WASHER		2	2	
11	7000347	PLATE AIR SPRING MOUNT	2			
12	7000606	AIR SPRG MNT GUSSET	4			

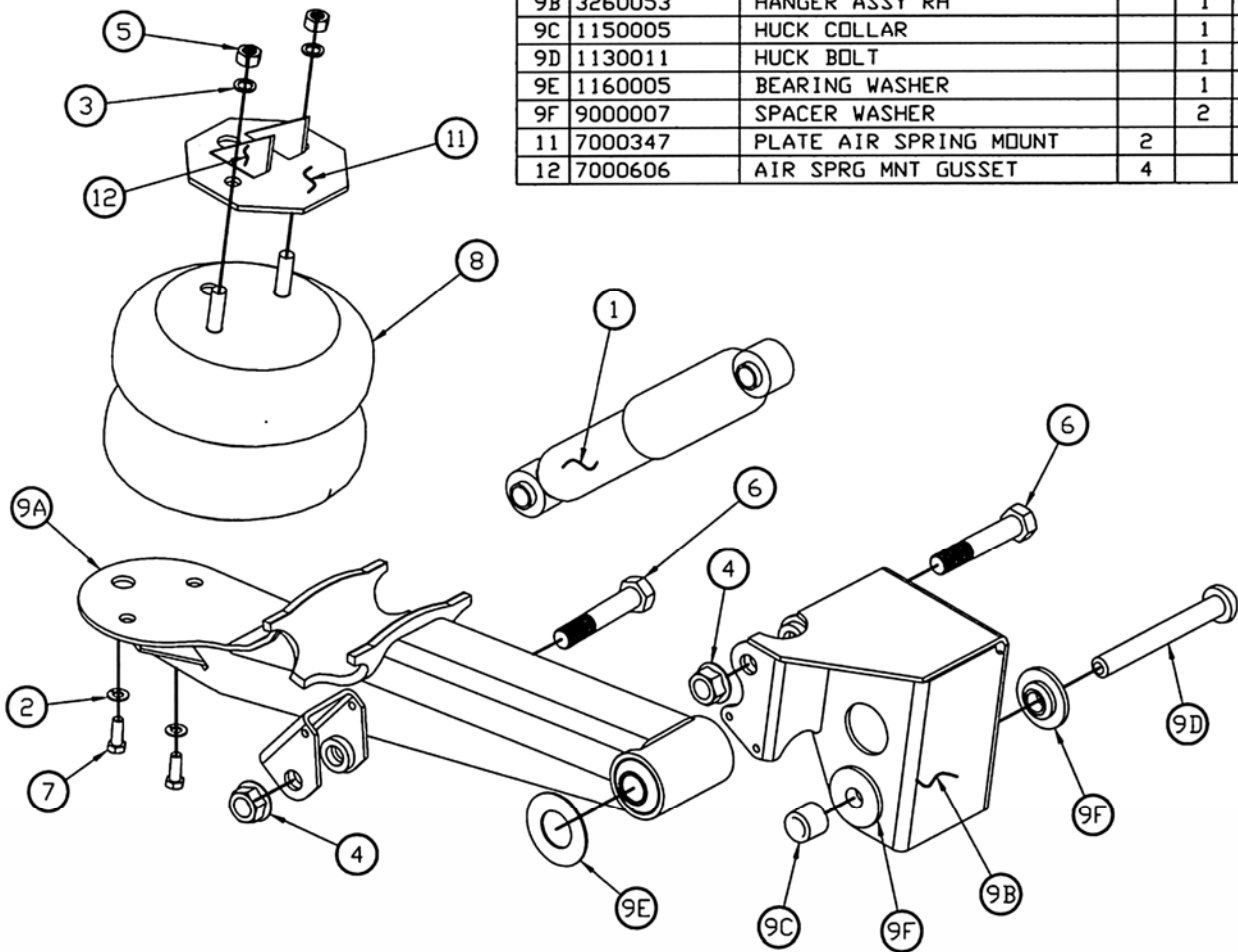



ITEM 33 RELAY ENLARGED FOR CLARITY

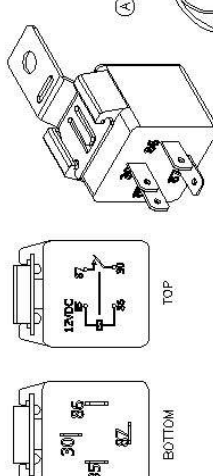

WIRE DESIGNATION	
A	10 GA, 2 FT LONG, ORANGE RELAY #30 TO RED MOTOR WIRE
B	10 GA, 2 FT LONG, RED POWER
C	14 GA, 2 FT LONG, RED TO POWER
D	14 GA, 2 FT LONG, BLACK RELAY #86 TO GROUND
E	14 GA, 2 FT LONG, BLUE RELAY #85 TO PRESSURE SWITCH

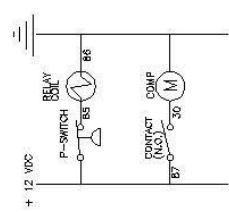

NO	PART NO.	PART DESCRIPTION	QTY	UNIT
1	1141191B105	CAP 250VDC, 5/8x16 HE X 1.1/2" LS	4	EA
2	11630018102	NUT, 3/8-16 N.C.	4	EA
3	11600759100	LOCK WASHER, 3/8" IND.	4	EA
4	12345678901	COMPRESSOR TANK 50/200GAL/5"	1	EA
5	12345678901	AIR TANK	1	EA
6	12345678901	WTC BRKT KIT FOR 3" AIR TANK	1	EA
7	12345678901	DRAIN OBSC, 1/4" NPT	1	EA
8	12345678901	WIRE ASSEMBLY, 70 AMP	1	EA
9	12345678901	ELBOW, 1/4 NPT X 1/4 PTC	1	EA
10	12345678901	CONV. W/LE, 1/4 NPT X 1/4 TUBE	1	EA
11	12345678901	FLAT WASHER, 1/4"	1	EA
12	12345678901	FLAT WASHER, 1/4"	1	EA
13	12345678901	10 GA WIRE, RED, 15 FT, 50A, 10-2	1	EA
14	12345678901	1/4" PLASTIC TUBE, 40 FT, L6	1	EA
15	12345678901	KEY KIT	1	EA
16	12345678901	1/4" NPT X 1/4 TUBE	1	EA
17	12345678901	1/4" NPT X 1/4 TUBE	1	EA
18	12345678901	1/4" NPT X 1/4 TUBE	1	EA
19	12345678901	1/4" NPT X 1/4 TUBE	1	EA
20	12345678901	1/4" NPT X 1/4 TUBE	1	EA
21	12345678901	1/4" NPT X 1/4 TUBE	1	EA
22	12345678901	1/4" NPT X 1/4 TUBE	1	EA
23	12345678901	1/4" NPT X 1/4 TUBE	1	EA
24	12345678901	1/4" NPT X 1/4 TUBE	1	EA
25	12345678901	1/4" NPT X 1/4 TUBE	1	EA
26	12345678901	1/4" NPT X 1/4 TUBE	1	EA
27	12345678901	1/4" NPT X 1/4 TUBE	1	EA
28	12345678901	1/4" NPT X 1/4 TUBE	1	EA
29	12345678901	1/4" NPT X 1/4 TUBE	1	EA
30	12345678901	1/4" NPT X 1/4 TUBE	1	EA
31	12345678901	1/4" NPT X 1/4 TUBE	1	EA
32	12345678901	1/4" NPT X 1/4 TUBE	1	EA
33	12345678901	1/4" NPT X 1/4 TUBE	1	EA
34	12345678901	1/4" NPT X 1/4 TUBE	1	EA

NOTES:  
 1. 10 GA STRANDED COPPER AUTOMOTIVE CABLE IS REQUIRED. CABLE RUNS OVER 50 FT. MAY REQUIRE 8 GA. IN ORDER TO AVOID VOLTAGE DROP AND POWER LOSS.  
 2. COMPRESSOR MOTOR MUST BE PROPERLY GROUND TO OPERATE.  
 3. PIPE SEALER OR TETON THREAD TAPE MUST BE USED ON PIPE THREADS. TIGHTEN NPT FITTINGS 10-12 FT/LB.  
 4. AFTER UNIT IS COMPLETELY INSTALLED AND PRESSURIZED, CHECK ALL CONNECTIONS WITH A SOAPY WATER SOLUTION FOR LEAKS.  
 5. THIS DRAWING SHOWS A TYPICAL INSTALLATION. COMPRESSOR AND AIR TANK MUST BE MOUNTED WITH DRAIN COCK DOWN.  
 6. PRESSURE SWITCH ON AIR COMPRESSOR ASSEMBLY IS SET TO TURN ON AT 80 P.S.I. AND OFF AT 100 P.S.I.  
 7. AFTER INSTALLATION IS COMPLETE AND IN SERVICE, WATER MUST BE DRAINED FROM AIR TANK ON A REGULAR BASIS.  
 8. AIR FILTER IS PART OF AIR COMPRESSOR ASSY. FILTER ELEMENT MUST BE CHANGED A MINIMUM OF ONCE PER YEAR. NECESSARY PARTS MUST BE ORDERED IN ADVANCE. CHANGES ARE NECESSARY WHEN OPERATED IN DUSTY ENVIRONMENT.  
 9. INSTALL THE HOV AS PER THE INSTRUCTIONS IN HOV KIT. CUT OFF EXCESS LENGTH ON THE VERTICAL LINK AFTER INSTALLATION IS COMPLETE AND SUSPENSION MAINTAINS PROPER RIDE POSITION.  
 10. ELECTRIC GREASE RECOMMENDED ON TERMINALS.  
 11. A SCREWDRIVER IS REQUIRED TO REMOVE RELAY FROM BASE. DISCONNECT POWER BEFORE REMOVING RELAY.  
 12. ALL CONNECTIONS MUST BE AIR TIGHT FOR PROPER PERFORMANCE.

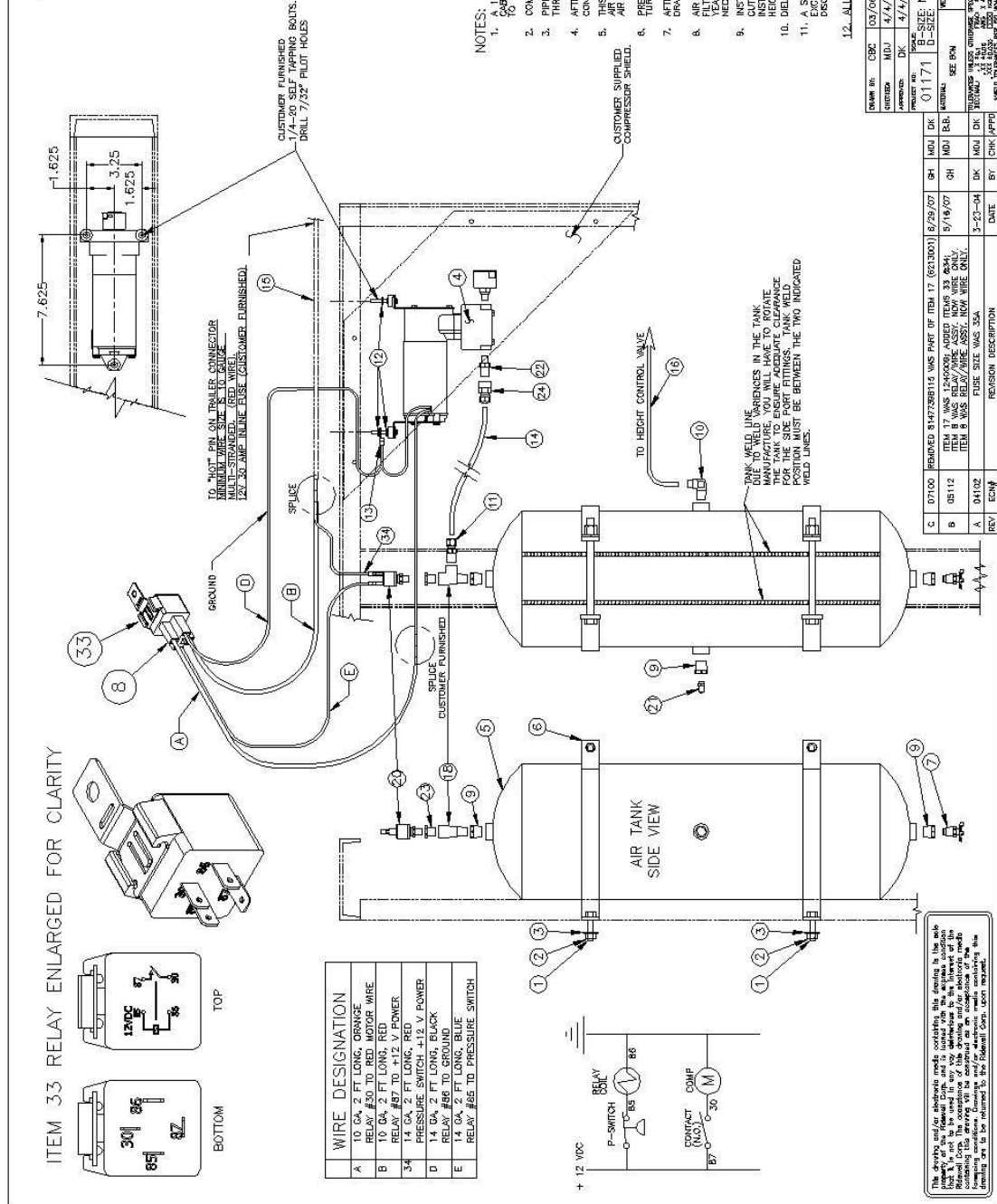

REV	DATE	BY	CHK	DESCRIPTION
C	01/17/02	JK	JK	ISSUE 01/17/02
B	05/12/02	JK	JK	ISSUE 05/12/02
A	04/10/02	JK	JK	ISSUE 04/10/02

**RIDEWELL CORPORATION**  
 P.O. BOX 4596, SPRINGFIELD, MISSOURI 65908  
 TITLE: ACK/AIR COMPRESSOR - TANK ASSY. W/PRESS SWITCH-LO FLO VALVE, ASSOCIATED FITTINGS  
 PART NO: 1220003/5  
 SHEET 1 OF 2  
 REV: C



# NOTES