

2007 LCD Models – North America
TLA-04011C, TLXB-4011, TLXB-4241



SERVICE MANUAL



Bezel covers vary by model
20070613

Important Service and Safety Information



WARNING



CAUTION

Prior to using this service manual, please ensure that you have carefully followed all the procedures outlined in the user's manual for this product.

- (1) Read all of these instructions.
- (2) Save these instructions.
- (3) Follow all warnings and instructions marked on the product.
- (4) Unplug this product from the wall outlet before cleaning. Do not use liquid cleaners or aerosol cleaners; use a damp cloth for cleaning.
- (5) Do not use this product near water.
- (6) Do not place this product on an unstable cart, stand or table. The product may fall, causing serious damage to the product.
- (7) Slots and openings in the cabinet and the back or bottom are provided for ventilation, to ensure reliable operation of the product and to protect it from overheating, those openings must not be blocked or covered. The openings should never be blocked by placing the product on a bed, sofa, rug, or other similar surface. This product should not be placed in a built-in installation unless proper ventilation is provided.
- (8) This product should be operated from the type of power source indicated on the marketing label. If you are not sure of the type of power available, consult your dealer or local power company.
- (9) This product is equipped with a 3-wire grounding type plug, a plug having a third (grounding) pin. This plug will only fit into a grounding-type power outlet. This is a safety feature, if you are unable to insert the plug into the outlet, contact your electrician to replace your obsolete outlet. Do not ignore the purpose of the grounding-type plug.
- (10) Do not allow anything to rest on the power cord. Do not locate this product where people will walk on the cord.
- (11) If an extension cord is used with this product, make sure that the total of the ampere ratings on the product plugged into the extension cord does not exceed 15 ampere.
- (12) Never push objects of any kind into this product through cabinet slots as they may touch dangerous voltage points or short out parts that could result in a risk of fire or electric shock. Never spill liquid of any kind on the product.
- (13) Do not attempt to service this product yourself, as opening or removing covers may expose you to dangerous voltage points or other risks. Refer all servicing to service personnel.
- (14) Unplug this product from the wall outlet and refer servicing to qualified service personnel under the following conditions:
 - a. When the power cord or plug is damaged or frayed.
 - b. If liquid has been spilled into the product.
 - c. If the product has been exposed to rain or water.
 - d. If the product does not operate normally, when the operating instructions are followed. Adjust only those controls that are covered by the operating instructions since improper adjustment of other controls may result in damage and will often require extensive work by a qualified technician to restore the product to normal operation.
 - e. If the product has been dropped or the cabinet has been damaged.
 - f. If the product exhibits a distinct change in performance, indicating a need for service.

Important Service and Safety Information

Service work should be performed only by qualified service technicians familiar with all safety checks and these service guidelines:

ELECTRIC SHOCK HAZARD



WARNING

Always disconnect AC power before servicing!
Never modify any circuit!
Never insert any objects into the holes in the TV case!

ELECTROSTATIC DISCHARGE (ESD)

Components inside an LCD or plasma TV are sensitive to static electricity. Before servicing the TV, follow these guidelines:

- Avoid static-causing surfaces such as carpeted floors, plastic, and packing foam.
- Remove replacement components from their antistatic bags only when you are ready to use them. Do not lay components on the outside of antistatic bags because only the inside of the bags provide electrostatic protection.
- Always hold components by their edges. Avoid touching the edge connectors. Never slide components over any surface.
- Wear a grounding wrist strap (available at most electronics stores) and attach it to a bare metal part of your workbench or other grounded connection.
- Touch a bare metal surface on your workbench or other grounded object before touching any components.

NOTICE ABOUT REPLACEMENT PARTS



CAUTION

Many electrical and mechanical parts within LCD or plasma televisions are chosen for their specific safety characteristics within the overall system. Replacing individual parts with components rated for higher voltage or wattage can be dangerous!

Replacement parts must always be identical to those originally used in the television. Unauthorized substitute parts may result in fire, electric shock, or other hazards.

Important Service and Safety Information

PRECAUTIONS FOR USING LEAD-FREE SOLDER

Components within this television use lead-free solder (Sn-Ag-Cu). Whenever soldering, look at the markings on boards and components within the television to determine the correct solder type according to the table below.

5 LEAD-FREE (Pb-Free) CATEGORIES

The following categories are meant to describe the Pb-free 2nd level interconnect terminal finish, component material, and/or the solder paste/solder used in board assembly:

- e1 - SnAgCu (shall not be included in category e2)
- e2 - Sn alloys with no Bi or Zn excluding SnAgCu
- e3 - Sn
- e4 - Precious metal (e.g., Ag, Au, NiPd, NiPdAu) (no Sn)
- e5 - SnZn, SnZnx (no Bi)
- e6 - contains Bi
- e7 - low temperature solder (≤ 150 °C) containing Indium (no Bi)
- e0, e8, e9 symbols are unassigned at this time.

When repairing components soldered with lead-free solder, ONLY use lead-free solder that matches the symbol on the component. Using conventional lead solder may lead to damage or a short, which could result in fire, electric shock, or other hazards.

Because the melting point of lead-free solder is higher than conventional lead solder, observe the following guidelines when soldering with lead-free solder:

- (1) Always use a dedicated soldering bit for different types of solder. If a different type of solder comes in contact with a lead-free solder bit, subsequent solder joints will no longer be lead free. Always clean the soldering bit after every use.
- (2) Keep the soldering bit in contact with the just long enough to confirm a good solder joint. Leaving the bit in contact with parts for an extended period may damage the components.
- (3) Because lead-free solder contains a higher concentration of tin, the tip of the soldering bit may be easily corroded or damaged. Do not leave the bit powered on for extended periods. When the tip of the soldering bit is blackened during use, clean the bit with steel wool or fine sandpaper.

Table of Contents

1.	Specifications.....	6
2.	Operation	10
3.	Troubleshooting / Flow Charts	16
	Factory Mode Procedure.....	16
4.	Polaroid Display Cell Defect Specification.....	20
5.	Before Returning This Product to the User.....	21
6.	Disassembly Procedure.....	22
	Stand and Control Box Removal.....	23
	Rear Cabinet Cover, LCD Panel and Front Bezel	25
	IR Board Removal and Replacement	32
	Front/Side Control Buttons Removal and Replacement	33
7.	Spare Parts Lists	34
8.	Exploded View Diagram.....	36
9.	Block Diagram	37
10.	Schematics	38
11.	PCB Layout Diagrams	47

Model Specifications are located in User Manual. Go to polaroid.com to obtain User Manual.

1. Specifications

TLA-04011C, TLXB-4011

Item	Specifications
Panel Name	SAMSUNG
Display pixels	1366 (H) x 768 (V) pixels (1 pixel = 1 RGB cells)
Display Area	34.85 in (H) x 19.59 in (V) 885.168mm (H) x 497.664mm (V)
Display Colors	16.7M
Pixel Arrangement	R+G+B vertical stripe
Brightness	500 nits typical
Contrast Ratio	1200:1 typical
Viewing Angle	±89° (H), ±89°(V) Typical at CR ≥ 10
Color Chromaticity (CIE)	White: x= 0.280 , y =0. 290
Response Time	8ms (Gray to Gray)
Surface Treatment	Haze 40% , Hard-Coating (3H)

TLXB-4241

Item	Specifications
Panel Model No.	V420H1-L05
Display pixels	1920 (H) x 1080 (V) pixels (1 pixel = 1 RGB cell)
Display Area	36.6 in (H) x 20.6 in (V) 930.24mm (H) x 523.26mm (V)
Pixel Pitch	0.1615 (H) x 0.4845 (V)
Display Colors	16.7M
Pixel Arrangement	R+G+B vertical stripe
Brightness	500cd/m ² typical
Contrast Ratio	1200:1 typical at CR ≥ 10
Viewing Angle	176 (H)/ 176(V) Typical
Color Chromaticity (CIE)	White: X = 0.285 , Y = 0.293 Typical
Response Time	6ms (Gray to Gray)
Surface Treatment	Hard-Coating (3H), Anti-Glare coating (Haze 25%)

INPUT Source :

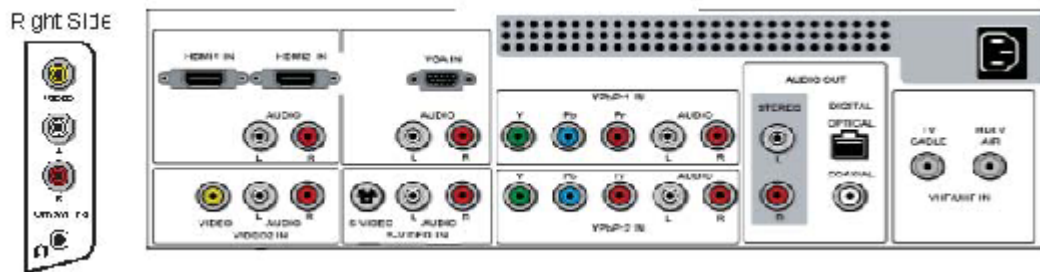

Inputs & Outputs	Signals	Video Format	Connector types	
				OSD
TV	Analog TV	NTSC	F Type	TV (CABLE/AIR)
HDTV	Digital TV	8VSB	F Type	HDTV (CABLE/AIR)
VIDEO1	Video + L/R Audio + Earphone Out	CVBS	RCA	VIDEO1 (SIDE)
VIDEO2	Video + L/R Audio	CVBS	RCA	VIDEO2 (REAR)
S-VIDEO	S-VIDEO+ L/R Audio	Y/C	Mini Din 4 Pin	VIDEO3 (S-VIDEO)
YPbPr1	Component (Y, Pb/Cb, Pr/Cr) + L/RAudio	480i, 480p, 720p, 1080i	RCA	VIDEO4 (YPbPr1)
YPbPr2	Component (Y, Pb/Cb, Pr/Cr) + L/RAudio	480i, 480p, 720p, 1080i	RCA	VIDEO5 (YPbPr2)
HDMI1	HDMI	Digital RGB + Digital Audio	HDMI 19 Pin	VIDEO6 (HDMI1)
HDMI2	HDMI	Digital RGB + Digital Audio	HDMI 19 Pin	VIDEO7 (HDMI2)
VGA	VGA+ L/REarphone	Analog RGB	D-SUB 15 Pin	COMPUTER (VGA)
AUDIO OUT	L/R Audio		RCA	STEREO
	Digital Optical/COAXIAL		TOSLINK/RCA	DIGITAL
AC IN	AC Power IN	AC 100~240V	YC14	AC IN

HDMI				
Format	DVI 1.0			
Level/Impedance	0.5~3.0Vp-p/100 Ohm (Differential),50 Ohm (Single ending)			
TMDS Mode	Single Link			
Frequency	Fh = 31~60 kHz Fv = 56~76 Hz			
Maximum Pixel Clock	135 MHz			
DDC 1/2B	Compliant with Revision 1.0			
Connector	HDMI x 1			
Analog HD15 PC Signal (RGB)				
Format	R, G, B Analog			
Level/Impedance	0.7Vp-p / 75 Ω			
DDC 1/2B	Compliant with Revision 1.0			
Sync	H/V separate 3VTTL level / 1k Ω			
Frequency	Fh = 31~60 kHz Fv = 56~76 Hz			
Maximum Pixel Clock	135 Mhz			
Connector	Mini D-Sub 15 pin (female) x 1			
Video (Composite) CVBS Signal				
Format	NTSC, 4.43NTSC, PAL_M, PAL(B,G,H,D,N), SECAM			
Level / Impedance	1.0Vp-p / 75 Ω			
S-Video (Y/C) Signal				
Format	Y, C			
Level / Impedance	Y: 1.0Vp-p / 75 Ω C: \pm 286 mV / 75 Ω			
Analog HD15 Video Signal (YPbPr/YCbCr)				
Format	Y, Pb, Pr or Y, Cb, Cr			
Level / Impedance	Y: 1.0Vp-p / 75 Ω Pb/Cb, Pr/Cr: 0.7 \pm 0.035Vp-p / 75 Ω			
HDMI Timing				
STANDARD	RESOLUTION	V FREQ Hz	H FREQ kHz	CLK MHz
ATSC, 480i	720x480	60	15.7	27
ATSC, 480p	720x480	60	31.5	27
ATSC, 1080i	1920x1080	60	33.7	74.2
ATSC, 720p	1280x720	60	45.0	74.2
ATSC, 576i	720x576	50	15.6	27

RGB PC Timing				
STANDARD	RESOLUTION	V FREQ Hz	H FREQ kHz	CLK MHz
VGA	640x480	60	31.47	25.16
VGA	640x480	75	37.5	31.5
SVGA	800x600	60	37.88	40
SVGA	800x600	75	46.9	49.5
XGA	1024x768	60	48.36	65.0
XGA	1024x768	75	60.02	78.75
SXGA	1280x1024	60	64	108
SXGA	1280x1024	75	80	135
MAC	640x480	67	35	30.24
Non-VESA	720x400	70	31.5	28
Video & S-Video AV Timing				
STANDARD	RESOLUTION	V FREQ Hz	H FREQ kHz	CLK MHz
NTSC	525	60	15.734	12.65
PAL(B,G,H,D,I)	625	50	15.625	14.50
SECAM	625	50	15.625	14.50
4.43NTSC	525	60	15.734	12.65
PAL-M	525	60	15.734	12.65
PAL-N	625	50	15.625	14.50
HDTV/Component AV Timing				
SDTV 525i	720x525	60	15.735	27
SDTV 625i	720x625	50	15.625	27
SDTV 480p	720x480	60	31.5	27
HDTV 720p	1280x720	60	50.0	74.2
HDTV 1080i	1920x1080	60	33.7	74.2
Power Source	AC100 – 240 V, 60/50 Hz			
Sound Output	10W X2, 8 Ohm.			

2. Operation

Front/Right Side View and Controls

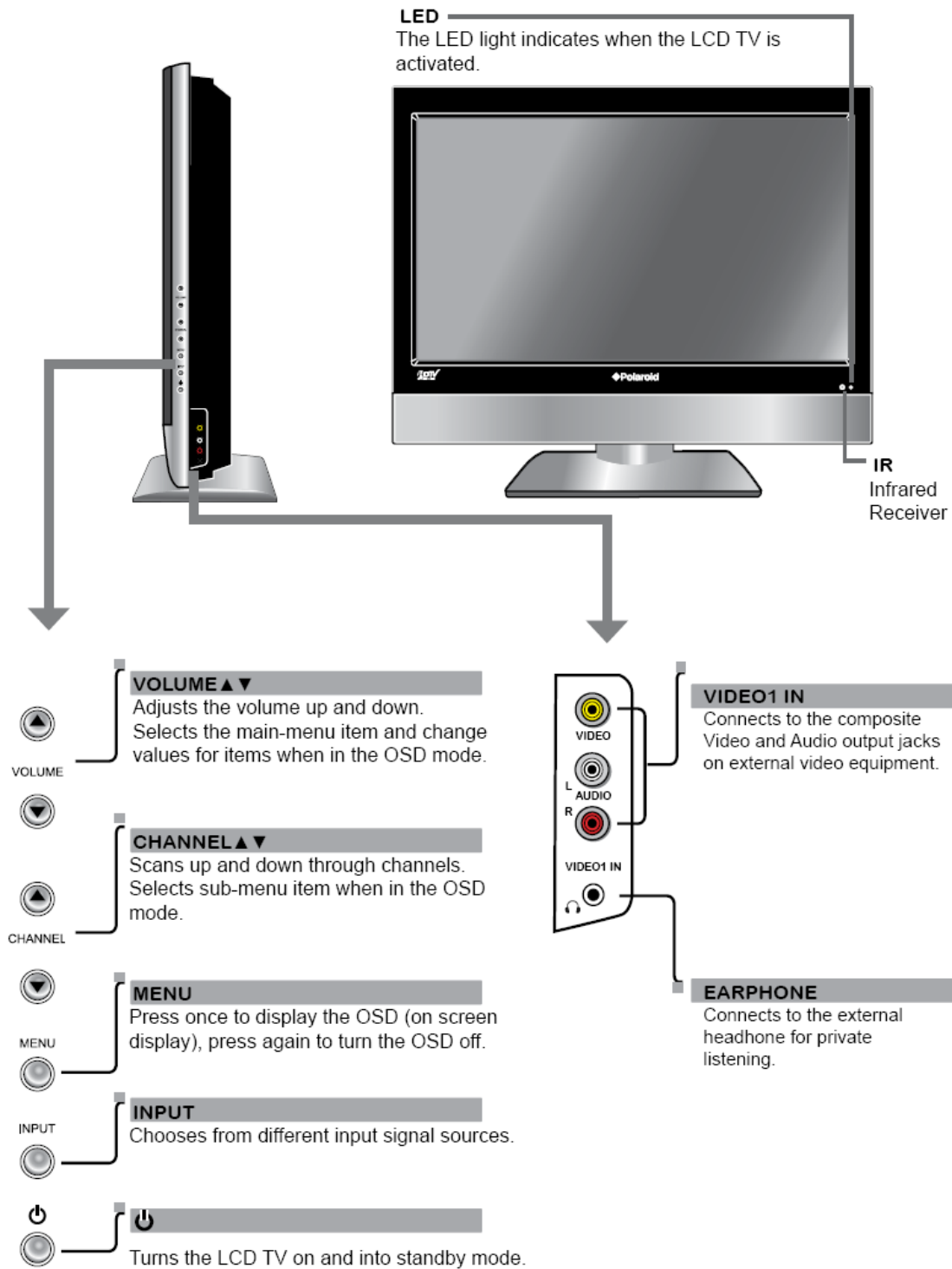

Rear View and Jacks

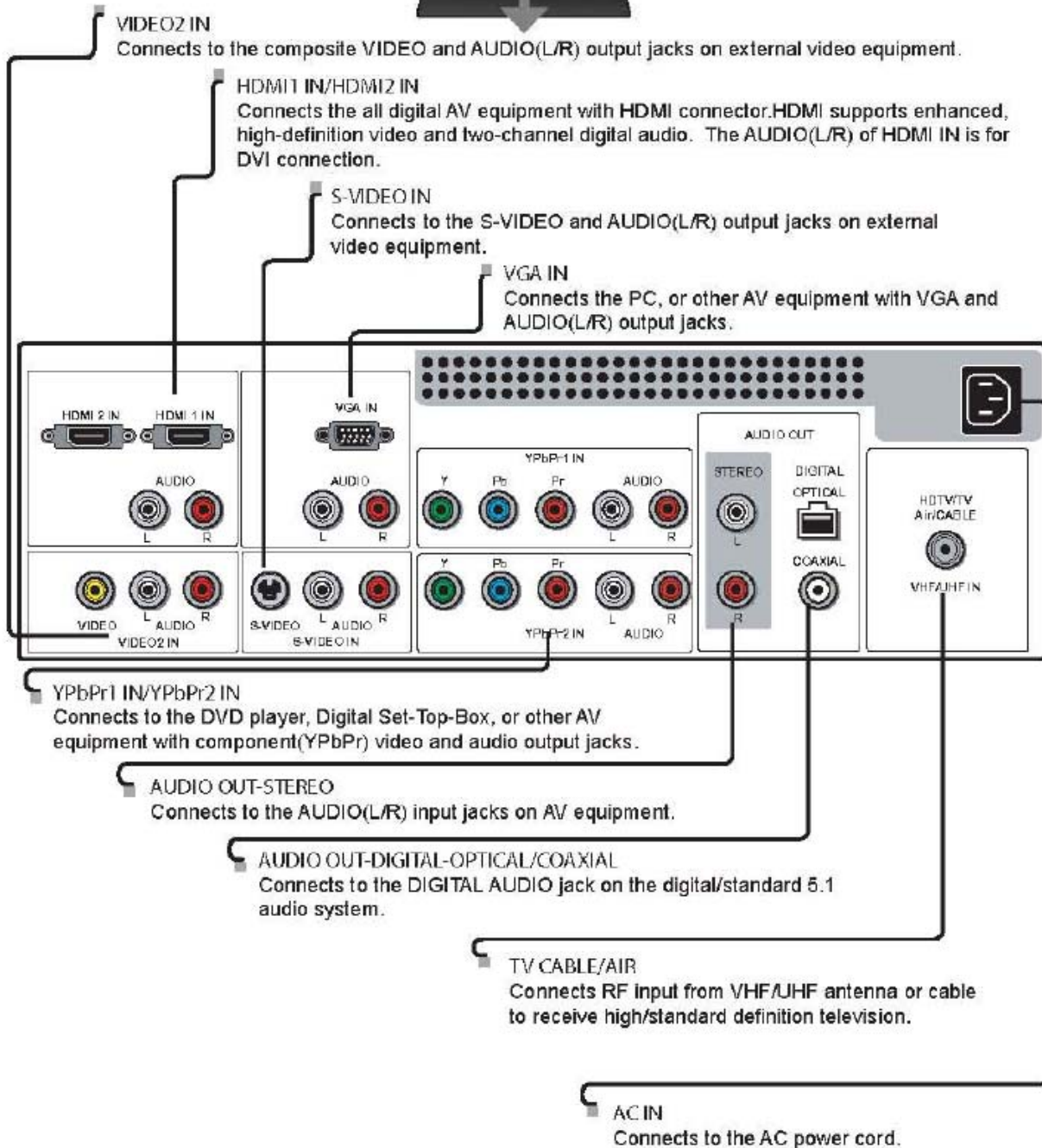

Remote Control

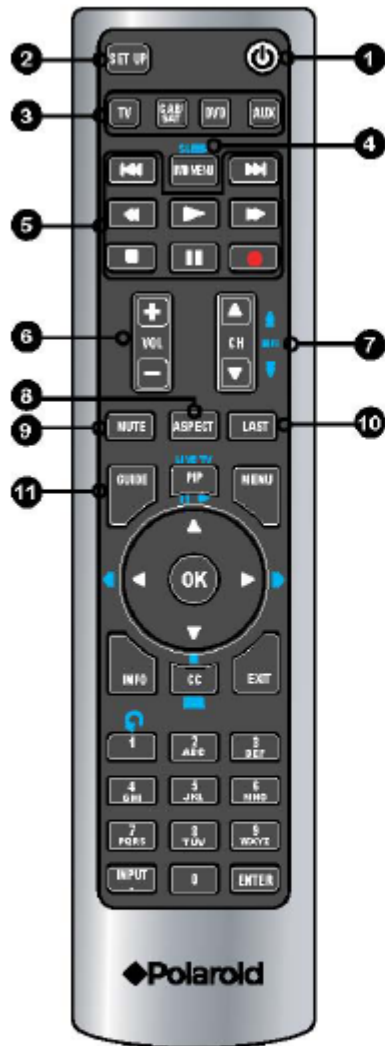

- 1**  Turns the LCD TV on and off

- 2** **SET UP** Remote control universal code setup. For more information on setting up your remote control, please see the "Programming Your Remote Control" section (refer to page 47)

- 3** **TV** Controls this LCD TV
- CAB/SAT** Controls Cable Converter or Satellite Receiver
- DVD** Controls DVD player or Video player
- AUX** Controls Audio Amplifier

- 4** **SLEEP** Cycles through the LCD TV sleep time: OFF/30/60/90/120 mins

- 5**  Other device function keys

- 6** **VOL+/-** Increases and decreases volume

- 7** **CH▲▼** Change channel up and down

- 8** **ASPECT** Cycles through Wide mode settings: NORMAL/FULL/WIDE/ZOOM

- 9** **MUTE** Pressing once mutes audio. Pressing again restores audio

- 10** **LAST** Returns to previously selected channel

- 11** **GUIDE** In TV mode, pressing GUIDE displays the Program Guide on the screen

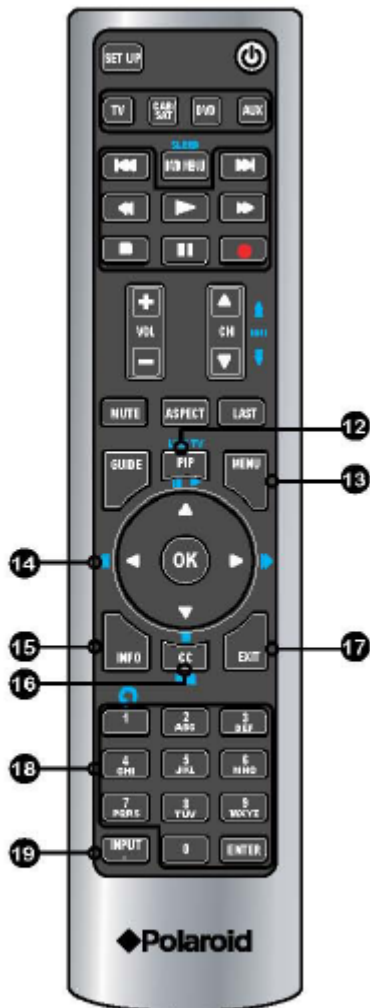

- | | | |
|-----------|------------------|---|
| 12 | PIP | Turns PIP/POP on and off |
| <hr/> | | |
| 13 | MENU | Displays the OSD menu on the screen. |
| <hr/> | | |
| 14 | ◀▶▲▼,OK | Cycles through OSD options and selects individual menu items. OK confirms option settings |
| | OK | In TV mode, pressing OK to display a channel list |
| <hr/> | | |
| 15 | INFO | Displays information on the LCD TV screen such as input source, channel, program title. |
| <hr/> | | |
| 16 | CC | Cycles through the Closed Caption:
<ul style="list-style-type: none"> ▪ Analog Closed Caption: OFF/CC1/CC2/CC3/CC4/Text1/Text2/Text3/Test4 ▪ Digital Closed Caption: Service1/Service2/Service3/Service4/Service5/Service6/OFF |
| <hr/> | | |
| 17 | EXIT | Exits the OSD menu |
| <hr/> | | |
| 18 | 0-9/ENTER | Pressing a number selects a channel. Following selection, pressing ENTER activates the channel, or channel activates automatically in 3 seconds |
| <hr/> | | |
| 19 | INPUT | Pressing INPUT to display a source list, use ▲▼ buttons to select the video equipment connected to the video inputs of your LCD TV: TV/VIDEO1/VIDEO2/VIDEO3/VIDEO4/VIDEO5/VIDEO6/VIDEO7/COMPUTER |
| | • | In TV mode, use with 0-9 and ENTER buttons to select a digital channels |

The operation of each OSD control is described in the following table:

Menu	Options	Sub-Options	Function and Description	
VIDEO	Picture Mode	Vivid →Hi-Bright →Cinema →Sport→User.	Press repeatedly for different picture modes: Vivid →Hi-Bright →Cinema→Sport →User.	
	Contrast	0...100 (75)	Fine tune the contrast.	
	Brightness	0...100 (50)	Fine tune the brightness.	
	Saturation	0...100 (50)	Fine tune the contrast.	
	Hue	-30...+30 (0)	Fine tune the contrast.	
	Sharpness	0...7 (4)	Fine tune the contrast.	
	Color Temperature	Cool		Set the color temperature type.
		Middle		
		Warm		
		User	Red/Green/Blue: -19...+19	
	Noise Reduction	Off / Low / Strong / Medium		Select to reduce the noise level of connected equipment: Off / Low / Strong / Medium.
	VGA	Auto Adjust		Press the OK button to automatically adjust the display settings to optimize the performance based on the VGA mode.
		H. Position		Adjusts the position of the picture left and right in the window.
		V. Position		Adjusts the position of the picture up and down in the window.
CLOCK			Controls the width of the picture based on the VGA mode.	
Phase			Controls the signal phase. It can improve the focus clarity and image stability based on the VGA mode.	
AUDIO	Bass	0...100 (50)	Fine tune the bass value.	
	Treble	0...100 (50)	Fine tune the treble value.	
	Balance	-50...+50 (0)	Fine tune the balance value.	
	Sound Effect	Surround		Select the preset effect mode to match your music type and achieve stunning effects.
		Live		
		Dance		
		Techno		
		Classic		
		Soft		
		Rock		
		POP		
Off		Close this function.		
MTS	Mono		Set the sound type, which is only available when input source is TV.	
	Stereo			
	Sap			
SPDIF Type	PCM, OFF, Dolby Digital		Allows the selection of the digital sound format: PCM / OFF / Dolby Digital.	
Audio Language	English / Spanish / French		Allows the selection of the audio language: English / Spanish / French.	
Speaker			Allows the selection of turning the TV speakers on or off.	

TV	Channel Scan	Auto search channels.	Auto-search channels and put the programs into memory.
	Tuner Mode	Cable	Select the tuner mode.
		Air	Cable_STD/HRC/IRC Auto detect
	Channel Skip	Set the channel that you want to skip.	If a channel is set to SKIP, when scanning up/down channels the selected channel will be skipped.
Time Zone	Eastern Time, Indiana, Central Time, Mountain Time, Arizona, Pacific Time, Alaska and Hawaii	Set time zone.	
SETUP	OSD Language	English / Spanish / French	Set language.
	Closed Caption	Analog Closed Caption	Select one of the basic analog closed caption options: OFF / CC1 / CC2 / CC3 / CC4
		Digital Closed Caption	Select one of the digital closed caption options: Service1 / Service2 / Service 3 / Service4 / Service5 / Service6 / OFF
		Caption Style	Customize the settings for the digital closed caption option selected.
	Parental	Input Password	Enter a 4-digit pin code. The default pin code is "0000"
		Channel Lock	Set the channel that you want to lock.
		Video Lock	Set the input source that you want to lock.
		Change password	Input the old password first, and then input your new password.
	Gamma		Allows for the adjustment of the display's gamma correction. It fine tunes both brightness and the red / green / blue ratios: On / Off / Middle.
	Reset Default		Restores factory settings.

3. Troubleshooting / Flow Charts

Note: Reseat all cables, check fuse by AC plug, perform a clear or reset in factory mode and retest before ordering parts.

Can't power on your TV?

This TV is equipped with a safety fuse. In the event of an electrical storm or power outage the safety fuse is designed to protect your TV. If your TV has no power, check the fuse by prying the cover off, following the illustration below. If the fuse is blown, replace with a 4 A 250 V – 5 x 20 mm Time Lag Fuse (Slow Blow) fuse.

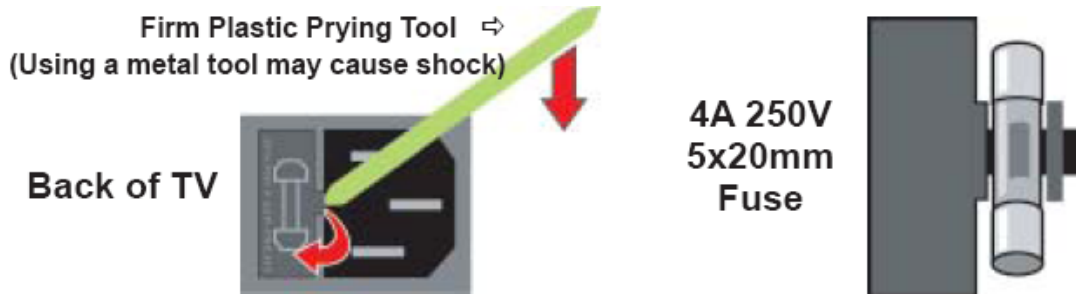

Having trouble with setting your Parental Controls (V-Chip)?

The factory preset password is 0000. This password must be used first before setting your own personal password. It is recommended that you keep your personal password in a safe place and away from children. In the event you lose your personal password the master password is 8202. The master password overrides all passwords. The master password can't be changed and should be kept in a safe place away from children.

Having trouble with setting Picture-in-Picture settings?

The Picture-in-Picture will not work using Component 1 and Component 2 as the input sources.

Factory Mode Procedure

- (1) Power on TV.
- (2) Press volume up and channel up buttons on the TV simultaneously and release.
- (3) Power off TV with remote or power button to exit.

STEP 1.

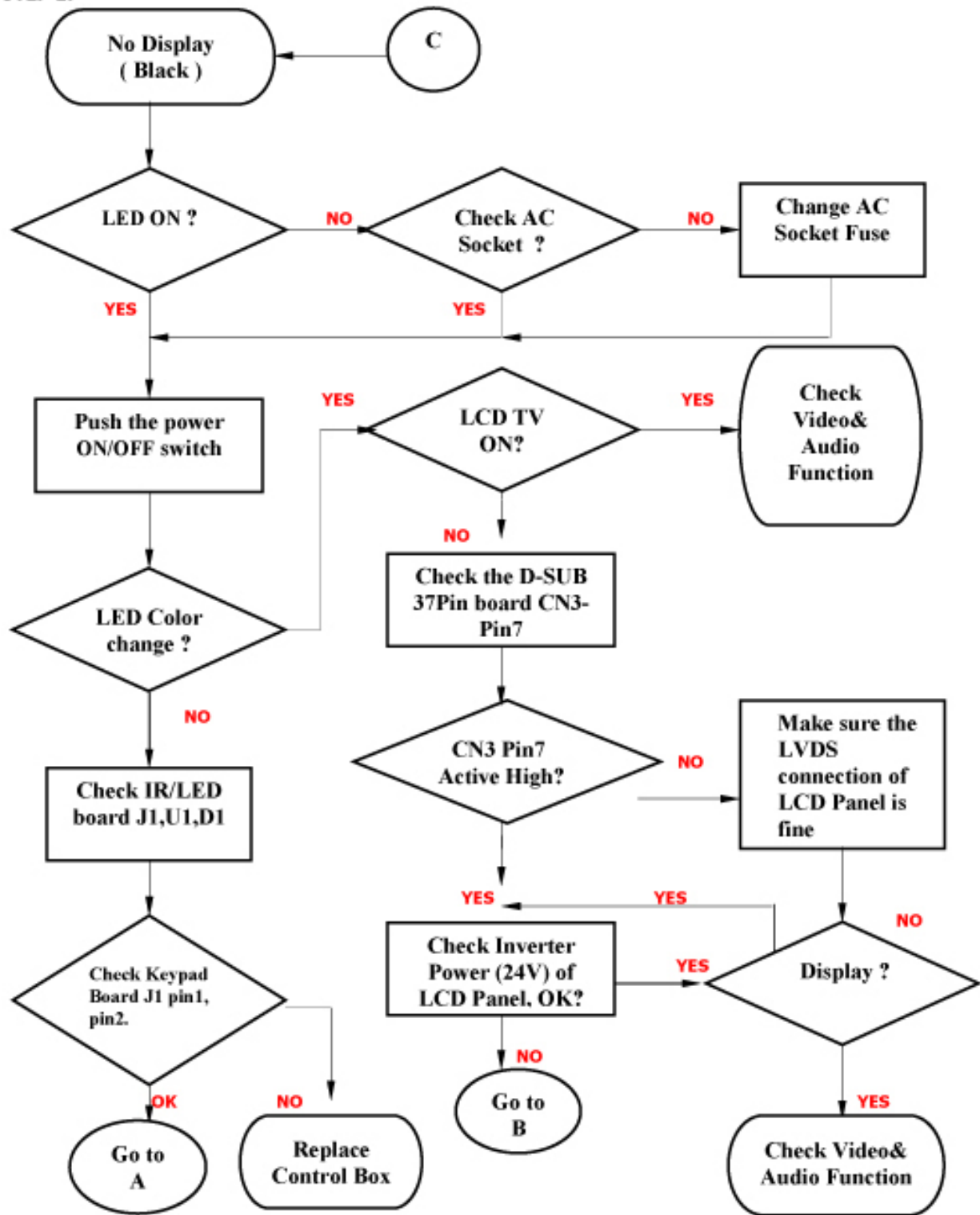

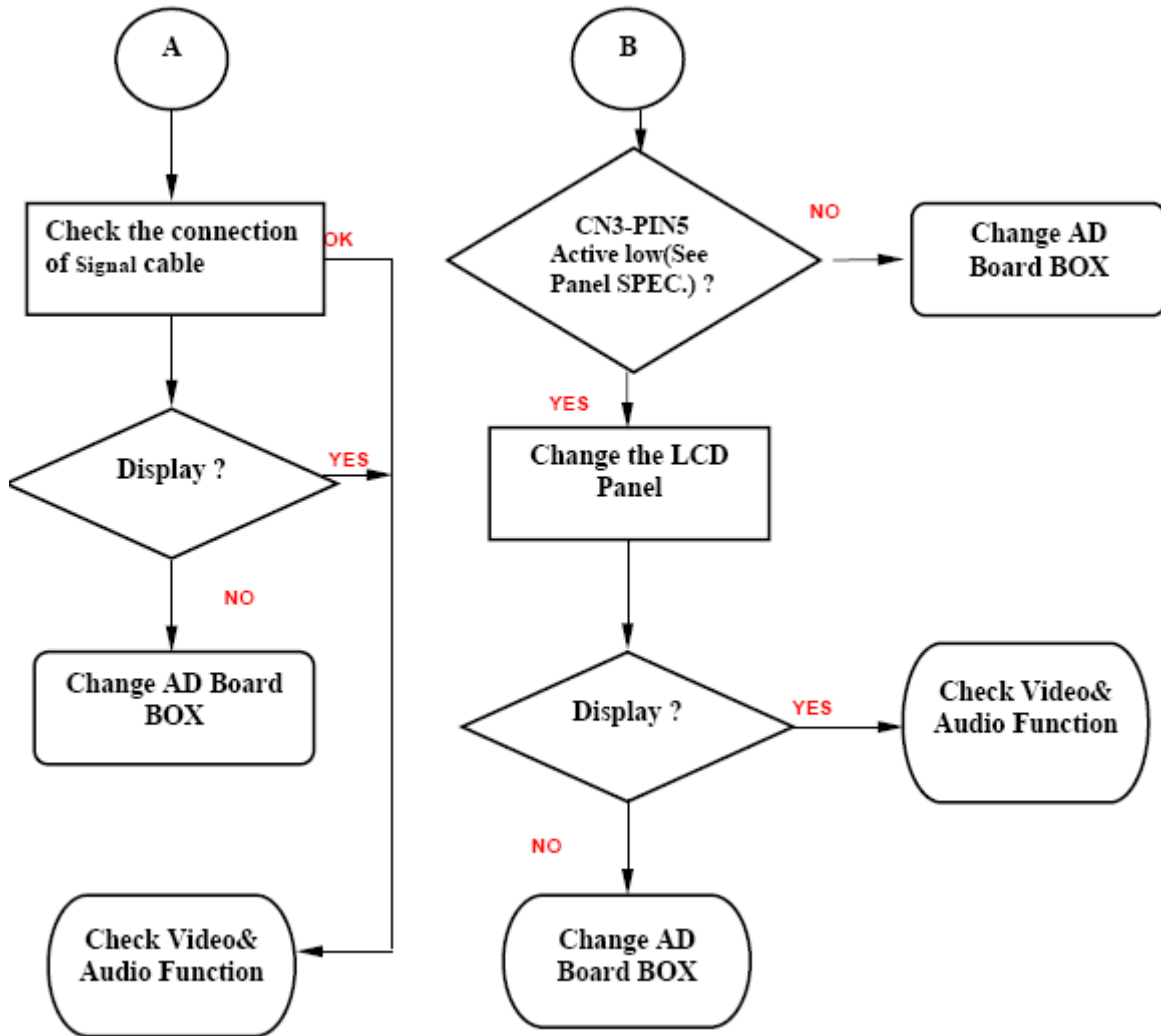

STEP 2.

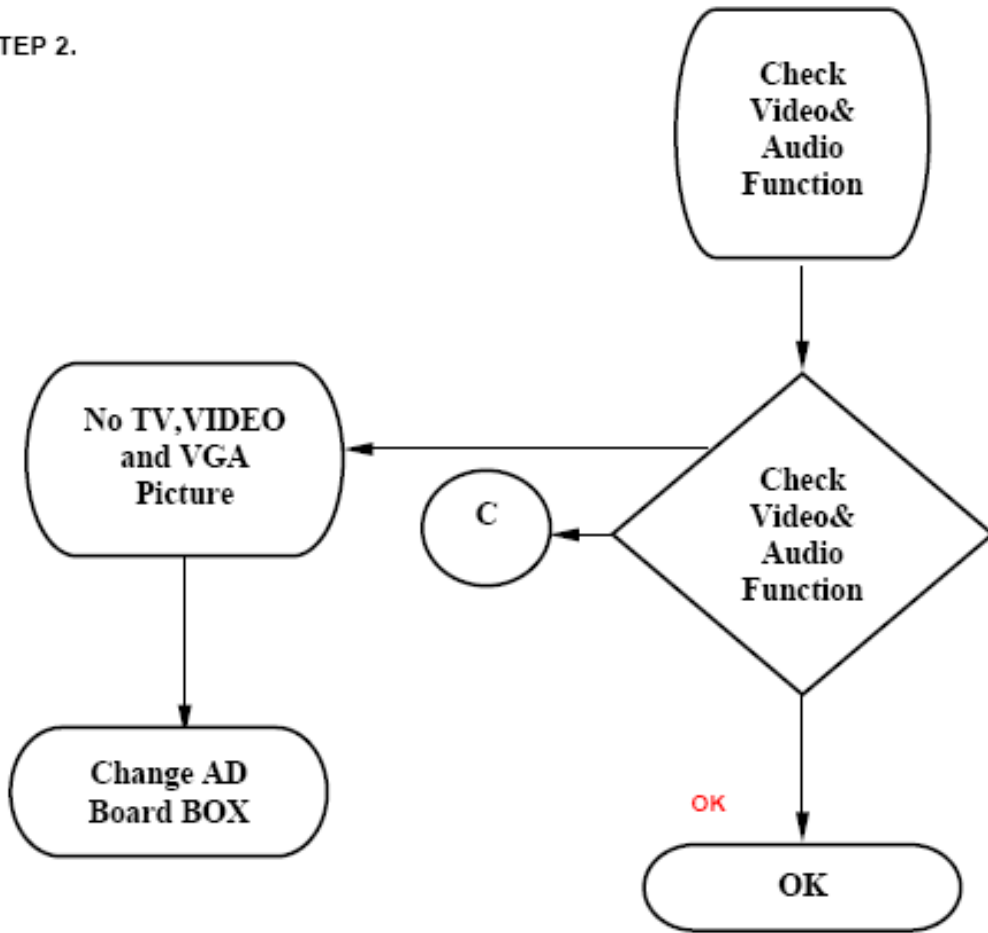

STEP 3.

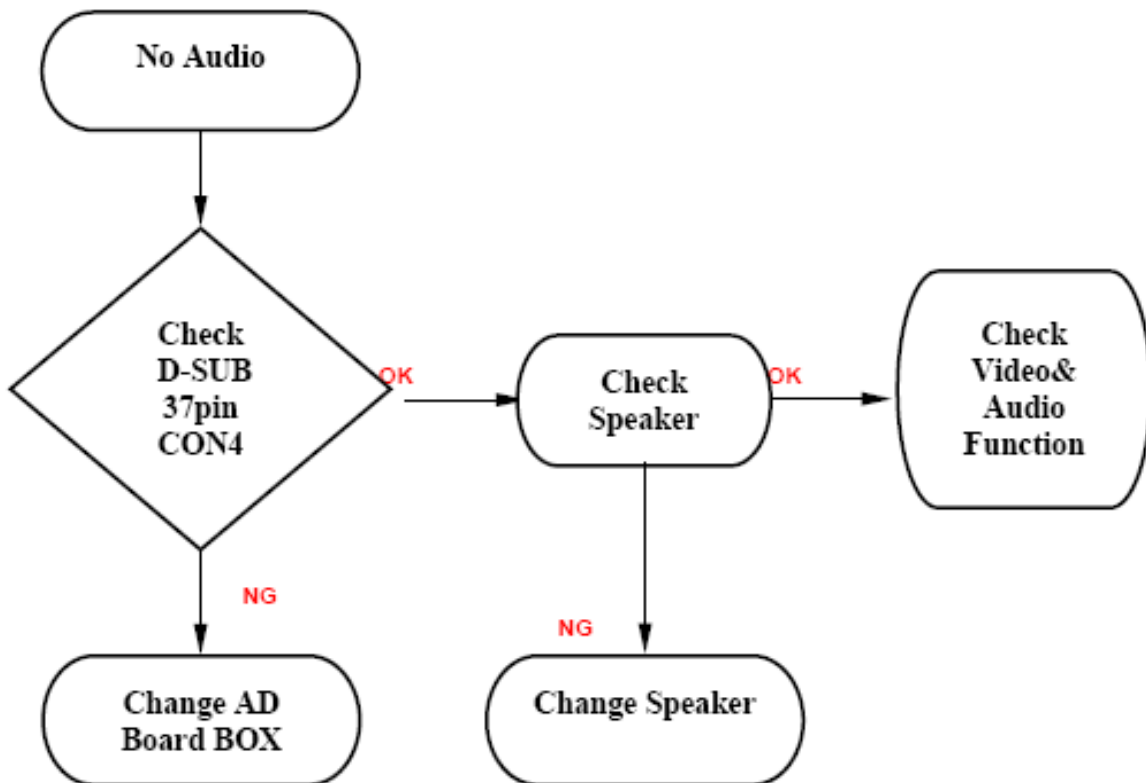

4. Polaroid Display Cell Defect Specification

In some cases, a panel may have defective cells that cannot be controlled.

These defective cells can be categorized into two types;

- (1) Non-lighting or dark cell defect: defect in which the cell is always off
- (2) Non-extinguishing or bright cell defect: defect in which the cell is always on

The Polaroid Display Cell Defect Specifications below define the allowed limits for display cell defects and are used as the criteria in determining whether an LCD panel is replaced.

7 or more defective pixels across the entire LCD screen Polaroid will repair (replace LCD panel) or replace the TV.

5. Before Returning This Product to the User

Before returning this product to the user, always perform the following safety checks:

- (1) Inspect all wiring to be sure no wires are pinched between the chassis or any metal parts.
- (2) Inspect all protective devices for proper installation, including non-metallic controls, insulation materials, cabinet backs, compartment covers, and shields.
- (3) Verify that no shock hazard exists on any part of the chassis, especially any metal components including cable connection points, chassis hardware, or antennas (if equipped). Use the following procedure:
 - a. Plug the AC cord directly into a 120 V AC outlet.
 - b. Create a test circuit consisting of a 1.5k ohm, 10 watt resistor paralleled by a 0.15 μ F capacitor.
 - c. Using an AC voltmeter (sensitivity of 5000 ohm per volt or higher), measure the voltage drop across the test circuit between all exposed metallic parts and a known earth ground. Measurement points can vary slightly even between revisions of the same model, so always conduct a thorough review of the chassis to locate metal points that a user may touch.
 - d. Any voltage reading of 0.375 Vrms AC (0.25 mArms) or higher indicates a potential shock hazard. **THIS CONDITION MUST BE CORRECTED BEFORE RETURNING THE PRODUCT TO THE USER!**
 - e. Repeat the above checks with the AC polarity reversed. A non-polarized adapter is required to reverse the polarity; DO NOT LEAVE THIS ADAPTER WITH THE USER! Under normal operation the product must use the proper polarity.

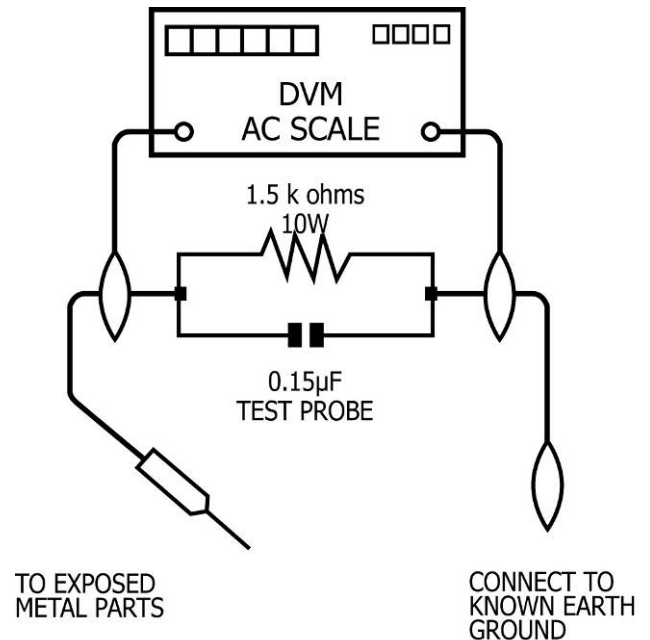

6. Disassembly Procedure



WARNING

Note: Before disassembly of any part the TV, make sure the power is OFF, and the power cord is removed from the wall outlet. Allow time for power within all system boards to discharge before you begin disassembly. Never insert any objects into the vent holes in the TV case.



CAUTION

Note: Before returning this product to the end user, you must follow the steps outlined in the section, *Before Returning This Product to the User*, on page 21. This procedure ensures that the chassis will not cause electric shock.

When servicing an LCD or plasma TV, always observe the following safety guidelines:

- Wear a grounding (ESD) wrist strap, and use a grounded or dissipative work mat.
- Use a stable and strong work surface that is large enough to hold components you might remove.
- When removing components that are attached with a cable, unplug the cable before removing the screws to avoid damaging the cable.
- Use a magnetized screwdriver for removing screws.
- To help keep track of screws, place each component's screws next to the component on your work surface.

ELECTROSTATIC DISCHARGE (ESD)

Components inside an LCD or plasma TV are sensitive to static electricity. Before servicing the TV, follow these guidelines:

- Avoid static-causing surfaces such as carpeted floors, plastic, and packing foam.
- Remove replacement components from their antistatic bags only when you are ready to use them. Do not lay components on the outside of antistatic bags because only the inside of the bags provide electrostatic protection.
- Always hold components by their edges. Avoid touching the edge connectors. Never slide components over any surface.
- Wear a grounding wrist strap (available at most electronics stores) and attach it to a bare metal part of your workbench or other grounded connection.
- Touch a bare metal surface on your workbench or other grounded object before touching any components.

Stand and Control Box Removal

Lay TV flat on workbench. Be careful to protect the front bezel and LCD screen from being scratched. Use protective cloth between work bench and TV front.



Note: Before disassembly of any part the TV, make sure the power is OFF, and the power cord is removed from the wall outlet. Allow time for power within all system boards to discharge before you begin disassembly. Never insert any objects into the vent holes in the TV case.

- (1) Remove 4 screws (A) from the TV Stand.

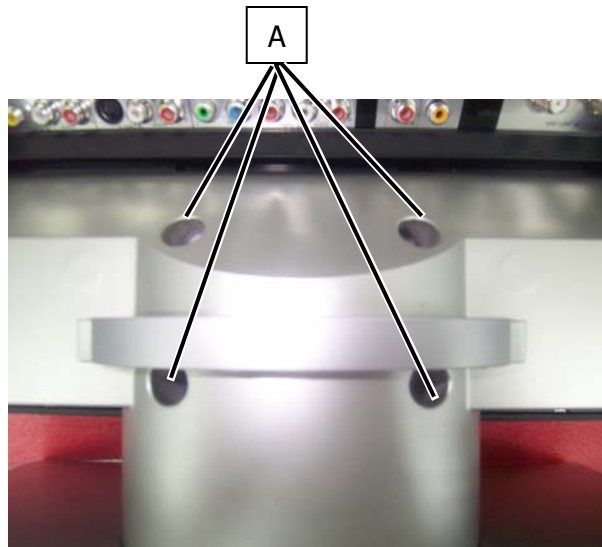

- (2) Remove 3 screws (A) from the Control Box Cover, and remove the Cover from the TV.

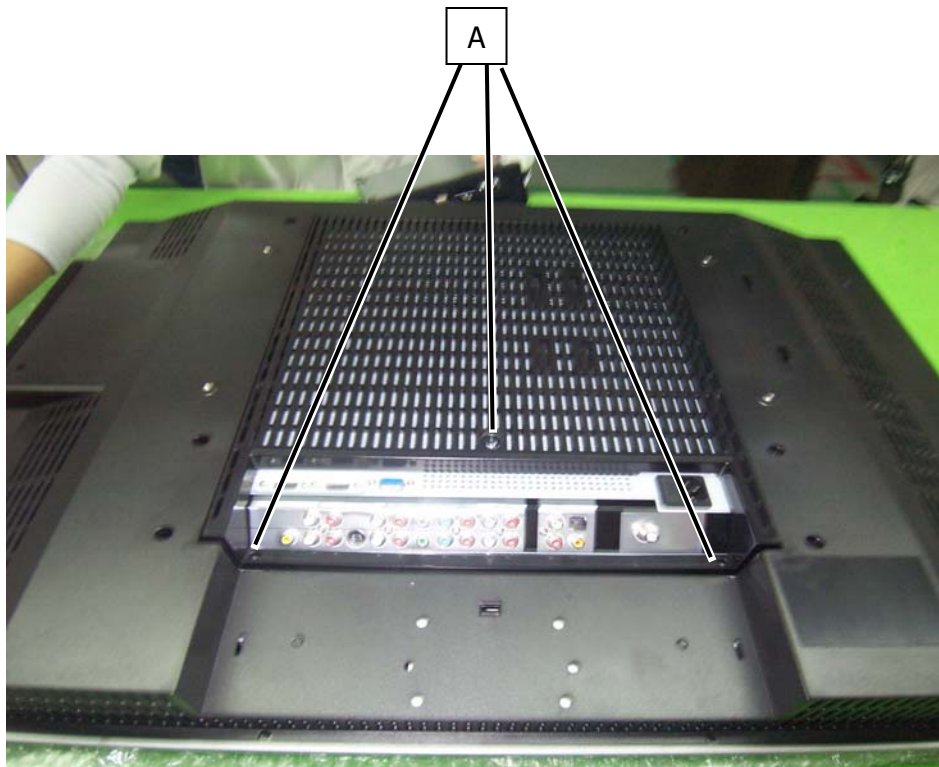

- (3) Remove 6 screws (A) from the Control Box.

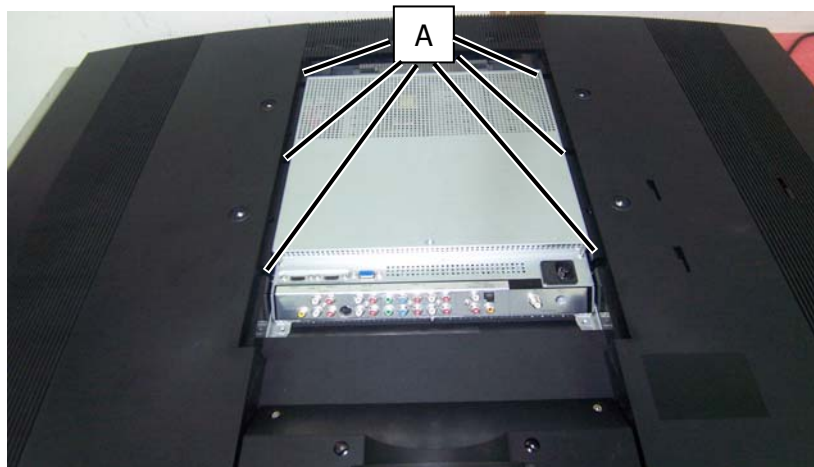

- (4) Lift the Control Box upwards, and then towards the bottom of the TV to unhook it.

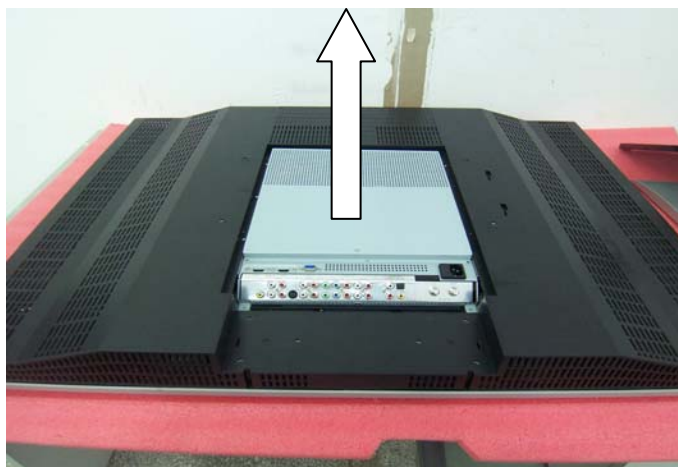

- (5) Remove the aluminum foil and bracket from the end of the Control Box. Unplug the 2 cables (A) from the Control Box, and remove the Box from the TV. Remove all remaining foam and aluminum foil, and save for re-use.

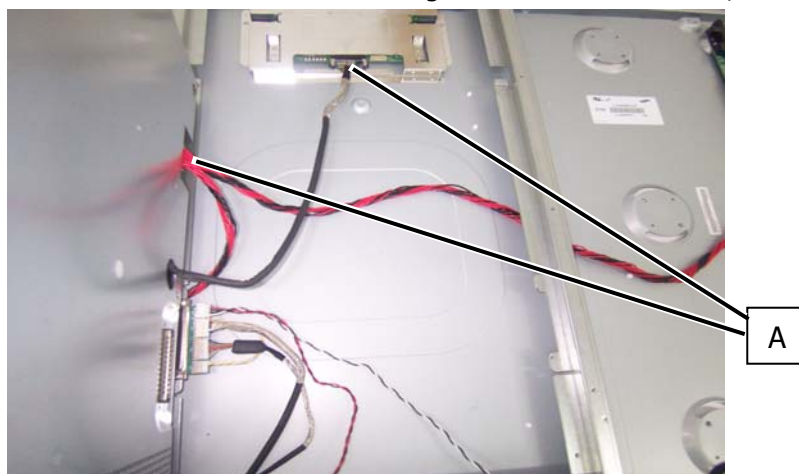

Note: Before returning this product to the end user, you must follow the steps outlined in the section, Before Returning This Product to the User, on page 21. This procedure ensures that the chassis will not cause electric shock.

Rear Cabinet Cover, LCD Panel and Front Bezel



Note: Before disassembly of any part the TV, make sure the power is OFF, and the power cord is removed from the wall outlet. Allow time for power within all system boards to discharge before you begin disassembly. Never insert any objects into the vent holes in the TV case.



Note: OEM LCD panels were used in production. The following LCD panel disassembly/removal instructions may not apply to all models. Ensure LCD panel is completely detached from the bezel before removing so the bezel is not damaged.

- (1) Remove 6 screws (A) from the rear cabinet cover.

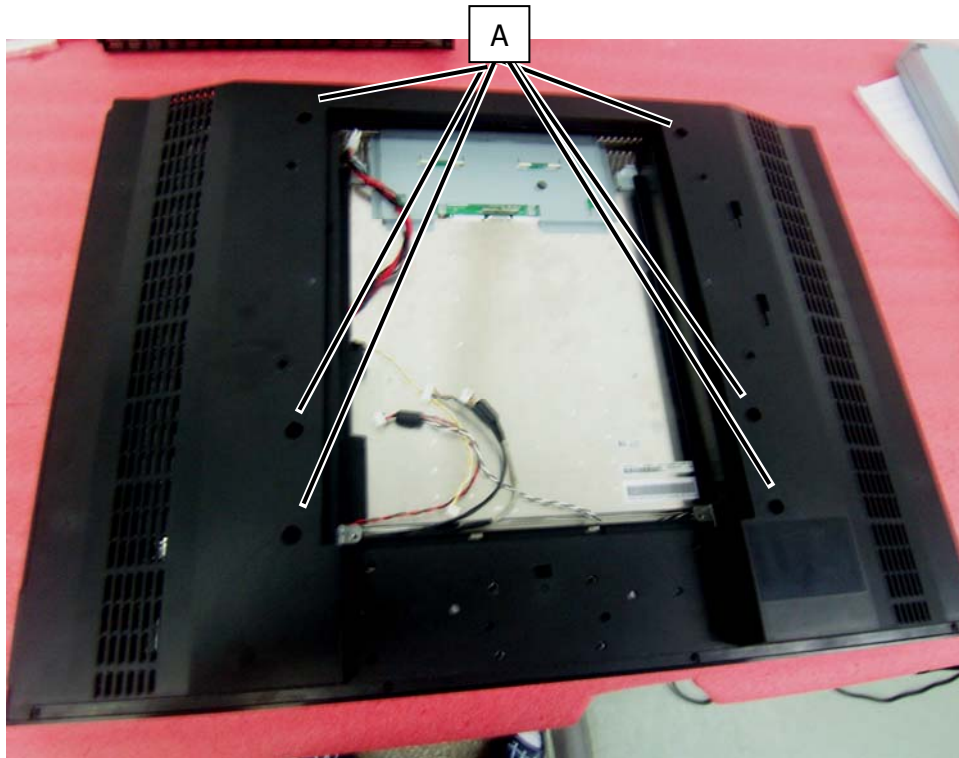

- (2) Remove 5 screws (A) from between the bezel and rear cabinet cover, and remove the rear cabinet cover from the TV.

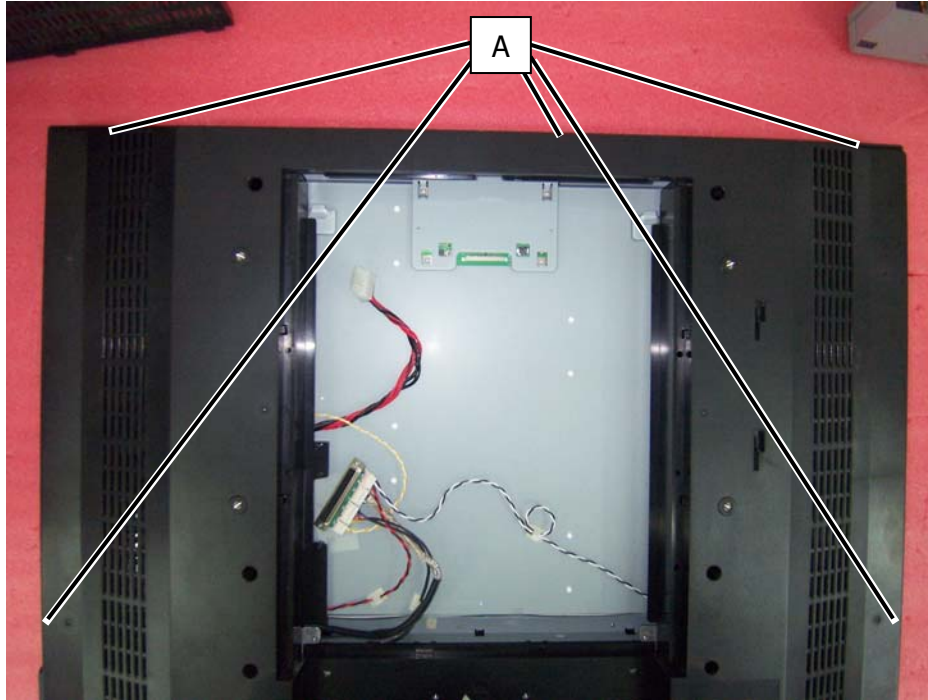

- (3) Remove 4 screws (A) from the bottom of the cabinet.

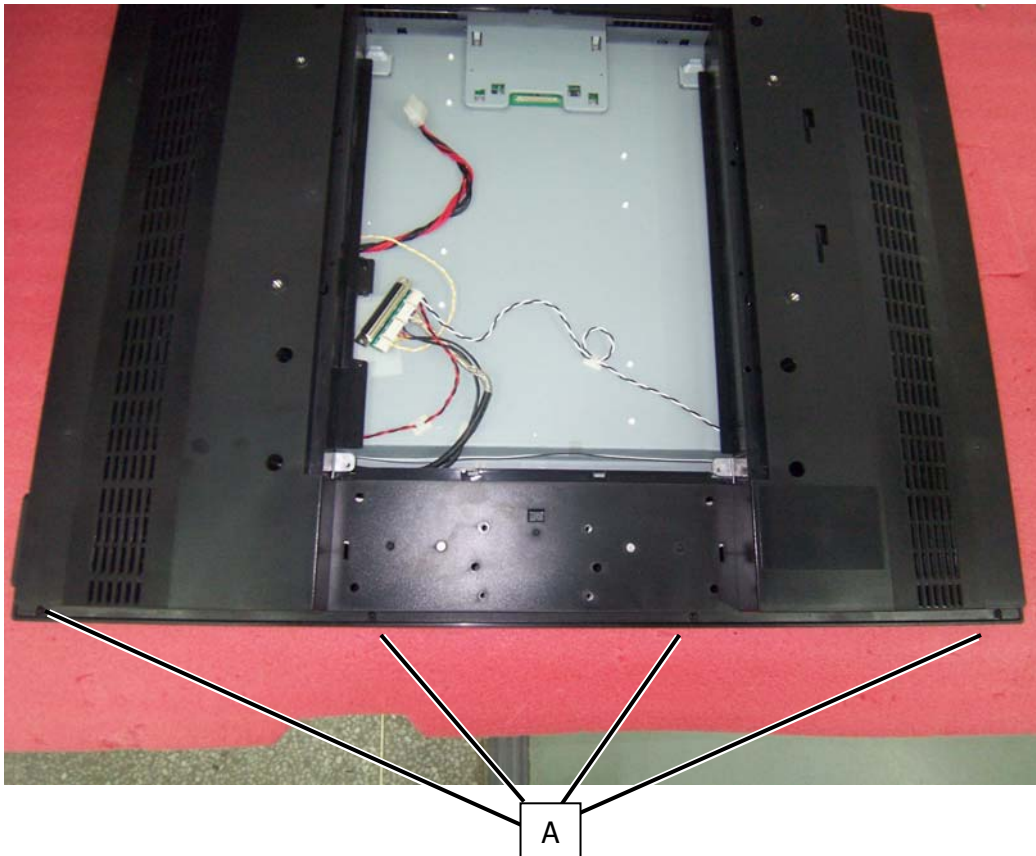

(4) Remove the foam and aluminum foil (A) and SAVE for reassembly.

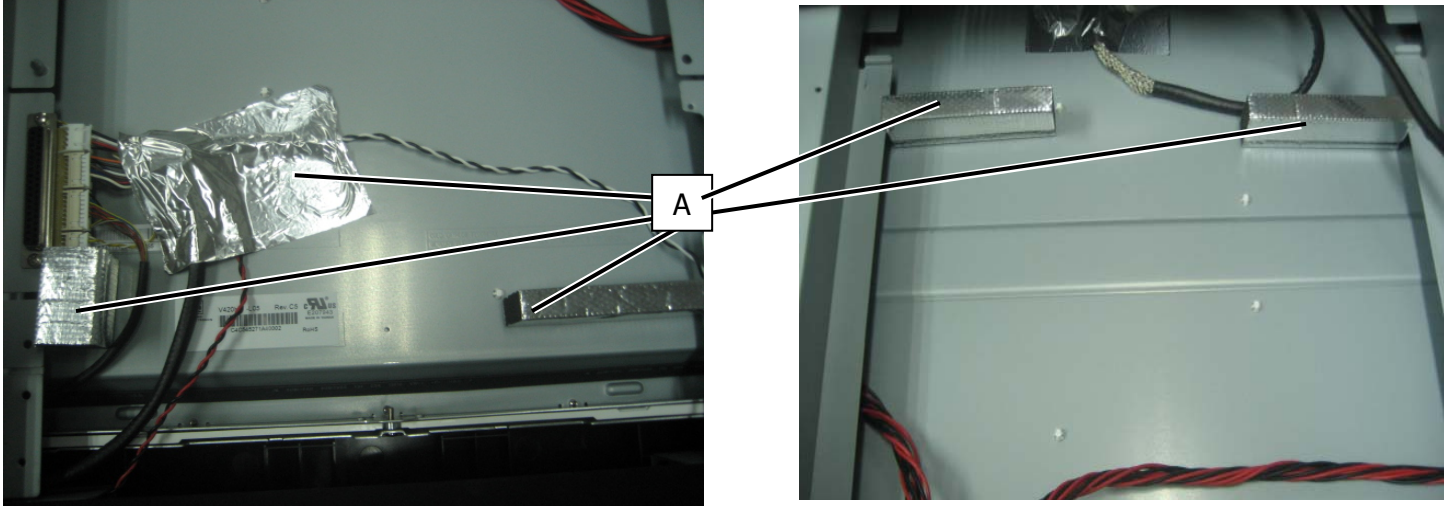

(5) Remove 2 screws (A) from the D-sub plate and unplug cable.

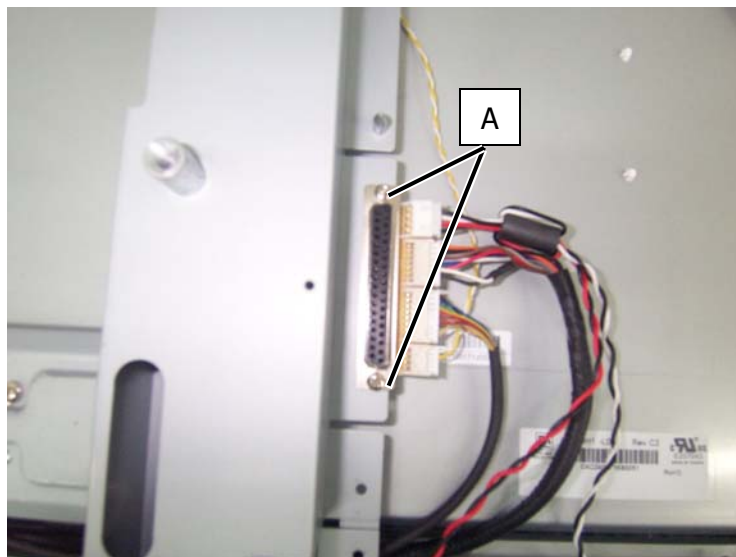

(6) Remove aluminum foil (A) (save for reassembly) and remove AV assembly (B).

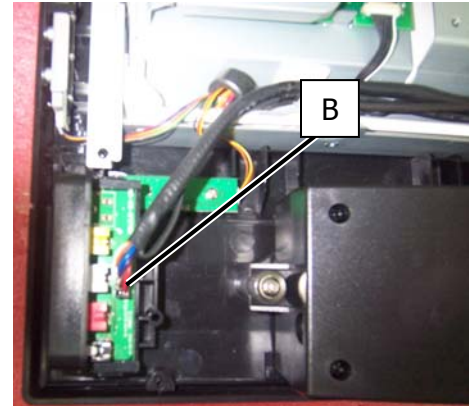
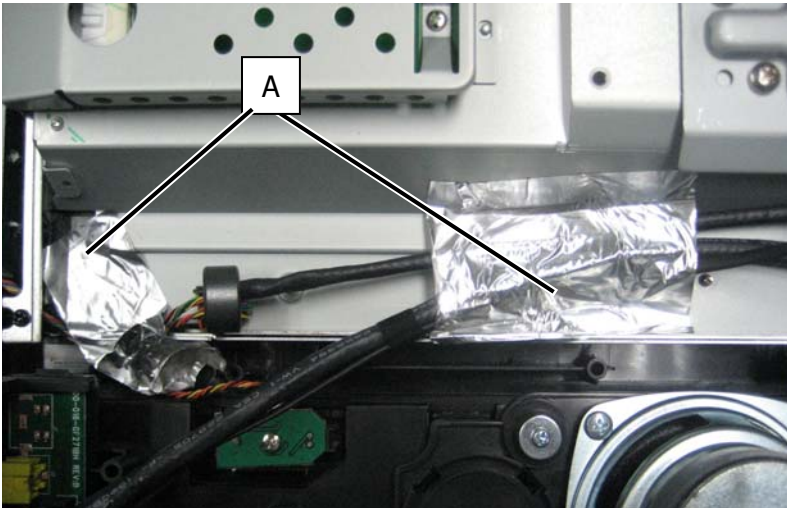

(7) Remove 8 screws (A) from right bracket, then do the same for the left and remove brackets.

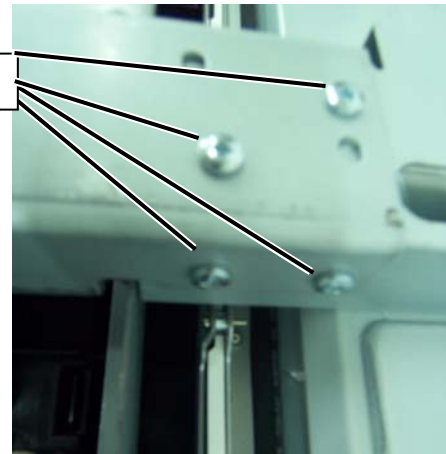
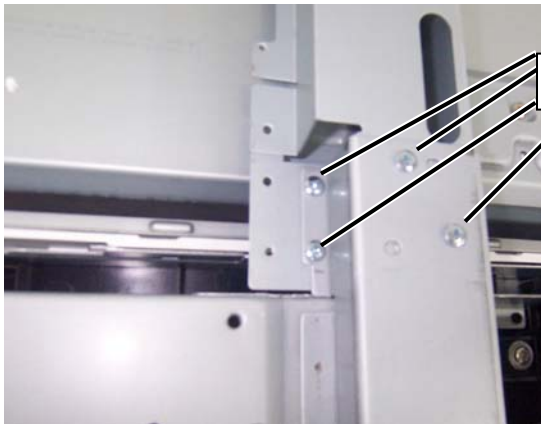

(8) Remove 4 screws (A) from right side panel and then do the same on the left panel and remove panel from bezel.

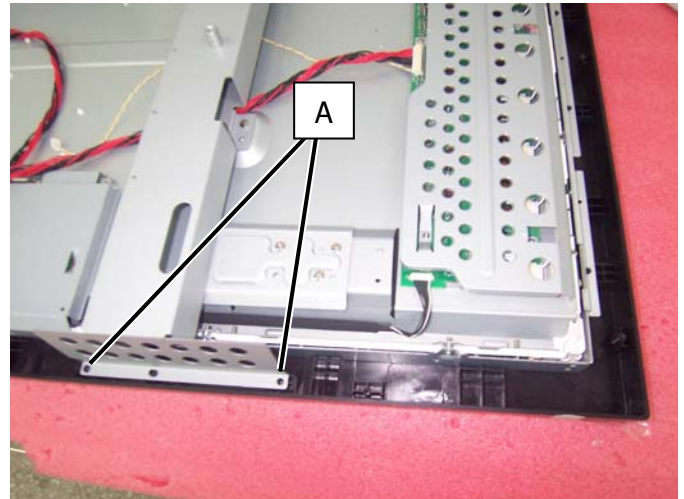
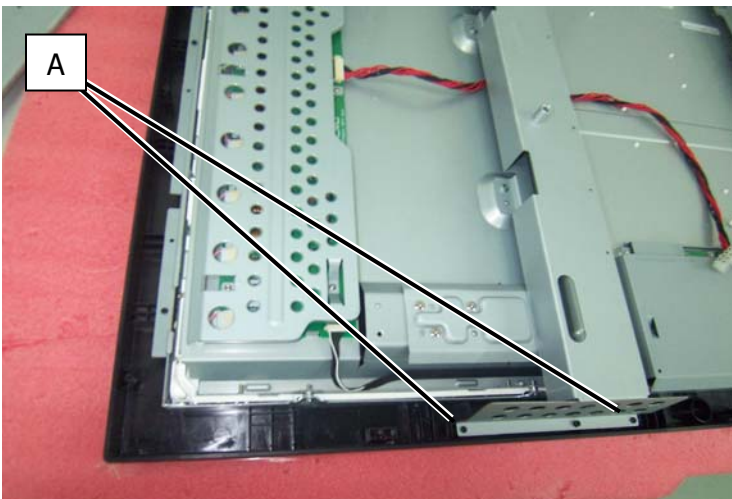

(9) Remove aluminum (A) (saving it for reassembly) from both side supports.

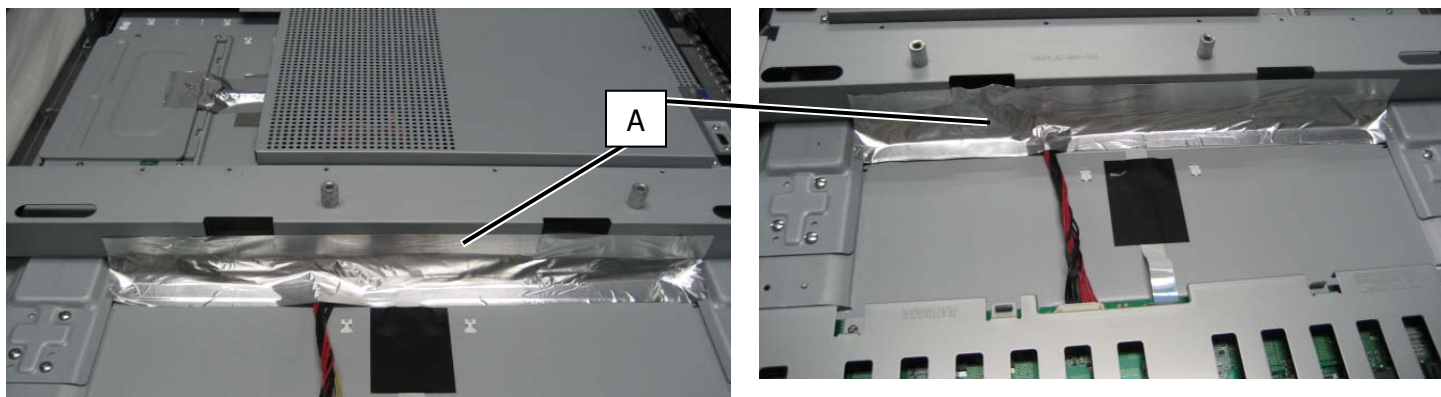

(10) On the left support bracket, remove 2 screws (A) from each end of the bracket and 2 screws (B) from the center. Remove bracket. Repeat procedure on the right bracket.

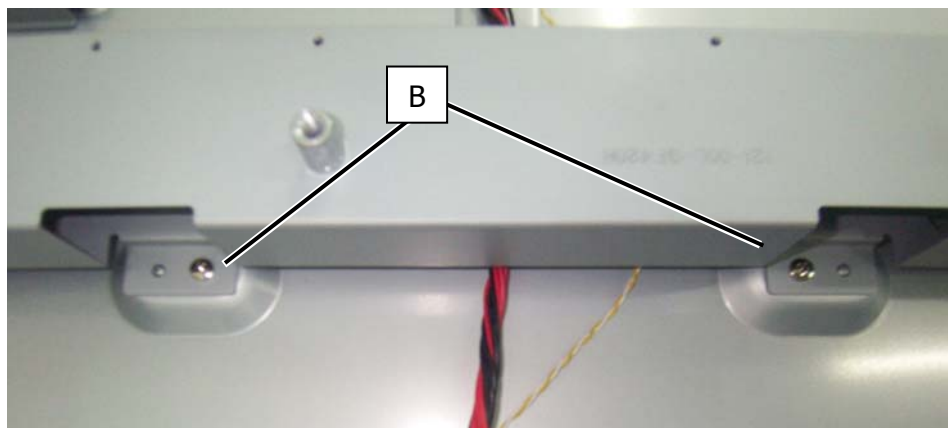
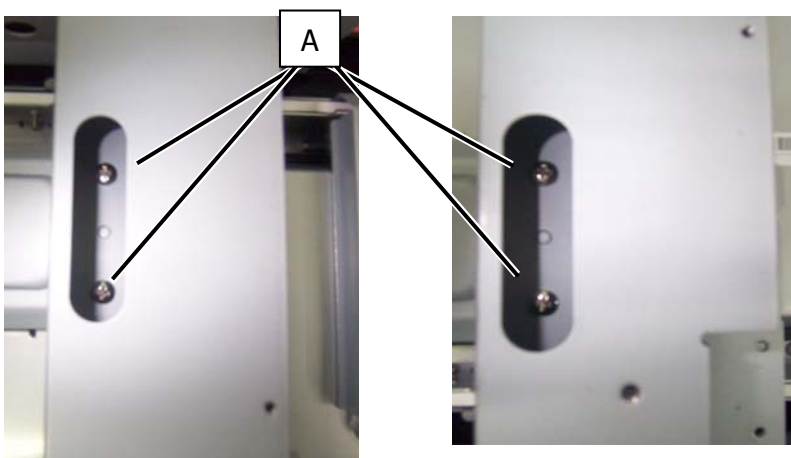

(11) On left end, remove 6 screws (A). Repeat procedure on right side.

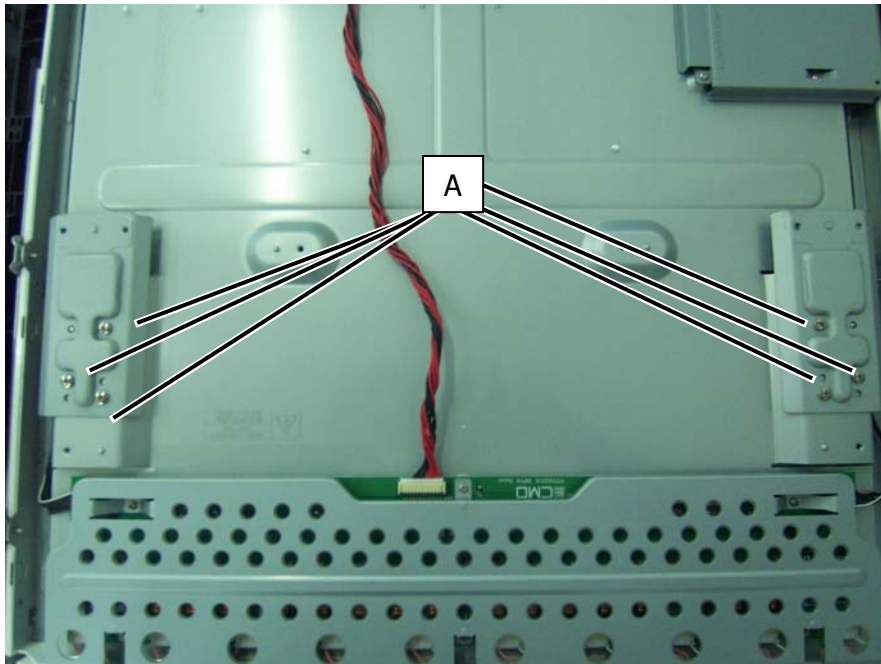

(12) Unplug the inverter cable (A) and remove it.

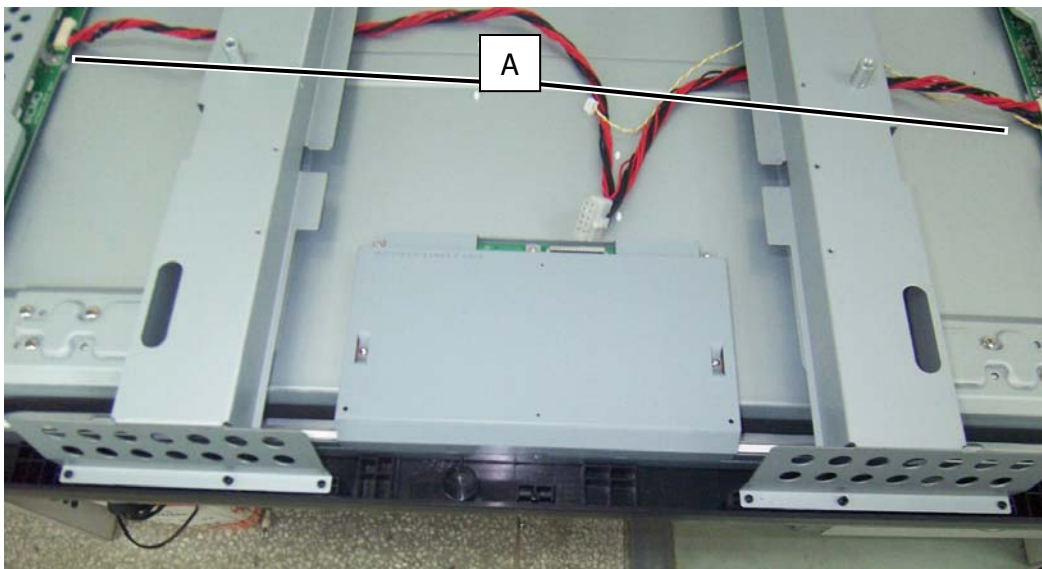

(13) Remove the 4 screws (4) on the right speaker. Repeat procedure for the left speaker.

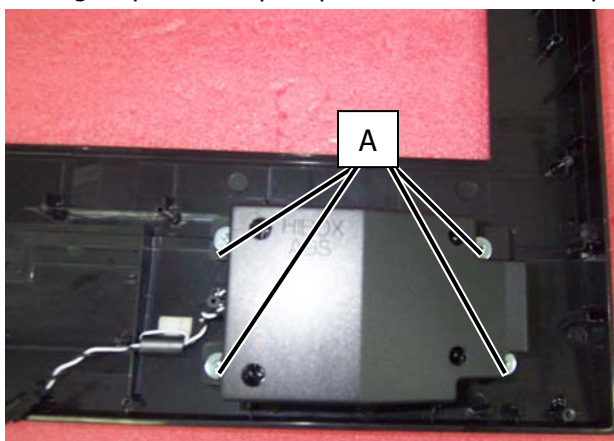

(14) Remove clip (A) from left speaker. Repeat procedure for right speaker.

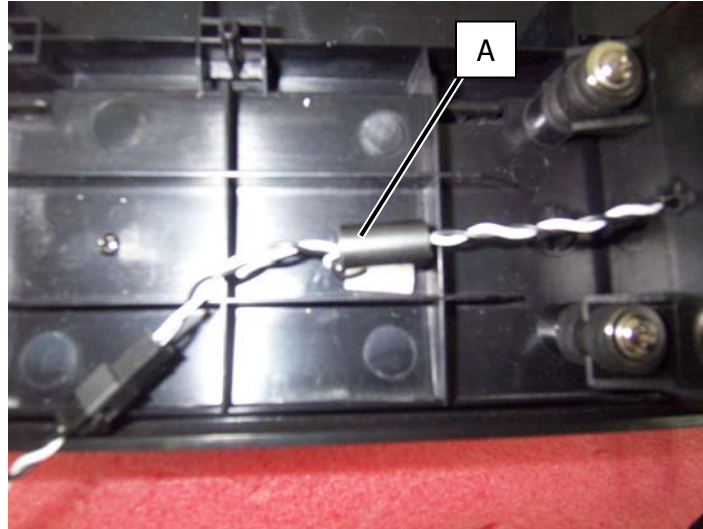

NOTE: To avoid damage, TWO PEOPLE ARE REQUIRED to lift the LCD Panel from the TV.



Note: Before returning this product to the end user, you must follow the steps outlined in the section, *Before Returning This Product to the User*, on page 21. This procedure ensures that the chassis will not cause electric shock.

IR Board Removal and Replacement



WARNING

Note: Before disassembly of any part the TV, make sure the power is OFF, and the power cord is removed from the wall outlet. Allow time for power within all system boards to discharge before you begin disassembly. Never insert any objects into the vent holes in the TV case.

- (1) Disassemble control box cover and rear cabinet cover.
- (2) Remove 8 screws (A) from front bezel and net cover.

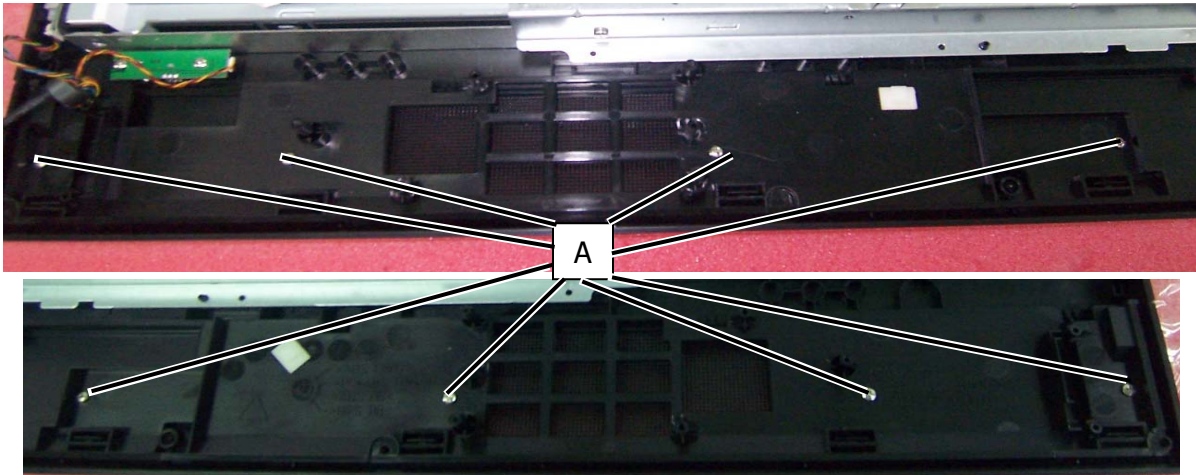

- (3) Remove 2 screws (A) from the IR Board, and remove the board from the TV.

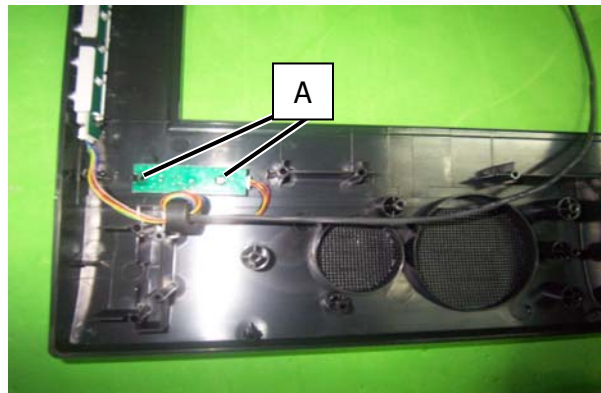

CAUTION

Note: Before returning this product to the end user, you must follow the steps outlined in the section, *Before Returning This Product to the User*, on page 21. This procedure ensures that the chassis will not cause electric shock.

Front/Side Control Buttons Removal and Replacement



WARNING

Note: Before disassembly of any part the TV, make sure the power is OFF, and the power cord is removed from the wall outlet. Allow time for power within all system boards to discharge before you begin disassembly. Never insert any objects into the vent holes in the TV case.

- (1) Disassemble control box cover and rear cabinet cover.
- (2) The control button board is attached with glue. Use alcohol to soften the glue and remove the control button board (A).

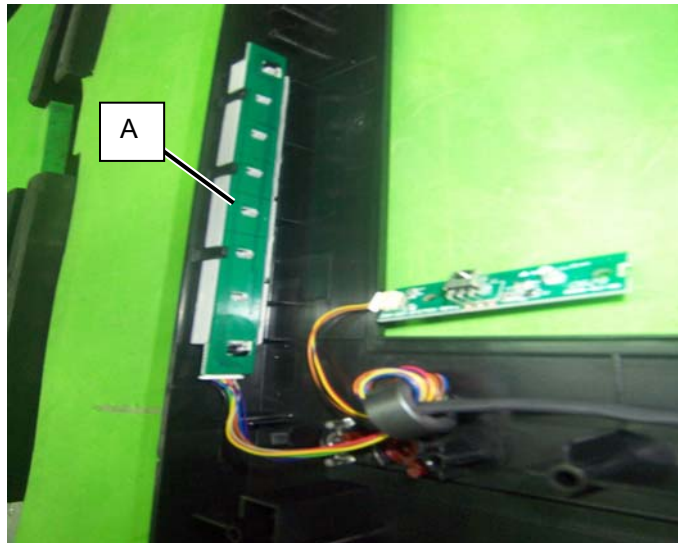

CAUTION

Note: Before returning this product to the end user, you must follow the steps outlined in the section, *Before Returning This Product to the User*, on page 21. This procedure ensures that the chassis will not cause electric shock.

7. Spare Parts Lists

Note: Reseat all cables, check fuse by AC plug, perform a clear or reset in factory mode and retest before ordering parts.

Polaroid Model TLA-04011C	
Part Number	Description
125-430-50POLAH	POLAROID LOGO
151-001-FU67G-AH	REAR CABINET
151-700-GF401XAH	40 STAND ASSY SILVER
151-A01-GF408BUPS0	FRNT BZL BLK/SILV
154-004-GF32WH	REAR COVER
154-501-GF370-AH	26-42 FRT/SIDE BTN CVR SILV
600-181-3200-LIH	AC POWER CORD (USA)
621-181-2000H	COMPOSITE VIDEO CBL
621-181-3020P-1H	COMPONENT CBL
621-181-60002H	AUDIO CABLE
631-030-JK401XA-AH	LVDS CABLE (SAMSUNG)
631-N14-JK401H	INVERTER CABLE (SAMSUNG)
705-540-011SH	40 LCD PANEL (SAMSUNG)
824-020-A002-MH	SPEAKER L-R
845-C45-GF1XA-PEH	26-46 UNIVERSAL REMOTE SILV/BLK
899-A00-GF271XAH	26-46 FRONT/SIDE AV INPUT BD
899-E00-GF271XAH	26-46 IR BOARD ASSY
899-K00-GF271XAH	26-46 FRNT/SIDE CONTROL BTN BD
909-KS2-GF4012XAPH	40 CNTRL BX (SAMSUNG)

Polaroid Model 4011-TLXB	
Part Number	Description
125-000-375POLAH	POLAROID LOGO
151-001-FU67G-AH	REAR CABINET
151-700-GF421UABH	40 STAND ASSY BLK/SILV
151-A00-FU68B7WH	FRNT BZL BLK/SILV (SAMSUNG)
154-004-GF32WH	REAR COVER
154-500-GF370H	26-46 FRNT SIDE CNTRL BTN CVR BLK
600-181-3200-LIH	AC PWR CBL
621-181-2000H	COMPOSITE VIDEO CBL
631-030-JK401XA-AH	LVDS CABLE (CMO, SAMSUNG)
705-540-011SH	40 LCD PANEL (SAMSUNG)
824-020-A002-MH	SPEAKER L-R
845-C45-GF1XA-PEH	26-46 UNIVERSAL REMOTE SILV/BLK
899-A00-GF271XAH	26-46 FRONT/SIDE AV INPUT BD
899-E00-GF271XAH	26-46 IR BOARD ASSY
899-K00-GF271XAH	26-46 FRNT/SIDE CONTROL BTN BD
909-KS1-GF4012XAPH	40 CNTRL BX (SAMSUNG L11)

Polaroid Model 4241-TLXB

Part Number	Description
125-000-375POLAH	POLAROID LOGO
151-001-OV57GH	42 REAR CABINET
151-700-IF4211UAPH	42 STAND ASSY BLK
151-A00-IF429R7WC0	42 FRNT BEZEL BLK/BLK
154-500-GF370H	26-46 FRNT SIDE CNTRL BTN CVR BLK
600-181-3200-LIH	AC POWER CORD
621-181-2000H	COMPOSITE VIDEO CBL
631-030-GF421XA-CH	LVDS CABLE
705-542-001CH	42 LCD PANEL (CMO L05)
824-020-A002H	SPEAKER L-R
845-C45-GF1XA-PEH	26-46 UNIVERSAL REMOTE SILV/BLK
899-A00-GF271XAH	26-46 FRONT/SIDE AV INPUT BD
899-E00-EF321XPH	IR BOARD ASSY
899-K00-GF271XAH	CNTRL BUTTON BD FRT
909-SKD-IF4213UAPH	42 CNTRL BX (CMO L05)

8. Exploded View Diagram

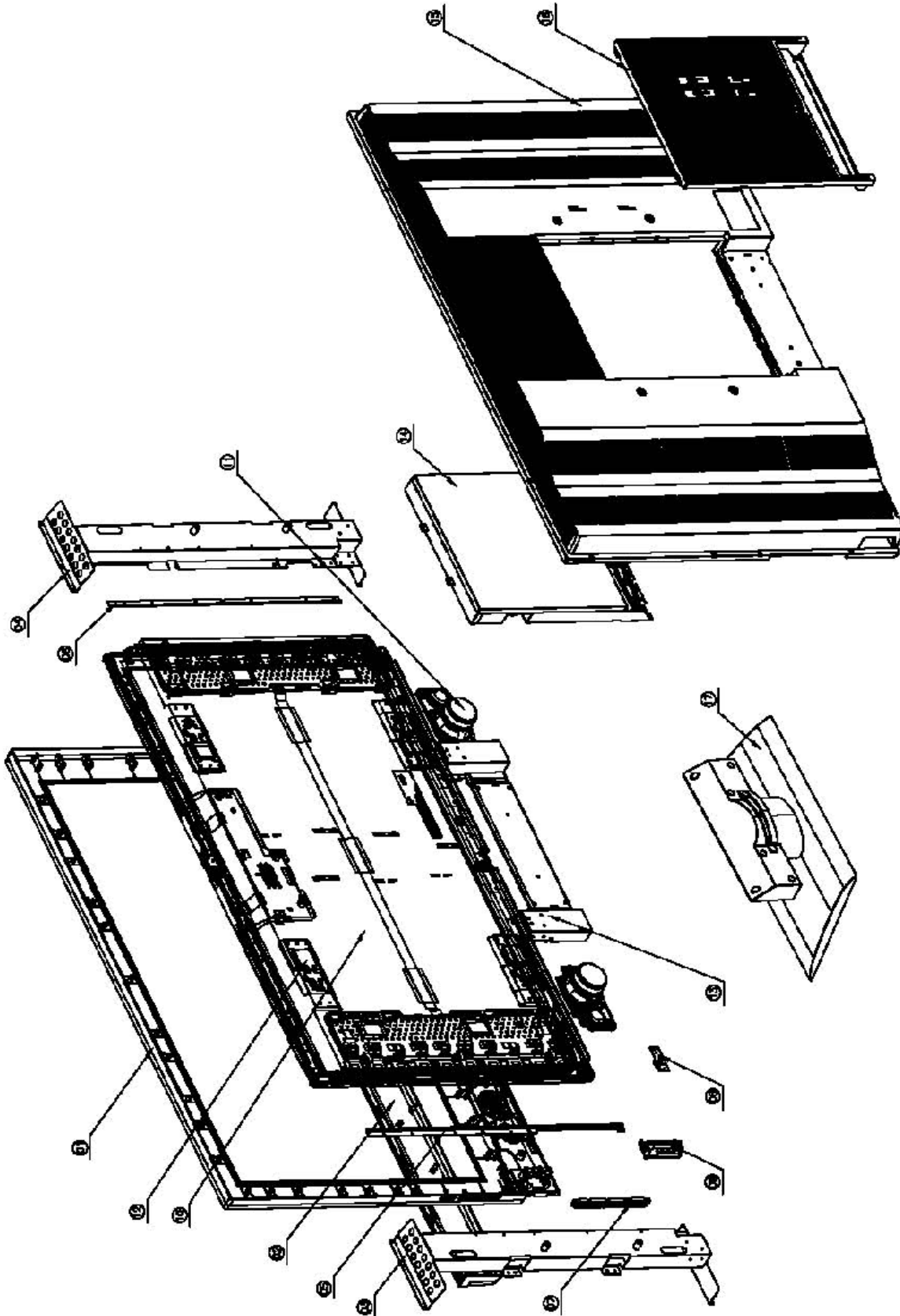

9. Block Diagram

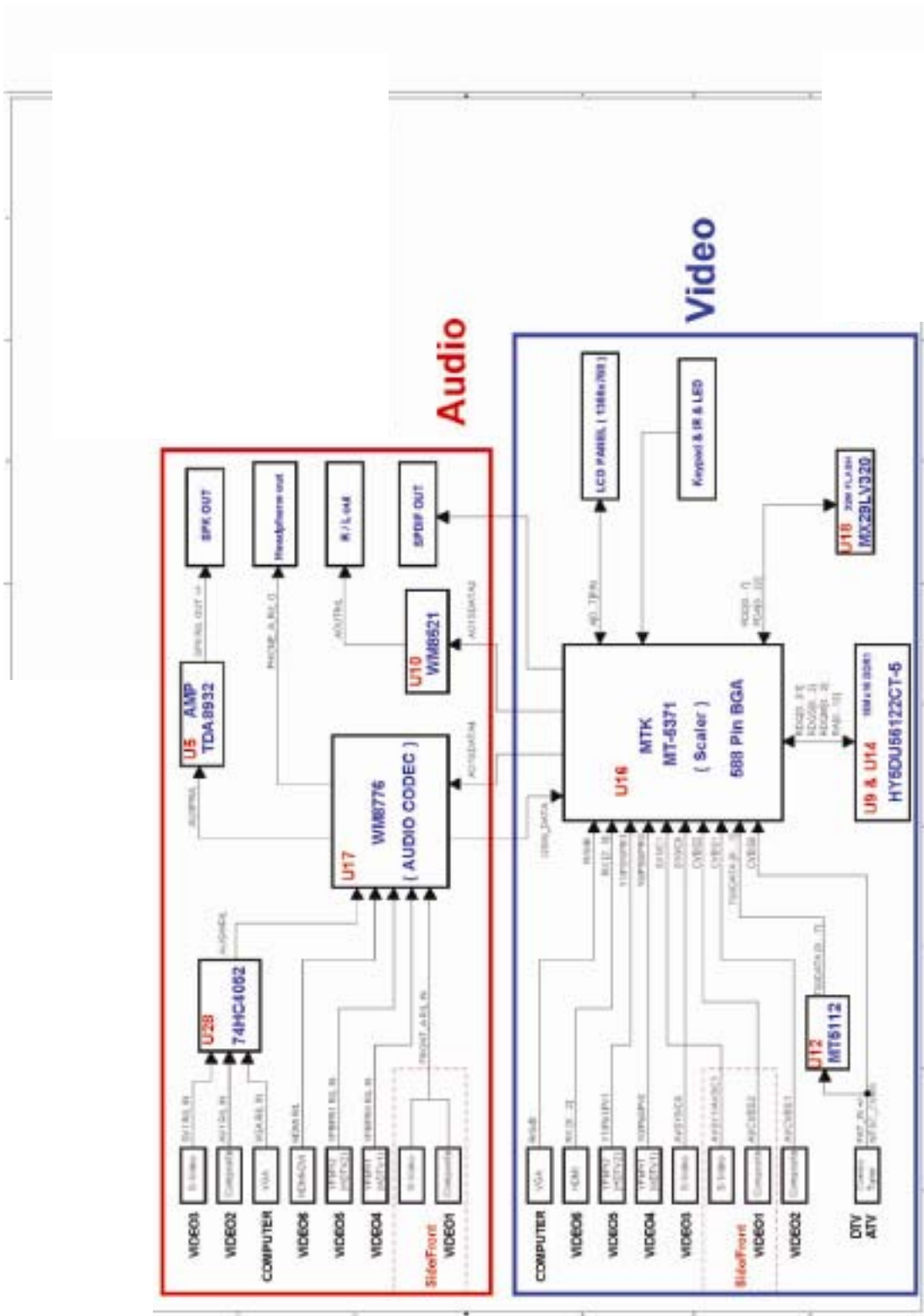

10. Schematics

Power

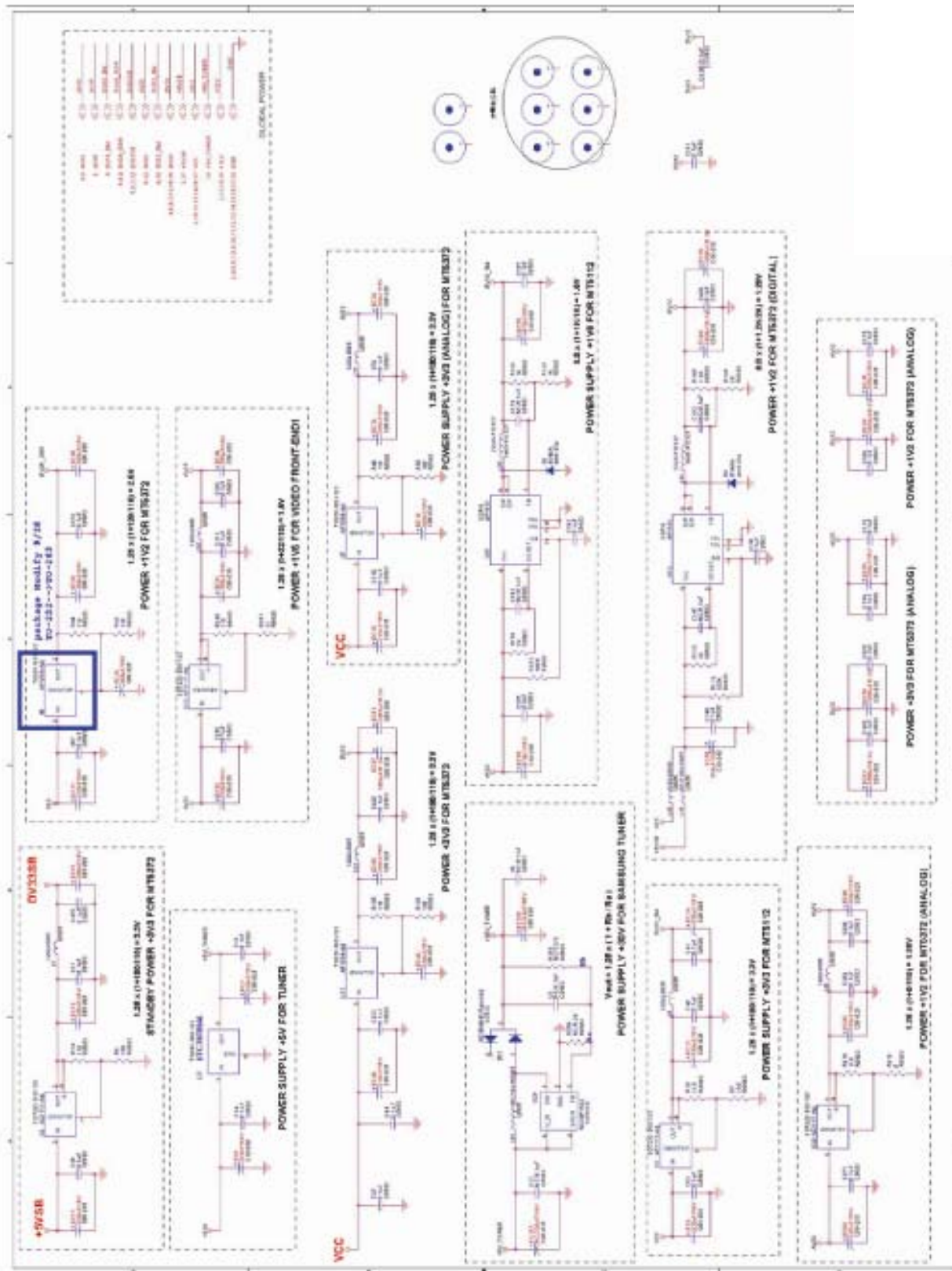

VGA Input

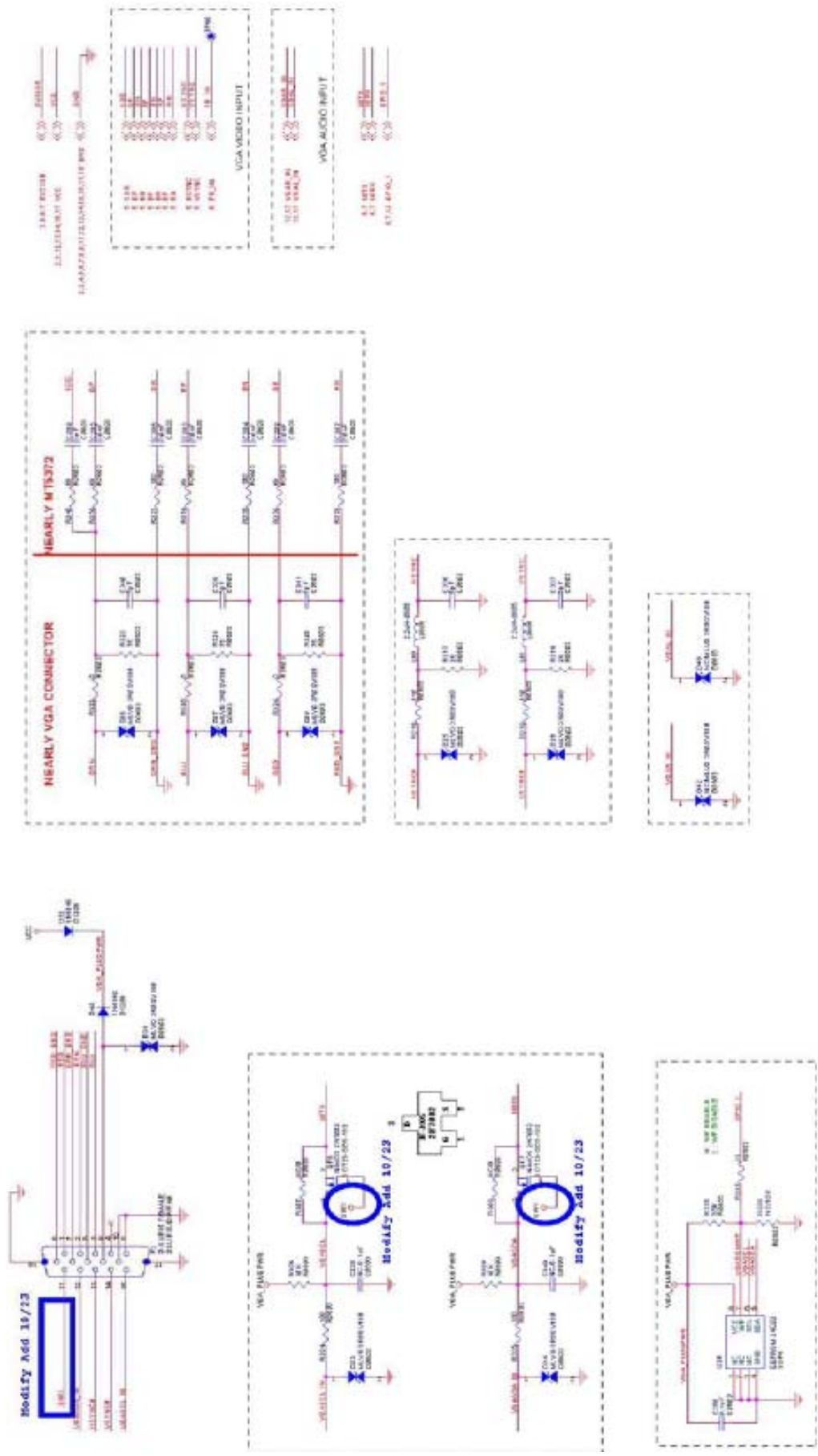

YPBR Input

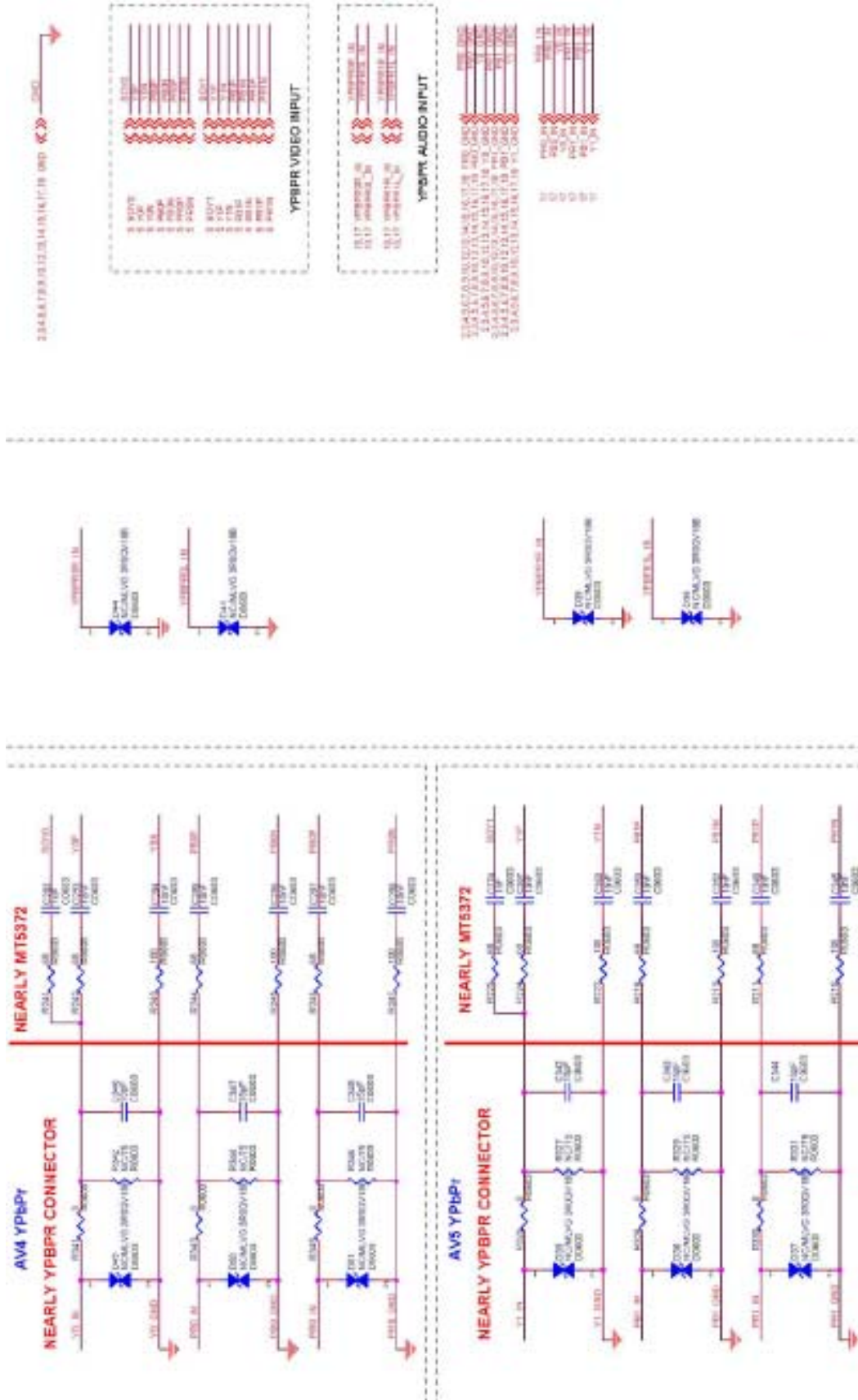

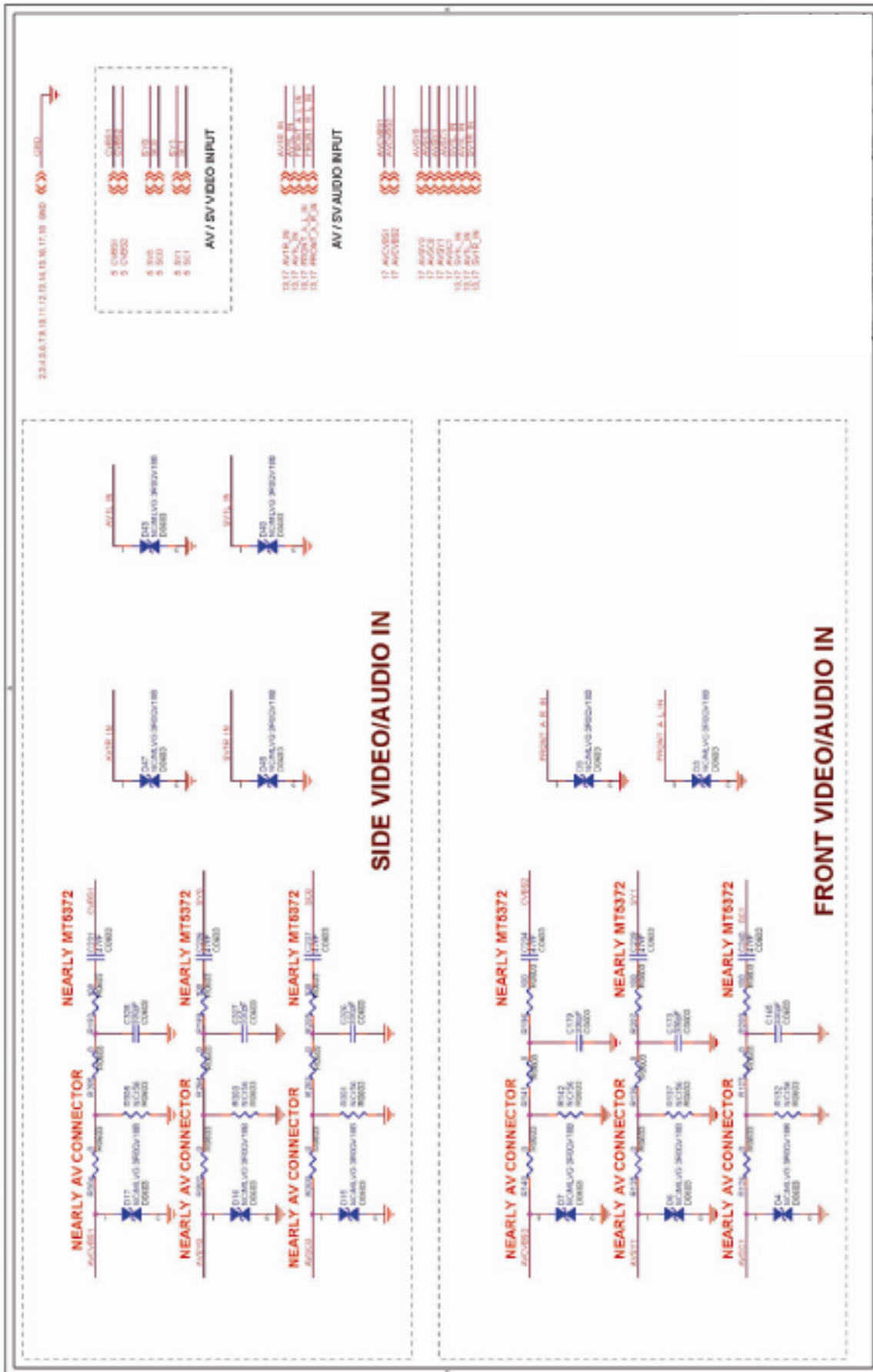

Tuner Input

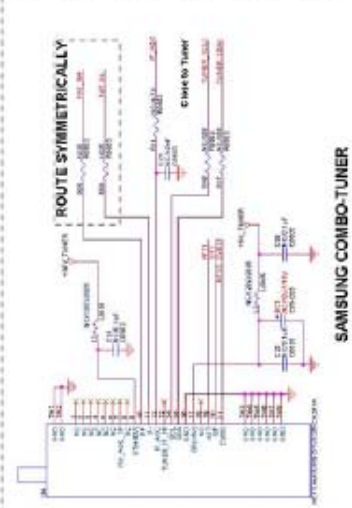
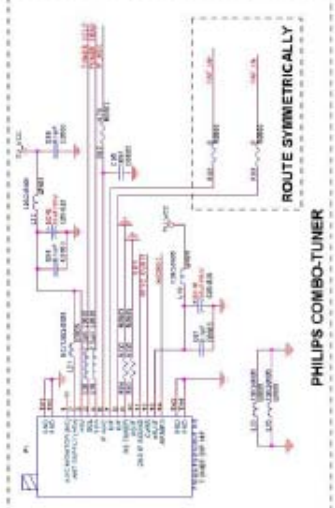
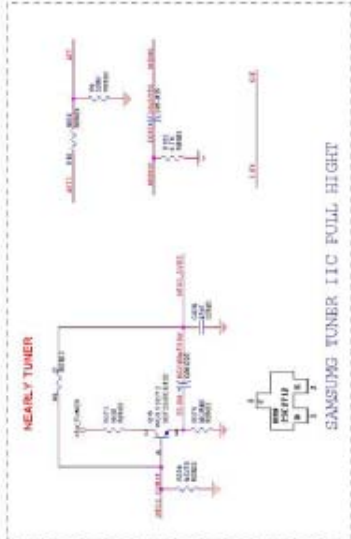
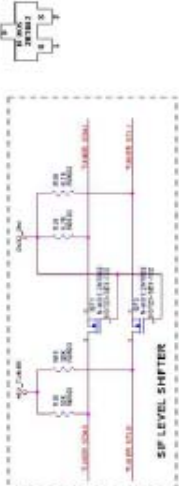
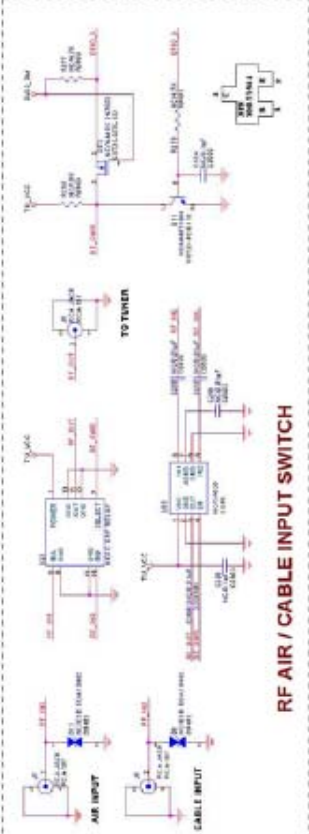
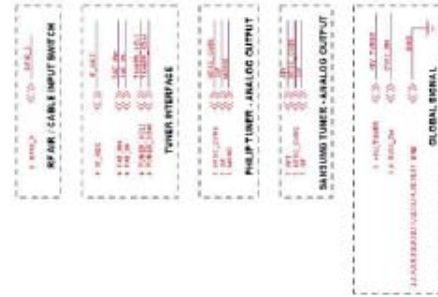

IR Sensor/LED Board

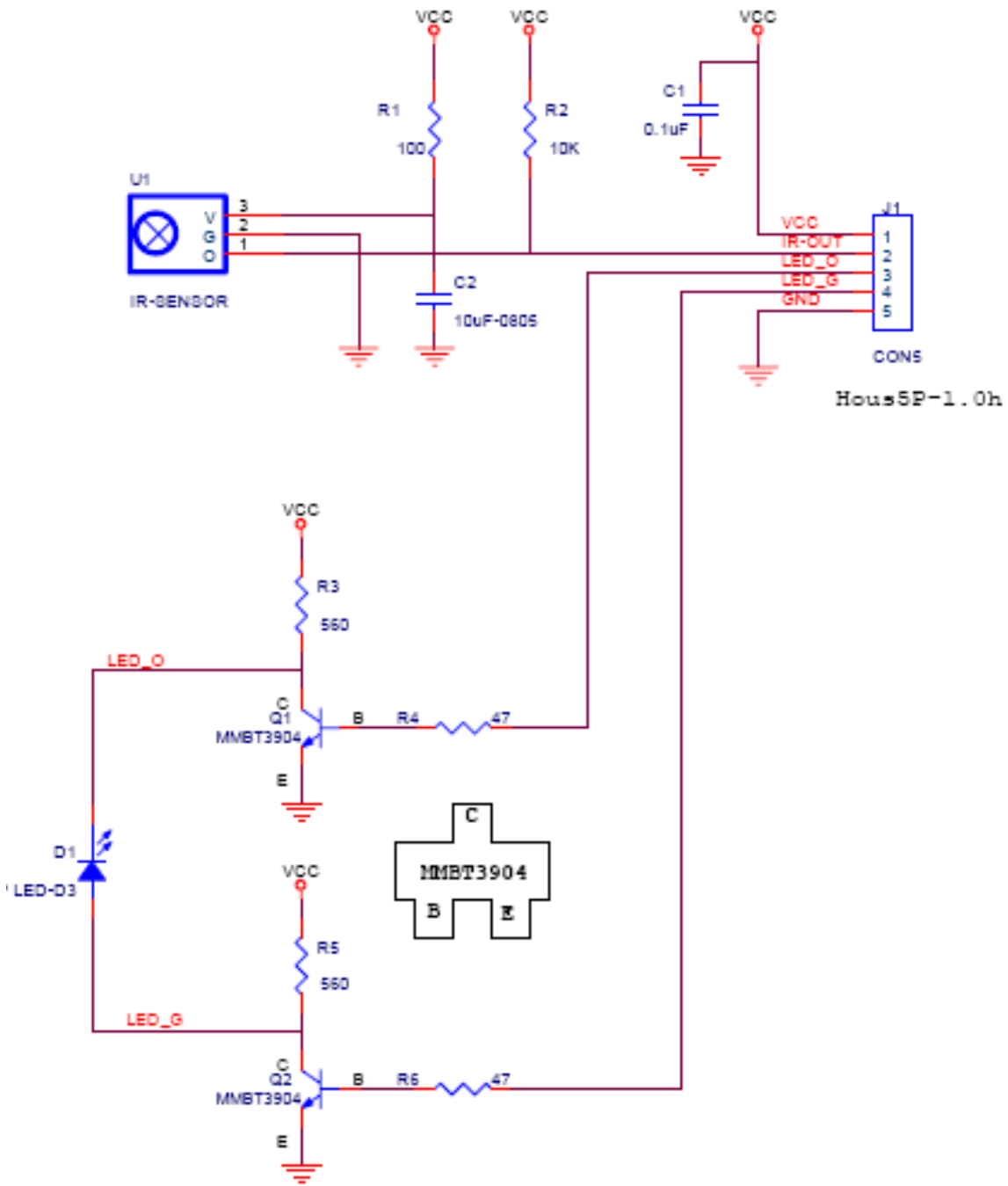

HDMI connector is a type A receptacle for video/audio mode.

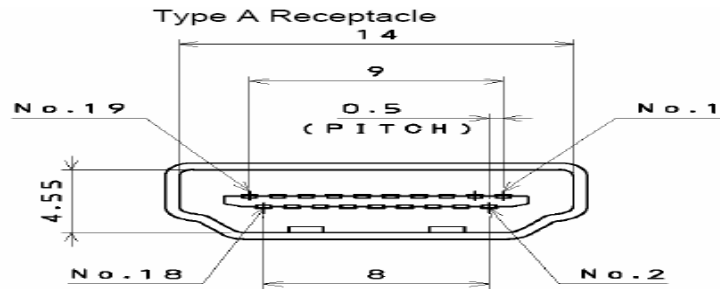

1. TMDS Data 2+	9. TMDS Data 0-	17. CEC/GND
2. TMDS Data 2 shield	10. Clock +	18. +5V Power
3. TMDS Data 2-	11. Clock shield	19. Hot Plug Detect
4. TMDS Data 1+	12. Clock -	
5. TMDS Data 1 shield	13. CEC	
6. TMDS Data 1-	14. NC	
7. TMDS Data 0+	15. DDC CLK	
8. TMDS Data 0 shield	16. DDC DATA	

D-Sub Connector IN. (This function also can provides to HDTV.)

D-Sub type Connector pin assignment		
1. Red Video	6. Red Ground	11. GND
2. Green Video	7. Green Ground	12. SDA For DDC1/2B
3. Blue Video	8. Blue Ground	13. H-sync.
4. GND	9. +5V from PC	14. V-sync.
5. Vdd from PC for DDC	10. Sync. GND	15. SCL For DDC1/2B

RCA jacks are all female type.

Mini DIN CNC 4 Pins (SCN570S3NS00000) for S-video, the pin assignment is described as below:

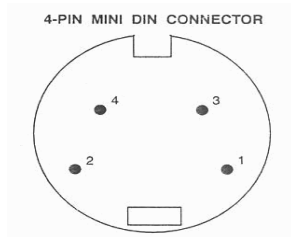

- 1: Ground
- 2: Ground
- 3: Y
- 4: C

Signal Connector Pin Assignment

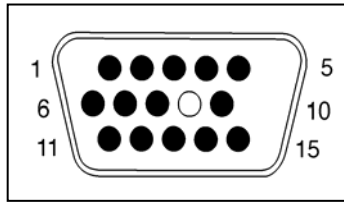

Pin	Assignment	Pin	Assignment	Pin	Assignment
1.	Red	6.	Red Ground	11.	Ground
2.	Green	7.	Green Ground	12.	SDA
3.	Blue	8.	Blue Ground	13.	Horizontal Sync.
4.	Ground	9.	Not Connected	14.	Vertical Sync.
5.	Self Test	10.	Sync. Ground	15.	SCL

11. PCB Layout Diagrams

Keypad Board (Component Side Top)

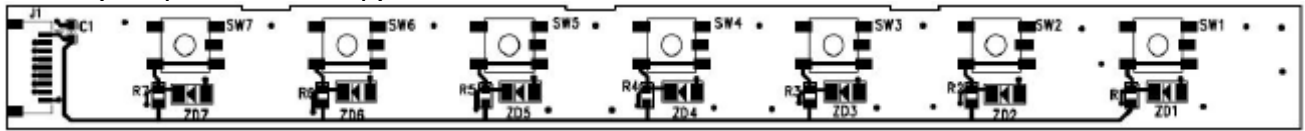

Keypad Board (Component Side Bottom)



IR/LED Board (Component Side Top)

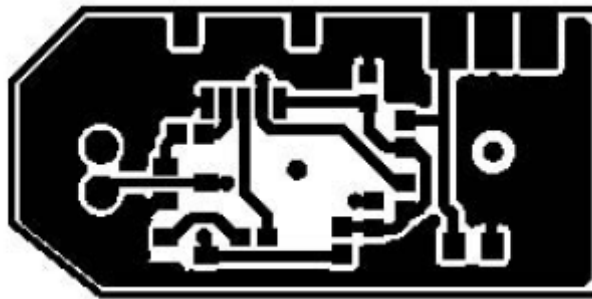

AUX AV Board (Component Side Top)

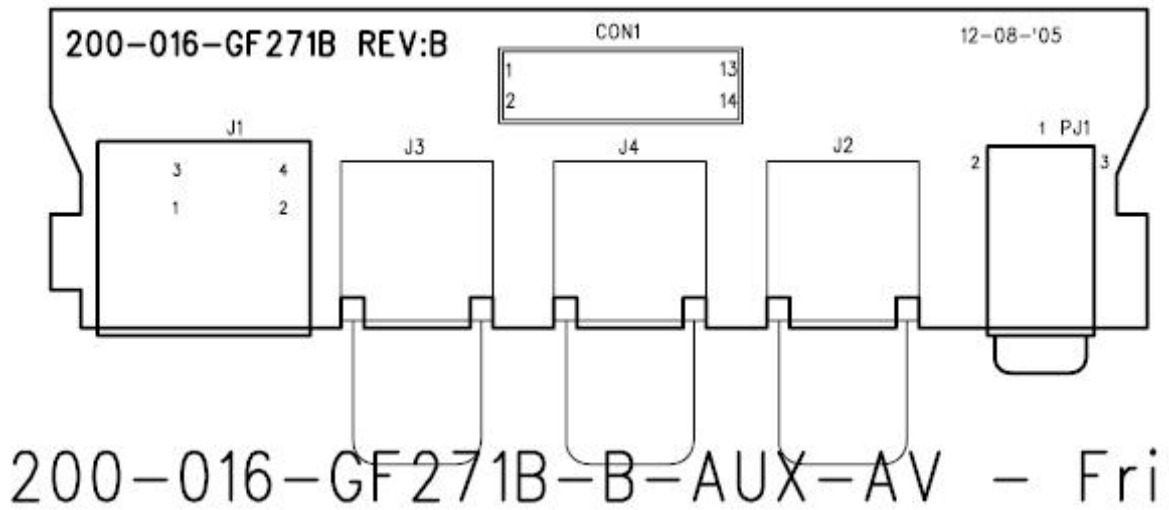

D-SUB 37 Pin Board (Component Side Top)

