



**Read the
separate
safety
manual
before
installing,
operating,
or servicing**

Published Manual Number: MTCJXR01

- Specified Date: 20070531
- As-of Date: 20070531
- Access Date: 20070531
- Custom: n/a
- Applicability: CJX
- Language Code: ENG01, Purpose: publication, Format: 1colA

Technical Reference— Operating, Programming, and Troubleshooting the E-P Express[®] Controller

Applicable Milnor® products by model number:

30010G5X 30015G5X 30015T5X 30022T5X MWR18X4-

Preface

BICJXK01 (Published) Book specs- Dates: 20070531 / 20070531 / 20070531 Lang: ENG01 Applic: CJX

i. About this Manual

i. 1. Scope

This manual provides commissioning, programming, operating, and troubleshooting instructions for Milnor® washer-extractors using the E-P Express® microprocessor control system. See the installation manual for information on machine installation procedures and mechanical requirements. See the service manual for preventive maintenance, service procedures, and mechanical parts identification. See the schematic manual for electrical parts identification and electrical troubleshooting instructions.

i. 2. Best Available Information [Document BIUUUD17]

This manual contains the most accurate and complete information available when Milnor shipped your machine/software. Products are occasionally released with the best available documentation, even though the device identification (model numbers, etc.) on the documentation does not explicitly include the delivered model. In such cases, use the documentation provided.

Although unlikely, incorrect manuals may have shipped with your machine. If you believe you received the wrong manuals, or if you need specific information about any aspect of your machine not addressed in the provided documentation, contact the Milnor Customer Service group.

i. 3. The Normal Display at Start-up

The start-up display sequence for E-P Express® machines is described in document BICJHO01, entitled “Running a Formula.” Use the table of contents for this manual to locate this document.

i. 4. How to Identify this Manual and its Included Documents [Document BIUUUD13]

A complete identification of this manual or any document in this manual must include **all** specifications shown on the front cover, as defined below:

Published manual number—Primary identification number for the manual or any variation of it.

Specified date—The approximate date of introduction of the product or product change this manual covers.

As-of date—When a manual for an old product is generated, any new information about the old product developed up to this date will be included in the manual.

Access date—The date the manual was generated (assembled and formatted).

Applicability—Code(s) that represent a group of machines this manual applies to and/or actual model numbers of applicable machines. The complete list of applicable models is provided inside the front cover. If “not used” appears here, this is not a product manual, but has another purpose such as to provide administrative procedures.

Language Code—A code representing the specific language and dialect of this manual. “Eng01” identifies the language/dialect of the manual as United States English.

When referring to any **document** used in this manual (as identified by an eight-character document number such as BIUUUD13 at the start of the document), a complete identification of the document must include all specifications shown on the front cover, except substituting the document number for the published manual number.

i. 5. Trademarks [Document BIUUUD14]

i. 5.1. Trademarks of Pellerin Milnor Corporation—The following terms, some of which may be used in this publication, are trademarks of Pellerin Milnor Corporation:

Table 1: Trademarks

CBW®	E-P OneTouch®	Mentor®	Milnet®	Staph-Guard®
E-P Express®	E-P Plus®	Mildata®	Milnor®	Visionex™
	Gear Guardian®		MultiTrac™	

i. 5.2. Trademarks of Other Companies—The following terms, some of which may be used in this publication, are trademarks of their respective companies:

Table 2: Trademarks

Acronis®	IBM®	Microsoft Office XP®	Microsoft Access®	Siemens®
Atlas 2000®	Microsoft Windows 2000®	Microsoft Windows NT®	Microsoft Windows XP®	Seagate Crystal Reports®
		Yaskawa®		

— End of BICJXK01 —

Table of Contents

Sections	Figures, Tables, and Supplements
Preface	
i. About this Manual (Document BICJXK01)	
i.1. Scope	
i.2. Best Available Information (Document BIUUUD17)	
i.3. The Normal Display at Start-up	
i.4. How to Identify this Manual and its Included Documents (Document BIUUUD13)	
i.5. Trademarks (Document BIUUUD14)	
i.5.1. Trademarks of Pellerin Milnor Corporation	Table 1: Trademarks
i.5.2. Trademarks of Other Companies	Table 2: Trademarks
Table of Contents	
Chapter 1. Commissioning	
1.1. Important Owner/User Information (Document BIRHUK01)	
1.1.1. Ensure Safety of All Laundry Personnel	
1.1.2. Customize Data	
1.1.2.1. When to Customize Data	
1.1.2.2. What Customizing Requires	
1.1.2.3. Data Accessibility	Table 3: Data Use and Alteration
1.1.2.4. If Data Becomes Corrupted	
1.2. About the Forces Transmitted by Washer-extractors (Document BIWUUI02)	
1.2.1. Foundation Considerations	
1.2.2. How Strong and Rigid?	Figure 1: How Rotating Forces Act on the Foundation Figure 2: How Rotating Forces Act on the Foundation
1.3. Important Instructions for Pumped Chemical Inlets (Document BIWUUI01)	
1.3.1. How Pumped Chemical Systems can Internally Damage the Washer-extractor	Supplement 1: Preventing Dribbling by Purging Chemical Lines
1.3.2. Locating Chemical System Components to Reduce the Risk of Internal Damage	Figure 3: Proper Routing of Chemical Tubing
1.3.3. Preventing Leaks Which Can Injure Personnel and Cause External Damage	Figure 4: Rear-mounted Water and Liquid Supply Injector
1.4. Electrical Connections for Liquid Chemical Systems (Document BICEUI01)	
	Supplement 2: Maximizing Chemical Injection Precision

Sections	Figures, Tables, and Supplements
1.4.1. Pump Signal Connections	Table 4: Chemical Injection Signals
1.4.2. <i>Timer Stop</i> Connections	Figure 5: Pump Signal Connections Figure 6: <i>Timer Stop</i> Connections
Chapter 2. Programming	
2.1. Controls on E-P Express® Washer-extractors (Document BICJHC01)	Figure 7: E-P Express Control Panel
2.1.1. Control Functions During Normal Operation	
2.1.2. Control Functions During Manual Operation	
2.1.3. Control Functions During Programming	
2.2. Selecting an Industry Formula Set (Document BICJHC02)	Figure 8: Location of DIP Switches Table 5: DIP Switch Settings for Industry Configurations
2.3. Programming the E-P Express® Control (Document BICJXP01)	
2.3.1. How to Avoid Data Loss	
2.3.2. How to Return to Run Mode	
2.3.3. How to Add or Change a Formula	
2.3.3.1. Quick Reference for E-P Express Programming	
2.3.3.2. Moving through the Operations and Decisions	
2.3.3.3. How to Create a New Formula	
2.3.3.4. How to Delete a Formula	
2.3.3.5. How to Change a Formula	
2.3.3.5.1. How to Insert or Delete a Step in an Existing Formula	
2.3.3.5.2. Inserting a Step	
2.3.3.5.3. Deleting a Step	
2.3.3.5.4. How to Save Changes	
2.3.3.6. The Step Decisions	
2.3.3.6.1. TT = Step Type	
2.3.3.6.2. MMQ = Step Time	Table 6: Summary of Step Types
2.3.3.6.3. C = Chemicals	Table 7: Chemical Signals and Supplies
2.3.4. How to Configure the Controller	
2.3.4.1. Moving through the Configure Screens	
2.3.4.2. The Configure Decisions	Supplement 3: About Chemical Injection with the E-P Express Controller
2.3.5. Restoring the Standard Formulas (Document BICJUP01)	Figure 9: Procedure for Restoring Standard Formulas
2.3.6. Data Transfer (Option 4) (Document BICJUP13)	Table 8: Controllers Capable of Transferring Memory Figure 10: Controls Identification on Serial Memory Storage Device

Sections	Figures, Tables, and Supplements
2.3.6.1. Establishing the Required Connections	
2.3.6.2. Saving Data from the Machine to the Storage Device or a Second Machine	
2.3.6.3. Restoring Saved Data to the Machine from the Storage Device or Another Machine	

Chapter 3. Operating

3.1. Running a Formula (Document BICJHO01)

- 3.1.1. Applying Power
- 3.1.2. Selecting and Starting the Formula
 - 3.1.2.1. Load Machine and Close Door
 - 3.1.2.2. Selecting a Formula
- 3.1.3. Unloading the Machine
- 3.1.4. The Display During Automatic Operation
- 3.1.5. How to Shorten, Terminate, or Suspend a Running Formula
- 3.1.6. How to Restart after Power Loss
- 3.1.7. How the Flush Valve Works

3.2. Viewing and Clearing the Formula Count Accumulator (Document BICJUD01)

Chapter 4. Testing and Troubleshooting

4.1. Error Messages (Document BICJHT01)

- 4.1.1. Error Messages at Power Up
- 4.1.2. Error Messages during Normal Operation

4.2. The E-P Express® Manual Menu (Document BICJHT03)

- 4.2.1. The *Manual Menu*
 - 4.2.1.1. Components
 - 4.2.1.2. How to Access the *Manual Menu*
 - 4.2.1.3. How to Return to the *Run Mode* from the *Manual Menu*
- 4.2.2. Determining the Software Version
- 4.2.3. Viewing Microprocessor Inputs
- 4.2.4. Actuating Microprocessor Outputs
- 4.2.5. Testing and Verifying the DIP Switch Settings
- 4.2.6. Viewing Inputs and Outputs while Machine is Operating

Table 9: E-P Express Inputs

Table 10: E-P Express Outputs

Figure 11: Processor Board

Table 11: Interpretation of *Test DIP Switch* Display

Chapter 5. Supplemental Information

5.1. The E-P Express® Hardware (Document BICJUF01)

- 5.1.1. Keyswitches

Sections	Figures, Tables, and Supplements
5.1.1.1. Run/Program Keyswitch	
5.1.1.2. Automatic/Test Keyswitch	
5.1.2. Display	
5.1.3. Power Supply	
5.1.4. CPU Processor Board	
5.1.5. Outputs	
5.1.6. Option Outputs	
5.1.7. Analog to Digital Convertor	
5.1.8. Temperature Probe	
5.1.9. Pressure Sensor	
5.2. Serial Memory Storage Device Applications (Document BICUDC01)	Figure 12: Serial Memory Storage Device Figure 13: Rear View of Circuit Board Table 12: DIP Switch Positions for Use with E-P Plus and E-P Express Machines (External Transmit Button Required)
5.3. Construction of External Serial Link Cables (Document BICWUC01)	
5.3.1. Pin Identification	Figure 14: 9-Pin DIN Connector Pin Identification (from wire entry side of connectors) Table 13: External Serial Link Pin Assignments
5.3.2. How to Wire the Cables	
5.3.2.1. Cable Specifications	
5.3.2.2. Connecting Two or More Machines for Machine-to-machine Transfer	Figure 15: Wiring Diagram for Cable to Connect Two or More Machines
5.3.2.3. Connecting a Machine to a Serial Memory Storage Device	Figure 16: Wiring Diagram for Cable to Connect a Machine to a Serial Memory Storage Device

Chapter 1

Commissioning

BIRHUK01 (Published) Book specs- Dates: 20070531 / 20070531 / 20070531 Lang: ENG01 Applic: CJX

1.1. Important Owner/User Information

The following two procedures must be completed before this machine is placed in service:

1. Ensure the safety of all laundry personnel.
2. Customize the data contained in the memory of the machine (configuration, formulas, and productivity/formula accumulator data).

1.1.1. Ensure Safety of All Laundry Personnel

Ensure that all personnel who will operate or maintain this machine read the safety manual before permitting them to access the machine. Ensure that all user manuals are available to the appropriate personnel and that all precautions explained in all applicable manuals are observed.

1.1.2. Customize Data

Customizing the data includes verifying that the controller is configured for the particular application, modifying certain wash programs if necessary for optimum productivity, and verifying that the formula count accumulator is cleared so the formula count will be accurate.

1.1.2.1. When to Customize Data

- When commissioning the machine
- When required by error message
- After replacing the microprocessor board
- After upgrading the software
- After adding or removing optional equipment

1.1.2.2. What Customizing Requires—Verify configuration. Program formulas and clear productivity data, if applicable. See the programming and operating sections in this manual for instructions.

1.1.2.3. Data Accessibility—Configuration and formula data can only be altered while the keyswitch is in the *Program* position (data is protected by the keyswitch). Productivity data, because it is accumulated in the *Run* mode, cannot be protected by the keyswitch and is accessible to anyone. Data is accessible to the extent described in [Table 3](#).

Table 3: Data Use and Alteration

Data Type	How Data can be Used and Altered
Configuration Data	Data can be read and written over
Formula Data	Data can be read, written over (added to/changed) and cleared
Productivity Data	Data can be read and cleared

1.1.2.4. If Data Becomes Corrupted—If the microprocessor senses that data is unusable or unreliable, an error message will appear—usually at power-up—possibly preventing machine operation. The consequences and appropriate actions for each error message are explained in the troubleshooting instructions. Follow these instructions exactly to ensure that corrupt data is completely eliminated and replaced with valid data. Failure to do so may result in unsafe operation or machine damage.

— End of BIRHUK01 —

BIWUUI02 (Published) Book specs- Dates: 20070531 / 20070531 / 20070531 Lang: ENG01 Applic: CJX

1.2. About the Forces Transmitted by Washer-extractors

During washing and extracting, all washer-extractors transmit both static and dynamic (cyclic) forces to the floor, foundation, or any other supporting structure. During washing, the impact of the goods as they drop imparts forces which are quite difficult to quantify. Size for size, both rigid and flexibly-mounted machines transmit approximately the same forces during washing. During extracting, rigid machines transmit forces up to 30 times greater than equivalent flexibly-mounted models. The actual magnitude of these forces vary according to several factors:

- machine size,
- final extraction speed,
- amount, condition, and type of goods being processed,
- the liquor level and chemical conditions in the bath preceding extraction, and
- other miscellaneous factors.

Estimates of the maximum force normally encountered are available for each model and size upon request. Floor or foundation sizes shown on any Milnor® document are only for on-grade situations based only on previous experience without implying any warranty, obligation, or responsibility on our part.

1.2.1. Foundation Considerations

Size for size, rigid washer-extractors naturally require a stronger, more rigid floor, foundation, or other supporting structure than flexibly-mounted models. If the supporting soil under the slab is itself strong and rigid enough and has not subsided to leave the floor slab suspended without support, on grade installations can often be made directly to an existing floor slab if it has enough strength and rigidity to safely withstand our published forces without transmitting undue vibration. If the subsoil has subsided, or if the floor slab itself has insufficient strength and rigidity, a deeper foundation, poured as to become monolithic with the floor slab, may be required. Support pilings may even be required if the subsoil itself is “springy” (i.e., if its resonant frequency is near the operating speed of the machine). Above-grade installations of rigid machines also require a sufficiently strong and rigid floor or other supporting structure as described below.

1.2.2. How Strong and Rigid?

Many building codes in the U.S.A. specify that laundry floors must have a minimum live load capacity of 150 pounds per square foot (732 kilograms per square meter). However, even

compliance with this or any other standard does not necessarily guarantee sufficient rigidity. In any event, it is the sole responsibility of the owner/user to assure that the floor and/or any other supporting structure exceeds not only all applicable building codes, but also that the floor and/or any other supporting structure for each washer-extractor or group of washer-extractors actually has sufficient strength and rigidity, plus a reasonable factor of safety for both, to support the weight of all the fully loaded machine(s) including the weight of the water and goods, and including the published 360-degree rotating sinusoidal RMS forces that are transmitted by the machine(s). Moreover, the floor, foundation, or other supporting structure must have sufficient rigidity (i.e., a natural or resonant frequency many times greater than the machine speed with a reasonable factor of safety); otherwise, the mentioned 360-degree rotating sinusoidal RMS forces can be multiplied and magnified many times. It is especially important to consider all potential vibration problems that might occur due to all possible combinations of forcing frequencies (rotating speeds) of the machine(s) compared to the natural frequencies of the floor and/or any other supporting structure(s). A qualified soil and/or structural engineer must be engaged for this purpose.

Figure 1: How Rotating Forces Act on the Foundation

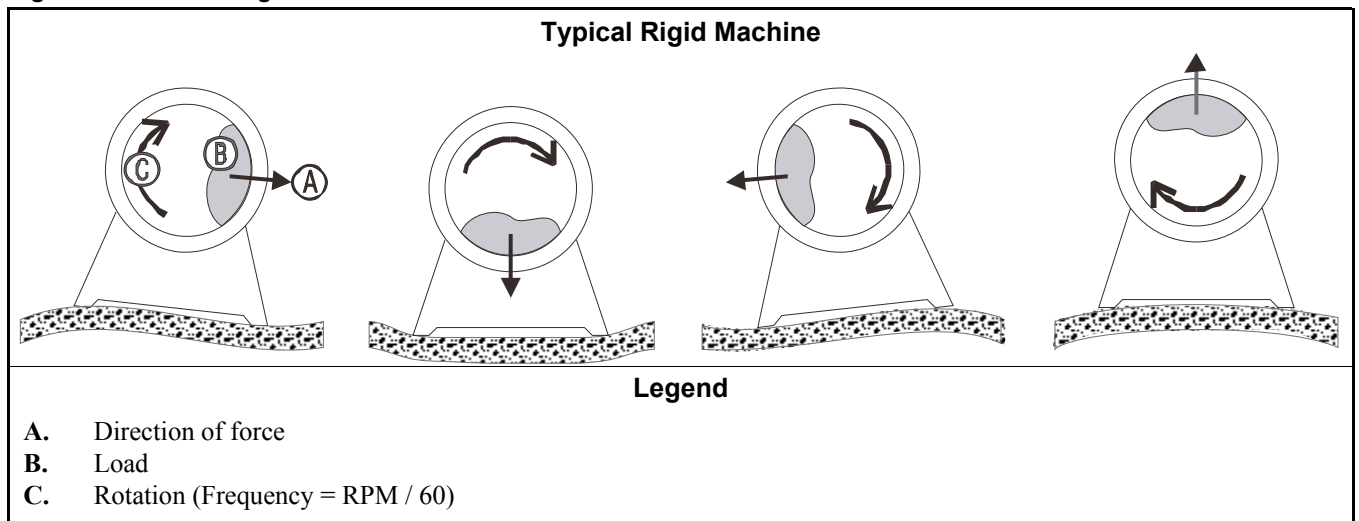
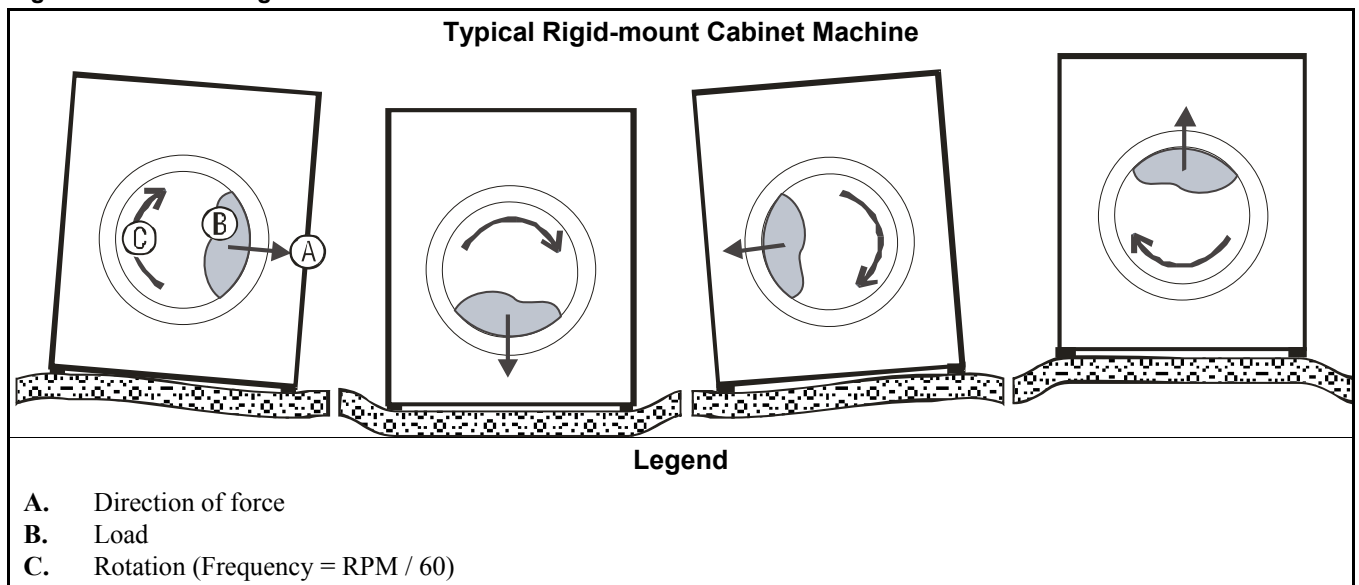

Figure 2: How Rotating Forces Act on the Foundation



The figure(s) above depict(s) both on-grade and above-grade installations as well as models installed directly on a floor slab or on a foundation poured integrally with the slab. Current machine data is available from Milnor® upon request. All data is subject to change without notice and may have changed since last printed. It is the sole responsibility of every potential owner to obtain written confirmation that any data furnished by Milnor® applies for the model(s) and serial number(s) of the specific machines.

— End of BIWUUI02 —

BIWUUI01 (Published) Book specs- Dates: 20070531 / 20070531 / 20070531 Lang: ENG01 Applic: CJX

1.3. Important Instructions for Pumped Chemical Inlets

1.3.1. How Pumped Chemical Systems can Internally Damage the Washer-extractor

Many pumped liquid chemical systems dribble concentrated chemicals out of the injection tubes when the system is not used for relatively long periods of time—as after working hours and during weekends. This puts highly concentrated corrosive chemicals in direct contact with dry stainless steel surfaces, and often directly on any textiles left in the machine. **Chemical deterioration (rusting) of the stainless steel and damage to the textiles is the inevitable result.**

PELLERIN MILNOR CORPORATION accepts absolutely no responsibility whatsoever for damage to its equipment or to any textiles therein when concentrated chemicals dribble out of the injection tubes onto any part of the machine or its contents.

Supplement 1

Preventing Dribbling by Purging Chemical Lines

Although the injection site is flushed by washer agitation on some models and after each injection on other models to aid the injection process, this flushing provides absolutely no protection against harmful dribble which occurs later—when the machine is no longer in use.

One foolproof solution for “dribbling” is to completely purge the appropriate chemical injection tube with fresh water after every injection, so that only fresh water (which cannot cause a problem) can dribble out.

Obviously, it is the sole responsibility of the pump and/or chemical supplier (not the machine manufacturer) to furnish such a flushing device. (We understand that such flushing type chemical injection systems—both for retrofit to existing systems and for new installations—are now offered by others.)

1.3.2. Locating Chemical System Components to Reduce the Risk of Internal Damage

If the tubes, pumps, and chemical tanks are kept well below the injection point, the likelihood of “after-hours dribbling” is reduced, but not totally eliminated.

We therefore urge that tubes from any non-flushing pumped chemical system be connected as shown in [Figure 3](#). Although fresh-water flushing the just-used tubes after each injection would be better, we believe routing the tubes as indicated will probably minimize the dribbling effect about as much as possible without flushing. Never permit tanks, pumps, or any portion of the tubes to be higher than the injection point. If loops in the injection tubes are employed, make sure the entire loop is well below the injection point.

Figure 3: Proper Routing of Chemical Tubing

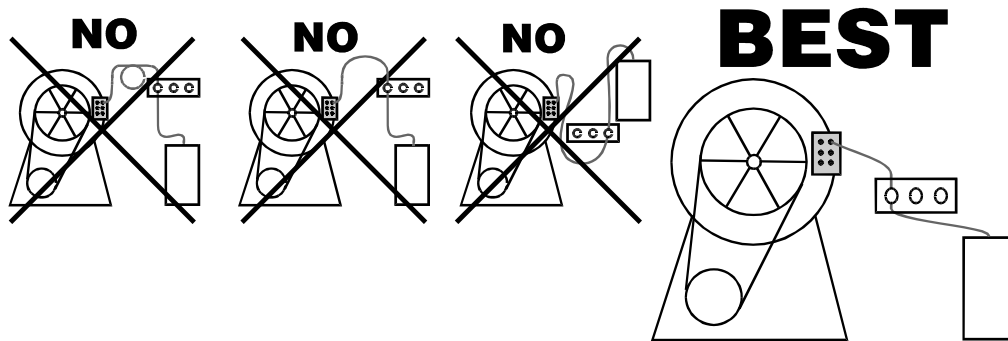

Note 1: As shown in Figure 3, all tanks, pumps, and tubing must be lower than the injection point on the machine and must not dribble chemicals into the machine, nor leak chemicals externally onto any portion of the machine or its surroundings.

1.3.3. Preventing Leaks Which Can Injure Personnel and Cause External Damage

Any ports on the inlet are plugged at the Milnor® factory. When replacing plugs with fittings or when reinstalling plugs, always use the sealant furnished (LocTite® RTV Silicone Adhesive or equivalent). Use properly sized hose barbs, always use clamps, and check for leaks. Use the hose barbs furnished with your machine only if they provide the proper fit for the tubes employed. Ensure that excessive pressures cannot build up that might burst or disconnect tubing. Instruct the operator to monitor for leaks and report any occurrences.

When calibrating injections, it is permissible to remove tubes from barbed fittings to take samples. However, always check for leaks after installing tubes and clamps. A preferable method for sampling is to install a three-way valve, or two two-way valves and a tee fitting, onto each injection tube.



WARNING 1: Avoid chemical burns and corrosion—Concentrated liquid chemicals leaking from a chemical system can burn skin and eyes, cause other types of injury or illness, and corrode machine components.

- Ensure that excessive pressures cannot build up which might burst or disconnect a chemical delivery tube.
- Ensure that there are no external chemical leaks when the system is installed or calibrated.
- Periodically check the system for leaks during operation.



CAUTION 2: Avoid corrosion and textile damage—Chemicals dribbling into the machine when it is idle will corrode machine components and damage any textiles left in the machine.

- If possible, use a system that flushes the entire chemical delivery tube after each injection.
- If a non-flushing system is used, install tanks, pumps, and tubing below the injection point on the machine, such that chemicals travel to the machine at an upward angle.



CAUTION 3: Avoid explosions—Certain chemicals will react chemically when combined. Consult with your chemical supplier representative about the safe use of chemicals.

Figure 4: Rear-mounted Water and Liquid Supply Injector

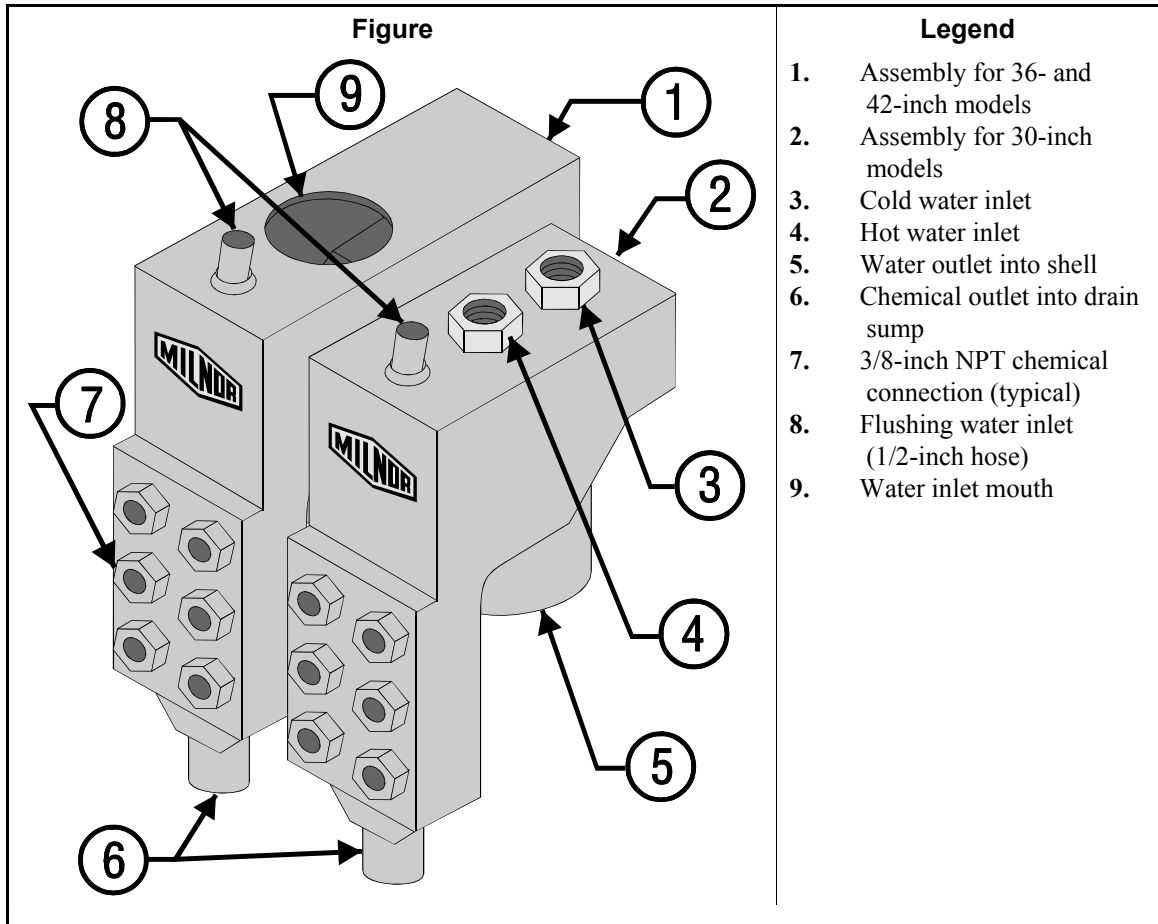

Notice 4: Pellerin Milnor Corporation accepts absolutely no responsibility for damage to its equipment or to any textiles therein when concentrated chemicals dribble out of the injection tubes onto any part of the machine or its contents.

— End of BIWUUI01 —

BICEUI01 (Published) Book specs- Dates: 20070531 / 20070531 / 20070531 Lang: ENG01 Applic: CJX

1.4. Electrical Connections for Liquid Chemical Systems



WARNING 5: Electric Shock Hazard—Contact with high voltage electricity will kill or seriously injure you. Even when the machine is not running, three-phase power and control circuit power are still present at several locations within the cabinet and at some electrical components.



CAUTION 6: Injury and Damage Hazards—Improper wiring can cause the machine to malfunction, risking injury to personnel, damage to machine components, and damage to goods.

- Electrical and piping connections described in this section must be made only by qualified, authorized personnel.
- Lock off and tag out power at the external disconnect switches for the washer-extractor before proceeding.
- Do not rely merely on the information in this section when wiring. Consult all applicable electrical schematics.
- Do not reroute or rearrange any wires not specifically permitted by this instruction.

- Do not connect a common wire to ground. Use the common terminal furnished.



CAUTION [7]: Risk of Poor or Inconsistent Wash Quality—Injection times of less than 10 seconds are discouraged because fine adjustments are not possible, and factors such as pump lag time may cause significant variations in the amount of chemical delivered.

- Size pumps or valves small enough for adequate control (i.e., for longer injection times).
- Use two pumps or valves to inject a small or large quantity of the same chemical, if required.

Supplement 2

Maximizing Chemical Injection Precision

Injection of a consistent amount of chemical is important in controlling wash quality and using chemicals economically. When chemicals are injected by units of time, as is done with most washer-extractors, injections of short duration can be imprecise because of two reasons:

- Fine adjustments to the delivered quantity are not possible. For example, if an injection of three seconds is extended by one second, the quantity delivered is theoretically increased by more than 30 percent. However, if an injection of 20 seconds is increased by one second, the theoretical quantity is increased by only five percent.
- Variations in the time between the start of the chemical signal and the start of the chemical delivery into the machine can cause significant differences in the quantity of chemical injected. In this case, if a pump starts more slowly some times than others, or if the delivery tubes are partially empty at the start of the inject period, the quantity of chemical delivered may vary significantly. As an example, assume a peristaltic pump moves chemical along the delivery tube at a rate of three feet per second. If the delivery tube is empty for three feet along its length, then one second of the injection time is spent injecting air rather than chemical. If the programmed injection time is only three seconds, then one third of the desired chemical is not being delivered. However, if the programmed injection time is 20 seconds, the chemical delivery is only five percent less than desired.

Increasing the programmed injection time makes any variation less significant. Use pumps and/or valves sized to allow inject times of at least 10 seconds. If injection times for a specific chemical vary widely from one formula to another, consider using two pumps or valves for the same chemical. Actuate one pump for injecting small quantities, and use both pumps or valves for larger quantities.

1.4.1. Pump Signal Connections

The E-P Express[®] controller closes certain relay contacts when chemicals are desired and to flush the chemical system after each injection. These signals are alternating current at the control circuit voltage and cannot be made potential-free. Any device driven by this signal can draw up to 37 milliamperes.

Note 2: The manifold flush signal is effective only if the chemical supply system provided by others is properly designed and connected to a flushing water source.



CAUTION [8]: Component Damage Hazard—Board components will burn out and require board replacement if devices driven by inject signals do not meet the above electrical specifications. Pumps usually draw a higher current than specified above, and will cause board damage.

This machine provides signals for five chemicals and a manifold flush. [Table 4](#) contains the connection details for these signals. All chemical signal connections are available on terminal strip

TBS, as shown in Figure 5. This terminal strip is located in the electrical enclosure on the left rear of the machine, where the machine power connections are made.

Table 4: Chemical Injection Signals

Signal Component	Chemical	Relay	Processor Board Connection	TBS Terminal Number
Chemical 1	Detergent	K2	M5-3, 1	1
Chemical 2	Bleach	K5	M5-6, 1	2
Chemical 3	Sour	K4	M5-5, 1	3
Chemical 4	Softener	K3	M5-4, 1	4
Chemical 5	Starch	K1	M5-2, 1	5
Manifold Flush	none	K9	M3-5, 1	6

Figure 5: Pump Signal Connections

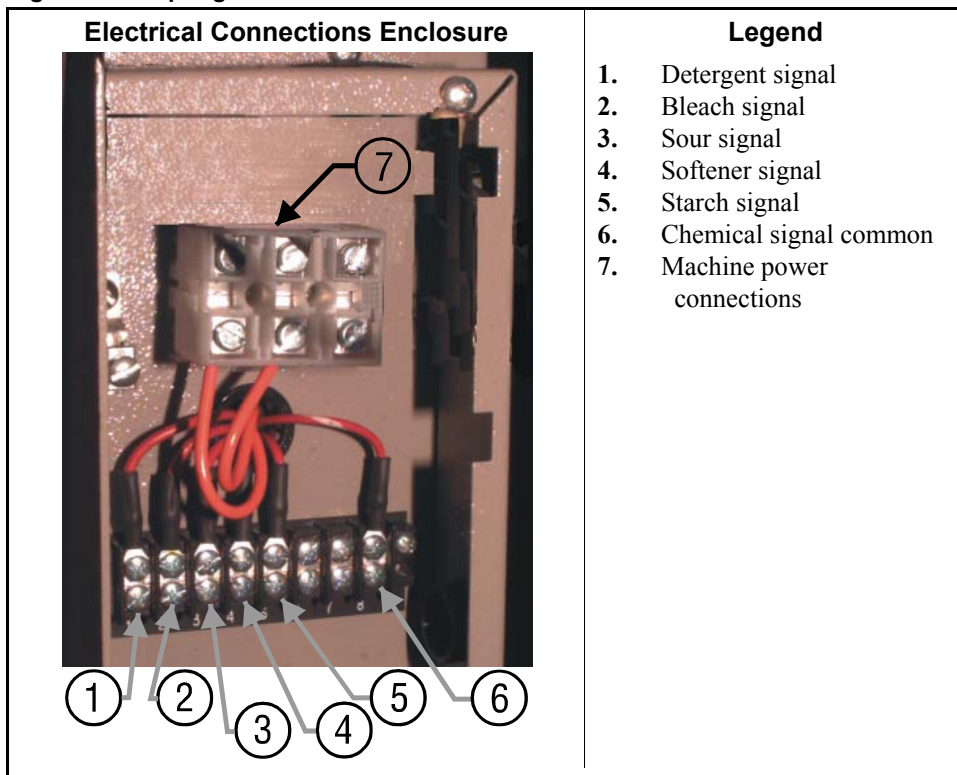

1.4.2. **Timer Stop Connections**

This feature is not available on coin-operated machines. *Timer stop* is a feature of the E-P Express control which stops the machine timer while a certain input to the microprocessor is grounded. When multiple machines without this feature are connected to a common chemical supply system, the quantity of chemical injected can vary widely if two or more machines request chemical simultaneously. When timer stop is properly wired with the chemical supply system, the supply system stops the timers in certain linked machines when one machine requests chemical. When the chemical injection is completed, the chemical supply system terminates the *timer stop* command, and the stopped timers resume counting.

When the timer in a machine is stopped, the current formula event continues until the timer resumes counting. If water valves are open when the timer stops, they will close when the desired level is reached. Chemical injection signals will stop after the designated time, but the manifold flush signal will not occur until the timer starts. All other actions (cylinder reversing, extract speed, drain speed, etc.) that are in progress when the timer is stopped will continue until the timer starts again and the programmed time for the current event expires.

Milnor provides two wires terminated with butt connectors in the rear console of the machine, as shown in [Figure 6](#). One wire originates electrically from pin 6 of M5 on the processor board. The other wire is electrically identical to pin 16 of M6 on the processor board. For *timer stop* to operate, the chemical system should include a normally open contact between these two connectors. When the contact is open, the machine runs normally. When the contact is closed, the machine timer stops until the contact opens again.

Figure 6: Timer Stop Connections

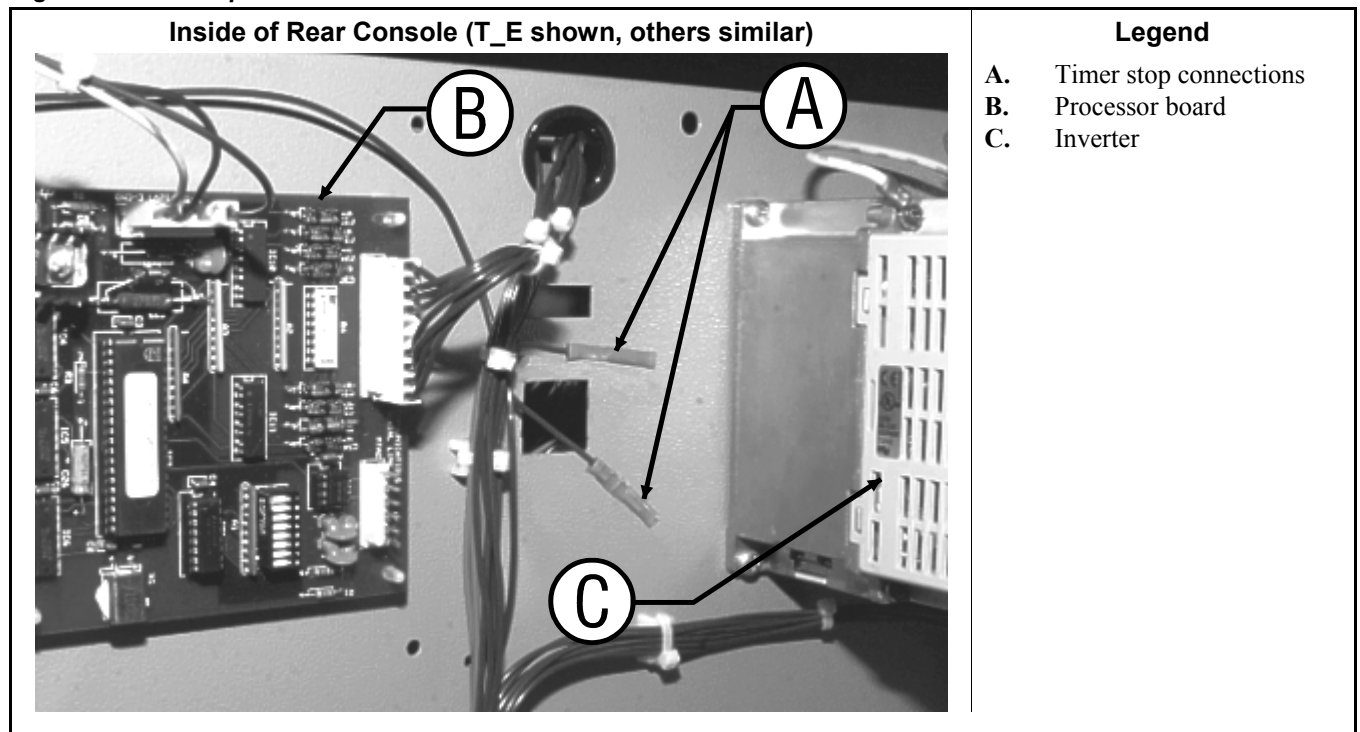

— End of BICEUI01 —

Chapter 2

Programming

BICJHC01 (Published) Book specs- Dates: 20070531 / 20070531 / 20070531 Lang: ENG01 Applic: CJX

2.1. Controls on E-P Express® Washer-extractors

The controls on these Milnor® washer-extractors are predominantly membrane push-buttons, some of which include indicator lights. Other controls include a keyswitch and a mechanical button to unlatch the door. Some of these controls serve different functions in the three operational modes of the machine. The function of each control in the normal, manual, and programming modes of this machine is described in detail in this document.

Figure 7: E-P Express Control Panel

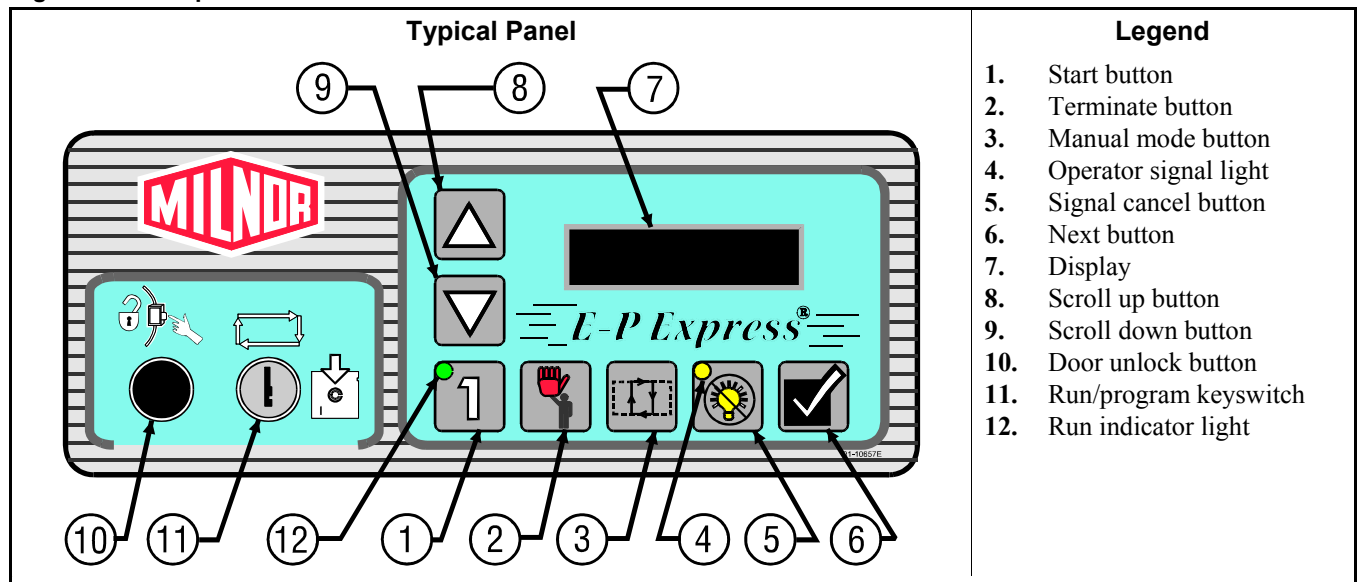

2.1.1. Control Functions During Normal Operation

Normal operation is the state of the machine when the machine control circuit is energized. The machine may be either idle (waiting to run a formula) or running. If the machine is idle, the message on the display will begin with "Run Formula" and include a formula number on the second line.

1. Press the *Start* button (1) to initiate the selected wash formula. The formula begins if power is available at the machine and the loading door is closed. When the *Start* button is held depressed while the *Scroll Up* button is pressed, the machine displays the status of the microprocessor inputs for troubleshooting.

2. The *Terminate* button (⏏) cancels all remaining steps in any running formula and initiates the shutdown procedure for the machine. Formulas ended in this manner cannot be resumed.
3. The *Manual mode* button (⏏) has no effect while a formula is running. Pressing this button when the display says “Run Formula xx” initiates manual mode, where the controls function as described in [Section 2.1.2 “Control Functions During Manual Operation”](#).
4. The *Operator signal* light, in the upper left corner of the *Signal cancel* button (⏏), is a visual indicator that operator attention is required. This light is illuminated simultaneously with the sounding of the operator signal buzzer.
5. Press the *Signal cancel* button (⏏) to silence the operator signal buzzer which sounds when a formula completes normally. Also, if a signal is programmed with a chemical injection in any formula, this button must be pressed to indicate that the chemical has been added and to resume operation.
6. The *Next* button (⏏) is not used during normal operation.
7. The display on these machines is a vacuum fluorescent type displaying two lines of twenty characters each.
8. The *Scroll up* button (⏏) functions in much the same manner as the *Scroll down* button described above. Press this button to display the next higher numbered formula in memory. For troubleshooting, hold the *Manual* button and press the *Scroll up* button to view the status of the first 12 outputs. Hold the *Start* button and press the *Scroll up* button to view the status of the microprocessor inputs.
9. When selecting a specific formula to run, press the *Scroll Down* button (⏏) to display the next lower numbered formula in memory. Press this button with the lowest formula displayed (Formula 01) to select the highest numbered available formula (maximum of 30 formulas). For troubleshooting, hold the *Manual* button and press the *Scroll Down* button to view the status of the second 12 outputs.
10. The *Door unlock* button (⏏) releases the door lock, allowing the latch on the door to operate. Hold this button depressed and press firmly on the door latch lever to open the door for load and unloading.
11. The *Run/program* keyswitch must be in the *Run* position (⏏) unless the machine is being configured or programmed. All control descriptions listed under [Section 2.1.1 “Control Functions During Normal Operation”](#) are based on the keyswitch being in the *Run* position. Refer to [Section 2.1.3](#) for descriptions of how the controls operate with the keyswitch in the *Program* position (⏏).
12. The *Run Indicator* light, in the upper left corner of the *Start* button, is illuminated when a formula is started by pressing ⏏. If the operator terminates the formula before it runs to completion (with ⏏), the light goes off when any coast time expires and the door is unlocked. If the formula runs to completion, the light goes off when the coast time following the final extract step expires.

2.1.2. Control Functions During Manual Operation

Manual operation is used primarily for troubleshooting the machine by activating outputs and viewing inputs.

1. The *Start* button (⏏), when pressed while the *Manual* button is held down, activates the selected menu function. Depress the *Start* and *Manual* buttons simultaneously to view the software date code. For other manual menus, release the *Start* button when the menu appears on the display.
2. The *Terminate* button (⏏) cancels manual mode and returns the controller to the normal operation or programming mode, depending on the setting of the *Run/Program* keyswitch. Any outputs that were manually actuated while in manual mode are turned off.

3. Use the *Manual* button (M) to enter manual mode when the machine is idle.
4. The *Operator Signal* light does not operate when the controller is in manual mode.
5. The *Signal Cancel* button (SC) has no function in manual mode.
6. The *Next* button (N) has no function in manual mode.
7. In the *Manual menu*, the display presents user prompts and selected information. The software date code and machine configuration are displayed; inputs and outputs and their respective statuses are shown in those modes. Other menu selections display DIP switch settings, as well as temperature and level testing information.
8. The *Scroll Up* button (▲) displays the next higher numbered mode in the manual menu. For example, pressing this button once will scroll from the *Software Date Code* mode to the *Test Inputs* mode.
9. At the manual menu, the *Scroll Down* button (▼) displays the available menu items in reverse numeric order.
10. The *Door unlock* button (D) unlocks the door latch. The function of this button is the same whether the machine is in normal operating mode or manual mode.
11. The *Run/Program* keyswitch has no effect on how the manual mode operates. However, the status of the switch (either + or -) is displayed in field F in the *Test Inputs* menu.
12. The *Run Indicator* light is not activated during manual operation.

2.1.3. Control Functions During Programming

The programming mode is used to modify the actions performed in a wash formula or to create new wash formulas.

1. The *Start* button (S) is used in combination with the *Next* button (N) or the *Terminate* button (T) to delete or insert a step in a wash formula, respectively.
2. The *Terminate* button (T) returns the user to the main programming menu (top line of display reads *Program X Menu*) from the *Add/Change Formula* and the *Standard Formulas* menus. The *Terminate* button has no effect after the *Configure menu* has been accessed, or after any parameter of any formula has been accessed in the *Add/Change Formula menu*.
3. The *Manual* button is not used in the programming mode.
4. The *Operator Signal* light is not used in the programming mode.
5. The *Signal Cancel* button is not used in programming.
6. Use the *Next* button (N) to confirm any choice and move to the next decision in the sequence.
7. The display presents the programming menus and choices within those menus, including all configuration and formula parameters.
8. The *Scroll Up* button (▲) scrolls the available choices upward from the lowest available number.
9. Use the *Scroll Down* button (▼) to change the selected programming parameter to the next lower-numbered choice.
10. The *Door unlock* button (D) has no function in programming mode.
11. The *Run/Program* keyswitch allows programming when set to P. The *Program* menu includes selections for adding and changing wash formulas, configuring the controller, and restoring the standard formulas provided with the machine. The keyswitch must be set to the *Run* position (R) for normal machine operation, as described in [Section 2.1.1 “Control Functions During Normal Operation”](#).

12. The *Run Indicator* light is not actuated during programming.

— End of BICJHC01 —

BICJHC02 (Published) Book specs- Dates: 20070531 / 20070531 / 20070531 Lang: ENG01 Applic: CJX

2.2. Selecting an Industry Formula Set

The Milnor[®] factory configures each E-P Express[®] washer-extractor controller for the industry specified by the purchaser when the machine is ordered. The configuration process consists of setting the DIP switches on the processor board and may include installing the appropriate industry nameplate on some models. At the owner's discretion, the DIP switch settings controlling the available formulas may be changed in the field, and new industry nameplates may be obtained from your dealer or the Milnor[®] parts department.

To change industry configuration, turn the machine *off*. Then lock off and tag out power to the machine at the wall disconnect before accessing the processor board.



DANGER 9: Electrocution hazard—Contact with electric power can kill or seriously injure you. Electric power is present inside the cabinetry unless the main machine power disconnect is off.

The location of the DIP switches on the microprocessor board are shown in [Figure 8](#), as are examples of the *on* and *off* positions. Set the switches to the desired configuration according to [Table 5](#). Turn the machine *on*; the display will show the current configuration.



CAUTION 10: Risk of improper configuration—On some machines, the processor board is installed in the control box so that the labels printed on the DIP switch appear inverted.

- Do not assume that the switch is right side up. Always reference the labels (*OFF*, *ON*, *1*, *2*, etc.) **printed on the switch** when setting DIP switches.

Figure 8: Location of DIP Switches

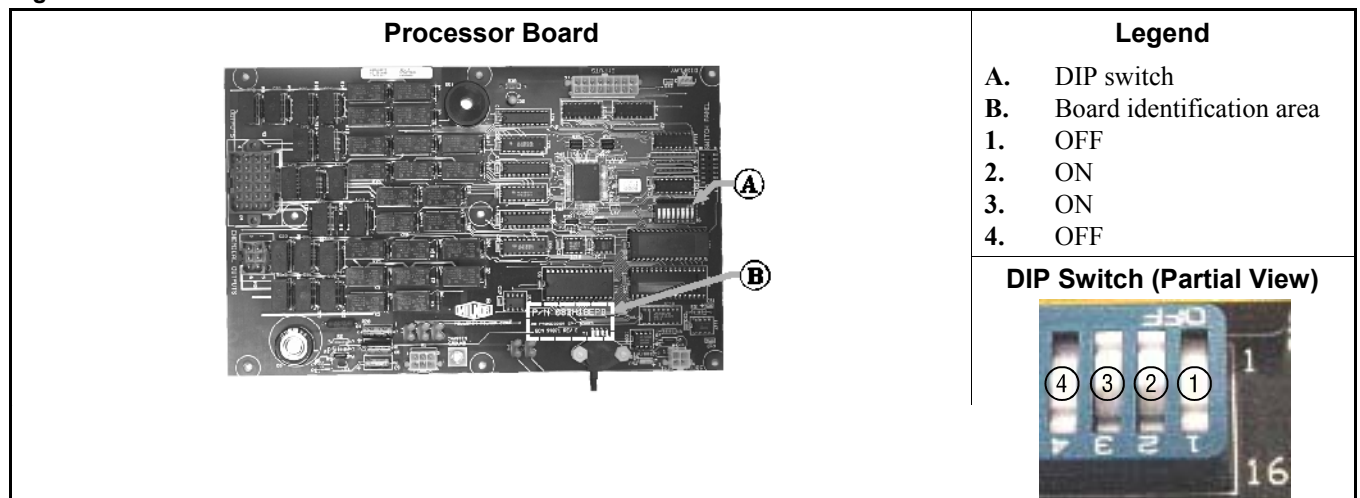

Table 5: DIP Switch Settings for Industry Configurations

Industry Configuration	Switch Settings							
	S1	S2	S3	S4	S5	S6	S7	S8
Correctional Facilities	ON	ON	ON	ON	This switch is not used in these models.	On prevents/Off allows skipping steps.*		
Hotels and Motels	OFF	ON	ON	ON				
Athletic Laundries	ON	OFF	ON	ON				
Healthcare Facilities	OFF	OFF	ON	ON				
Restaurants	ON	ON	OFF	ON				
Commercial Laundries	OFF	ON	OFF	ON				
Shirt Laundries	ON	OFF	OFF	ON				
Offshore Laundries	OFF	OFF	OFF	ON				
Fire-Fighter	ON	ON	ON	OFF				

* Setting S6 off enables the operator to cancel any step in progress except a drain before an extract.

— End of BICJHC02 —

BICJXP01 (Published) Book specs- Dates: 20070531 / 20070531 / 20070531 Lang: ENG01 Applic: CJX

2.3. Programming the E-P Express® Control

The microprocessor controller used in this washer extractor operates in two modes, depending on whether the machine is being used to process goods (the *Run mode* or *Formula* menu) or is being programmed with operating characteristics to be used when a wash formula is started (the *Program mode*). This document describes the available operator actions and display feedback in the *Program mode*.

The *Program mode* is accessible only when the *Run/Program keyswitch* is set to the *Program* position (), as described below. From the *Program* menu, there are four options available:

- Option 0: OK TURN KEY TO RUN (detailed in [Section 2.3.2](#))
- Option 1: ADD/CHANGE FORMULA (detailed in [Section 2.3.3](#))
- Option 2: CONFIGURE (detailed in [Section 2.3.4](#))
- Option 3: STANDARD FORMULAS (detailed in “Restoring the Standard Formulas”)
- Option 4: DATA TRANSFER (detailed in “Memory Transfer”)

Each of these options is described in detail in this document. For information on how to start the machine and run a formula, see the appropriate section listed in the table of contents of this manual.

2.3.1. How to Avoid Data Loss



CAUTION 11: Avoid Corrupting Formula Data—Never turn the *Run/Program keyswitch* from the *Program* position to the *Run* position unless the display says *OK Turn Key to Run*.

- Failure to follow this direction will result in the loss of all formula modifications entered during the current programming session. Formulas not modified during this session will not be affected.





CAUTION 12: Avoid Corrupting Configuration Data—Never shut off machine power to exit the *Program mode*.

- Once the *Configure* menu has been accessed, press 1 to return to the *Program* menu and

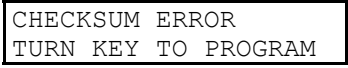

save all changes before turning off machine power.

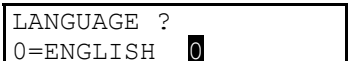
Use the following procedures to clear corrupted formula and configuration memory and restore valid data.



Display or Action	Explanation
	This display indicates that all memory will be cleared. The machine controller must be reconfigured and any new formulas or modifications to standard formulas must be re-programmed.
	Clears all memory and accesses the first configuration decision.
	First configure decision.

2.3.2. How to Return to Run Mode

Option 0 allows for a safe return from the *Program* mode to the *Formula* menu, preserving any changes that were made during the programming session and maintaining the integrity of programming and configuration data.

Display or Action	Explanation
	This is <i>Option 0</i> of the <i>Program</i> menu. From this display, return to the <i>Formula</i> menu or select another available menu option.
	Returns to <i>Run mode</i> (<i>Formula</i> menu)

or





 /  Scrolls the available choices in the *Program* menu.

2.3.3. How to Add or Change a Formula

Washer extractors with the Milnor® E-P Express® control system have the capacity for up to 30 unique wash formulas. The space for these formulas is allocated in memory whether or not the formulas are actually used.

The user interface employs similar procedures for creating a new formula and for changing an existing formula. Both procedures are detailed below, in [Section 2.3.3.3](#) and [Section 2.3.3.5](#). The control system will inform the person programming the machine whether the selected formula has already been programmed.

2.3.3.1. Quick Reference for E-P Express Programming—This part of this document briefly describes how to program a wash formula. For a more detailed description of navigating through the programming capabilities of this controller, see [Section 2.3.3.2](#). More information on creating and deleting formulas is in [Section 2.3.3.3](#) and [Section 2.3.3.4](#), respectively. [Section 2.3.3.5](#) describes how to modify an existing formula, and [Section 2.3.3.6](#) explains each programming decision.

1. Apply power to the machine.
2. After the normal power-up display and start-up safety delay, turn the *Run/Program* keyswitch to the *Program* position (.
3. Scroll ( / ) to *ADD/CHANGE FORMULA* and press the *Next* button () to confirm your choice.

4. Scroll (/) to an unused formula number (01 through 30) to add a new formula. The cursor will flash on “CHANGE.”
5. Press the *Next button* () to confirm your choice.
6. Select the type of step (TT) from the available options (00 through 14).

Tip: At this point, you can delete the formula by setting the type of step for Step 01 to “00.”

7. Press the *Next button* () to confirm your choice and advance to the next decision (MMQ).
8. Scroll the first (tens) digit to the desired value, then press the *Next button* () to confirm your choice and advance to the next digit.
9. Scroll the second (units) digit to the desired value, then press the *Next button* () to confirm your choice and advance to the next digit.
10. Scroll the third (quarter-minutes) digit to the desired value, then press the *Next button* () to confirm your choice and advance to the next decision.
11. For chemical injection in any bath step, use the *scroll buttons* (/) to enable or disable each chemical. Enable a chemical for injection by setting its value to *1*; disable a chemical by setting its value to *0*. Press the *Next button* () after each chemical selection to confirm your choice and advance to the next chemical.

Tip: Press the terminate button () to cancel the current choice and move the cursor to the previous decision.

12. Repeat this procedure for each step in the formula.
13. After the last desired step in the formula (usually an extract), add a step of type *00* to mark the end of the formula. The controller returns to the *Add/Change Formula* menu.

2.3.3.2. Moving through the Operations and Decisions—Each step is completely programmed on a single display:

Display or Action

F14 TT MMQ C:12345
S01 00

Explanation

In this example, “F14” at the left end of the display represents the formula number. “S01” below it represents the step number within that formula. When programming a formula position (e.g., Formula 14) for the first time, the TT field (type of step) will always be 00 (end formula) until you change it to another valid type of step.

2.3.3.3. How to Create a New Formula—Creating a new formula with the E-P Plus® controller entails adding and defining steps in one of the blank formula slots.

Display or Action

```
PROGRAM 1 MENU
ADD/CHANGE FORMULA
```

Explanation

This is *Option 1* of the *Program* menu. From this display, either access a formula by number to change or create, or select another available menu option.



Accesses the formula list for selection of a formula number to change or create.

```
ADD/CHANGE FORMULA
00 RETURN TO MENU
```

This is the *Add/Change Formula* display. From this display, either back up to the *Program* menu, or begin creating or changing a formula.



Scrolls the available formula numbers. If the selected formula number hasn't already been programmed, it is selected for *add*. If the number has already been programmed, it is selected for *change*, as shown in the following two displays.

```
ADD/CHANGE FORMULA
23 FORMULA NUMBER 23
```

Formula 23 is available for adding because it does not currently exist.

```
ADD/CHANGE FORMULA
07 FORMULA NUMBER 07
```

Formula 07 is available for changing because it already exists.



Accesses the selected formula for programming. Valid formula numbers are 01 through 30.

```
F07 TT MMQ C:12345
S01 00
```

Formula 07, Step 01 selected for programming.

2.3.3.4. How to Delete a Formula

Display or Action

```
F03 TT MMQ C:12345
S01 00
```

Explanation

Delete an existing formula by making step 01 an *End Formula* step. Set the *TT* value for step 01 of the formula to 00.

2.3.3.5. How to Change a Formula

2.3.3.5.1. How to Insert or Delete a Step in an Existing Formula

Display or Action

```
F03 TT MMQ C:12345
S01 06 070 11000
```

Explanation

When there is no cursor blinking on the display, steps can be reviewed, added or deleted.



Provides a help screen for inserting and deleting steps, as shown below.

```
START+NEXT/TERM TO
INS/DELETE THIS STEP
```

This is the help screen for inserting and deleting steps. Steps can only be inserted or deleted while the help screen is present, i.e., the button is depressed.



Insert or delete steps **if the Insert/Delete Step help screen is visible.**

2.3.3.5.2. Inserting a Step

Display or Action

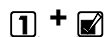

Explanation

Duplicates the selected step to the next numerical position. If this is Step 01, the duplicated step becomes Step 02 and all the following steps move to the next higher numerical position.

Duplication of *End Formula* or *Extract* steps is prevented by the controller.

```
F03 TT MMQ C:12345
S01 NEW STEP01 DUPED
```

This display indicates that the new step has been created as a copy of the previous step. Chemicals and injection times are not copied into the new step.

2.3.3.5.3. Deleting a Step

Display or Action

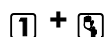

Explanation

Deletes the selected step. The next step becomes the current step by assuming the number of the step that was just deleted. All following steps move one number lower.

Deletion of *End Formula* is prevented in all cases. A *Bath* step can not be deleted if it falls between two *Extract* steps.

```
03 TT MMQ C:12345
01 STEP DELETED
```

This display indicates that the selected step has been deleted from the wash formula.

2.3.3.5.4. How to Save Changes—The control automatically saves the changes when you answer “Yes” to “End Formula #xx?”

Display or Action

```
Fxx TT TYPE OF STEP
Sxx 00 End Formula
```

Explanation

Step type 00 indicates that the formula is finished.



Accepts the selected step type (00 = End Formula) and prompts for confirmation to end the formula.

```
END FORMULA #xx ?
0 NO [1=YES]
```

Confirmation display for end of formula. Select “0 NO” by pressing to continue programming this formula. Select “1 YES” by pressing then to save this formula and return to the menu system.

2.3.3.6. The Step Decisions

2.3.3.6.1. TT = Step Type

Display or Action

```
F12 TT MMQ C:12345
S01 03 SPLIT SOAK
```

Explanation

This is an example of a formula programming display with the *Step type* field selected. There are 15 types of steps available for programming, although every step type is not available in every condition. For example, an extract operation can never be the first step in a formula nor immediately follow another extract. Press or to scroll to the desired step type, then press to choose the selected step type and move to the step time decision.

2.3.3.6.1.1. **End of formula (TT=00)**—This is the last step of any formula. When you program an *End of formula* step by entering *00 End of formula* and pressing , the controller saves the programmed formula and returns to the *Add/Change Formula* screen.

2.3.3.6.1.2. **Soak (TT=01, 02, or 03)**—Soaking serves to expose the goods to water and any included chemicals without mechanical action which might damage certain textiles. In this machine, **all soak baths are performed at high water level** and the selected waters (hot, cold, or split). Any chemicals may be injected.

The step timer begins counting when high level is achieved and continues for the programmed amount of time. When the step time expires, the controller commands the motor to turn the cylinder clockwise for four seconds at wash speed, then to accelerate to drain speed. A few seconds after the cylinder reaches drain speed, the drain opens. The next step begins after the fixed drain time and coast time expire. Coast time is not counted if the next step is an extract.

01=Hot soak—Use hot soaks to maximize the activity of the injected chemicals when there is little or no chance of stains being set by the high temperature. Temperatures above 120 degrees Fahrenheit (49 degrees Celsius) usually make the removal of protein-based soils more difficult.

02=Cold soak—Use cold soak steps for goods that contain protein stains. The low temperature is usually less effective than higher temperatures at activating certain chemicals, but the chance of setting stains is much lower.

03=Split soak—If the temperature of incoming hot water alone is higher than 120 degrees Fahrenheit (49 degrees Celsius), soaking with both hot and cold water simultaneously will remove more soil than a cold flush. A split soak is also less likely to set protein stains than a hot soak if the temperature of the split fill is consistently lower than 120 degrees Fahrenheit.

2.3.3.6.1.3. **Flush (TT=04, 05, or 06)**—A flush is usually used early in a formula, prior to bleaching, to dilute and remove debris and loose soil before chemicals are added. Flushes are also used to raise or lower the temperature of the goods. Machines with the E-P Express® controller conduct **all flushes at high water level** with the programmed waters (hot, cold, or split). Any chemicals may be injected, although this is not common.

For any flush operation on the E-P Express® controller, the step timer begins counting when high level is achieved and continues for the programmed time. The cylinder reverses at wash speed while the step timer is counting down. When the step time expires, the controller commands the motor to turn the cylinder clockwise for four seconds at wash speed, then to accelerate to drain speed. A few seconds after the cylinder reaches drain speed, the drain opens. The next step begins after the fixed drain time and coast time expire. Coast time is not counted if the step about to begin is an extract.

04=Hot flush—Use hot flushes to remove the maximum amount of debris and loose soil when there is little or no chance of stains being set by the high temperature. Temperatures above 120 degrees Fahrenheit (49 degrees Celsius) usually make the removal of protein-based soils more difficult.

05=Cold flush—Use one or more cold flush steps to remove debris and loose soil from goods that might contain protein stains before adding detergent. The low temperature is likely to be less effective than higher temperatures at removing certain types of soil, but the chance of setting stains is much lower.

06=Split flush—If the temperature of incoming hot water is higher than 120 degrees Fahrenheit (49 degrees Celsius), flushing with both hot and cold water simultaneously will remove more soil than a cold flush. A split flush is also less likely to set protein stains than a hot flush if the temperature of the split fill is consistently lower than 120 degrees Fahrenheit.

2.3.3.6.1.4. **Wash (TT=07, 08, or 09)**—Wash steps include break, suds, bleach suds, and carryover

operations, and occur after the final flush if one or more flushes are used. **All wash steps programmed with this controller use low water level.** The first step to introduce chemicals to the machine cylinder is usually called a break and includes the injection of alkali and detergent. Suds and bleach suds steps follow the break step.

Carryover steps use the chemicals retained in the goods after draining the previous step to prolong chemical contact at a higher temperature without introducing more chemicals. The drain prior to a carryover step also removes suspended soil and reduces bath alkalinity for better bleaching.

07=Hot wash—This step type causes the machine to fill exclusively through the hot water valve. Generally, the bath temperature should be as hot as is practical for suds baths, with some considerations. While higher temperatures increase the effect of detergents, there is a risk of setting certain stains if they were not sufficiently removed with earlier, cooler baths. High bath temperatures may also introduce creases into some synthetic fabrics by heating the fibers above the temperature at which they become plastic. When this happens, rapid cooling will often set the creases beyond the ability of other equipment to remove them. For the best effect, introduce chlorine bleach when the bath temperature is about 150 degrees Fahrenheit (66 degrees Celsius). Bleaching with chlorine at temperatures above 160 degrees Fahrenheit (71 degrees Celsius) is likely to damage fibers.

08=Cold wash—This step type uses only water at or near the temperature at which it entered the plant. In especially warm climates, this water may be at or above the temperature achieved by using split water in other areas. Program a cold wash any time the split water temperature might cause undesired results, including wrinkles or fiber damage.

09=Split wash—This type of step fills the machine by fully opening both the hot and cold water valves simultaneously. This results in the fastest possible fill and a bath temperature that is satisfactory for many applications. While certain factors such as pressure differences between hot and cold water supplies cannot be predicted, the approximate temperature of split water will be one half of the total of both the hot and cold water temperatures.

2.3.3.6.1.5. **Rinse (TT=10, 11, or 12)**—Bath operations between the bleach step and the finish step are usually called rinses. Rinses serve to remove the last of the loosened soil and most of the chemicals from the goods. In machines with the E-P Express® controller, **rinse steps are always performed at high water level** and the programmed temperature. This controller also allows the injection of any desired chemicals during rinse operations.

10=Hot rinse—Rinsing with hot water removes more detergent and other chemicals from the goods than a cold or split rinse, but also may have many of the same adverse affects as a hot wash. Consider the temperature of the hot water supply and the goods being laundered when programming this type of step.

11=Cold rinse—Use a cold rinse to remove most of the remaining chemicals from the goods without the energy cost of hot water. Keep in mind, however, that a cold bath immediately following a hot bath may thermoset creases in some synthetic fabrics.

12=Split rinse—Because both the hot and cold water valves are open for a split rinse, the fill time is approximately half of the time required for either a hot or cold rinse. Also, there is less chance for fabrics to crease than with a hot rinse, and more remaining soil and chemicals are removed than with a cold rinse.

2.3.3.6.1.6. **Finish (TT=13)**—The finish operation is usually the final bath operation of the wash formula. This controller allows the injection of any chemical, with sour, starch, and softener being the most common. **The bath level is always low**, and the water temperature is almost always cold. In locations where the incoming cold water is so cold that chemicals do not mix readily with the water, the machine can be configured to fill all finish steps with split water.

2.3.3.6.1.7. **Extract (TT=14)**—Extract operations are used between bath steps to remove water, chemicals,

and suspended soil; and as the final operation in a formula to remove water for faster drying.

2.3.3.6.1.8. Quick Reference for Step Types

Table 6: Summary of Step Types

Step Name	TT Code	Temperature	Basket Motion	Basket Speed
End of Formula	0 0	N/A	N/A	N/A
Soak	0 1	Hot	None	None
	0 2	Cold		
	0 3	Split		
Flush	0 4	Hot	Reversing	Wash speed
	0 5	Cold		
	0 6	Split		
Wash	0 7	Hot	Reversing	Wash speed
	0 8	Cold		
	0 9	Split		
Rinse	1 0	Hot	Reversing	Wash speed
	1 1	Cold		
	1 2	Split		
Finish	1 3	Cold (see Note)	Reversing	Wash speed
Extract	1 4	N/A	Clockwise	Extract speed
Note: A configuration decision allows the filling of finish steps for all formulas with either cold or split water.				

2.3.3.6.2. MMQ = Step Time

Display or Action

F12	TT	MMQ	C:12345
S01	06	032	03:30

Explanation

Typical programming display for step time. When the wash formula is running, the step timer begins counting from 00:00 when level is achieved for a bath step, or when the controller commands extract speed. The timer causes the current step to end when the programmed time elapses. Time is programmed in minutes, minutes, and quarter-minutes, with a maximum programmable time for each step of 633 (63 minutes and 45 seconds).

F12	TT	MMQ	C:12345
S01	06	020	00:00

First digit of step time field selected to change. ▲ increases value of this digit; ▼ decreases value.



Accepts value for this digit and selects next digit.



Cancels the current selection and moves the cursor to the previous selection.

Display or Action

F12	TT	MMQ	C:12345
S01	06	080	08:00

Explanation

Typical display after pressing to accept “0” as the first minutes digit, then pressing ▼ two times and once to select “8” as the second minutes digit. The controller is waiting for user input for quarter-minutes. The programmed time in minutes and seconds is displayed next to the programming fields.

F12	TT	MMQ	C:12345
S01	06	081	08:15

Select the number of quarter-minutes desired, then press to accept the desired step time and begin programming chemical injections.

2.3.3.6.3. **C = Chemicals**—All types of steps other than **extract** and **end of formula** allow chemical injection. The duration of the injection signal for each chemical is 30 seconds unless chemical 1 is **configured** for another value as described in [Section 2.3.4.2](#).

Display or Action

F12	TT	MMQ	C:12345
S03	06	081	00000

Explanation

Typical programming display for chemical injection.

The E-P Express® controller provides five separate injection signals and one manifold flush signal. Consult the person responsible for connecting the chemical supply system to the machine (usually the chemical supplier) for information on which chemical is connected to each signal. Record the chemical connection information in [Table 7](#) for future reference.



Toggles the selected chemical signal between 0 (off) and 1 (on). In each step all programmed chemicals are signalled simultaneously when the desired level is achieved. The chemical manifold flush signal activates 20 seconds after the chemical injection signal ends, and continues for 30 seconds.



Accepts the current on/off status for the selected chemical signal and advances to the next signal. After programming chemical 5, this action advances to the next step in the formula.



Cancels the current selection and moves the cursor to the previous decision.

Table 7: Chemical Signals and Supplies

Chemical Signal (from display)	Chemical Name
1	(usually detergent)
2	(usually bleach)
3	(usually sour)
4	(usually softener)
5	(usually starch)

2.3.4. How to Configure the Controller

Because the microprocessor control system used in this machine is capable of multiple languages and operating with many different chemical injection systems, each machine must be configured. This configuration informs the microprocessor of what language to use for displaying operator information and the duration of the inject time for chemical one.



CAUTION 13: Configure Data may be Lost—If the controller loses power either accidentally or intentionally while in the *Configure mode*, all configuration data may be corrupted. Reconfigure the controller at installation and any time a memory error is detected.

2.3.4.1. Moving through the Configure Screens

Display or Action

```
PROGRAM 2 MENU
CONFIGURE
```



```
LANGUAGE ?
0=ENGLISH 0
```

```
CHEM 1 INJ TIME: SSS
FORMULA 01 030
```



Explanation

This display indicates that the controller is in *Program mode* with the *Configure menu* selected for access.

Accesses the *Configure menu* and displays the first configuration decision.

The language option that appears here may vary according to how the controller was last configured.

The value that appears here may vary according to how the controller was last configured. These values are always reset to 30 seconds whenever the standard formulas are restored, as described in “Restoring the Standard Formulas” (see table of contents).

Accepts the displayed selection.

Accepts the displayed selection and reverts to the previous configure decision.

2.3.4.2. The Configure Decisions

Display or Action

LANGUAGE ?	0
0=ENGLISH	



Explanation

Display of *Language* configuration decision. The language chosen here controls all programming and operational prompts on the machine display.

Scrolls the available languages, listed below.

- 0 = English
- 1 = Spanish
- 2 = French
- 3 = German
- 4 = Dutch
- 5 = Italian
- 6 = Portuguese



Accepts the selected value for the current decision and advances the cursor to the next decision. This action is required for each configuration decision.

COLD OR SPLIT FINISH	0
0=COLD [1=SPLIT]	



As described in [Section 2.3.3.6.1.6](#), the finish step for all formulas can be configured to fill with either cold water or split water (both hot and cold). If you find that finish chemicals, especially starch, don't mix well with cold water, set this decision to fill all finish steps with both hot and cold water. The split fill decision is more commonly used in cold climates.

Toggles the selection between “0=COLD” and “1=SPLIT.”



Accepts the current selection and advances to the next configure decision.

TIME TO DRAIN	SSS
MIN=030 MAX=255	060

When the machine must be installed where draining is accomplished through solid piping instead of a drain trough, additional time may be required to completely drain the water from the machine. This decision sets the time after the drain opens until the controller signals the inverter to accelerate to extract speed. If low level is still achieved when this time expires, an error stating “Too Long to Drain” is displayed. The minimum value is 30 seconds; the maximum value is 255 seconds (4:15).



CAUTION 14: Motor damage and inverter fault hazard—The motor may be damaged and/or the inverter may trip frequently if the drain time is not long enough to allow most of the free water to exit the machine before extract begins.

- Factory testing has found that a drain time of 60 seconds provides some margin of safety for a machine that drains freely into an open trough. Increase drain time if the machine drains into an enclosed pipe, especially if that same pipe might simultaneously drain additional machines.

Display or Action

or

Explanation

Scrolls the selected digit.



Accepts the currently selected digit and advances to the next digit. Advances to the next configure decision if pressed when the rightmost digit is selected.

Display or Action

CHEM 1 INJ TIME: SSS
FORMULA 01 030

Explanation

Display of *Chem 1 inject time* configuration decision. Some chemical systems use the duration of the chemical 1 injection signal to determine which wash formula is running. Only the injection time for chemical 1 is configurable; all other chemical signals are fixed at 30 seconds. By default, *Chem 1 inject time* for each formula is 30 seconds until changed. The minimum value is 1 second; the maximum value is 255 seconds (4:15).

Supplement 3

About Chemical Injection with the E-P Express Controller

The normal duration for all chemical injection signals from this controller is 30 seconds.

This period often allows delivery of the desired amount of chemical when pump sizes and other factors are used to control chemical volume more precisely.

Installations requiring more precise chemical metering may use programmable chemical supply systems (provided by others) to select chemical amounts according to the washer-extractor formula. Typically these chemical systems use the duration of the washer-extractor injection signal for Chemical 1 to determine which formula is running, then select the corresponding chemical program for that wash formula.

When the chemical supply system determines the wash formula and selects the appropriate chemical program for quantities, the chemical system still needs to know when to inject each chemical. The chemical system monitors the washer-extractor controller for chemical signals in each step calling for chemicals. When the washer-extractor requests a specific chemical, the chemical supply system injects the programmed quantity of that chemical.

For example, the E-P Express® controller may be configured so the Chemical 1 signal is five seconds in formula 01, ten seconds in formula 02, and 15 seconds in formula 03. When the washer-extractor controller signals for Chemical 1 to be injected, the Chemical 1 output relay is turned *on* for the configured duration. The chemical injection system then determines which formula the washer-extractor is running and selects the chemical injection program corresponding to the wash formula.

Display or Action	Explanation
CHEM 1 INJ TIME: SSS FORMULA 01 030	Typical display with formula number field selected for change.
▲ / ▼	Scrolls the formula number up or down.
☑	Accepts the selected formula number and moves the cursor to the injection time field.
⏪	Accepts the current digit of the formula number and moves the cursor back to the previous decision (Time to Drain).
1	Writes all data to memory and returns to the <i>Program</i> menu.
CHEM 1 INJ TIME: SSS FORMULA 04 030	Typical display with the first digit of the time field for formula 4 selected.
▲ / ▼	Scrolls the selected digit up or down. The maximum value for any signal is 255 seconds; the minimum value is 000 (no injection).
☑	Accepts the current digit of the inject time and moves the cursor forward to the next digit. When the third digit is selected, the cursor advances to the formula number for the next formula.
⏪	Accepts the current digit of the inject time and moves the cursor back to the previous digit. If the first digit of the inject time is selected, the previous decision (Time to Drain) is displayed.
1	Accepts the current digit and saves all configure data.

Note 3: All inject times return to the default value of 30 seconds any time the standard formulas are restored to memory. The procedure for restoring standard formulas is described below.

Display or Action	Explanation
PLEASE WAIT	Appears while the controller writes all configure data to memory.
PROGRAM 2 MENU CONFIGURE	Indicates that all configure data was successfully written to memory. Select another program menu option to continue.

2.3.5. Restoring the Standard Formulas [Document BICJUP01]

Programming mode 3 allows the owner/operator with access to a programming key to perform either of these two actions:

1. *Option 0* replaces all existing formulas with the factory default formulas for the selected industry configuration. This selection replaces formulas 1 through 10 with the standard industry formulas and removes all data from formulas 11 through 30.

2. *Option 1* replaces only formulas 1 through 10 with the standard industry formulas. This leaves any user-programmed data in formulas 11 through 30 intact.



CAUTION [15]: Avoid Data Loss—Other than the two methods described above, it is not possible to selectively delete field-modified or field-programmed formulas with this programming mode. This mode erases all field-programmed formulas 1 through 10 or 1 through 30 as specified. For selective deletions and modifications, use *Program mode 1* (Add/Change Formula).



CAUTION [16]: Avoid Chemical Damage to Goods—The injection time for Chemical 1 is 30 seconds for all default formulas. This may prevent certain chemical supply systems from properly detecting which formula is running, or cause the injection time for chemical 1 to be longer than intended.

- Always verify the Chemical 1 injection time for each formula after restoring the standard formulas.

Figure 9: Procedure for Restoring Standard Formulas

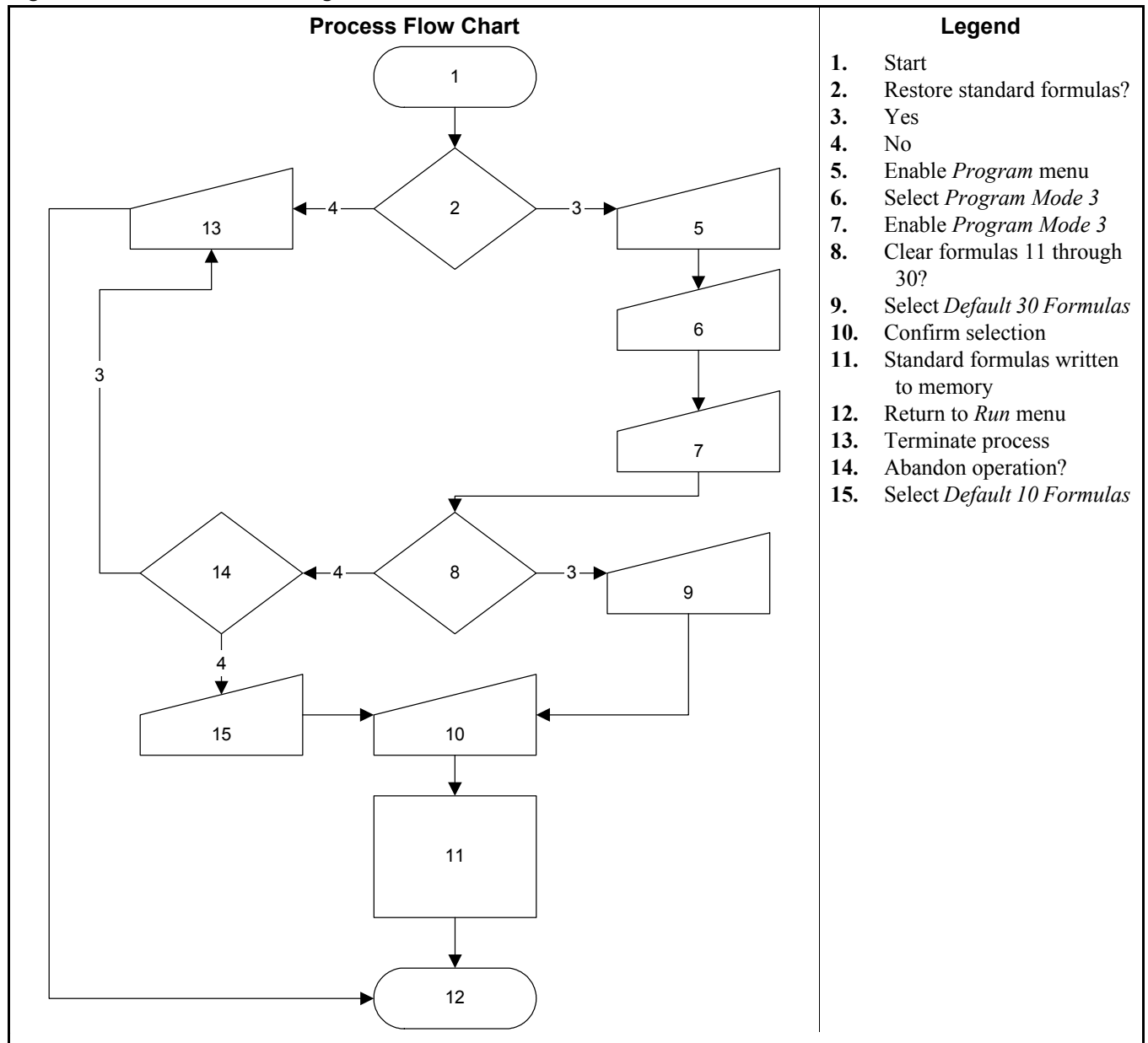

The remainder of this document details the procedure for restoring the industry standard formulas on models employing the Milnor® E-P Express® controller.

Display or Action	Explanation
	This is <i>Option 0</i> of the <i>Program menu</i> . From this display, either return to <i>Run mode</i> or select another menu item.
	Scrolls available choices (0 through 3) in the <i>Program menu</i> .
	This is <i>Option 3</i> of the <i>Program menu</i> .
	Accesses the <i>Standard Formulas</i> option of the <i>Program menu</i> .
	<i>Option 0</i> (Default 30 Formulas) of the <i>Standard Formula menu</i> effectively deletes all 30 formulas, then replaces formulas 1 through 10 with the factory-supplied standard formulas for the configured industry. Formulas 11 through 30 are replaced with blank formulas.
	<i>Option 1</i> (Default 10 Formulas) deletes only formulas 1 through 10 and replaces them with the factory-supplied standard formulas for the configured industry. Formulas 11 through 30 are not modified with this selection.
	Scrolls the available choices (<i>0 Default 30 Formulas</i> or <i>1 Default 10 Formulas</i>).
	Cancels this procedure without changing or deleting any formulas.
	If the procedure is cancelled, the display returns to <i>Option 3</i> of the <i>Program menu</i> .
	From either option <i>0</i> or option <i>1</i> , defaults the selected set of formulas: 1 through 30, or 1 through 10.
	Appears for approximately five seconds as the standard formulas are written to memory.
	Replaces the previous display when the process is completed.
	Scroll to <i>Program menu</i> item <i>0</i> before exiting <i>Program mode</i> .
	This is <i>Program menu</i> item <i>0</i> . It's now safe to turn the <i>Run/Program keyswitch</i> to the <i>Run</i> position.
	Returns to <i>Formula menu</i> .
	<i>Formula menu</i> ; run a formula or shut down the machine.

2.3.6. Data Transfer (Option 4) [Document BICJUP13]

Certain Milnor® controllers described in this manual can transfer memory between the machine and a Milnor serial memory storage device or between two machines. Refer to [Table 8](#) to determine the hardware and software requirements for memory transfer. See [Section 5.3](#). “Construction of External Serial Link Cables” for inter-machine cable specifications and assembly instructions.

Table 8: Controllers Capable of Transferring Memory

Machine Controller	Typical Machine Models	Controller Software Later Than	Processor Board Later Than
E-P Express	30015T_X, 30022T_X	WUEPXPRSA/22004	08BH18EPYT REV. K
E-P Express Gear Guardian		WUT5XGGA/22GGF	
E-P Plus	30015V_J, 36026V_J, 42026V_J	WUV7J1B/2200K	08BH18EPDT REV. K
	30015H_J, 30022H_J	WUH7J1A/2200E	
	30022X_J	all versions	



CAUTION 17: **Configuration data will be overwritten.**—When transferring data from one machine to another, the formulas and configuration data of the *Master* machine will be written to the *Slave* machine. Partial memory transfer is not possible.

- Record all configure data from the *Slave* machine before beginning the download, especially “Offset Height.” Restore this value to the *Slave* machine after the download is finished.
- For best results both machines in a machine-to-machine transfer must be identical models with identical options and controller software, and industry configuration (e.g., 36026V6J with steam, hot and cold water; software version WUV7J1B/2200K; and configured for Commercial Laundry facilities).

Notice 18: For data transfer to succeed, the processor boards on all included washer-extractors must have the Milnor part number specified in [Table 8](#) with the specified software installed.

- The Milnor part number for the processor board appears on a white sticker near the Milnor logo on the processor board.
- The revision level of the processor board is white lettering stamped directly on the green circuit board, located below the part number sticker. Look for “REV. K.”
- The processor board software version appears on a white label affixed to one of the large integrated circuit components on the processor board.

Figure 10: Controls Identification on Serial Memory Storage Device

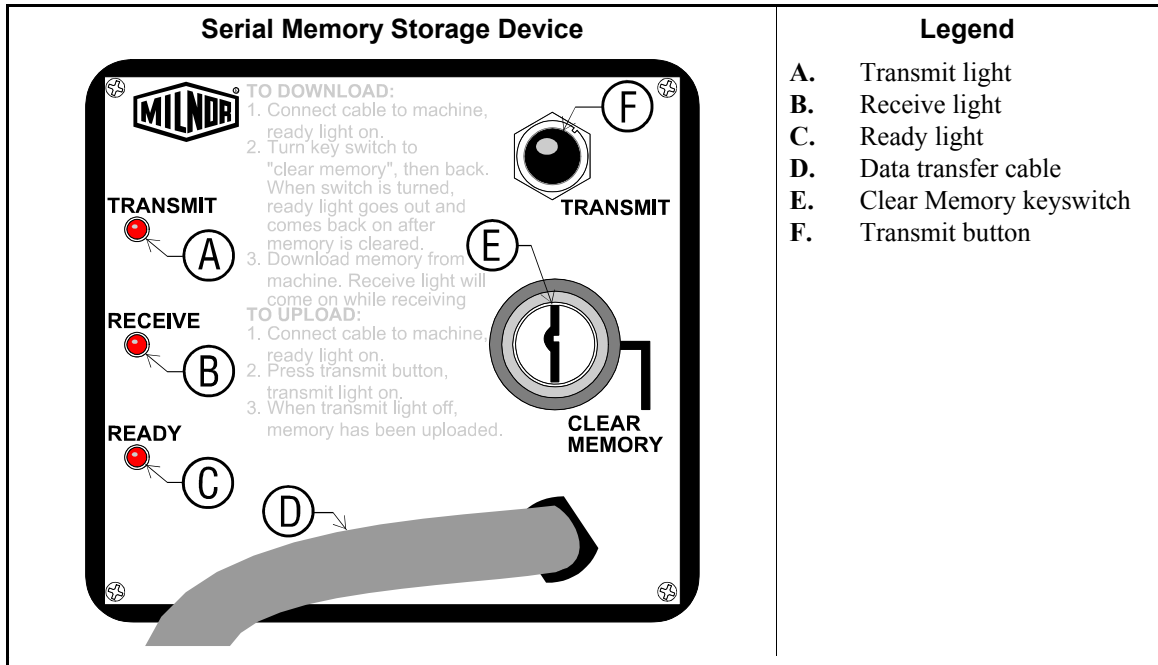

2.3.6.1. Establishing the Required Connections

Display or Action

Explanation



Turn off power to the machine before connecting the serial memory storage device or connecting the two machines together.

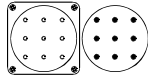

Connect the storage device to the machine, or the two machines together, using the 9-pin round connector.



Apply power to the machine(s). The storage device receives power through the connector from the power supply in the machine.



Turn the key on the storage device to *Clear Memory*, then return the key to the normal vertical position. This process is handled automatically when transferring from one machine to another.



The *Ready* light on the storage device will remain off until the clearing process is complete. The clearing process is fully automatic and requires no user action beyond turning the key to *Clear Memory* and returning it to the normal position.



When the *Ready* light comes on again (after about 45 seconds), the storage device is ready to accept data from the machine controller.



CAUTION 19: Ensure Data Integrity—Clear the memory storage device before saving data to it.

- The memory storage device will hold all programming and configuration data for one machine, and can be re-used many times. However, this device will only accept new data when it's empty.
- Attempts to save data to a storage device that has not been cleared will fail, **even if the procedure appears successful.**



When the *Run Program* display appears, switch from *Run* mode to *Program* mode.



Turn the *Run/Program* keyswitch on the machine controller(s) from the *Run* position to the *Program* position.



Controller display when the *Run/Program* keyswitch is set to  (*Program* position).







Scroll down in the *Program* menu to *Data Transfer*. If two machines are connected together, this is required at both machines.



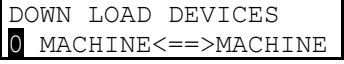

This is the *Data Transfer* menu selection. Follow the procedure in [Section 2.3.6.2](#) for making a copy of good data from the machine controller. Refer to [Section 2.3.6.3](#) for instructions on restoring previously saved data from the storage device (or another machine) to the machine controller, as might be required after changing the processor board.

2.3.6.2. Saving Data from the Machine to the Storage Device or a Second Machine

Display or Action	Explanation
	Confirms selection and advances to the <i>Data Transfer</i> menu.
	This is the <i>Data Download</i> sub-menu. Select the desired type of data transfer here.
	There are two selections available in the <i>Data Transfer</i> menu: <i>0=Slave</i> and <i>1=Master</i> .
	For saving information to the data storage device or another machine, select <i>1=Master</i> at the machine controller. If two machines are connected, establish the one which will receive the data as the slave, and the sending machine as the master.
	The machine controller is set as the <i>Master</i> device, making the storage device the <i>slave</i> .



Note 4: The *Master* device is always the **sender** and controls when the data transfer starts. The *Slave* device is always the **receiver** and should be established and waiting for data before the *Master* device is confirmed.

Notice 20: Do not send data to the memory storage device until the storage device is cleared and ready to receive. The *Ready* light must be **on** when transfer begins or the stored data will not be valid.

	Confirms selection of the machine controller as the Master and immediately begins the transfer. All receiving (slave) machines must be established before the master machine is designated.
	While the data transfer is occurring, the four digits at the top right of the display scroll rapidly as the machine controller sends data.
	

The *Receive* light on the storage device illuminates when the data transfer begins, indicating that it is receiving data. The display on the slave machine scrolls quickly as data is accepted.

Note 5: Transfer times may vary somewhat, but the average is about 75 seconds.

	This display indicates that the machine controller delivered the data to the storage device.
	

The *Receive* light on the storage device goes off when the transfer successfully ends. If all three lights on the storage device begin blinking at any time during the transfer, the data being received by the storage device is invalid. Clear the memory in the storage device and perform the transfer again.

Display or Action

Explanation



CAUTION 21: Data Corruption Hazard—If the machine controller indicates that the data transfer is complete but the *Receive* light on the data storage device is still illuminated, invalid data is stored in the storage device.

- Do not rely on the data in the storage device unless the machine controller indicated that the transfer completed, **AND** the *Receive* light on the storage device turned off automatically.
- Do not restore data from the storage device to the machine if the data is invalid. Restoring invalid data from the storage device to the machine controller will overwrite any formulas that have been changed or created since the data was last stored. These formulas can not be recovered.



Acknowledges that the data transfer is complete and returns to the *Program* menu.



Data Transfer menu display. Scroll to *Program* menu item 0, then turn the *Run/Program* keyswitch to the *Run* position.



Scroll the *Program* menu selections.



From item 0 of the *Program* menu, return to normal operating mode.



Return to normal operating mode. Press  if necessary to confirm that the key is at *Run*.



The *Run Program* display appears to indicate that it is safe to turn the machine off.



Turn off power to the machine(s).

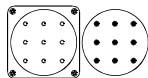

Disconnect the memory storage device, remove the key, and put both in secure locations. For two machines, remove the connecting cable.

2.3.6.3. Restoring Saved Data to the Machine from the Storage Device or Another Machine

Display or Action



Explanation

Turn off power to the machine(s) before connecting the serial memory storage device.

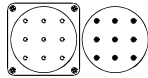

Connect the storage device to the machine using the 9-pin round connector. For two machines, use a serial cable constructed as described in [Section 5.3](#). “[Construction of External Serial Link Cables](#)”.



Apply power to the machine(s). The storage device receives power through the connector from the power supply in the machine.

```
RUN PROGRAM
00 OK TO POWER OFF
```

When the *Run Program* display appears, switch from *Run* mode to *Program* mode.



Turn the *Run/Program* keyswitch on the machine controller(s) from the *Run* position to the *Program* position.

```
PROGRAM 0 MENU
OK TURN KEY TO RUN
```

Controller display when the *Run/Program* keyswitch is set to  (*Program* position).



Scroll down in the *Program* menu to *Data Transfer*.

```
PROGRAM 4 MENU
DATA TRANSFER
```

This is the *Data Transfer* menu selection. Follow the procedure in [Section 2.3.6.2](#) for making a copy of good data from the machine controller.



Confirms selection and advances to the *Data Transfer* menu.

Display or Action

```
DATA TRANSFER
0 SLAVE
```

Explanation

The machine controller is set as the *Slave* device, making the storage device the *Master*. The *Master* device always controls when the data transfer starts and **sends** the data to the slave device. If transferring data from one machine to another, **the slave machine will receive the data sent from the master**.



Confirms the selection of the machine controller as the *Slave* device.

```
DATA TRANSFER
** PLEASE WAIT **
```

Appears for three seconds as the machine controller prepares machine memory to accept data from the storage device. When this display appears, all memory in the machine controller is cleared.

```
PLEASE WAIT 0000
RECEIVING DATA
```

This display indicates that the machine controller is polling the data storage device for incoming data. The four characters at the right end of the top line show the memory location currently being written. These characters remain at “0000” until the transfer begins.



Press the *Transmit* button on the data storage device or confirm the *Master* setting on the sending machine to begin the transfer.

Display or Action



Explanation

As soon as the *Transmit* button on the data storage device is pressed (or on the master machine), the storage device begins sending a continuous data stream to the slave machine controller. The machine display shows the progress of this display in the four characters on the top line. The transfer is complete when the display shows “FFFF.”



The *Transmit* light on the data storage device turns off when the transfer completes.

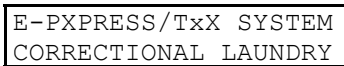

Appears for about one half second as the machine controller updates all memory.



Appears briefly (about one half second) as the machine controller verifies that the checksums calculated for the downloaded data match the checksums sent by the data storage device.

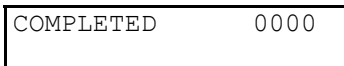

This display indicates that the data received by the machine controller matches exactly the data sent by the storage device. The data transfer was successful.



Acknowledge that the data transfer is complete and returns to the *Program* menu.



Data Transfer menu display. Scroll to *Program* menu item 0, then turn the *Run/Program* keyswitch to the *Run* position.



Scroll the *Program* menu selections.



From item 0 of the *Program* menu, return to normal operating mode.



Return to normal operating mode. Press if necessary to confirm that the key is at *Run*.

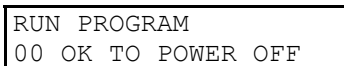

The *Run Program* display appears to indicate that it is safe to turn the machine off.



Turn off power to the machine(s).

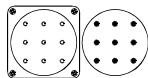

Disconnect the memory storage device, remove the key, and put both in secure locations.

— End of BICJXP01 —

Chapter 3

Operating

BICJHO01 (Published) Book specs- Dates: 20070531 / 20070531 / 20070531 Lang: ENG01 Applic: CJX

3.1. Running a Formula

3.1.1. Applying Power

Display or Action

Explanation



The *Run/Program keyswitch* must be set to the *Run* position before the main wall disconnect (fuse or circuit breaker) is closed to provide power to the machine.

When power is first applied to the machine, the display shows the software copyright information, machine name, and the checksum number. The checksum number changes with any programming change. To detect unauthorized programming, record the checksum at the end of each authorized programming session and compare it to the checksum displayed at each power up.

Milnor[®] washer extractors with E-P Express[®] controls do not use a speed sensing device to verify that the basket has stopped rotating. Therefore, when power is first applied to the machine, at least 80 seconds must elapse before any further operations can be attempted. This provides sufficient time for the basket to coast to a complete stop if power was lost while the machine was in high speed extract and restored before the basket stopped.



DANGER [22]: Entanglement Hazard—The linen inside or hanging partially outside a turning cylinder can suddenly wrap around your hand, arm, or body. The inertia of the spinning cylinder can cause the entangled linen to twist off or sever body parts. You can be killed or seriously injured.

- Never put any part of your body inside this machine or touch the linen while the machine is turning.

3.1.2. Selecting and Starting the Formula

- 3.1.2.1. Load Machine and Close Door**—Load the machine to the rated capacity and securely close the loading door. Review Determining Load Size (the related section in document BIWU001, or see the table of contents) for guidelines on loading machines.

3.1.2.2. Selecting a Formula

Display or Action	Explanation
<pre> RUN FORMULA 00 OK TO POWER OFF </pre>	<p>This is the <i>Run Formula display</i>. From this display, the operator can disconnect power from the machine without risking damage to electronic parts, or he can select a formula to run, as described below.</p>
▲	indexes forward through the 30 formulas.
▼	indexes backward through the 30 formulas.
<pre> RUN FORMULA 07 FORMULA NUMBER 07 </pre>	<p>Example display: Formula 07 selected for running.</p>
1	starts the machine with the selected formula.
<pre> RUN FORMULA DOES NOT EXIST </pre>	<p>indicates that the formula selected for running has not been programmed or is not available. This display appears for three seconds.</p>

3.1.3. Unloading the Machine

How a formula ends may depend on whether the formula finishes without interruption or is terminated manually.



DANGER 23: Entanglement Hazard—The linen inside or hanging partially outside a turning cylinder can suddenly wrap around your hand, arm, or body. The inertia of the spinning cylinder can cause the entangled linen to twist off or sever body parts. You can be killed or seriously injured.

- Never put any part of your body inside this machine or touch the linen while the machine is turning.

When a formula ends normally or is terminated, the door remains locked while the cylinder coasts to a stop. The door unlocks 80 seconds after the formula ends.

Display or Action	Explanation
<pre> UNLOCKING THE DOOR ** PLEASE WAIT ** </pre>	display during the coast period when a formula ends.
<pre> WAITING TO UNLOAD U </pre>	At the end of the coast time, the operator alarm sounds.
⊘	Silences the operator alarm. The door unlocks, and the machine may be unloaded.

3.1.4. The Display During Automatic Operation

Display or Action	Explanation
<pre>23:04 F02S01 02:37 L=A1/D1 Hot Wash</pre>	<p>These two displays alternate during normal operation while any chemical injection signal is enabled. The number on the right end of the bottom line indicates the number of seconds remaining in the longest programmed injection.</p> <p>23:04 is the time remaining in the formula.</p> <p>F02S01 indicates that the current formula is 02 (F02) and the current step is 01 (S01).</p> <p>02:37 is the time remaining in this step.</p>
<pre>23:04 STEP# 01 02:37 CHEM 1+2 025</pre>	<p>EXTRACT indicates that the machine is currently executing an extract.</p> <p>TIMEHALT indicates that the timer is stopped while a chemical is being injected. The chemical supplier must connect equipment for this option.</p>
<pre>23:04 F02S01 02:37</pre>	<p>L=A0/D2 indicates that level 1 (low level) has not been achieved, and level 2 is desired. A1/D2 indicates that level 1 is achieved, but level 2 (high level) is desired.</p> <p>The programmed step type appears to the right of the level indicator. The step type includes the temperature range, indicating which water valves are used to fill the machine.</p>
<pre>23:04 EXTRACT 02:37</pre>	
<pre>L=A0/D2 Hot Rinse</pre>	

3.1.5. How to Shorten, Terminate, or Suspend a Running Formula

Display or Action	Explanation
<pre>☑ + 1</pre>	<p>Cancels a step. Advances the step timer to zero for any bath, a drain not followed by an extract, or any extract in progress. The next step begins automatically.</p> <p>This operation is possible only if DIP switch 6 on the processor board is in the <i>off</i> position, allowing the cancelling of steps.</p>
<pre>☒</pre>	<p>Cancels the current formula and returns the machine to the <i>Run Formula</i> display.</p>
<pre>RUN FORMULA 00 OK TO POWER OFF</pre>	<p>This is the <i>Run Formula</i> display. The door interlock delay, described in Section 3.1.3, must expire before the door can be opened.</p>

3.1.6. How to Restart after Power Loss

The E-P Express® control remembers the formula and step it was executing if power fails or if the wall disconnect is turned off while the machine is operating in automatic mode.

Display or Action

```
PRESS START TO RUN
STEP xx - FORMULA yy
```

Explanation

On most machine models, this display appears when power is restored. The formula and step which were in progress when power was interrupted are shown.

- 1 Resumes the formula at the displayed formula and step. If the outage occurred in a bath step, level must again be satisfied, even if it was already satisfied before power was lost. Any commanded chemicals will be injected again.

If the outage occurred during a drain, that step will be repeated, then followed by the next commanded step.

If the outage occurred during an extract step, the previous bath will be repeated before the extract step begins.

- 2 Terminates the formula in progress.

3.1.7. How the Flush Valve Works

The E-P Express® controller provides an output signal that activates the flush valve for 20 to 30 seconds 15 seconds after the last chemical injection for each bath ends. If a bath is shortened or terminated before or while this valve is energized, the flush valve will be turned off. Shortening or terminating a bath may prevent the flush valve from activating.

— End of BICJHO01 —

BICJUD01 (Published) Book specs- Dates: 20070531 / 20070531 / 20070531 Lang: ENG01 Applic: CJX

3.2. Viewing and Clearing the Formula Count Accumulator

The microprocessor controller increments a discrete counter for each formula near the end of the formula. This count is maintained until the counter is cleared. The maximum number of times a formula can be counted before resetting the accumulator is 999, after which the count will remain at 999 until cleared. The count for each formula can only be viewed and/or cleared while the machine is in the *Run* mode but not running a formula (machine is idle).



CAUTION 24: Avoid Corrupted Accumulator Data—The accumulated data can be corrupted or become inaccurate if power is lost for an extended period of time, the maximum count of 999 is reached, or the memory is corrupted by electrical interference.

- Apply power to the machine for at least 15 seconds every 48 hours to retain the formula count. See “Important Owner/User Information” for more detailed information.
- To help ensure an accurate count, record the value and clear each accumulator before it reaches 999 counts.
- If the display shows “Accumulator Error,” the count for all formulas must be cleared. See the document on error messages for more information.

Display or Action



Explanation

This is the normal display at power-up.

Selects a formula by indexing forward/backward through the formula numbers (01-30).

With any formula selected,

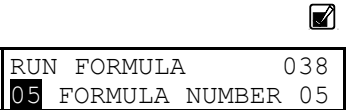

Displays the count in the upper right corner of the display.

This example shows that 38 loads were processed with formula 05 since the counter was reset.



Clears the count for the selected formula.

— End of BICJUD01 —

Chapter 4

Testing and Troubleshooting

4.1. Error Messages

4.1.1. Error Messages at Power Up

If an error message appears during power up, the error must be cleared before the machine can be run or programmed.

Display or Action	Explanation
ACCUMULATOR ERROR TERMINATE TO CLEAR	The microprocessor performs a memory check each time the machine is turned on. This error message appears if the microprocessor detects that the accumulator data is corrupt, in which case all accumulators must be reset to zero.
	Resets all accumulators and clears the error message. See “Viewing and Clearing the Formula Count Accumulator” (see Table of Contents) for more information.
CHECKSUM ERROR, TURN KEY TO PROGRAM	Appears if there is illegal data in the configuration, formula, or industry memory areas. Use the following procedure to clear this error. <ol style="list-style-type: none"> 1. Reconfigure the machine according to the configuration information in “Programming the E-P Express® Control” (see Table of Contents). 2. Reinstall the standard (default) formulas according to the default formula loading procedure in “Programming the E-P Express® Control”. 3. Reprogram any lost wash formulas according to “Programming the E-P Express® Control”.
MEMORY: FLASH IS NOT TALKING	This message appears when the microprocessor cannot read from the flash memory. <ol style="list-style-type: none"> 1. Lock off and tag out power to the machine. 2. Replace flash memory. Contact the Milnor® factory to ensure that the replacement memory is the most current version for your machine. 3. Restore power to machine. 4. Reconfigure the machine according to the configuration information in “Programming the E-P Express® Control” (see Table of Contents). 5. Reinstall the standard (default) formulas according to the default formula loading procedure in “Programming the E-P Express® Control”. 6. Reprogram lost wash formulas according to “Programming the E-P Express® Control”.

4.1.2. Error Messages during Normal Operation

If an error message appears on the bottom line of the display while the machine is running, the timer shown on the top line will stop counting. When the error is corrected, the timer resumes counting down. To troubleshoot most errors, suspend the formula in progress and turn power off. Do not terminate the formula if it is to be resumed after the error is corrected. See [Section 3.1.5 “How to Shorten, Terminate, or Suspend a Running Formula”](#) for more information.

Display or Action	Explanation
DOOR NOT CLOSED	This error message indicates that the door input is not made while the machine is running. Verify that the door is closed, then check the door switch and its connection to the microprocessor. Press <input type="button" value="1"/> if necessary to resume operation after the error is corrected. Never operate this machine while this message is present.
CHECK LEVEL SWITCH	The level switch may be faulty, perhaps reporting that level 2 was achieved before level 1. Check the pressure transducer, or the level switch and its input connection to the microprocessor.
LEVELS STILL MADE	The microprocessor is still receiving information that a level is made just before or during an extract step, or immediately before the fill for a bath step. This error is self-clearing when level is lost.
TOO LONG TO FILL	Time to fill to level exceeded 10 minutes. Check the water valves, strainers, supply lines, and water pressure. The machine will continue to fill until level is reached, at which time the error will automatically clear and normal operation will resume.
TOO LONG TO DRAIN	The machine did not drain properly in the allotted drain time. This self-correcting error will clear when the water level in the basket is low enough to begin the next operation. The drain time before this message appears is controlled by a configure decision. See the related section in document BICJUC01.
EXTERNAL FAULT	On most machines, this error indicates that the programmed chemical injection failed, usually because the chemical supply system is empty. When chemicals are added and can be injected, this error clears automatically, allowing operation to resume. On 48040F7J/F7B models, this error indicates that the bearing air pressure is below the minimum required to help protect the bearing from water contamination.
THREE WIRE DISABLED	The three-wire relay de-energized. This relay provides control circuit power to the machine. Once energized by momentarily depressing the <i>Start</i> button, it is held energized by its own normally open contacts, along with motor overloads, door interlocks, etc. Should any of these contacts open even momentarily, the machine stops and this display appears. This error can only be cleared by depressing the <i>Start</i> button, and only then if the error has been cleared.
INVERTER FAULT	This error message appears if the microprocessor does not receive an input from the inverter within 14 seconds of the beginning of the formula. After 14 seconds without an inverter input, the timer stops, the basket is stationary, and the drain valve opens. To recover, press the Next key (<input type="checkbox"/>).

Display or Action	Explanation
<div style="border: 1px solid black; padding: 2px; width: fit-content;"> VIBRATION SW TRIPPED RECOVERY SEQUENCE </div>	<p>When the vibration switch closes, the timer stops. After 45 to 85 seconds, the basket reverses at wash speed as the cylinder fills with water. When low level is achieved, the cylinder reverses for one additional minute at wash speed, then accelerates to extract speed.</p>

— End of BICJHT01 —

BICJHT03 (Published) Book specs- Dates: 20070531 / 20070531 / 20070531 Lang: ENG01 Applic: CJX







4.2. The E-P Express® Manual Menu

4.2.1. The *Manual Menu*

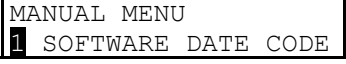

4.2.1.1. Components—The *Manual menu* contains these selections:

1. *Software Date Code*—a display of the software type and date code, both of which are fixed in the software; and the industry type, which is determined by setting the DIP switches on the processor board.
2. *Test Inputs*—allows viewing of microprocessor inputs for testing when a formula is not running. Devices, including the door latch and the level transducer, provide signals to the microprocessor by grounding certain inputs. The status of these inputs can be monitored in this mode, and changes to the input status will appear instantaneously. Refer to [Section 4.2.6](#) to view the status of inputs while the machine is operating.
3. *Test Outputs*—allows the actuation of outputs for testing when a formula is not running. Outputs are signals from the microprocessor to other devices, such as chemical pumps and motor contactors. Refer to [Section 4.2.6](#) to view the status of outputs while the machine is operating.
4. *Test DIP Switch*—displays a hexadecimal number which is unique for each possible setting of the DIP switch. This number can be used with the appropriate tables to determine the industry configuration of the machine, as well as whether the machine is configured to allow the operator to skip certain steps during automatic operation.



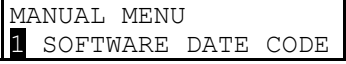

4.2.1.2. How to Access the *Manual Menu*

Display or Action	Explanation
	The machine must be idle (power on, but not running a formula) before the <i>Manual menu</i> can be accessed. Also, the <i>Run/Program keyswitch</i> must be at the <i>Run</i> position ( .
	Accesses the <i>Manual menu</i> .
	Reverse type indicates blinking cursor position. Select one of the <i>Manual menu</i> modes or return to the <i>Run mode</i> , as described below.
 / 	Scrolls forward/backward through the available modes of the <i>Manual menu</i> .
	Returns to the <i>Run mode</i> .
	<i>Run mode</i> selected; control is awaiting selection of a valid formula number. The formula number that was selected when the <i>Manual menu</i> was accessed appears on the display.

4.2.1.3. How to Return to the *Run Mode* from the *Manual Menu*

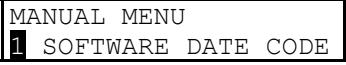
Display or Action	Explanation
	Enters the <i>Manual menu</i> from <i>Run mode</i> .
	This is the <i>Manual menu</i> display.
	Exits the <i>Manual menu</i> to the <i>Run mode</i> .
	This is the <i>Run mode</i> display. Select a formula to run, or turn off machine power.

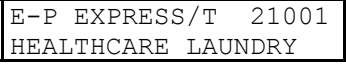
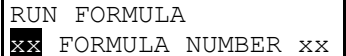
4.2.2. Determining the Software Version

Display or Action	Explanation
	Accesses the <i>Manual menu</i> .
	<i>Manual menu</i> accessed and <i>Software date code mode</i> selected.
 + 	Hold both buttons depressed to view the software date code and machine configuration information, as shown below.
	Machine style (/T = T_X), software date code (21001), and configuration (Healthcare Laundry).
	<i>Run mode</i> display is restored when the  +  button combination is released.

4.2.3. Viewing Microprocessor Inputs

The on/off state of each input to the microprocessor can be displayed by using the *Test Inputs* selection of the *Manual menu*. The machine must be idle (not running a formula).





Display or Action	Explanation
	Accesses the <i>Manual menu</i> .
	<i>Manual menu</i> accessed and <i>Test Inputs</i> mode selected.
	Accesses the <i>Test Inputs</i> mode.
	The input display code on the top row corresponds to a display code in Table 9 . The status of the input is displayed beneath each code. If the input is grounded, a “+” appears. Non-grounded inputs are represented by “-”.
	Restores the controller to the <i>Run mode</i> .
	This is the <i>Run mode</i> display. Select a formula to run, or shut down the machine.

Table 9: E-P Express Inputs

Display Code	Input Name	Connector-Pin
A	Door closed	M6-1
B	Low water level	M6-9
C	Vibration switch tripped	M6-2
D	Input from Inverter	M6-10
E	High water level	M6-3
F	Keyswitch in Program position	M6-11
G	not used	M6-4
H	Halt—external fault	M6-12
I	Halt—bath time	M6-5
J	not used	M6-13
J	Door open desired	M6-13
K	not used	M6-6
L	not used	M6-14

4.2.4. Actuating Microprocessor Outputs

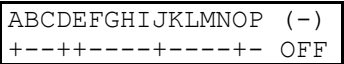
Machine functions may be tested individually or in groups by using the *Test Outputs* component of the *Manual menu*. The machine must be idle (not running a formula).



DANGER 25: Crushing and Entanglement Hazard—Bare manual outputs actuate washer-extractor mechanisms. Keep all personnel clear.















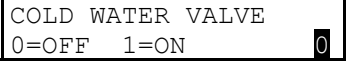

Display or Action	Explanation
	Accesses the <i>Manual menu</i> .
	This is the <i>Manual menu</i> display with the <i>Test Outputs</i> component selected.
	Accesses the output testing selection.
	This is the <i>Output testing</i> display.
	Indexes forward and backward through the output names, as shown in Table 10 .
	Example display with output in place to be selected and subsequently actuated.
	Accesses the selected output for actuation. All outputs are initially disabled when accessed.
	Example display with output accessed and disabled.
	Enables the output (turns the output on).
	Example display with output enabled. The cold water valve is open.
	If the output was already on, this keystroke turns it off.
	Example display with output disabled. The cold water valve is closed.
	Disables (turns off) the output if it was previously enabled, and advances to the next output.
	Display after pressing  to advance to the next output.
	Disables the output if it was enabled, then returns to the <i>Run mode</i> .
	Display of <i>Run mode</i> .

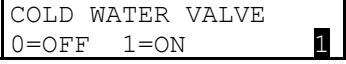
Table 10: E-P Express Outputs

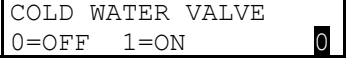
Output Number	Page-Column	Description	Device	MTA	Consequences of Actuation
1	0-a	Inject chemical 5	K1	5-2/5-11	Operates inject device for chemical 5
2	0-b	Inject chemical 1	K2	5-3/5-1	Operates inject device for chemical 1
3	0-c	Inject chemical 4	K3	5-4/5-1	Operates inject device for chemical 4
4	0-d	Inject chemical 3	K4	5-5/5-1	Operates inject device for chemical 3
5	0-e	Inject chemical 2	K5	5-6/5-1	Operates inject device for chemical 2
6	0-f	Hot water valve	K6	3-2/3-1	Opens valve
7	0-g	Cold water valve	K7	3-3/3-1	Opens valve
8	0-h	Drain solenoid	K8	3-4/3-1	Closes drain
9	0-i	Flush valve	K9	3-5/3-1	Opens flush valve
10	0-j	not used	K10	3-6/3-1	
11	0-k	not used	K11	3-7/3-1	
12	1-a	not used	K12	3-8/3-1	
13	1-b	not used	K13	3-9/3-1	
14	1-c	not used	K14	3-10/3-1	
15	1-d	not used	K15	3-11/3-1	
16	1-e	not used	K16	3-13/3-14	
16	1-e	Door lock	K16	3-13/3-14	
17	1-f	Unlock door	K17	3-15/3-16	Energizes door latch to unlocked position
18	1-g	not used	K18	3-18/3-17	
19	1-h	Extract speed (use only with empty cylinder)	K19	3-19/3-17	Locks door and turns cylinder at extract speed.
20	1-i	Distribution (drain) speed (Door must be closed)	K20	3-20/3-17	Locks door and turns cylinder at drain speed.
21	1-j	Clockwise wash speed (Door must be closed)	K21	3-21/3-17	Locks door and turns cylinder clockwise at wash speed.
22	1-k	Counter-clockwise wash speed (Door must be closed)	K22	3-22/3-17	Locks door and turns cylinder counter-clockwise at wash speed.
23	0	Buzz signal	Signal on board	none	Sounds operator alarm
24	0	Run light	Light on board	none	Turns on light in Start button (L)
25	0	Reversing wash speed	Functional test	none	Locks door and reverses cylinder at wash speed.
26	0	High extract speed	Functional test	none	Locks door and turns cylinder clockwise at wash speed, then high extract speed.
27	0	Fill to level 1	Functional test	none	Locks door, closes drain, fills to level 1 with cold water.
28	0	Fill to level 2	Functional test	none	Locks door, closes drain, fills to level 2 with cold water.

4.2.5. Testing and Verifying the DIP Switch Settings

For all E-P Express models, the set of default formulas is determined by how the DIP switches on the processor board are set. The bank of DIP switches is identified in [Figure 11](#).

Figure 11: Processor Board

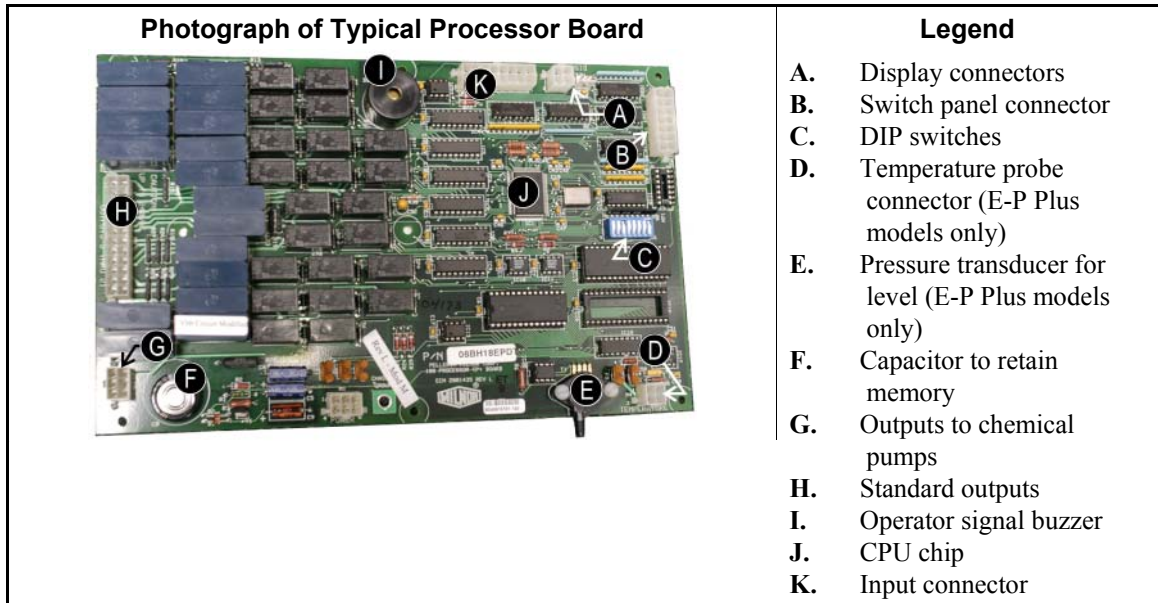

There is one unique number which identifies each possible combination of on/off settings at the DIP switch. While the industry configuration (switch 1 through switch 4) is readily available from the *Software version mode* (described in Section 4.2.2 “Determining the Software Version”), the settings of other switch positions are only apparent from this display or by visually inspecting the processor board.







Display or Action	Explanation
	Enters the <i>Manual menu</i> from the <i>Run mode</i> .
<div style="border: 1px solid black; padding: 2px;"> MANUAL MENU 1 SOFTWARE DATE CODE </div>	This is the first item of the <i>Manual menu</i> .
 , 	Scrolls down to the <i>Test DIP Switch</i> item.
<div style="border: 1px solid black; padding: 2px;"> MANUAL MENU 4 TEST DIP SWITCH </div>	This is the <i>Test DIP Switch</i> item of the <i>Manual menu</i> .
 + 	Accesses the <i>Test DIP Switch</i> function and displays the DIP switch setting.
<div style="border: 1px solid black; padding: 2px;"> 052 </div>	This is an example of the DIP switch display. Referencing this number in Table 11 shows that the sample machine is configured for Restaurants Laundry, and that switch positions 5 and 6 are enabled.
	Terminates the <i>Manual menu</i> and returns controller to <i>Run mode</i> .

Table 11: Interpretation of Test DIP Switch Display

Industry Configuration	Standard Display Value	Value if Position 5 is ON	Value if Position 6 is ON	Value if Both Positions 5 and 6 are ON
Correctional	0	16	32	48
Hotel/Motel	1	17	33	49
Athletic	2	18	34	50
Healthcare	3	19	35	51
Restaurants	4	20	36	52
Commercial	5	21	37	53
Shirt Laundry	6	22	38	54
Offshore	7	23	39	55
Fire-Fighter	8	24	40	56

4.2.6. Viewing Inputs and Outputs while Machine is Operating

While the machine must be idle to actuate outputs, inputs and outputs can be viewed (but not turned on or off) while the machine is operating.

Display or Action

```
23:04 F02S01 02:37
L=A1/D1 Hot Wash
```

Explanation

This is a typical display while the machine is running a formula.

1 + **▲**

displays the inputs. A plus sign (+) indicates the input is grounded, while a minus sign (-) indicates the input is not grounded.

```
ABCDEFGHIJK
+++-----
```

typical display of input status while the machine is running. Refer to [Table 10](#) to determine which input is represented by each character on the display.

11 + **▲**

displays the first 11 outputs (Page 0). A plus sign (+) indicates the output is actuated, while a minus sign (-) indicates the output is turned off.

11 + **▼**

displays the last 11 outputs (Page 1).

```
PAGE abcdefghijk
0 -+-----
```

typical display of first page of outputs (Page 0) while the machine is running. Refer to [Table 10](#) to determine the component represented by each character on Page 0 and Page 1.

— End of BICJHT03 —

Chapter 5



Supplemental Information

BICJUF01 (Published) Book specs- Dates: 20070531 / 20070531 / 20070531 Lang: ENG01 Applic: CJX

5.1. The E-P Express[®] Hardware

The Milnor[®] E-P Express[®] microprocessor control is designed specifically for Milnor[®] washer-extractors. Along with certain external electromechanical relay logic and sensing devices, it controls all machine and system functions. Not every Milnor[®] microprocessor system includes all the following components.

5.1.1. Keyswitches

5.1.1.1. Run/Program Keyswitch—This keyswitch allows controlling who has the necessary access to modify wash formulas. Formulas can be modified only when this switch is turned from the *Run* position () to the *Program* position (). To safeguard wash formulas, keep this key in a secure place with restricted personnel access.

5.1.1.2. Automatic/Test Keyswitch—E-P Express models are not equipped with an *Automatic/Test* keyswitch.

5.1.2. Display

Machines with the E-P Express[®] control use a vacuum fluorescent display consisting of two lines of 20 characters each. This type of display is easily identified by green characters on a black background when operating, or a nearly black background when not operating.

5.1.3. Power Supply

The power supply serves to provide a regulated specific voltage to the processor board and certain auxiliary boards and devices. It converts control circuit alternating current voltage to +12 volts direct current, -12 volts direct current, and +5 volts direct current. The power supply is switchable between 120 volts and 240 volts alternating current input voltage.

Although the +12VDC and -12VDC are not adjustable, the +5VDC is rather sensitive and the power supply must be adjusted so **the actual voltage at the processor board is between 5.04VDC and 5.06VDC** as measured by an accurate digital voltmeter. If this voltage is not within the stated range, the machine is likely to malfunction.

5.1.4. CPU Processor Board

The central processing unit (CPU) processes data received from the various inputs, stores information, and responds to each pushbutton entry with the appropriate action. Data is stored in

one or more of the following types of memory chips on the CPU board, depending on the machine model.

SRAM—Static Random Access Memory stores the accumulator (formula count) data as long as the machine has power, or via a capacitor for approximately 24 hours with power off. This type of component is also used to retain the last formula and step in progress when power is turned off at the machine while a formula is running. SRAM is used in all E-P Plus® and E-P Express® controllers.

Flash Memory—Similar to EEPROM memory in function, **flash memory** can be electrically erased and reprogrammed, but is faster and can retain more data than EEPROM memory. Flash memory is used on processor boards for F_J, H_J, X_J, and V_J models, as well as all E-P Express® models. The two flash memory chips reside in sockets IC2 and IC12. The chip in socket IC12 contains operating instructions and the complete set of industry standard formulas. As software updates are made available, the owner/operator may choose to replace this chip. The chip in socket IC2 holds the industry formulas and user changes to those formulas, as well as machine configuration data. The chip in socket IC2 will not normally need replacing for software updates.

5.1.5. Outputs

Depending on the processor board, output relays may be either socket-mounted to a separate output board, or permanently soldered to the processor board.

Machines in the E-P Express® model lines use the 188 processor board with output relays soldered to the processor board. These relays are SPST (single pole, single throw) with contacts capable of faithfully conducting a maximum of 25VA. The output voltage is usually 220/240VAC.



WARNING 26: Avoid damage to electronic boards—Although the relays on 188 processor boards are capable of handling higher loads, failure to restrict current loads to the values stated above may cause traces on the processor board to fail, thus destroying the board.

5.1.6. Option Outputs

E-P Express® models are not equipped with option outputs.

5.1.7. Analog to Digital Convertor

An analog to digital convertor is not necessary on E-P Express® models, which do not use analog signals for temperature or level.

5.1.8. Temperature Probe

Temperature control is not offered on E-P Express® models.

5.1.9. Pressure Sensor

E-P Express® models employ electro-mechanical pressure switches to detect the water level in the cylinder.

— End of BICJUF01 —

BICUDC01 (Published) Book specs- Dates: 20070531 / 20070531 / 20070531 Lang: ENG01 Applic: CJX

5.2. Serial Memory Storage Device Applications

A serial memory storage device similar to one shown below can be used to store machine configuration and formula data for most current models of Milnor® machines. DIP switches inside

the storage device allow you to configure the device to accept data from several different machine types and software versions. Use this document to determine the proper DIP switch setting for your machine. After verifying the switch settings, label the storage device with the date, machine name, and serial number to avoid confusion when the device is needed to restore data to a machine.

Figure 12: Serial Memory Storage Device

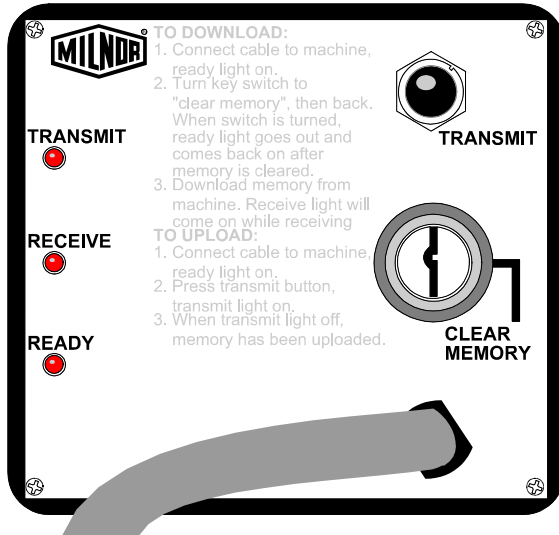

Figure 13: Rear View of Circuit Board

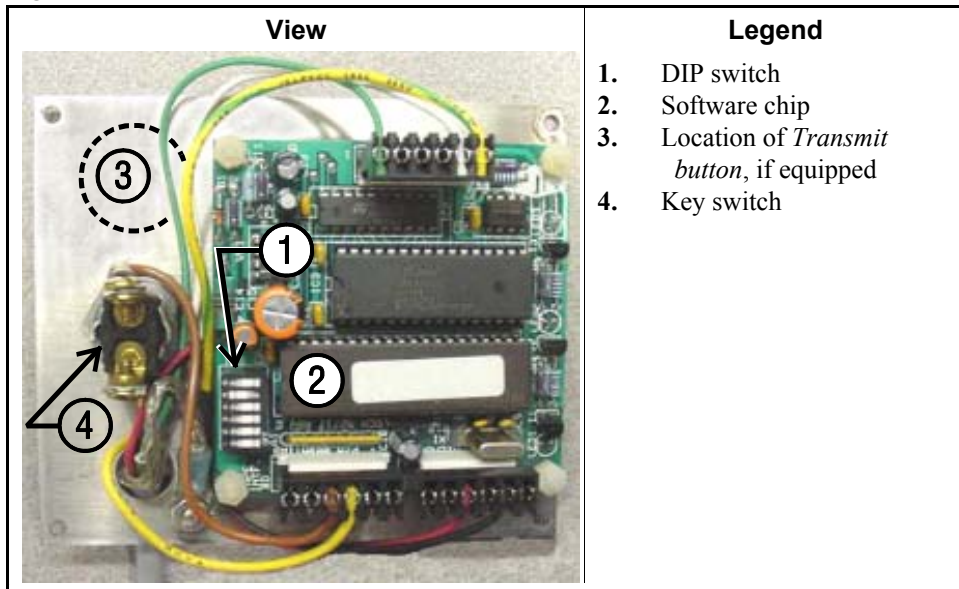

Table 12: DIP Switch Positions for Use with E-P Plus and E-P Express Machines (External Transmit Button Required)

Processor Board Part Number	Processor Board Revision Code	Machine Software and Revision	Storage Device Software and Revision	DIP Switch Setting
30015HxJ and 30022HxJ Models				
08BH18EPDT	K	WUH7JA/2200E	WUNTIA/00008	E
VxJ Models				
08BH18EPDT	K	WUV7J1B/2200K	WUNTIA/00008	E
30015T5X and 30022T5X Models				
08BH18EPYT	K	WUEPXRSA/22004	WUNTIA/00008	E
All E-P Express Gear Guardian Models				
08BH18EPYT	K	WUT5XGGA/22GGF	WUNTIA/00008	E
Key:				
A	All switch positions OFF			
B	Position 4 ON; all others OFF			
C	Position 5 ON; all others OFF			
D	Positions 1 and 5 ON; all others OFF			
E	Positions 4 and 5 ON; all others OFF			

— End of BICUDC01 —

BICWUC01 (Published) Book specs- Dates: 20070531 / 20070531 / 20070531 Lang: ENG01 Applic: CJX

5.3. Construction of External Serial Link Cables

This document provides information for on-site fabrication of certain types of serial communication cables. Programmable data can be transferred between compatible machines or between a machine and a Milnor serial memory storage device (see [Note 8](#)), using the download cables described in [Section 5.3.2.2](#) and [Section 5.3.2.3](#) respectively. These cable(s) connect to the cabinet-mounted 9-pin DIN type receptacle shown in [Figure 14](#) and may be installed temporarily or permanently, as appropriate.

Note 7: The currently approved printers and printer configuration settings are provided in the related section in document BICWUI01. A pre-assembled machine-to-printer cable similar to the cable described here, is available from Milnor (P/N 10YMK2PNTR).

Note 8: The Milnor serial memory storage device (also known as a download box) contains nonvolatile memory to hold a back-up copy of the programming and configuration data for **one machine**. This data is transferred between the machine and the memory storage device via the DIN receptacle on the machine. Two models are currently available: KXMIC00507 and KXMIC00508. The already wired cable and DIN connector are included as part of the memory storage device. Consult the Milnor Service department to determine the correct device for a particular application.

5.3.1. Pin Identification

[Figure 14](#) illustrates the DIN receptacle (which uses male pins) and the mating plug (which uses female pin sockets), each viewed from the **wire entry** side. The receptacle is normally installed and wired at the Milnor factory. The plug and female pin sockets for customer use are provided in a bag inside the electric box. [Table 13](#) shows the function of each pin.

Figure 14: 9-Pin DIN Connector Pin Identification (from wire entry side of connectors)

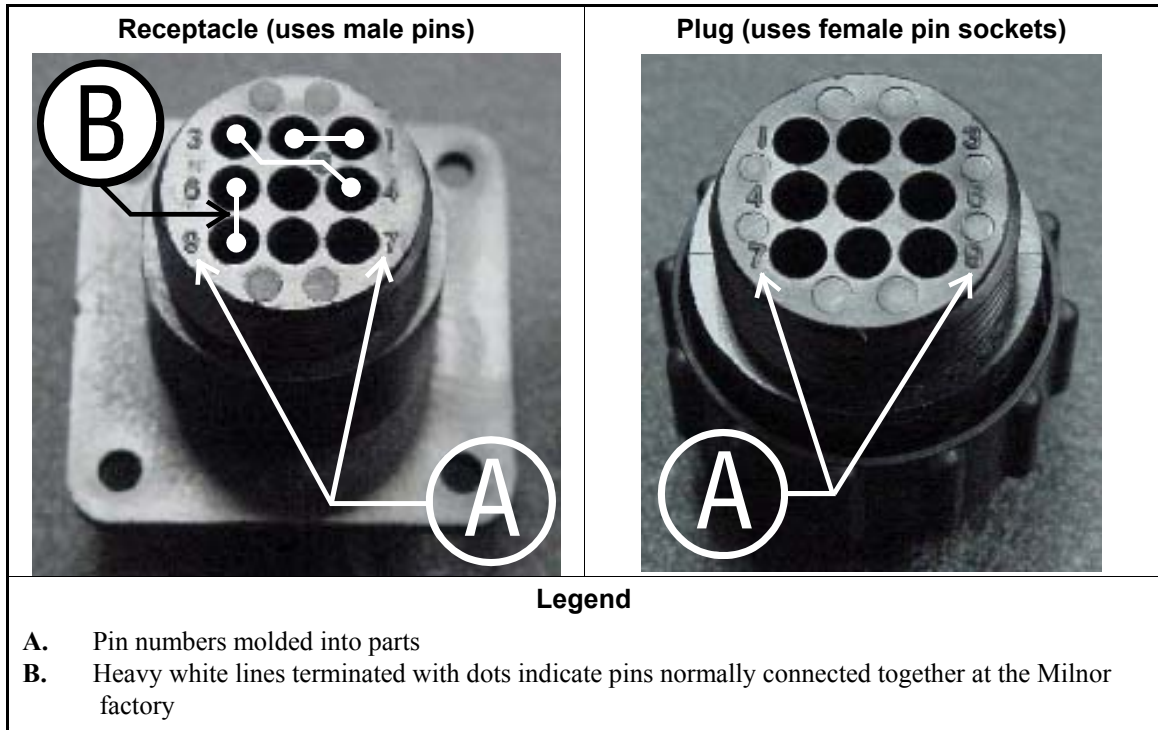

Table 13: External Serial Link Pin Assignments

Pin Number	Function	Receptacle Wiring (inside electrical enclosure)	
		Wire Number	Color Code
1	Serial low	DLL	Blue and black
2			
3	Serial high	DLH	Blue and red
4			
5	Clear to send (not used on these models)	CTS	Blue and orange
6	Electronic ground	2G	Blue and white
9			
7	Transmit data (not used on these models)	TXD	Blue and orange
8	+5 volts DC (used for serial memory storage device only)	V1	Blue



CAUTION [27]: Risk of damage to electronic components—Pin 8 is only used to supply +5VDC power to the download box and will damage components in both devices if not properly connected

- Never connect pin 8 to any other pin in the connector, a printer, or another machine.

5.3.2. How to Wire the Cables

Because the DIN receptacle is wired to support different functions and because the data transferred across these cables can be corrupted by electrical noise, follow these instructions carefully.

5.3.2.1. Cable Specifications—Multi-conductor shielded cable that meets the following minimum requirements must be used in the applications covered herein. Conforming cable may be purchased from Milnor (P/N 09V300A04S) or purchased from another source:

- Jacket: 600VAC insulation
- Shielding: braided, tinned copper, minimum 85 percent coverage
- Four conductors with these specifications:
 - » Conductive material: Tinned copper, 20 AWG
 - » Insulation: 300VAC, color coded
 - » Preferred colors: red, black, green and white

5.3.2.2. Connecting Two or More Machines for Machine-to-machine Transfer—Figure 15 shows how to wire a cable to connect a bank of identical machines (the Figure 15 example shows connections for four machines) so that data programmed on one machine in the group can be downloaded to all other machines simultaneously. This cable is referred to as a daisy chain because it runs in segments from machine to machine, connecting all machines in the group.

Figure 15: Wiring Diagram for Cable to Connect Two or More Machines

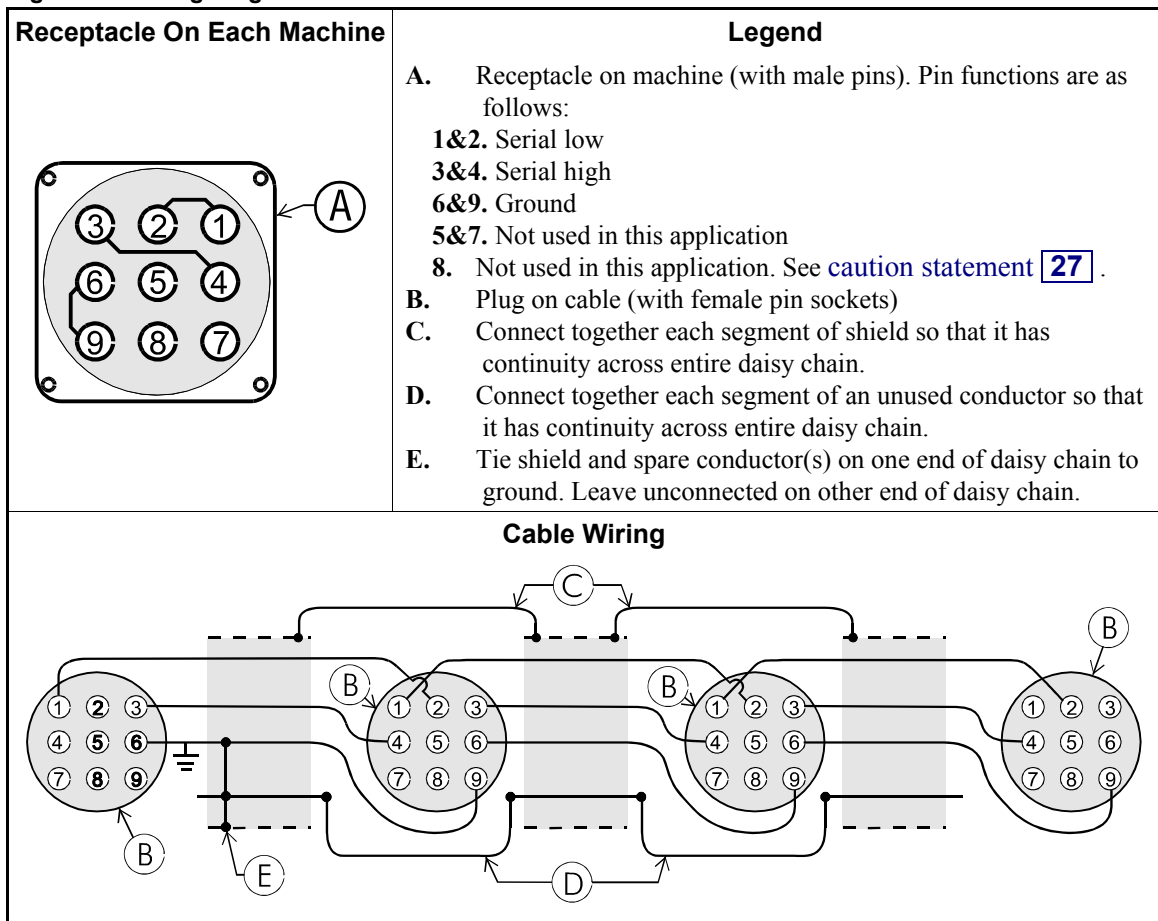

The internal connections on each receptacle (machine) between pins 1 and 2, 3 and 4, and 6 and 9 make it easier to wire the cable because it is not necessary to jumper these pins together on the cable. However, this also means that every plug on the daisy chain must be plugged into a receptacle. Otherwise, the serial low, serial high, and ground conductors will not have continuity across the entire daisy chain and some machines will not receive data.

Rules and details about downloading among machines are fully described in the programming section of the reference manual.

5.3.2.3. Connecting a Machine to a Serial Memory Storage Device—The cable used with the serial memory storage device (download box) available from Milnor, see [Note 8](#), is permanently attached to the storage device. Cable fabrication, as shown in [Figure 16](#), is not required except for replacing a damaged cable. The memory storage device is the only application in which the power conductor (Pin 8) is used.

Figure 16: Wiring Diagram for Cable to Connect a Machine to a Serial Memory Storage Device

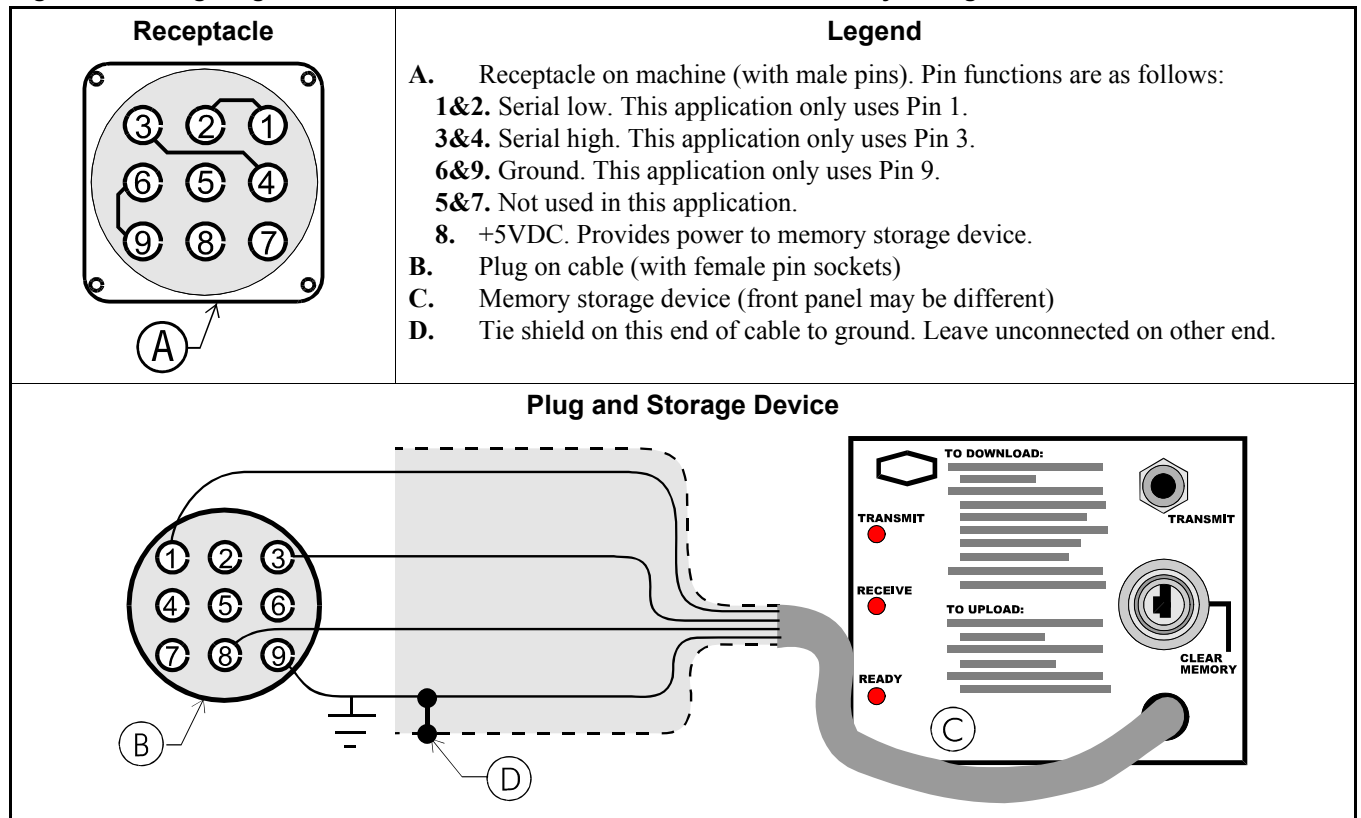

— End of BICWUC01 —