

Water Specialist EA Control Valve Programming and Cover Drawing Manual

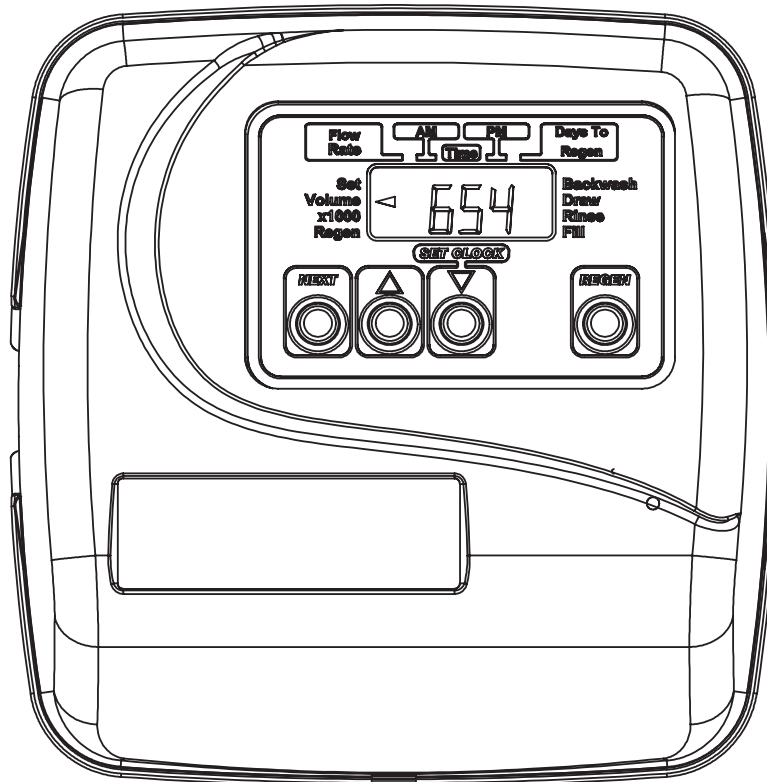

Table of Contents

EA Front Cover and Drive Assembly	4
Regeneration and Error Screens, Button Operations and Functions.....	5
User Displays	6
Configuration Settings	7
Setting Regeneration Cycle Times.....	11
Installer Display Settings	12
Diagnostics.....	14

EA Front Cover and Drive Assembly

Drawing No.	Order No.	Description	Quantity
1	V3175EE-01	WS1EE FRONT COVER ASSEMBLY	1
2	V3107-01	WS1 MOTOR	1
3	V3106-01	WS1 DRIVE BRACKET & SPRING CLIP	1
4	V3408EA-03BOARD	WS1THRU2L/2 EAPCBRD MAV/ALT REPL	1
5	V3110	WS1 DRIVE GEAR 12X36	3
6	V3109	WS1 DRIVE GEAR COVER	1
Not Shown	V3186	WS1 AC ADAPTER 120V-12V	1
	V3186-01	WS1 AC ADAPTER CORD ONLY	
Not Shown	V3178	WS1 Drive Back Plate	1

Refer to Control Valve Service Manual for other drawings and part numbers.

AC Adapter	U.S.	International
Supply Voltage	120 V AC	230V AC
Supply Frequency	60 Hz	50 Hz
Output Voltage	12 V AC	12 V AC
Output Current	500 mA	500 mA

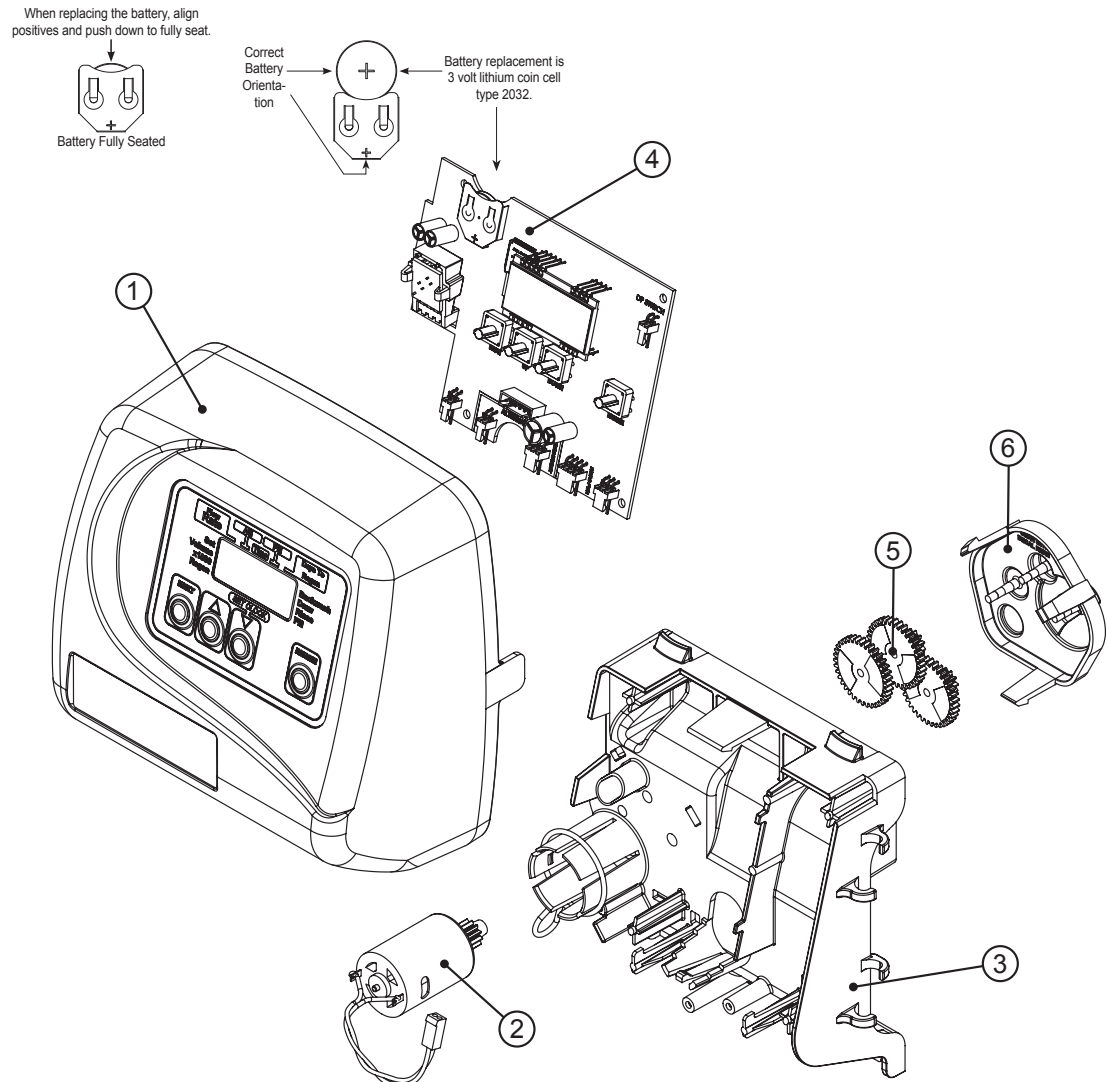

Regeneration and Error Screens

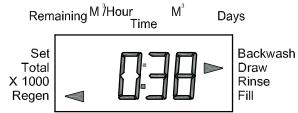

Regen Screen

Displays the time remaining in the current cycle. Pressing REGEN advances to the next cycle.

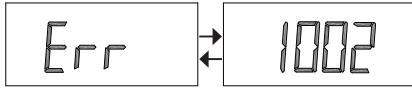

Error Screen

Alternated flashing Err and error code every 3 seconds. Clear by disconnecting the power supply at the PC board and reconnecting, or press NEXT and REGEN simultaneously for 3 seconds.

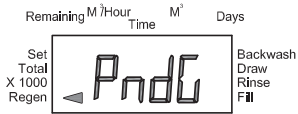

In Alternator Systems when a unit is waiting to initiate the first cycle step of regeneration, “REGEN PndG” is displayed.

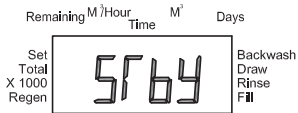

“STbY” is displayed in Alternator Systems when a valve is in Standby state.

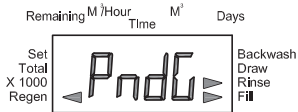

“REGEN PndG RINSE FILL” is displayed whenever a zero-capacity tank has transferred to an off-line state and is currently waiting to initiate the second portion of a regeneration cycle. Viewed only when Delayed Rinse and Fill is set to ON.

Button Operation and Function



Scrolls to the next display.

Pressing once and releasing will schedule a regeneration at the preset delayed regeneration time.



Pressing again and releasing will cancel the regeneration.

Pressing and holding for 3 seconds will initiate an immediate regeneration

Pressing while in regeneration will advance to the next cycle.

Pressing in the program levels will go backwards to the previous screen



Changes variable being displayed.



Key sequence to lock and unlock program settings.



Holding for 3 seconds initiates a control reset. The software version is displayed and the piston returns to the home/service position, resynchronizing the valve.



Used with valve type 1.0T, holding for at least 3 seconds causes a switch in the tank in Service without cycling the regeneration valve. After tank switch, days remaining and capacity remaining status is retained for each tank until the next regeneration.

Regeneration Cycles and Times

Cycle	Range of times (min.)
1. Backwash 1 st (upflow)	1 - 95 or OFF
2. Regenerant Draw/Slow Rinse (downflow)	1 - 180 or OFF
3. Backwash 2 nd (upflow)	1 - 95 or OFF
4. Fast Rinse (downflow)	1 - 95 or OFF
5. Regenerant Refill (with treated water)	0.1 - 99.9 or OFF
6. Service (downflow)	

The user can initiate manual regeneration. The user has the option to request the manual regeneration at the delayed regeneration time or to have the regeneration occur immediately:

1. Pressing and releasing the REGEN button. “◀” will flash towards Regen on the display and the regeneration will occur at the delayed regeneration time. The user can cancel the request by pressing and releasing the REGEN button.
2. Pressing and holding the REGEN button for approximately 3 seconds will immediately start the regeneration. The user cannot cancel this request, except by resetting the control by pressing NEXT and REGEN simultaneously for 3 seconds.

User Displays

General Operation

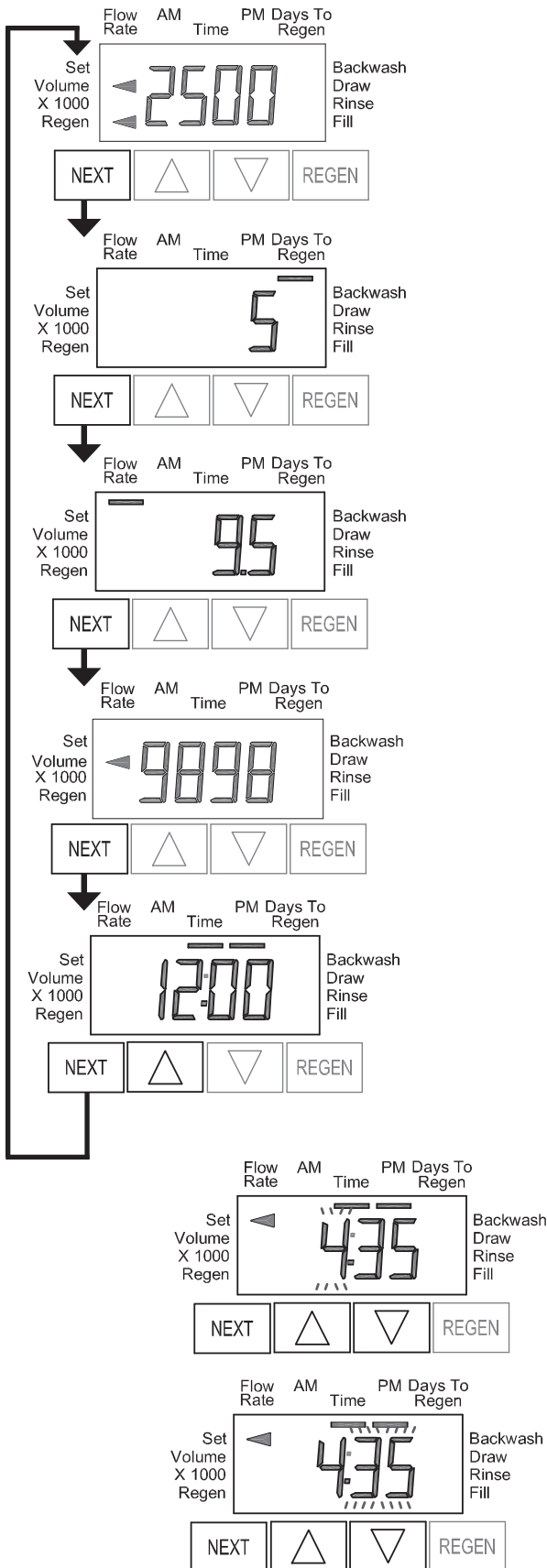

When the system is operating, one of five displays may be shown. Pressing NEXT will alternate between the displays shown below.

User 1

Typical user display. If volume is selected in Configuration Settings Step 4CS, shows volume remaining to regeneration. If volume is not selected in Configuration Settings Step 4CS, this screen will not be shown. If a meter is not used this display will not change.

User 2

Displays number of days to next regeneration.

User 3

Displays flow rate in gallons per minute. If a meter is not used this display will be shown but 0 will be displayed. If 1.0 Γ is selected in Step 2CS an “A” in front of the flow rate indicates that the tank with the control valve on it is in service. If “b” is displayed the tank with the in/out head is in service. This screen will not be shown if 7 day or 28 day is selected in Configuration Settings Step 4CS.

User 4

Displays total flow in gallons since last reset. If a meter is not used this display will be shown but 0 will be displayed. This screen will not be shown if 7 day or 28 day is selected in Configuration Settings Step 4CS.

PRESS ▼ FOR 3 SECONDS TO RESET TO 0.

User 5

Shows current time.

Setting Time of Day

Push NEXT until time of day screen is displayed. Press and hold ▲ or ▼ until the SET indicator is displayed, and the hour flashes. Press ▲ or ▼ until the correct hour is displayed.

Then press NEXT. The minutes will flash. Press ▲ or ▼ until the correct minute is displayed.

Press NEXT to return to the Display Screens. Time of day should only need to be set after power outages lasting more than 8 hours, if the battery has been depleted and a power outage occurs, or when daylight saving time begins or ends. If a power outage lasting more than 8 hours occurs, the time of day will flash on and off which indicates the time of day should be reset. If a power outage lasts less than 8 hours and the time of day flashes on and off, the time of day should be reset and the battery replaced.

Configuration Settings

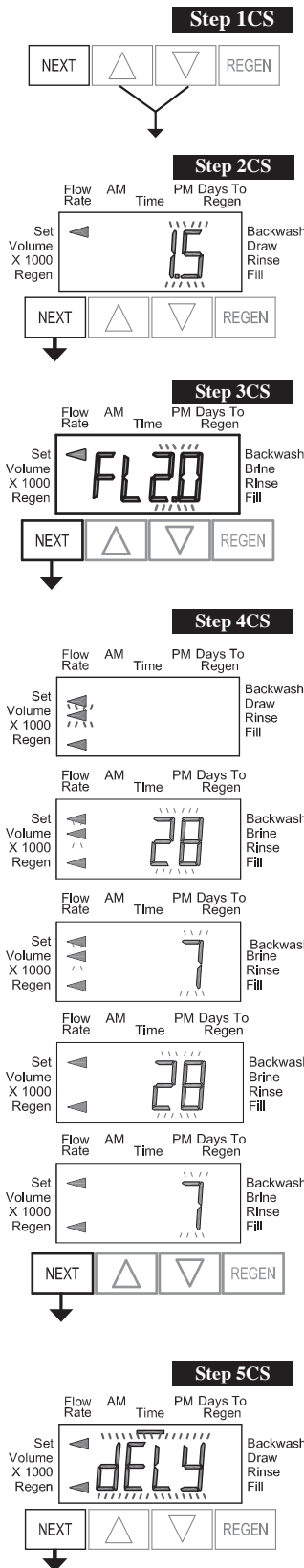

Step 1CS – Press ▲ and ▼ simultaneously for 5 seconds and release. If screen in Step 2CS does not appear, the lock on the valve is activated. To unlock press ▼, NEXT, REGEN, ▲ in sequence, then press ▲ and ▼ simultaneously for 5 seconds and release.

Step 2CS – Choose 1.0 for 1”, 1.25 for 1.25”, 1.5 for 1.5”, 2.0L for 2L, 2.0 for 2” valve¹, 1.0Γ for 1” twin valve².

Press NEXT to go to Step 3CS. Press REGEN to exit Configuration Settings.

Note: When using the WS2 valve, if “2L” is set instead on “2.0” for valve type, when the valve is in regeneration and the piston drives to the “Draw” cycle the piston will stall and generate a 1002 error code. Clear error code by pressing “NEXT” and “REGEN” simultaneously until the valve resets, then re-program to proper valve type setting.

Step 3CS – When 2.0L or 2.0 are selected, an additional screen will appear. It is used to select which size flow meter is to be used with the valve, 1.5 or 2.0.

Press NEXT to go to Step 4CS. Press REGEN to return to previous step.

Step 4CS – Press ▲ or ▼ to select one of the following:

- If Volume (gallons) is selected the regeneration will occur after the specific volume has been used or on the day override (if selected) whichever comes first.
- If 28/Volume (gallons) is selected the regeneration will occur on the day (1 through 28) selected in Installer Display Settings. If a meter is not used the total flow and flow rate user displays and the volume display in Diagnostics will be shown as 0.
- If 7/Volume (gallons) is selected the regeneration will occur on the selected day(s) of the week (see instructions contained in Installer Display Settings). If a meter is not used the total flow and flow rate user displays and the volume display in Diagnostics will be shown as 0.
- If 28 is selected the regeneration will occur on the day (1 through 28) selected in Installer Display Settings. The total flow and flow rate user displays and the volume display in Diagnostics will not be shown even if a meter is used.
- If 7 is selected the regeneration will occur on the selected day(s) of the week (see instructions contained in Installer Display Settings). The total flow and flow rate user displays and the volume display in Diagnostics will not be shown even if a meter is used.

Press NEXT to go to Step 5CS. Press REGEN to return to previous step.

Step 5CS – Press ▲ or ▼ to select to regenerate immediately on 0 or at delayed time. Immediately on 0 can only be selected if Volume (gallons) was selected in step 4CS and a meter must be installed. Delay is the only option for the other Step 4CS selections. Press NEXT to go to Step 6CS. Press REGEN to return to previous step.

¹ When using the WS2 control valve, the circuit board software must have meter selection choices of 2.0 and 2.0L. The WS2 valve must be set for the 2.0 meter selection during programming. If the software version does not have both the 2.0 and 2.0L selections, consult your equipment supplier for a replacement circuit board. When using the WS2L valve with older version software that does not have both 2.0 and 2.0L selection choices, the valve must be set to 2.0 during programming. If a WS2L valve is being used with newer version software that has both 2.0 and 2.0L selection choices, the valve must be set to 2.0L during programming.

² For software rev 700.8 or higher.

Step 6CS

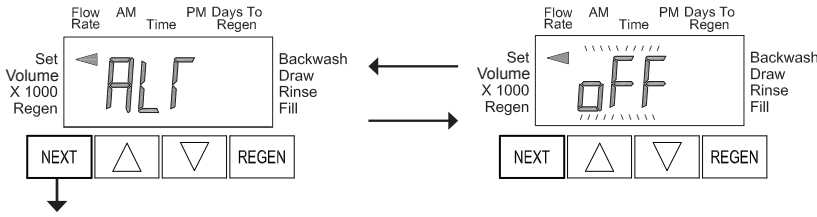

Step 6CS – This display will not appear if 1.0 Γ was selected in Step 2CS. Allows selection of one of the following using ▲ or ▼:

- the Control Valve to have no hard water bypass;
 - the Control Valve to act as an alternator;
 - the Control Valve to have a separate source during the regeneration cycle; or
 - the Control Valve to act as a single valve twin alternator.
- Select OFF when none of these features are used.

Only use Clack No Hard Water Bypass Valves or Clack Motorized Alternating Valves (MAV) with these selections. Clack No Hard Water Bypass Valves (1” or 1.25” V3070FF or V3070FM) are not designed to be used with the alternator or separate source functions. The V3063 and V3063BSPT motorized alternating valves are not designed to be used as a no hard water bypass or separate source inlet if the pressure differential is more than 60 psi.

Configuring the Control Valve for No Hard Water Bypass Operation:

Select nHbP for control operation. For no hard water bypass operation the three wire connector is not used.

Selection requires that a connection to MAV or a Clack No Hard Water Bypass Valve is made to the two pin connector labeled ALTERNATOR DRIVE located on the printed circuit board. If using a MAV, the A port of the MAV must be plugged and the valve outlet connected to the B port. When set to nHbP the MAV will be driven closed before the first regeneration cycle that is not FILL or SOFTENING or FILTERING, and be driven open after the last regeneration cycle that is not FILL.

NOTE: If the control valve enters into an error state during regeneration mode, the no hard water bypass valve will remain in its current state until the error is corrected and reset.

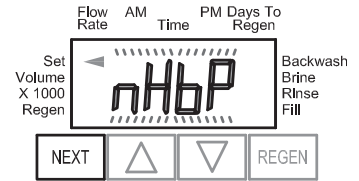

Configuring the Control Valve for Separate Source Operation:

Select SEPS for control operation. For separate source operation the three wire connector is not used.

Selection requires that a connection to a Clack Motorized Alternator Valve (MAV) is made to the two pin connector labeled ALTERNATOR DRIVE located on the printed circuit board. The C port of the MAV must be connected to the valve inlet and the A port connected to the separate source used during regeneration. The B port must be connected to the feed water supply.

When set to SEPS the MAV will be driven closed before the first regeneration cycle, and be driven open after the last regeneration cycle.

NOTE: If the control valve enters into an error state during regeneration mode, the MAV will remain in its current state until the error is corrected and reset.

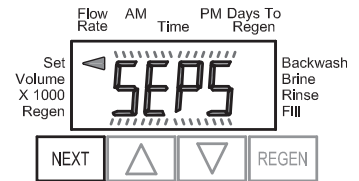

Selecting the Control Valve to act as an alternator:

700.1 and higher = Use 3-wire Interconnect Cables for all communication between units.

516.7 and lower = Use 2-wire Interconnect Cables for twin alternators with independent flow meters.

Prior to starting the programming steps, connect the interconnect cable to each control valve board’s three pin connector labeled “INTERCONNECT”. Also connect the meter cord to either control valve to the three pin connector labeled “METER”.			
Valve Programming Steps			
Configuration Settings	Step 4CS	Select Volume	Set Volume
Configuration Settings	Step 5CS	Set regeneration time option to “On O”.	Set regeneration time option to “On O”.
Configuration Settings	Step 6CS	Set to ALTA Connect ALTA valve to the MAV’s A port and connect the MAV’s two pin wire connector to the two pin connector labeled “DRIVE” on the ALTA valve	Set to ALTb Connect ALTb valve to the MAV’s B port. No connections between the ALTB valve and the MAV are made.
Installer Display Setting	Step 2I	Enter the Volumetric Capacity for the System	Enter the Volumetric Capacity for the System (the same as Valve A)
Installer Display Setting	Step 3I	Set Day Over ride to “oFF”	Set Day Over ride to “oFF”

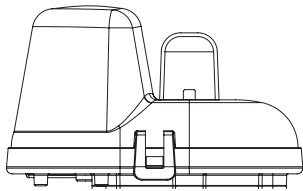

Retracted

Valve "A" in Service Position = MAV piston rod Retracted

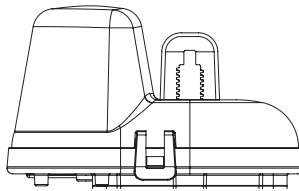

Extended

Valve "B" in Service Position = MAV piston rod Extended

For Clack Corporation alternator systems using WS1, WS1.25, WS1.5, and WS2L valves there will be an option to delay the last two cycles of regeneration (only "Rinse" and "Fill"). This feature splits the regeneration into two portions. The first portion of the regeneration will start immediately and all programmed cycles before the "Rinse" and "Fill" cycles will be performed. After all programmed cycles before "Rinse" and "Fill" are completed the control valve will drive to the service position (displaying "Delayed Rinse + Fill Pending"). When the volume of the on-line unit is depleted to 10% of its programmed capacity, the control valve will be triggered to finish the second portion of the regeneration and complete the "Rinse" and "Fill" cycles and return to Service and be placed into Standby mode, and wait to come on-line for service.

For Clack Corporation alternator systems using the WS2 valve, when NEXT is pressed after selecting ALTA or ALTB, a display will allow the user to set the amount of pre-service rinse time for the stand by tank just prior to returning to service.

NOTE: Clack twin alternators can be set up to operate with a day over-ride setting in conjunction with the main volume based regeneration setting. If a system is programmed for twin alternating with a delayed regeneration, a Clack twin alternator can perform an immediate transfer of the MAV to place a fully regenerated tank on-line and have a delayed regeneration time for the exhausted unit. Clack twin alternators will only count days on the unit that is on-line which will allow the twin alternating system to regenerate based on only a day over-ride setting when programmed to regenerate based on days.

WS1, WS1.25, WS1.5, WS2L Valves

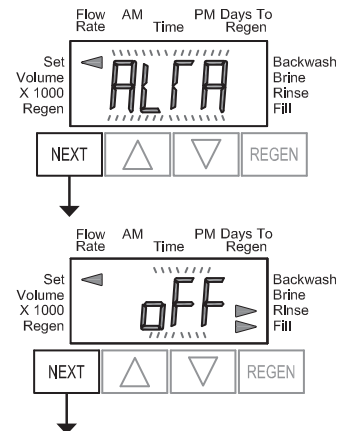

WS2 Valve

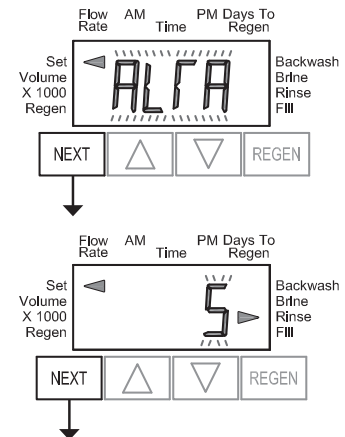

Selecting the Control Valve to act as a single valve twin alternator

Select 2T for control operation.

In step 4CS make sure to select Volume. In step 2I set the volumetric capacity in gallons to regeneration for a single tank. In step 3I set day override to OFF.

With these settings the system will regenerate when the meter records the gallons set in step 2I has gone through one tank.

The flow rate display (See User 3) will indicate an "A" in front of the flow rate to indicate that the tank with the control valve on it is in service. If "b" is displayed the tank with the in/out head is in service.

Press NEXT to go to Step 7CS. Press REGEN to return to previous step.

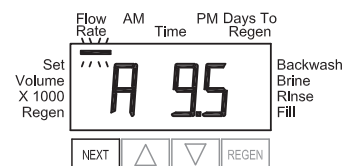
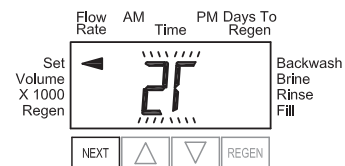

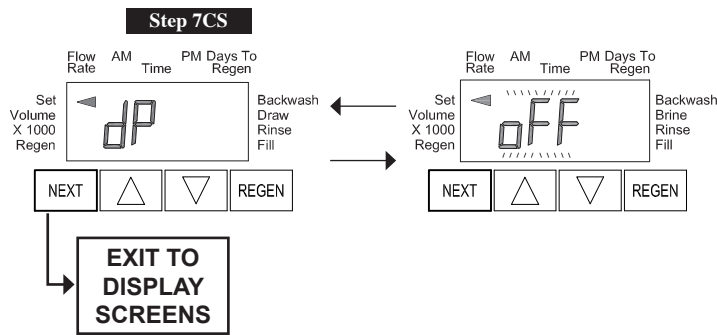

Step 7CS

Selecting the use of an outside signal to initiate a regeneration: Selection only matters if a connection is made to the two pin connector labeled DP SWITCH located on the printed circuit board. Following is an explanation of the options:

oFF - Feature not used.

NOTE: In a twin alternating system each control must have a separate dP signal or dP switch. One dP signal or one dP switch cannot be used for both controls.

on0 – If the dP switch is closed for an accumulative time of 2 minutes a regeneration will be signaled to the unit. In a twin alternating system the MAV will transition first to switch units so that the signaled unit can start regeneration. After the MAV has fully transitioned, the regeneration begins immediately. Note: For WS1 – WS2L control valves programmed for twin alternating: if the dP function “on0” is set, the Delayed Rinse and Fill feature is not available.

dELy – If the dP switch is closed for an accumulative time of 2 minutes a regeneration will occur at the scheduled delayed regeneration time. In a twin alternating system once the dP switch is triggered the PC Board will display “REGEN TODAY” and when the delayed regen time comes the control will switch tanks and the triggered unit will then go into regeneration. Note: For WS1 – WS2L control valves programmed for twin alternating: if the dP function “dEL” is set, the Delayed Rinse and Fill feature is not available.

HoLd – If the dP switch is closed a regeneration will be prevented from occurring while there is switch closure. In a twin alternating system the regeneration of a unit can be prevented upon switch closure. If the unit depletes the capacity down to zero, it will not be allowed to switch tanks to regenerate until the switch is open. Note: For WS1 – WS2L control valves programmed for twin alternating the Delayed Rinse and Fill feature can be set in conjunction with the “HoLd” if desired.

Press NEXT to exit Configuration Settings. Press REGEN to return to previous step.

Setting Regeneration Cycle Times

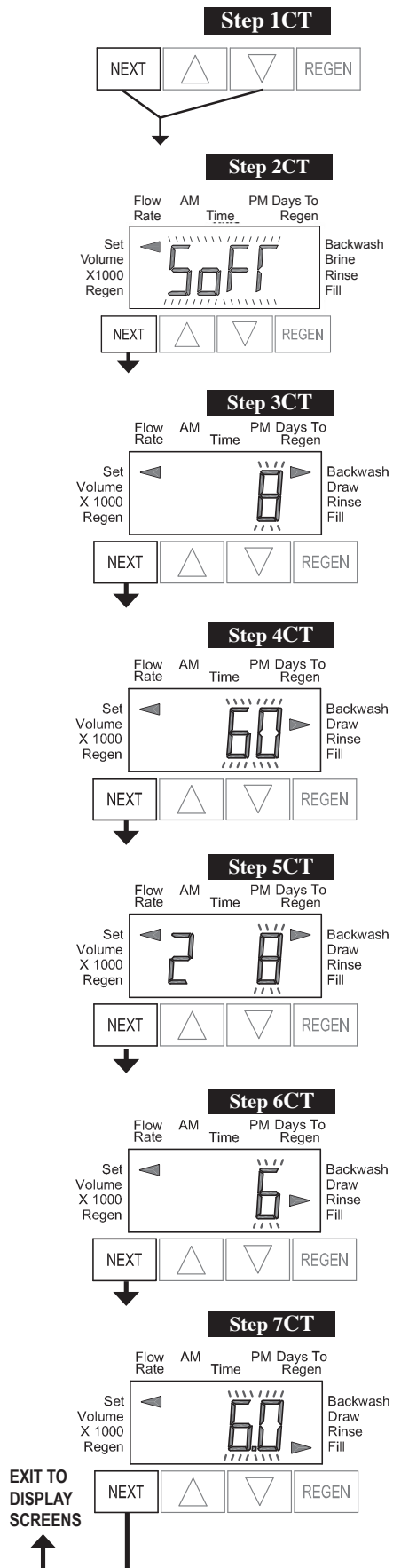

Step 1CT - Press NEXT and ▼ simultaneously for 5 seconds and release. If screen in Step 2CT does not appear, the lock on the valve is activated. To unlock press ▼, NEXT, REGEN, ▲ in sequence, then press NEXT and ▼ simultaneously for 5 seconds and release.

Step 2CT - Select between SOFTENING or FILTERING. When set to FLTr, 7CT is not set to off, and 2CS is set to 1.0, a fixed 30 second Backwash is automatically added to the regen cycle program after Rinse 6CT. The status display for this extra backwash will appear as just another cycle step in sequence. Press NEXT to go to Step 3CT. Press REGEN to exit Regeneration Cycle Times.

Step 3CT - Adjust the length of the backwash from 1-95 minutes or OFF using ▲ or ▼. Press NEXT to go to Step 4CT. Press REGEN to return to previous step.

Step 4CT - Adjust the length of the regenerant draw from 1-180 minutes or OFF using ▲ or ▼. Press NEXT to go to Step 5CT. Press REGEN to return to previous step.

Step 5CT - Adjust the length of the second backwash from 1-95 minutes or OFF using ▲ or ▼. Press NEXT to go to Step 6CT. Press REGEN to return to previous step.

Step 6CT - Adjust the length of rinse from 1-95 minutes or OFF using ▲ or ▼. Press NEXT to go to Step 7CT. Press REGEN to return to previous step.

Step 7CT - Adjust the length of fill from 0.1-99.0 minutes or OFF. WS2 valves are shipped from the factory with a refill flow control of 2.2 gpm (8.3 lpm). All other control valves are shipped from the factory with a refill flow control of 0.5 gpm (1.9 lpm). Press NEXT to exit Regeneration Cycle Times. Press REGEN to return to previous step.

Installer Display Settings

One of three sets of displays will be shown depending on what was selected in Configuration Settings Step 4CS.

Volume (Gallons) selected in Configuration Settings Step 4CS

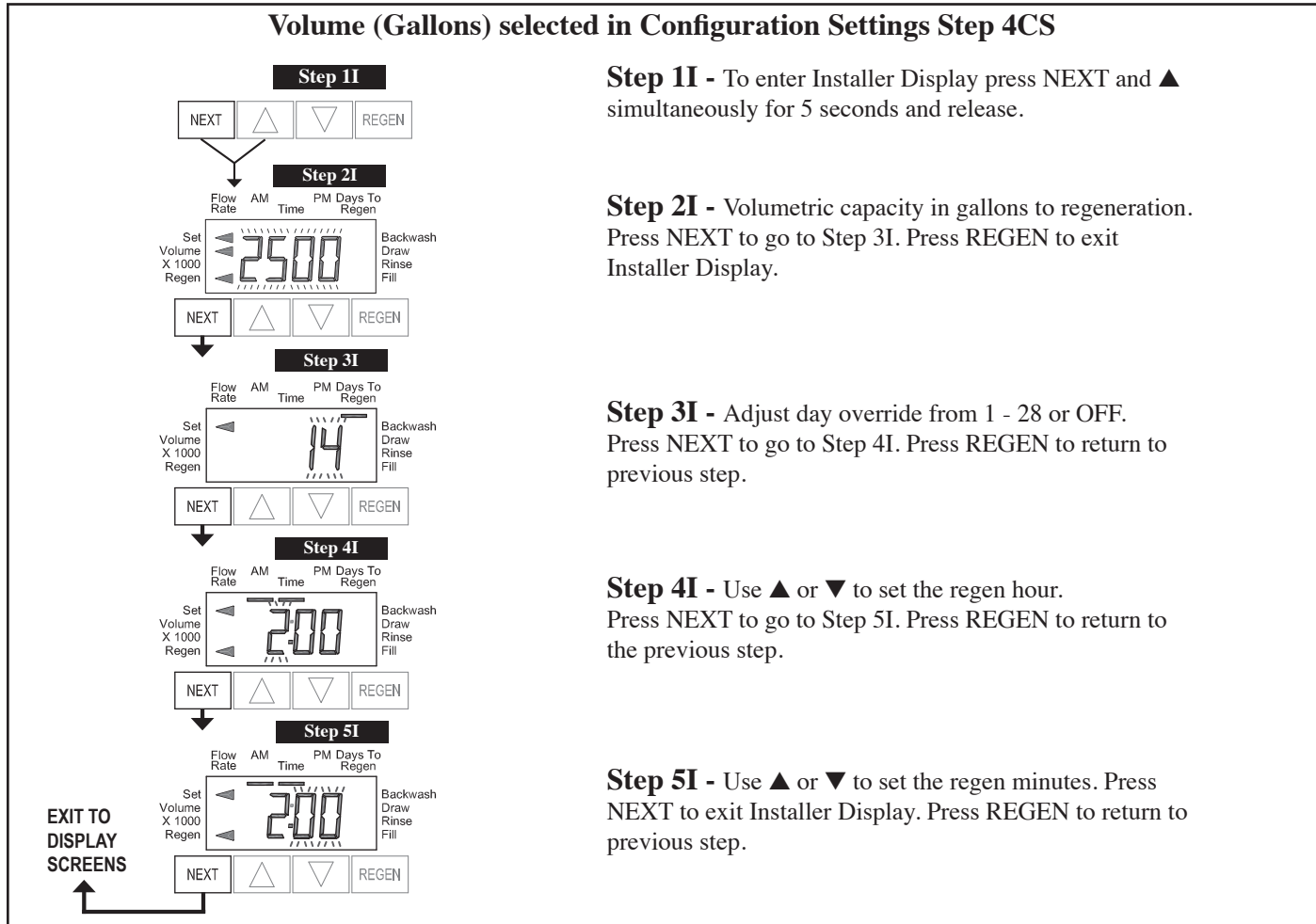

28 Day or 28/Volume (Gallons) selected in Configuration Settings Step 4CS

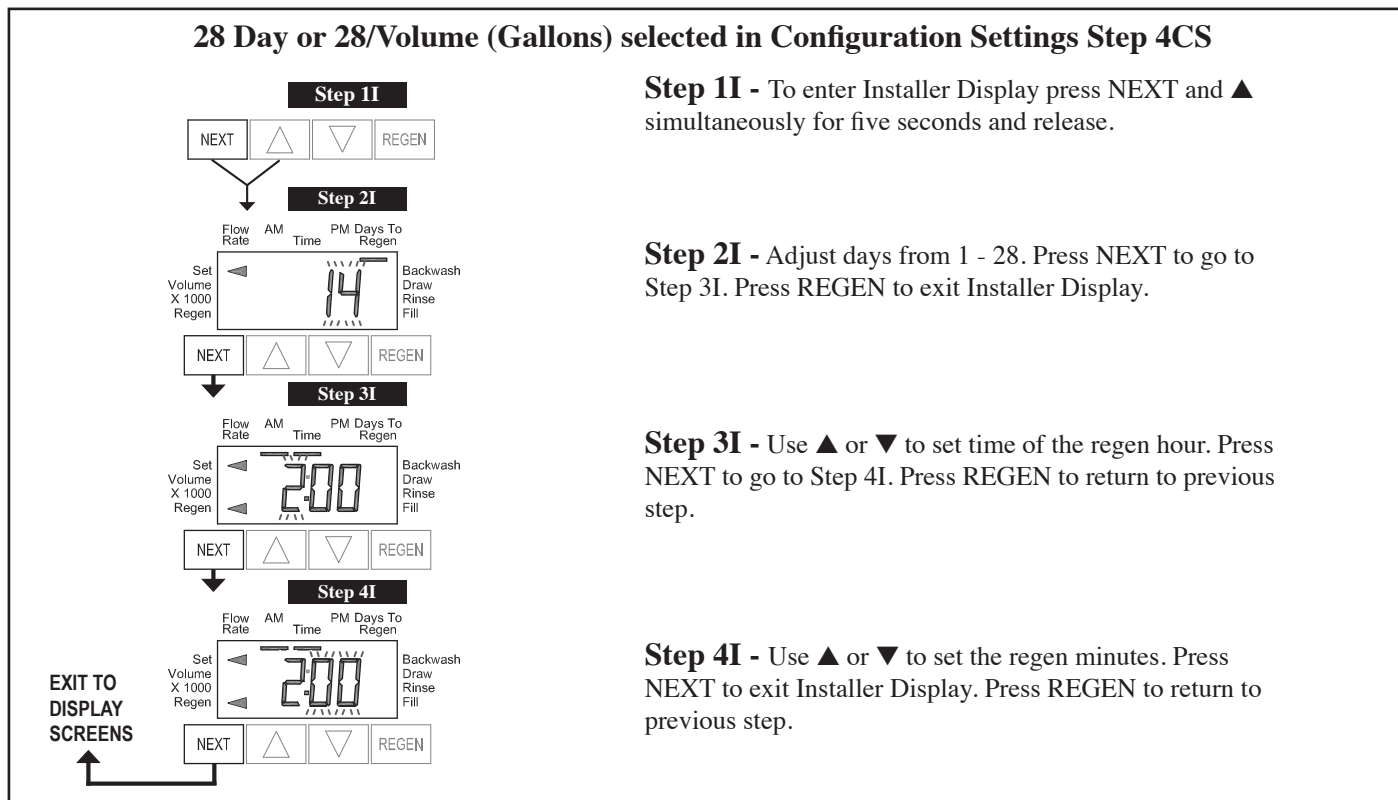

7 Day or 7/Volume (Gallons) selected in Configuration Settings Step 4CS

Step 1I



Step 2I



Step 3I

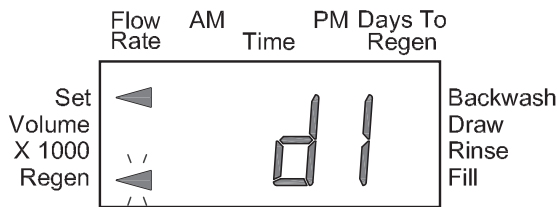

Step 4I

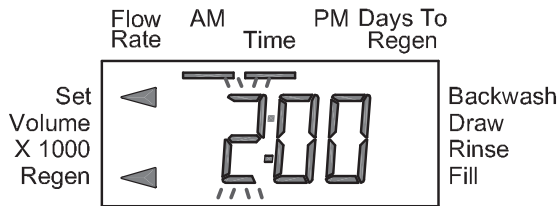

Step 5I

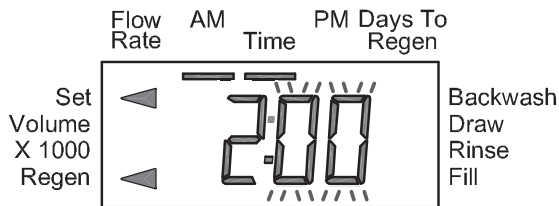

**EXIT TO
DISPLAY
SCREENS**

Step 1I - To enter Installer Display press NEXT and ▲ simultaneously for 5 seconds and release.

Step 2I - Use ▲ or ▼ to set the current day of the week. Default = 2 (Monday)

- 1 = SUNDAY
- 2 = MONDAY
- 3 = TUESDAY
- 4 = WEDNESDAY
- 5 = THURSDAY
- 6 = FRIDAY
- 7 = SATURDAY

Press NEXT to go to Step 3I. Press REGEN to exit Installer Display.

Step 3I - Scroll through days 1 to 7 using NEXT. Use ▲ or ▼ to turn regen on or off for each individual day (regen indicator on means regeneration will happen). After completing the 7th day, press NEXT to go to Step 4I. Press REGEN to go to previous display.

Step 4I - Use ▲ or ▼ to set the regen hour. Press NEXT to go to Step 5I. Press REGEN to go to previous display.

Step 5I - Use ▲ or ▼ to set the regen minutes. Press NEXT to exit Installer Display. Press REGEN to return to previous display.

Diagnostics

Step 1D

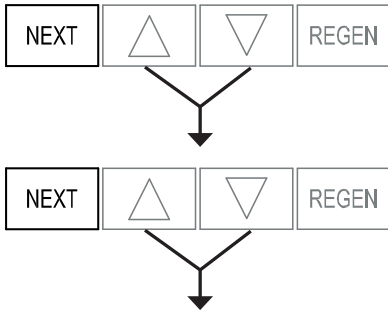

Step 2D

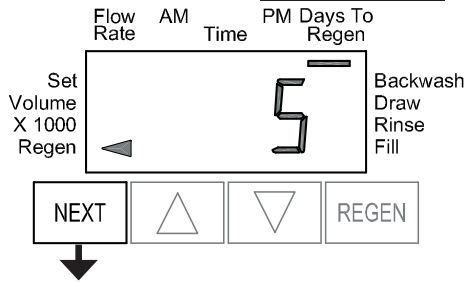

Step 3D

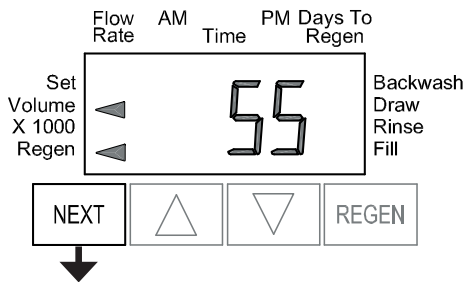

Step 4D

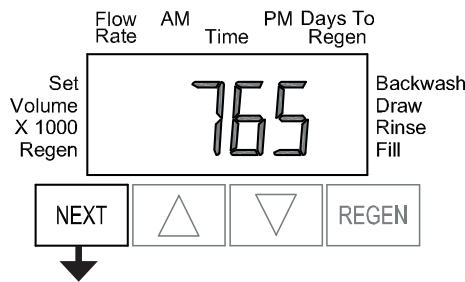

Step 5D

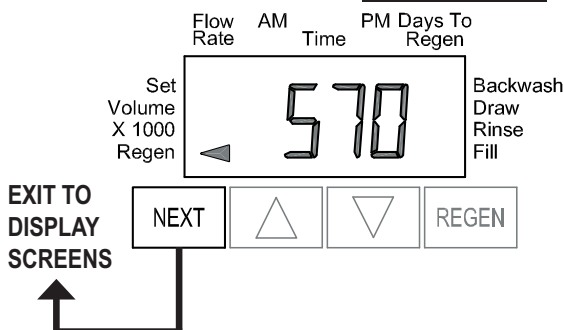

Step 1D - Press ▲ and ▼ simultaneously for 5 seconds and release. Then press ▲ and ▼ simultaneously for 2 seconds and release. If screen in Step 2D does not appear the lock on the valve is activated. To unlock press ▼, NEXT, REGEN, ▲ in sequence, then press ▲ and ▼ simultaneously for 5 seconds and release. Then press ▲ and ▼ simultaneously for 2 seconds and release.

Step 2D - Display shows the number of days since a regeneration last occurred. Press NEXT to go to Step 3D. Press REGEN to exit Diagnostics.

Step 3D - Display shows the volume of water treated in gallons treated since the last regeneration. If Volume (gallons), 28/Volume (gallons), or 7/Volume (gallons) was selected in Step 4CS and no meter is installed this display will read 0. Press NEXT to go to Step 4D. Press REGEN to return to previous step.

Step 4D - Display shows the days in service since start up. Press NEXT to go to Step 5D. Press REGEN to return to previous step.

Step 5D - Display shows the total number of regeneration cycles since start up. Press NEXT to exit Diagnostics. Press REGEN to return to previous step.

Revision History:

12/7/2012

PAGE 5:

Added - “Used with valve type 1.0T,...”