

# BIG BUCK HUNTER<sup>®</sup> *Pro* OPEN SEASON<sup>™</sup>



Play Mechanix<sup>™</sup>



## CONVERSION KIT

Setup and Service Manual

## Table of Contents

Installation Overview .....	3
Safety .....	5
Preparation .....	6
Installation .....	9
Adjustments, Audits and Diagnostics .....	21
Troubleshooting .....	43
BIOS Settings .....	46
Wiring and Parts .....	47
Drilling and Mounting Templates .....	51

# Big Buck Hunter® Pro Open Season™ Conversion Kit

## Installation Overview



1. Drill start button holes from template through overlay, artwork and wood. Insert buttons into control panel.



2. Drill gun cable and (if needed) cover plate holes from template. Mount gun and cover plates to front panel.



3. Trim marquee art and insert behind protective panel. Refasten hardware.



4. Mount side panel decals.



5. Drill gun hook holes from template and affix two hooks per side.

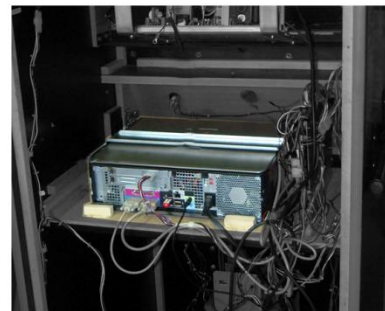

6. Restrain PC to shelf with bracket and wood screws. Glue cleats in front and rear.

### Installation Overview Continued

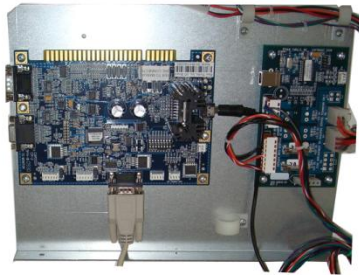

7. Identify location for electronics tray.

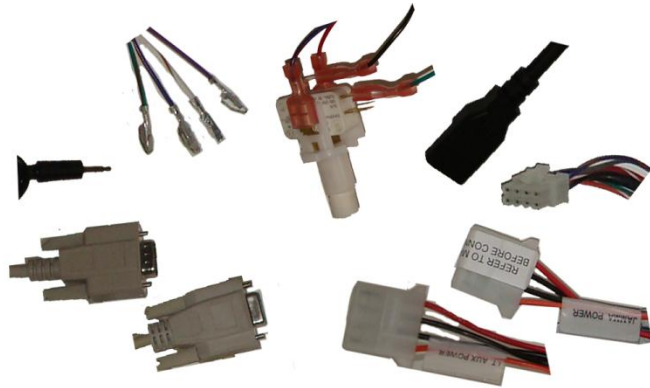

8. Attach only required cables.



9. Attach JAMMA harness to I/O board.



10. Fasten tray to cabinet.

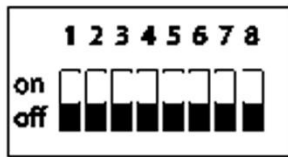

11. Confirm DIP switch settings.

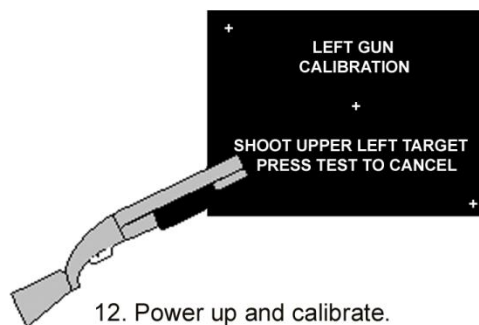

12. Power up and calibrate.

# Big Buck Hunter<sup>®</sup> Pro *Open Season*<sup>™</sup> Conversion Kit

## Safety

### Who Should Use this Manual

This manual and the conversion process are intended for skilled technicians, qualified to work with AC voltage and knowledgeable about safety procedures common with electrical devices, delicate components, power tools and heavy equipment. The photographs used in this manual illustrate a conversion from a game that may be different than yours. Use your judgment to determine how best to modify your conversion for your own situation. Please take the time to read through this manual carefully, paying close attention to the safety warnings. Failure to follow instructions may result in property damage, injury or death.

### Important Safety Warnings

#### TRANSPORTING

Use appropriate care when moving or transporting your game.

#### DISCONNECT POWER

Always turn the power off and unplug the unit before servicing or making adjustments unless otherwise instructed. Installing or repairing components while power is on can damage the components and void the warranty.

#### GROUNDING

Avoid electrical shock. Do not plug in AC power until you have inspected and properly grounded the unit. Only plug into a grounded, three-wire outlet. Do not use a “cheater” plug or cut off the ground pin on the line cord.

#### POWER SELECTOR SWITCH

Set the 115/230 VAC selector switch on the PC for the correct line voltage on the installation site.

#### CONNECTORS

Ensure all connectors mate properly. If connectors do not slip in easily, do not force them. Connectors are often keyed and only connect one way. Check for correct orientation.

#### CONNECTOR LABELS

Do not remove labels on kit components unless specifically instructed. In the event the kit is transferred to another cabinet, important warnings on connectors must remain in place to prevent injury or damage to game.

#### COMPUTER

The computer contains sensitive components, including a hard drive. Do not handle roughly. Call your distributor before servicing its internal components. Ask about warranty information as it relates to the PC.

After the first time you turn the computer power switch to ON, leave it permanently on. Always turn off AC power from the cabinet switch.

## Preparation

### Verify Cabinet Suitability

The best candidate cabinets have the following features:

- Monitor screen is perpendicular to the ground (to ensure proper gun function).
- Monitor is 27" (CGA or VGA are acceptable).
- Cabinet is structurally sound.
- Clear protective panel protects marquee art.
- Game is completely functional—especially the monitor, speakers, coin and bill mechanisms.

*Components that do not work before the conversion will likely not work after the conversion.*

- JAMMA voltages are normal:  
5V reads between 4.9-5.1 and  
12V reads between 11.8-12.2.

*A possible cabinet for conversion*



### Prepare Cabinet

1. Unplug AC power from wall or floor.
2. Remove old PC, circuit boards, hard drives, old guns, joysticks, buttons and other components **except** those on the list below, which are required in the converted game.

*If any items below are missing, install them before proceeding.*

- Power to the marquee lights,
  - Power to the coin and bill acceptors,
  - Power to the monitor,
  - Power to the speakers,
  - A functional JAMMA harness
3. If you intend to use an existing card reader in the future, you may keep it in place.
  4. Remove loose debris, old manuals, keys, spare parts, etc. and exposed wiring from the cabinet.

### Obtain Materials and Tools

For this conversion, you will need the following

- Clear protective panel (like Plexiglas) the size of the control panel board
- Wood glue
- Power drill
- Utility knife
- Tape measure
- 1" and 1.5" hole saws
- ¼" and 3/16" drill bits

# Big Buck Hunter<sup>®</sup> Pro *Open Season*<sup>™</sup> Conversion Kit

## Examine the Bill of Materials

Ensure all items on the Bill of Materials are present and in good condition.

*Note that the appearance of some components may differ from the photographs in this manual.*

### Manuals

- Conversion manual (which you are now reading)
- Restore DVD

### Electronics

- Electronics tray with I/O, watchdog boards and cables:
  - VGA
  - Serial DB9
  - Audio
  - Watchdog power
  - Power/Start buttons/JAMMA hookup

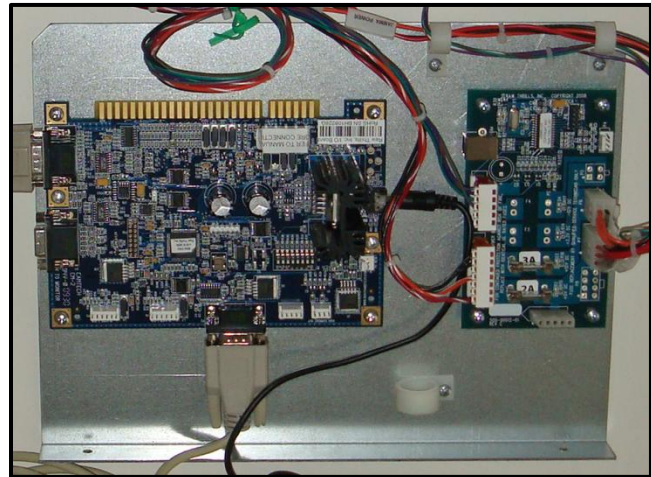

*Electronics Tray:*

*I/O board on left, watchdog board on right*

- 6 #8 x 3/4" wood screws (for restraint bracket and electronics tray)
- AC adapter cable
- Game PC
- 4 wood cleats
- PC restraint bracket



*Restraint bracket with wood screw*

- 4 restraint bracket screws
- USB game dongle (taped to the PC)



*Game dongle*

## Front and Side Panel Components

- Orange gun with cable and mounting plate
- Green gun with cable and mounting plate
- 4 gun hook brackets
- 17 10-24 x 1.25" carriage bolts (for gun cables, hooks and cover plate)
- 17 10-24 keps nuts(for gun cables, hooks and cover plate)
- Triangular cover plate

## Artwork

- Left cabinet side art decal
- Right cabinet side art decal
- Control panel overlay
- Marquee graphic

## Templates

- Control panel start button hole
- Gun rack hook mounting on outside panels
- Gun cable plate mounting to front panel



# Big Buck Hunter® Pro Open Season™ Conversion Kit

## Installation

### Modify Control Panel



*Converted control panel with buttons and artwork*

1. Remove clear protective panels, buttons, guns, gun racks, joysticks, decals and artwork, etc. to create a flat, plain wooden control panel.

*It may be necessary to fill holes in panel before drilling for start buttons.*

*Do not fill screw holes that originally held overlay. Retain those screws.*

*Clean wood with a damp cloth and let dry so the decal can stick well.*

2. Using old overlay as a template, trim new clear protective overlay to the same size.
3. Trim control panel artwork to the size of the new overlay.  
*Make sure text will be centered on the control panel board.*
4. Remove backing from decal and apply decal to control panel.
5. With a knife or awl, cut holes in the new artwork for the screws that held original overlay.
6. Hold new clear overlay in position and drill pilot holes where screws will go.
7. Mount new overlay with original screws.

## Mount Buttons

1. Using Start button template (in back of this book), mark locations for new Start buttons.  
*Leave about 10" between the centers of the two buttons and avoid blocking words.*
2. Drill large center hole for left (green) button with 1" hole saw.
3. Drill two locating holes for left button with 3/16" bit.
4. Repeat steps 2-3 for right (orange) button.
5. Remove green button from lamp/switch assembly.  
*Do not remove any wires from assembly.*

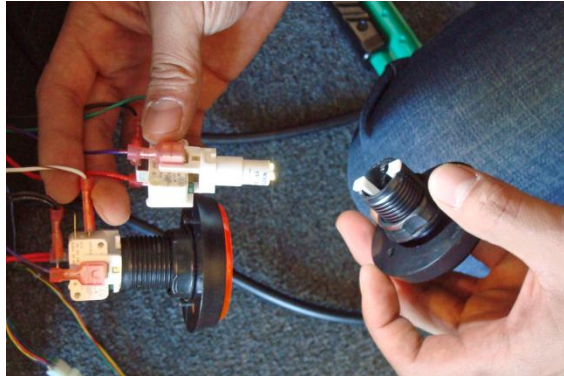

*Removing green button from lamp/switch assembly*

6. Remove plastic nut from button.
7. Place button in left button hole.  
*Align nibs on underside of button with locator holes to hold it in place.*
8. From underneath the control panel, hand tighten plastic nut while holding button down.
9. Repeat steps 5-8 with orange button.

# Big Buck Hunter® Pro Open Season™ Conversion Kit

## Gun Installation



*Gun cable mount on front panel*

1. Hold gun cable mount template (in back of this book) to front panel to identify hole locations.  
*Ensure that coin door can open without hitting the plates or cables.*  
*Locate both plates the same height above ground.*
2. Drill center hole for left cable using 1.5" hole saw.
3. Drill three bolt holes with .25" bit.
4. Insert green gun connector cable through center hole.  
*Ensure gun colors match start button colors with green on left.*
5. Align triangular plate with bolt holes.
6. Insert three 10-24 x 1.25" carriage bolts through each triangular plate.
7. Inside cabinet, fasten a 10-24 keps nut over each bolt.  
*Rest gun on floor for now.*
8. Repeat steps 2-7 for the orange gun.
9. If necessary, repeat steps 2-7 for cover plate to conceal existing hole in front panel.

## Replace Marquee

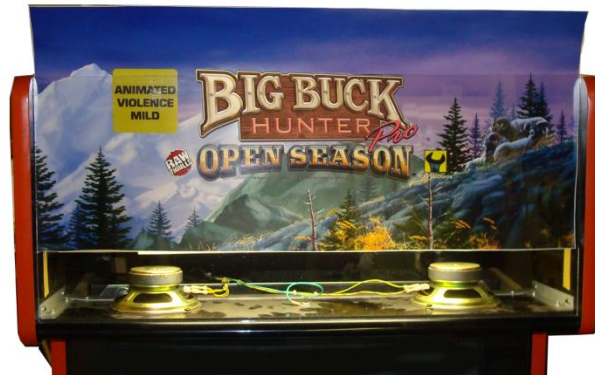

*Marquee inserted into top of cabinet*

1. Remove screws, brackets and any hardware necessary to access existing marquee graphic.
2. Remove existing clear protective panel and marquee graphic.
3. Trim Big Buck Hunter® Pro *Open Season*™ marquee graphic to fit behind protective panel.
4. Insert new marquee graphic with clear protective panel.
5. Refasten original hardware.

# Big Buck Hunter® Pro Open Season™ Conversion Kit

## Install Cabinet Side Art



*Left decal in place*

1. Clean left side panel with damp cloth and create a flat, smooth surface.
2. Remove backing from left side panel decal.
3. Apply decal to left side panel.  
*Ensure decal is parallel to cabinet edges and centered horizontally.*  
*Note position of decal so you can match the other side.*
4. Repeat steps 1-3 on right side panel.

## Install Gun Hooks



*Mounted gun hook*

1. Identify location of gun hooks on one side of cabinet.  
*Hooks should be 3 feet from the floor and allow guns to rest clear of artwork or obstructions.*
2. Hold gun hook template (in back of this book) up to side panel, centered horizontally.
3. Drill two holes using .25" drill bit. (See illustration below).
4. Holding bracket in place, insert two 10-24 x 1.25" carriage bolts through bracket into side panel.
5. Inside cabinet, fasten a 10-24 keps nut over each carriage bolt.
6. Repeat steps 2-5 for second bracket.
7. Hang the gun on the gun hooks.
8. Repeat steps 1-7 on other side.

*Important: Ensure that the Gun Hooks are same height on both sides of the cabinet and that the mounting bolts don't interfere with any internal cabinet components. Front hook placement is shown below, but the other hook should be about 6" from the rear of the cabinet.*

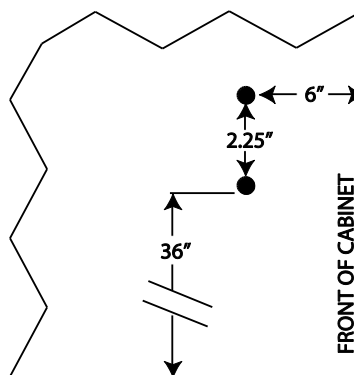

**DRAWING NOT TO SCALE**

*Gun rack bracket holes drilling location*

# Big Buck Hunter<sup>®</sup> Pro *Open Season*<sup>™</sup> Conversion Kit

## Install PC

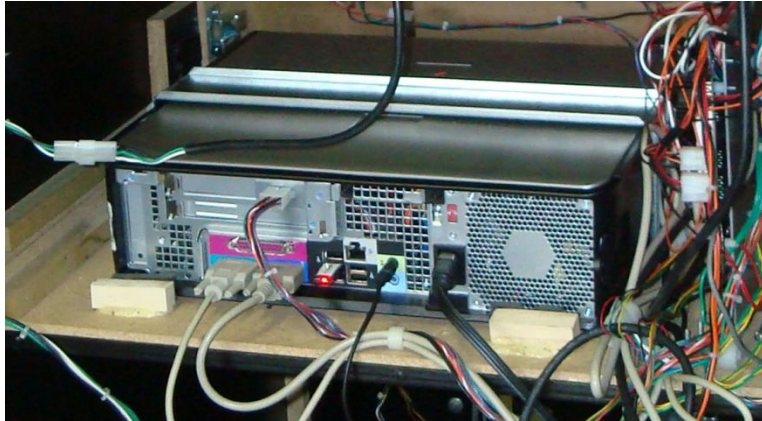

*PC on shelf with cleats glued in place and restraint bracket*

1. Identify a stable position in the cabinet to place the game PC that meets the following conditions:
  - It will rest on a solid, horizontal board at least  $\frac{3}{4}$ " thick;
  - There is enough vertical clearance to accommodate the PC plus a few inches access for a screwdriver or power drill;
  - The DVD-ROM drive tray faces the front of the cabinet and can fully extend unobstructed;
  - There is clear access to plug cables into the rear of the PC.
2. Place the PC on the horizontal board facing the front of the cabinet.
3. Position the metal restraint bracket over the PC with legs on right and left side of PC.
4. Hold the bracket steady and drill four pilot holes through the bracket feet.
5. Insert four #8 x  $\frac{3}{4}$ " wood screws into the holes on the bracket feet.  
*Do not tighten screws yet.*
6. Push down on the bracket and slide it so the screw heads will be held in place by the thin ends of the keyhole slots.
7. Tighten the screws and ensure the PC is well restrained left to right.
8. Place two cleats in front and two behind PC so they are flush against the case.
9. Using wood glue, affix cleats to board and clamp in place until glue dries.

## Locate Electronics Tray

1. Identify a suitable location for the electronics tray so holes rest on a stable horizontal board at least  $\frac{1}{4}$ " thick.  
*Cabling should hang clear of obstructions.*  
*Start button cables should reach control panel.*  
*JAMMA harness should be able to plug into I/O board easily with suitable vertical clearance.*  
*PC DVD-ROM drive should open without obstruction.*
2. Drill pilot holes into wood through holes in foot of tray.

## Connect Cables

### CONNECTOR CAUTION

Ensure all connectors mate properly. If connectors do not slip in easily, do not force them. Connectors are often keyed and only connect one way. Check for correct orientation.

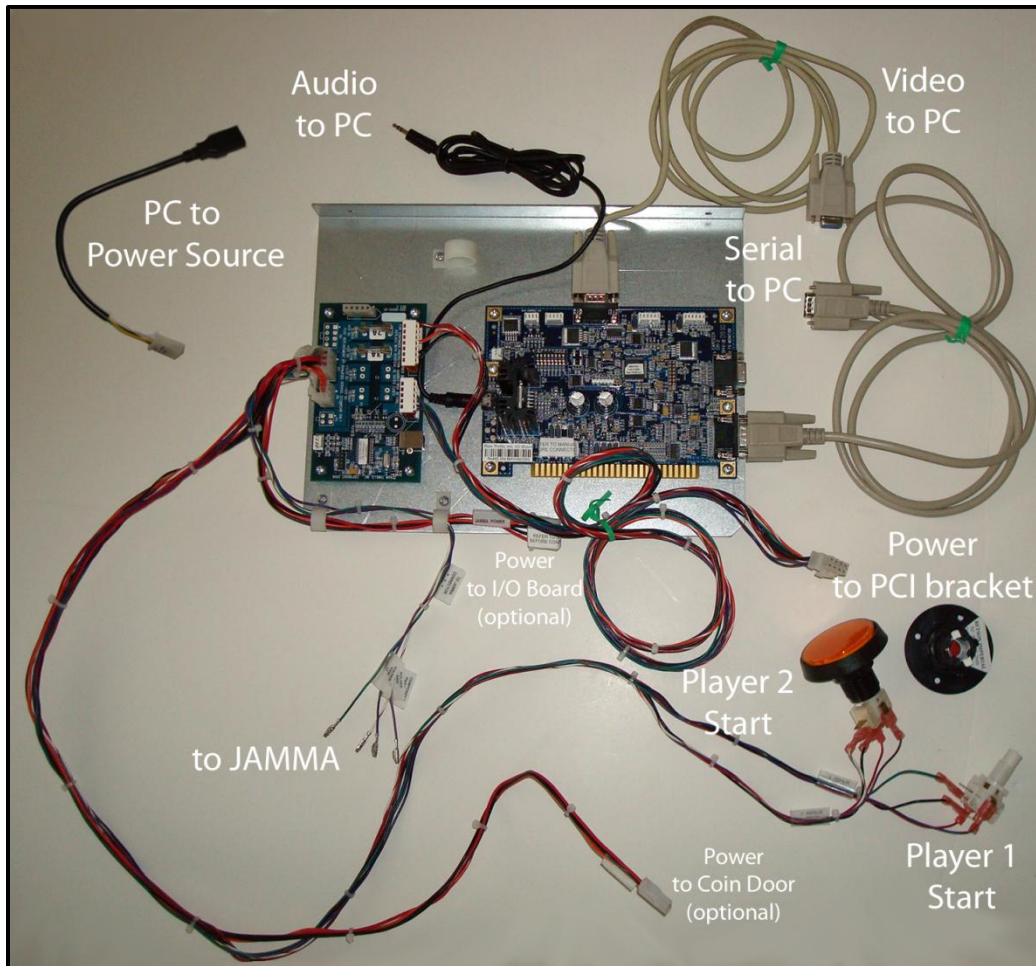

*AC adapter cable and electronics tray (and attached cables) with Player 1 Start button disconnected*

### Start Buttons

1. Attach Player 1 Start switch/lamp assembly into green button on control panel.  
*Push and twist assembly to lock.*
2. Attach Player 2 Start switch/lamp assembly into orange button on control panel.

### ELECTRICAL WIRING

Ensure all connections are properly insulated and grounded. These instructions are intended for personnel with experience working with AC power. Injury and death or equipment damage can result from poor safety habits.



# Big Buck Hunter<sup>®</sup> Pro Open Season<sup>™</sup> Conversion Kit

## JAMMA Harness

1. Ensure these four locations in JAMMA housing are empty:  
pin 17 solder and component sides, pins 8 and 9 solder side.

*If populated, remove pins with pin extractor tool.*

**Note:** Do not leave dangling or exposed wires, which could cause a short.

*Insulate wires with electrical tape.*

2. Populate JAMMA housing with four pins as labeled.
3. Determine whether JAMMA receives AC power.

### **WARNING: JAMMA I/O POWER**

If the JAMMA harness is receiving power from an existing power supply via pins 1-6, do not plug connector labeled "JAMMA Power" into the I/O board and do not remove connector label so it will remain for future reference.

4. If JAMMA housing has pins in positions 1-6, then harness already receives AC power. Skip steps 5-6 and proceed to step 7.
5. If positions 1-6 are empty, remove labels from 4-pin JAMMA power cable connector as well as corresponding PCB connector on I/O board.
6. Plug JAMMA power cable into PCB connector on I/O board.

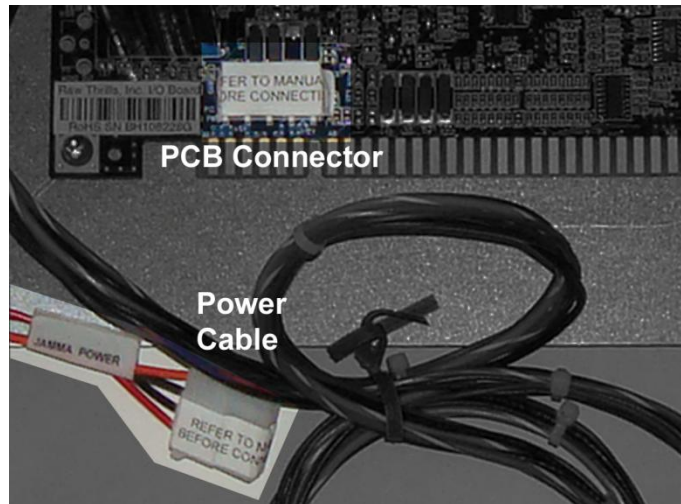

*Connect JAMMA power cable to I/O board only if pins 1-6 are empty.*

7. If there is already a power connection to the coin door, skip step 9.
8. If there is no power to coin door, connect the Aux. Power cable to existing mating connector.
9. Connect JAMMA housing onto I/O board.

## PC Ports

The only deviation from standard PC ports (AC power, USB, video and serial) is the addition of an eight-pin power connector expansion card.

1. Attach electronics tray connectors to the following PC ports:
  - I/O to Serial
  - I/O to Video
  - I/O to Audio
  - Watchdog to 8-pin PCI bracket
2. Insert the game dongle into one of the USB ports.
3. Connect IEC plug of AC adapter cable into PC.
4. Safely and appropriately connect remaining end of AC adapter cable to power source.

## ELECTRICAL WIRING

Ensure all connections are properly insulated and grounded. These instructions are intended for personnel with experience working with AC power. Injury and death or equipment damage can result from poor safety habits.

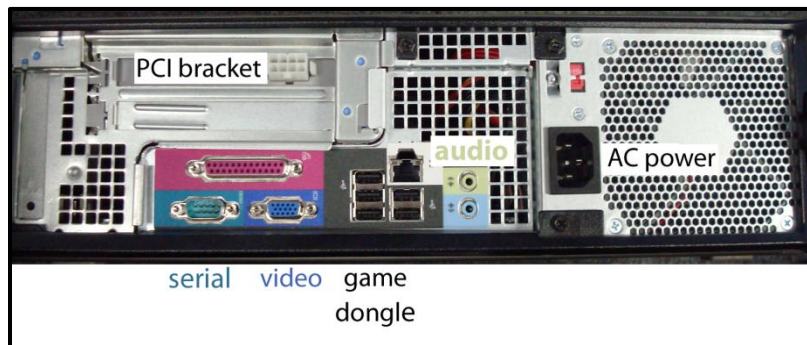

*Ports in rear of PC*

## Guns

1. Connect the left (green) gun cable to the Player 1 connector on the I/O board.
2. Connect the right (orange) gun cable to the Player 2 connector on the I/O board.
3. Place each gun in its corresponding pair of hooks.

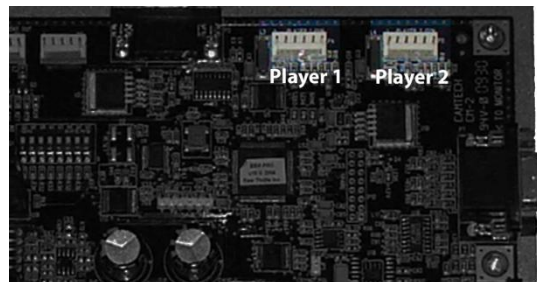

*At top right of I/O board, gun connectors*

# Big Buck Hunter<sup>®</sup> Pro *Open Season*<sup>™</sup> Conversion Kit

## Fasten Electronics Tray

1. Affix tray to the board with two #8 x 3/4" wood screws through pre-drilled pilot holes.

## Confirm Monitor DIP Switches

If using a VGA monitor, set all DIP switches to OFF. Otherwise, please see chart below.

### *JAMMA I/O DIP SWITCH SETTING:*

8	Watchdog Defeat (Important: Always set to OFF for normal operation)
7	OFF
6	OFF
5	VSYNC POLARITY
4	HSYNC POLARITY
3	DIPSW3 (Display resolution; see below)
2	DIPSW2 (Display resolution; see below)
1	DIPSW1 (Display resolution; see below)

### *Display Resolution DIP Switch Settings*

DIPSW1	DIPSW2	DIPSW3	Display Resolution
off	Off	Off	VGA (640x480)
on	Off	Off	MEDRes (EGA 400x256)*
off	On	Off	MEDRes (EGA 400x256)*
on	on	On	STDRes (CGA 320x240)

\* Some MEDRes (EGA) monitors handle white flash timing differently. To test for this, enter the Gun Calibration function. If trigger is pulled but white flash doesn't cover the entire screen, try the other MEDRes (EGA) dipswitch setting. Reboot your machine after making changes so that new dipswitch settings will take effect

## Finish Installation

1. Connect I.E.C. AC plug into back of cabinet.
2. Turn cabinet power switch on.

## First Calibration

Upon first startup and reboots, the game enters calibration mode. Note that weekly gun recalibration helps maintain gun performance, improve player enjoyment and enhance revenue.



1. Remove left gun from the hooks and hold the muzzle about three feet from the monitor. Follow the on screen instructions to shoot the target.
2. Once satisfied with the calibration, press the START button corresponding with the gun color.
3. Replace the gun into its hooks.
4. Repeat steps 1-3 with the right gun.

# Big Buck Hunter<sup>®</sup> Pro Open Season<sup>™</sup> Conversion Kit

## Adjustments, Audits and Diagnostics

### Basic Display Adjustments

#### HIGH VOLTAGE

Monitor assemblies carry dangerously high voltage. Neither PlayMechanix<sup>™</sup> Inc. nor Raw Thrills<sup>™</sup> Inc. recommend you perform any service on the monitor, as it contains no user serviceable parts.

The I/O board relies on signals detected from the display to operate. Display quality is critical to ensure the guns operate correctly and reliably. Weekly gun calibration is also important.

Display settings differ between manufacturers or models from the same manufacturer. Factors like display age may affect quality. This is a reference. Actual settings may not be practical in some cases.

Setting	Adjustment
Brightness	<b>Function:</b> Background brightness or black level <b>Set Level:</b> Black background should appear dark, not gray.
Contrast	<b>Function:</b> Definition/sharpness of character against background <b>Set Level:</b> Outer edges of character or text should not be distorted.
H-Position	<b>Function:</b> Horizontal Position. Side-to-side centering <b>Set Level:</b> Picture should be centered from side to side.
H-Size	<b>Function:</b> Horizontal Size. Side-to-side dimension <b>Set Level:</b> Picture should be full from side to side.
V-Position	<b>Function:</b> Vertical Position. Up/down centering <b>Set Level:</b> Picture should be centered up and down.
V-Size	<b>Function:</b> Vertical Size. Up/down dimension <b>Set Level:</b> Picture should be full from top to bottom.
Pin Cushion	<b>Function:</b> Degree of straightness along both vertical sides of the picture. <b>Set Level:</b> Both sides of the picture should be straight without curvature.
Degauss	<b>Function:</b> De-magnetizes the picture tube when activated. This eliminates picture discoloration caused by magnetic disturbance around the picture tube.

Digital displays are adjusted with a button-type remote board. Below are functional diagrams for common 27" digital displays.

#### Kortec Remote

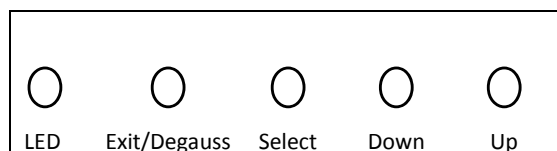

**Exit/Degauss:** Exit menu or degauss  
**Select:** Selects setting to be adjusted  
**Down:** Cycles downward through levels  
**Up:** Cycles upward through levels

#### Wells Gardner

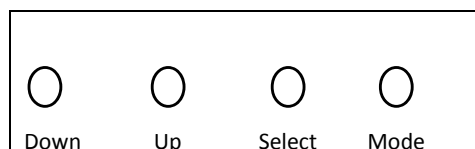

**Down:** Cycles downward through levels  
**Up:** Cycles upward through levels  
**Select:** Selects setting to be adjusted  
**Mode:** Menu/Exit

### Diagnostic Menu System

The Service Button Panel should have four buttons, three of which can navigate the menu system. But it is easiest to navigate with a Start button and trigger/ pump.

Service Panel TEST button	enters diagnostic system
Either Start button or TEST button	selects the highlighted option
Service Panel VOL - button or Squeezing either trigger	moves down through menu or setting choices
Service Panel VOL + button or Pumping either gun	moves up through menu or setting choices

Highlight and select Exit to return to previous screen.

An on-screen message acknowledges changes or when you exit a selection without making a change.

At the bottom of each screen is a brief description of the menu choice function. A complete description of all menu functions is available here.

## Menu Screens and Descriptions

### Main Menu

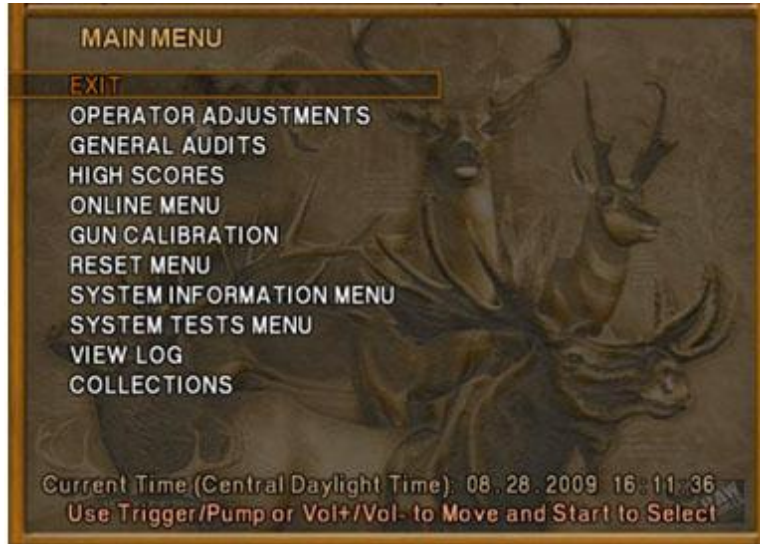

For clarity, all subsequent menu screens in this manual will not include the header, footer or background image.

### Main Menu

#### Operator Adjustments Menu

This menu controls gameplay, coinage and sound adjustments.

**OPERATOR ADJUSTMENTS**  
**EXIT**  
**GAME ADJUSTMENTS**  
**COIN ADJUSTMENTS**  
**PLAYER COST**  
**VOLUME**

You can improve collections by customize performance with game adjustments. Each variable on an adjustment menu changes an aspect of game play or appearance. Optimizing these settings can maintain player interest and improve earnings. Monitor the effects of adjustments by comparing audit information and earnings before and after changes.

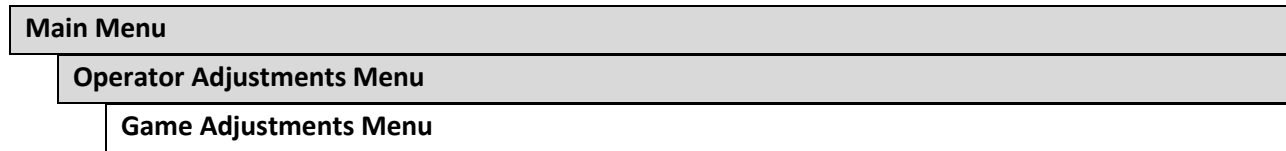

This controls elements of the player experience and the time the game contacts the CoinUp® server to check for software updates.



**Settings, Defaults and Choices**

Setting	Description	Default	Choices
Violence	Changes visual effect of shot animals. <ul style="list-style-type: none"> <li>NORMAL. Some blood appears on shot animals. Red star appears on kills.</li> <li>NO BLOOD. No blood appears on shot animal. In No Blood Mode, small blue star replaces red star on kills.</li> </ul>	Normal	No Blood / Normal
Big Buck Girls	This setting allows operator to permit or eliminate images of Big Buck Girls. <ul style="list-style-type: none"> <li>ON: Big Buck Girls appear in Attract and Gameplay modes</li> <li>OFF: No Big Buck Girls appear.</li> </ul>	On	On / Off
Skill Level	Adjusts game difficulty by changing how shotgun reloads after each trigger pull. <ul style="list-style-type: none"> <li>EASY. After each trigger pull, shotgun reloads itself without pumping. To fire another shot, pull trigger again.</li> <li>NORMAL. After each trigger pull, reload by pumping.</li> </ul>	Normal	Normal / Easy
Initials Type	Adjusts how players can enter their names. <ul style="list-style-type: none"> <li>FULL NAME. Players use two screens. The first name screen allows up to 13 characters. The last name screen allows up to 15 characters.</li> <li>INITIALS. Players can enter up to three characters.</li> </ul> <b>Warning: changing to Initials Only clears high score tables.</b>	Initials Only	Full Name / Initials Only
Game Update Hour	The 60-minute period during which tournament-enabled games contact the server to check for software updates.	4-5 AM	24 hours



# Big Buck Hunter® Pro Open Season™ Conversion Kit

Main Menu

Operator Adjustments Menu

Coin Settings Menu

This menu does **not** set game price, but specifies how much game credit is given for money added to the machine. The smallest accepted coin is a quarter, the typical setting for both coin values in the U.S. The DBV value is also a multiple of 25¢.

```

COIN SETTINGS
EXIT
FREEPLAY OFF
CURRENCY TYPE Dollar
COIN 1 VALUE $0.25
COIN 2 VALUE $0.25
COIN 3 VALUE/DBV PULSE $0.25
MAXIMUM CREDITS $500.00
BONUS AWARD $0.00
UNITS FOR BONUS $0.00
    
```

## Settings, Defaults and Choices

Setting	Description	Default	Choices
Freeplay	Players can start games without money by pressing START. Use this for promotions, non-commercial applications or to test the machine.	Off	On / Off
Currency Type	Changing currency type resets coin door values. The denomination symbol changes on screen with each currency.	Dollar	Yen, Won, Ruble, Real, Peso, Krona, Guilder, Franc, Can. Dollar, Coins, Euro, NZ Dollar, Rand, Pound, Aus. Dollar
Coin 1 Value	Lets you set coin slot pricing.	\$0.25	\$0.25 - \$63.75 in \$.25 increments
Coin 2 Value	Lets you set coin slot pricing.	\$0.25	\$0.25 - \$63.75 in \$.25 increments
Coin 3 Value / DBV Pulse	The bill validator (DBV) translates bills into electronic pulses. Every \$1 bill results in four pulses; each \$5 bill is 20 pulses; \$10 bill is 40 pulses, etc. This setting determines how much game credit is awarded per pulse. With default setting of \$0.25, every \$1 bill will award \$1 in game credit. Set to \$0.50, every \$1 bill will award \$2 in game credit.	\$0.25	\$0.25 - \$63.75 in \$.25 increments
Maximum Credits	The highest number of unplayed credits allowed.	\$500.00	\$125 - \$500 in \$.25 increments
Bonus Award	The amount of credit awarded per bonus unit (see below).	\$0.00	\$0.00 - \$63.75 in \$.25 increments
Units for Bonus	The value a player must enter to get bonus credit.	\$0.00	\$0.00 - \$50.00 in \$.25 increments

Bonus Award/Units for Bonus Example.

To give players \$1.25 in credit for every dollar put in the DBV, set Bonus award to \$.25 and Units for Bonus to \$1.

<b>Main Menu</b>
<b>Operator Adjustments Menu</b>
<b>Player Cost Menu</b>

<b>PLAYER COST</b>			
<b>TYPE</b>	<b>-OPER FEE-</b>	<b>COINUP FEE</b>	<b>- - TOTAL</b>
<b>EXIT</b>			
<b>TREK</b>	<b>\$1.00</b>	<b>\$0.00</b>	<b>\$1.00</b>
<b>ADVENTURE</b>	<b>\$2.50</b>	<b>\$0.00</b>	<b>\$2.50</b>
<b>BONUS ONLY</b>	<b>\$1.00</b>	<b>\$0.00</b>	<b>\$1.00</b>
<b>TROPHY CLUB TREK</b>	<b>\$1.00</b>	<b>\$0.50</b>	<b>\$1.50</b>
<b>TROPHY CLUB ADV.</b>	<b>\$2.50</b>	<b>\$0.50</b>	<b>\$3.00</b>
<b>TROPHY BONUS ONLY</b>	<b>\$1.00</b>	<b>\$0.50</b>	<b>\$1.50</b>
<b>PLAYER CARD</b>	<b>\$0.25</b>	<b>\$2.75</b>	<b>\$3.00</b>

Settings, Defaults and Choices

Setting	Description	Operator Fee Default	Choices
Trek	A <i>trek</i> lets players hunt at five sites and one bonus game.	\$1.00	\$0.00 - \$63.75 in \$0.25 increments
Adventure	An <i>adventure</i> is three treks (15 sites and three bonus games).	\$2.50	\$0.00 - \$63.75 in \$0.25 increments
Bonus Only	A <i>bonus only</i> is four bonus games.	\$1.00	\$0.00 - \$63.75 in \$0.25 increments
Trophy Club Trek	This is the online version of a trek (tracks player stats).	\$1.00	\$0.00 - \$63.75 in \$0.25 increments Only Operator Fee can be modified.
Trophy Club Adv.	This is the online version of an adventure (tracks player stats).	\$2.50	\$0.00 - \$63.75 in \$0.25 increments Only Operator Fee can be modified.
Trophy Bonus Only	This is the online version of bonus only.	\$1.00	\$0.00 - \$63.75 in \$0.25 increments Only Operator Fee can be modified.
Player Card	The card holds player login information.	\$0.25	Cannot be modified

**FEE ADJUSTMENT**

Note that CoinUp® fee cannot be adjusted by the operator.

# Big Buck Hunter® Pro Open Season™ Conversion Kit

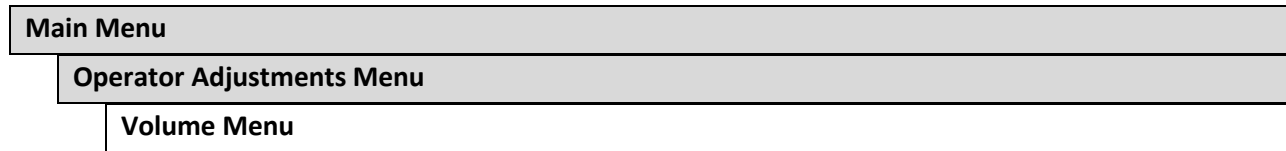

Rather than requiring a manual dial or up/down buttons, all volume adjustments can be made digitally with this menu. However, during Attract Mode, pressing the Service Panel Vol + and Vol – buttons only adjust Attract Mode volume.

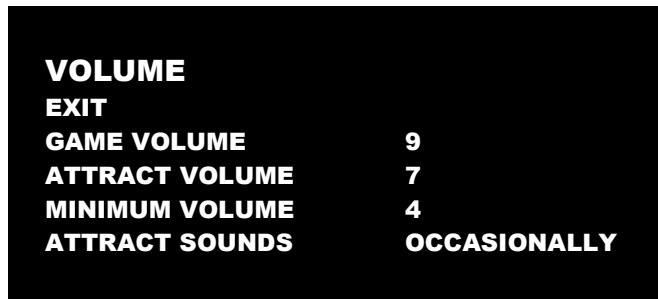

## Settings, Defaults and Choices

Setting	Description	Default	Choices
Game Volume	This affects sound only while game is played.	9	0 – 32
Attract Volume	This can be silenced or turned up as an advertisement to draw in players.	7	0 – 32
Minimum Volume	Determines the lowest setting possible for both Game and Attract Volumes	4	0 – 32
Attract Sounds	This determines how often the game’s “advertising” sounds will be heard.	Occasionally	Off/Occasionally/Always

<b>Main Menu</b>
<b>General Audits Menu</b>

Audit screens help assess game performance, find intermittent problems, decide whether to adjust game difficulty and free game award and help maximize game earnings.

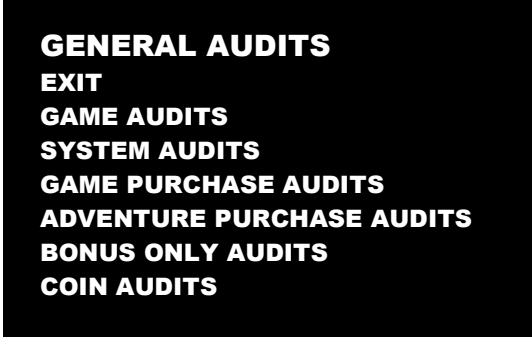

<b>Main Menu</b>
<b>General Audits Menu</b>
<b>Game Audits</b>



# Big Buck Hunter<sup>®</sup> Pro Open Season<sup>™</sup> Conversion Kit

Main Menu

General Audits Menu

System Audits

## SYSTEM AUDITS

EXIT

PLAY TIME 0 yr 0 dy—0:00:00

UP TIME 0 yr 0 dy—0:00:00

WATCHDOGS 0

EXCEPTIONS 0

BAD TRAPS 0

Main Menu

General Audits Menu

Game Purchase Audits Menu

## GAME PURCHASE AUDITS

EXIT

LOCAL PLAY PURCHASES

ONLINE PLAY PURCHASES

Main Menu

General Audits Menu

Game Purchase Audits Menu

Local Play Purchases

## LOCAL GAME PURCHASE AUDITS

EXIT

TREKS PURCHASED 0

ADVENTURES PURCHASED 0

BONUS ONLY PURCHASED 0

SHOOTOUT TREKS PURCHASED 0

SHOOTOUT ADV. PURCHASED 0

SHOOTOUT BONUS ONLY PURCHASED 0

Main Menu
General Audits Menu
Game Purchase Audits Menu
Online Game Purchase Audits

<b>ONLINE GAME PURCHASE AUDITS</b>	
EXIT	
TROPHY CLUB TREKS PURCHASED	0
TROPHY CLUB ADV. PURCHASED	0
TR. CLUB BONUS ONLY PURCHASED	0
TR. CLUB S.O. TREKS PURCHASED	0
TR. CLUB S.O. ADV. PURCHASED	0
TR. CLUB S.O. BONUS ONLY PURCH.	0
TOURNAMENTS PURCHASED	0
NATIONAL TOURNAMENTS PURCHASED	0
PLAYER CARDS PURCHASED	0

Main Menu
General Audits Menu
Adventure Purchase Audits Menu

<b>ADVENTURE PURCHASE AUDITS</b>
<b>ADV PURCHASE AUDITS: TURN-BASED</b>
<b>ADV PURCHASE AUDITS: SHOOTOUT</b>

Main Menu
General Audits Menu
Adventure Purchase Audits Menu
Turn-Based Adventure Purchase Audits

<b>ADVENTURE PURCHASE AUDITS: TURN-BASED</b>				
<b>ADVENTURE</b>	<b>WHOLE</b>	<b>TREK 1</b>	<b>TREK 2</b>	<b>TREK 3</b>
EXIT				
WHITETAIL	0	0	0	0
ELK	0	0	0	0
ANTELOPE	0	0	0	0
BIGHORN	0	0	0	0
MOOSE	0	0	0	0
CARIBOU	0	0	0	0
MULE DEER	0	0	0	0
BISON	0	0	0	0
MTN GOAT	0	0	0	0

# Big Buck Hunter® Pro Open Season™ Conversion Kit

Main Menu
General Audits Menu
Adventure Purchase Audits Menu
Shootout Adventure Purchase Audits

ADVENTURE PURCHASE AUDITS				
ADVENTURE	WHOLE	TREK 1	TREK 2	TREK 3
EXIT				
WHITETAIL SHOOTOUT	0	0	0	0
ELK SHOOTOUT	0	0	0	0
ANTELOPE SHOOTOUT	0	0	0	0
BIGHORN SHOOTOUT	0	0	0	0
MOOSE SHOOTOUT	0	0	0	0
CARIBOU SHOOTOUT	0	0	0	0
MULE DEER SHOOTOUT	0	0	0	0
BISON SHOOTOUT	0	0	0	0
MTN GOAT SHOOTOUT	0	0	0	0

Main Menu
General Audits Menu
Bonus Only Audits Menu

BONUS ONLY AUDITS			
BONUS NAME	PLAYED	BONUS NAME	PLAYED
EXIT			
DUCK HUNT	0	DOVE HUNT	0
MOONSHINE BONUS	0	BOARS GONE WILD	0
PIE IN THE SKY	0	MUG SHOT BONUS	0
PHEASANT HUNT	0	TURKEY HUNT	0
LOGYARD BONUS	0	CLOCKWORK BONUS	0
MARS NEEDS CATTLE	0	FROG FLIPPIN' BONUS	0
QUAIL HUNT	0	GOOSE HUNT BONUS	0
WINDMILL MANIA	0	BARREL BONUS	0
GOPHER GARDEN	0	METEORITE BONUS	0

Squeezing the trigger reveals the second page.

BONUS ONLY AUDITS			
BONUS NAME	PLAYED	BONUS NAME	PLAYED
EXIT			
LUMBERJACK BONUS	0		
LEMMING BONUS	0		
CORN POPPER BONUS	0		
PUMPKIN BONUS	0		
OFF THE RAILS BONUS	0		
BARNSTORM BONUS	0		
FISH IN BARREL BONUS	0		
MOUNT BUCKMORE	0		
CHICKEN & EGG BONUS	0		

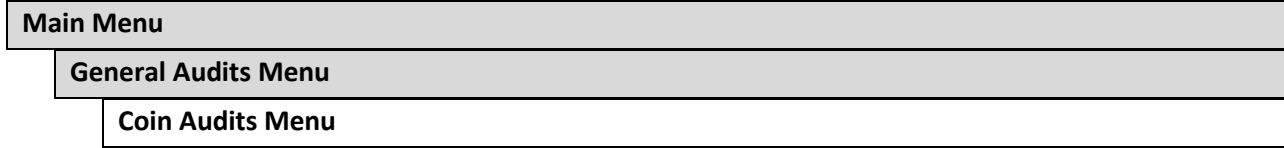

<b>COIN AUDITS</b>	
<b>EXIT</b>	
<b>TOTAL COIN 1</b>	<b>\$0.00</b>
<b>TOTAL COIN 2</b>	<b>\$0.00</b>
<b>TOTAL COIN 3 DBV</b>	<b>\$0.00</b>
<b>BONUS COINS</b>	<b>\$0.00</b>
<b>LIFETIME COIN COUNT</b>	<b>\$0.00</b>
<b>SERVICE CREDITS</b>	<b>\$0.00</b>

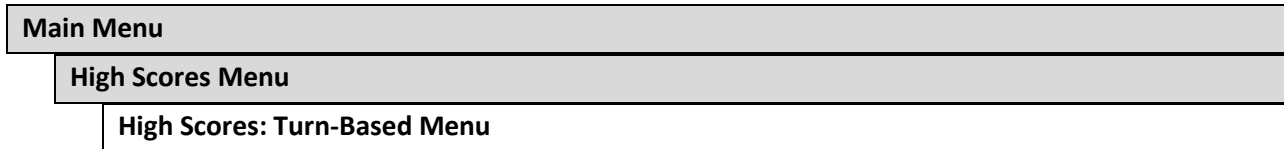

<b>HIGH SCORES: TURN-BASED</b>	
<b>EXIT</b>	
<b>WHITETAIL ADVENTURE</b>	
<b>ELK ADVENTURE</b>	
<b>ANTELOPE ADVENTURE</b>	
<b>BIG HORN SHEEP ADVENTURE</b>	
<b>MOOSE ADVENTURE</b>	
<b>CARIBOU ADVENTURE</b>	
<b>MULE DEER ADVENTURE</b>	
<b>BISON ADVENTURE</b>	
<b>MTN GOAT ADVENTURE</b>	
<b>PERFECT STREAK</b>	
<b>PERFECT SITES</b>	

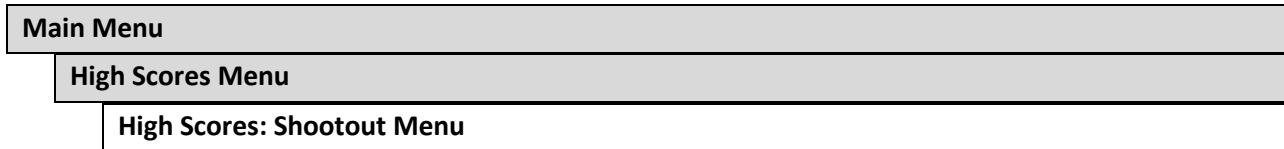

<b>HIGH SCORES: SHOOTOUT</b>	
<b>EXIT</b>	
<b>WHITETAIL SHOOTOUT</b>	
<b>ELK SHOOTOUT</b>	
<b>ANTELOPE SHOOTOUT</b>	
<b>BIG HORN SHEEP SHOOTOUT</b>	
<b>MOOSE SHOOTOUT</b>	
<b>CARIBOU SHOOTOUT</b>	
<b>MULE DEER SHOOTOUT</b>	
<b>BISON SHOOTOUT</b>	
<b>MTN GOAT SHOOTOUT</b>	



# Big Buck Hunter® Pro Open Season™ Conversion Kit

Main Menu

High Scores Menu

Animal Scoreboard

The high scores for a particular game are displayed in this format.

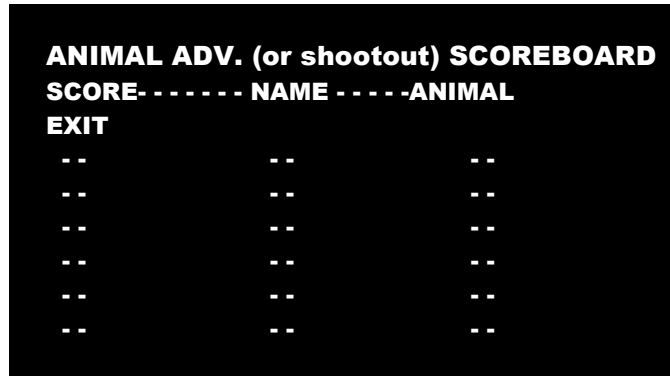

Main Menu

Online Menu

See the CoinUp® manual for a full explanation of these menu functions.

Main Menu

Gun Calibration Menu

This is the same procedure described earlier in the **First Calibration** section.

Main Menu

Reset Menu

In addition to resetting individual counters and audits, this menu erases most of your changes. *Factory Reset* clears all audit data and restores most defaults. The following data, however, is not cleared:

- Calibration
- Registration
- Game activation
- Lifetime coin count

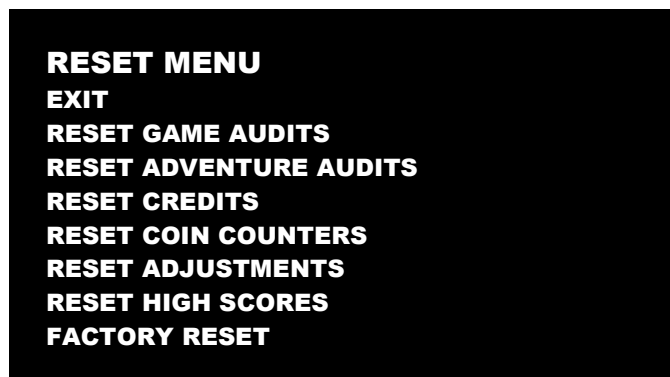

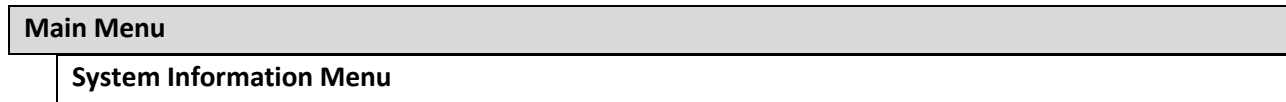

These tests verify system version and check the functioning of peripherals.

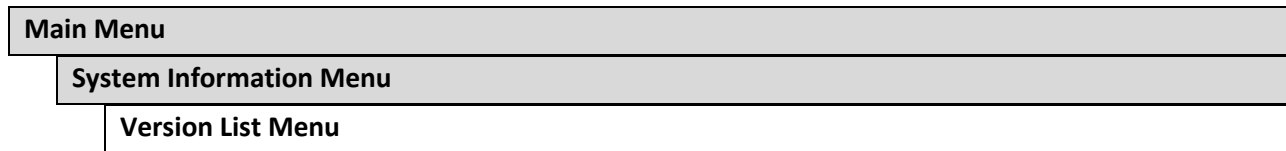
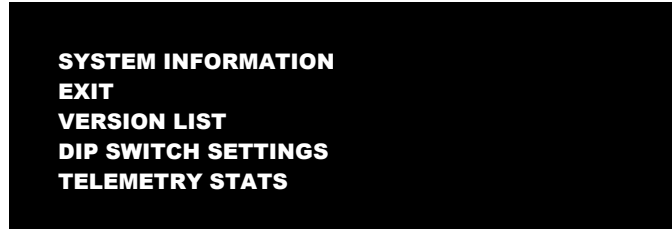

This checks the game's hardware and software versions.

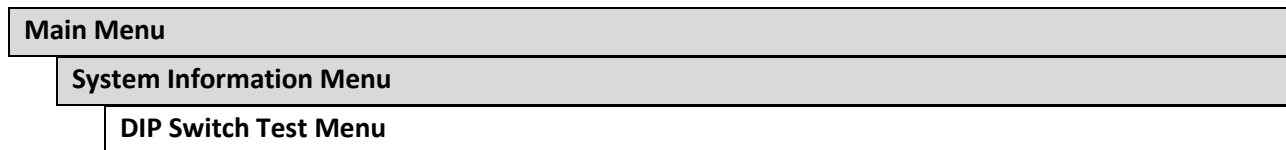

This checks the DIP Switch settings on the I/O Board



# Big Buck Hunter<sup>®</sup> Pro *Open Season*<sup>™</sup> Conversion Kit

Main Menu

System Information Menu

Telemetry Stats

These tests check thermal qualities and electrical conductivity.

## TELEMETRY DATA

EXIT	
SYSTEM TEMPERATURE	N/A
CORE TEMP1	23C
CORE TEMP2	26c
TEMPERATURE STATE	N/A
CPU FAN SPEED	N/A
CASE FAN SPEED	N/A
+3.3V:	N/A
+5.0V:	N/A
+12V:	N/A
-5.0V:	N/A
-12.0v	N/A

Main Menu

System Tests Menu

These tests check the functioning of peripherals.

## SYSTEM TESTS

- SWITCH TEST
- SCREEN TESTS
- SOUND TEST
- FILE TEST
- COIN METER TEST
- START BUTTON LAMPS
- WATCHDOG TEST
- GUN TRACKING TEST
- ETHERNET PORT TEST
- CARD TEST

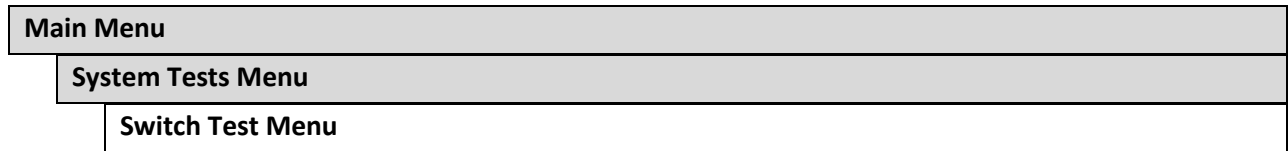

This checks input switch performance. The activated switch is highlighted on screen and the system generates a “switch active” alert sound.



The Switch Test menu has a unique exit procedure because it checks the switches normally used for navigation. To exit to the main menu, simultaneously press a Start button and squeeze a trigger.

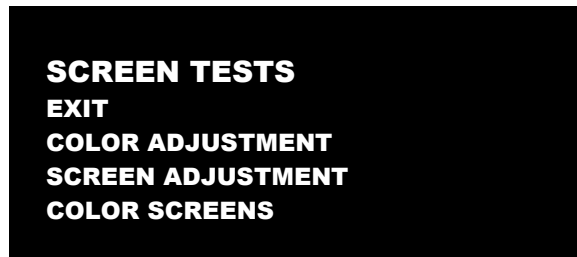
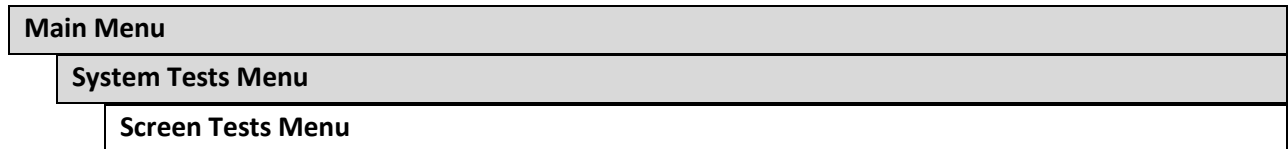

# Big Buck Hunter<sup>®</sup> Pro *Open Season*<sup>™</sup> Conversion Kit

Main Menu
System Tests Menu
Screen Tests Menu
Color Adjustment

This color bar screen of gray, yellow, cyan, green, magenta, red and blue helps identify missing colors. Missing color bars may indicate bad video RAM in the PC, or a problem with the monitor.

Color bars can also help

- Peak the brightness and black levels
- Balance red, green and blue drives
- Check purity problems (color contamination)
- Compensate for barrel or pincushion distortion
- Adjust size controls
- Test for video noise sources (such as bad cables)

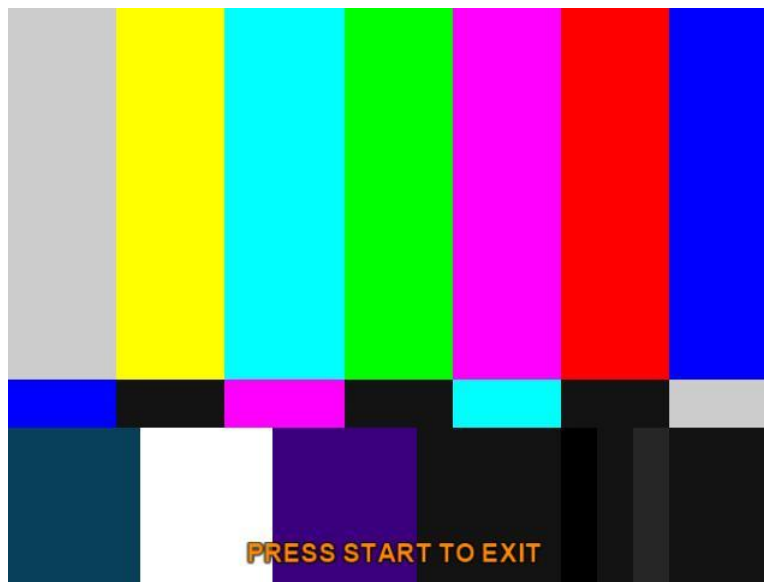

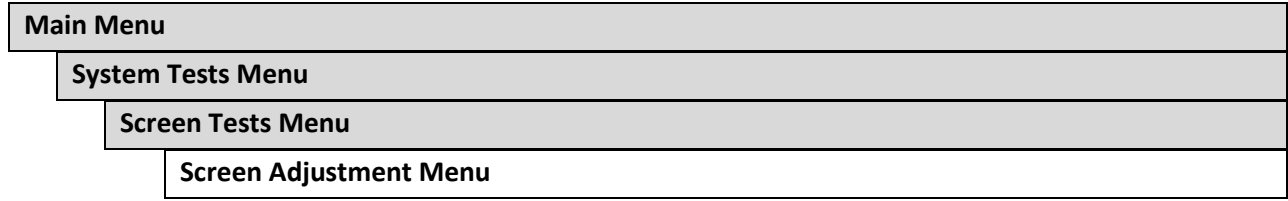

This crosshatch screen helps adjust width, height, static convergence and purity, brightness and focus.

### Width and Height

Adjust height and width of the crosshatch pattern until the grid fills the screen. Keep all the lines visible, though. If part of the grid goes off the screen, then the game image will, too.

### Static Convergence and Purity

All lines in the crosshatch pattern must be white. Else, there is a convergence or purity problem. Slight color tinges at the extreme edges of the screen are okay.

### Brightness

Ensure the bars are a fairly strong white.

### Focus

Bars with fuzzy edges indicate a focus problem. Adjust the focus control for best sharpness.

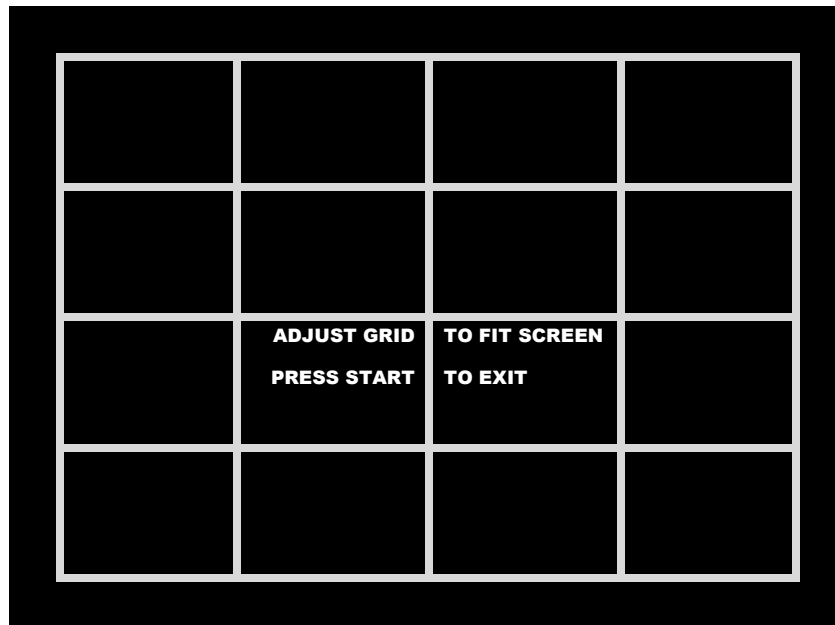

# Big Buck Hunter® Pro Open Season™ Conversion Kit

<b>Main Menu</b>
<b>System Tests Menu</b>
<b>Screen Tests Menu</b>
<b>Color Screens</b>

These are solid, one-color images that help adjust color drive controls for proper intensity. The screens are black, white, red, green and blue. Press the Start button to cycle through the screens. The white screen helps adjust brightness and color output balance.

<b>Main Menu</b>
<b>System Tests Menu</b>
<b>Sound Test Menu</b>

This checks sound volume and quality. Missing sounds indicated digital flaws. Distorted sounds suggest analog flaws. Lack of sound suggests disconnected or bad cables or speakers.

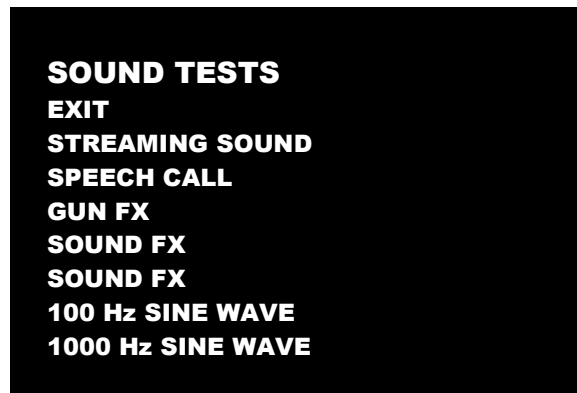

- STREAMING SOUND is a sample of the game music.
- SPEECH CALL includes talking commentary.
- GUN FX is the shotgun blast.
- The first Sound FX is a whistle.
- The second Sound FX is a guitar riff.
- 100 and 1000 Hz Sine Waves generate specific frequency sounds. Cancel these sounds by selecting another test.

<b>Main Menu</b>
<b>System Tests Menu</b>
<b>File Tests</b>

This tests the integrity of the contents of the hard drive, searching for corrupt or missing game files. Damaged or missing files register as failed and are listed. The only solution to this problem is to restore the system from the DVD-ROM, as described in the Restore the Hard Drive section.

<b>Main Menu</b>
<b>System Tests Menu</b>
<b>Coin Meter Test</b>

In this test, the System Tests Menu is the bottom-level menu. Watch the mechanical coin meter, which should increment by one count. If it does, it has passed the test. If it does not, it may not be receiving a pulse from the game. See Troubleshooting for more details.

<b>Main Menu</b>
<b>System Tests Menu</b>
<b>Start Button Lamps</b>

This tests for burned-out Start button lamps by alternately blinking the LEDs.

<b>Main Menu</b>
<b>System Tests Menu</b>
<b>Watchdog Test</b>

This tests the Watchdog circuit, which protects the game against screen freezes (infinite loops). After a countdown, the game resets. To exit before the reset, press either Start or Volume button, squeeze a trigger or pump a gun. If the test succeeds, the game resets normally. If the test fails, the reset process loops or ends abnormally. See the Troubleshooting Chapter to diagnose and correct this problem.

<b>Main Menu</b>
<b>System Tests Menu</b>
<b>Gun Tracking Test</b>

This test tracks the gun with a square and indicates the strength of the signal with color intensity on a bar graph. It also shows the x/y coordinates of where the gun is aiming. Squeeze the trigger to show how many samples are being taken,

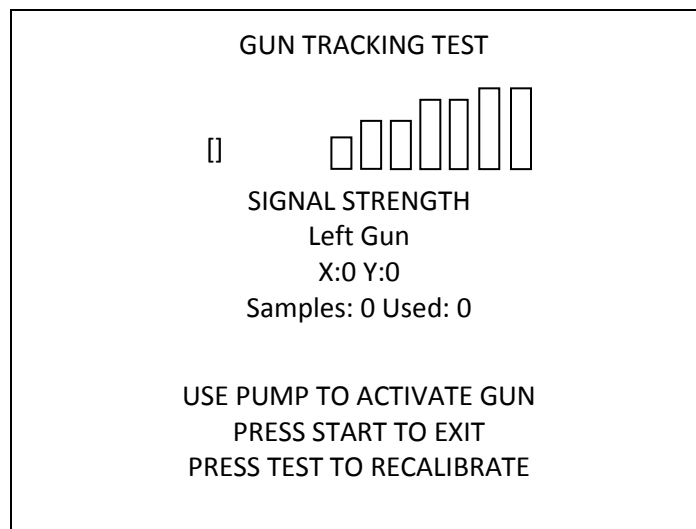



# Big Buck Hunter® Pro Open Season™ Conversion Kit

Main Menu

System Tests Menu

Ethernet Port Test

If Ethernet is used, this test sends attempts to send data packets to the server and reports on how many were received and how many were dropped. Note that running this test requires a loopback adapter.

Main Menu

System Tests Menu

Card Test

Insert a valid card to reveal the card type (player or operator) and the cardholder's name.

```
CARD TEST  
EXIT  
PLEASE INSERT CARD  
CARD FOUND:          Card Type  
NAME:                Cardholder Name
```

Main Menu

View Log Menu

This lists history of significant events or errors in file system.

Main Menu

Collections

```
COLLECTIONS  
EXIT  
SEND COLLECTIONS MESSAGE  
SHOW COINUP FEE DETAILS  
LAST COLLECTION DATE          NEVER  
GROSS COLLECTIONS            $0.00  
COINUP FEES                  $0.00  
NET COLLECTION              $0.00
```

Send Collections Message contacts the server and delivers the latest collections information.

Main Menu
Collections Menu
CoinUp Fee Details

<b>COINUP FEE DETAILS</b>	
<b>EXIT</b>	
<b>LAST COLLECTION DATE</b>	<b>2009-07-30 11:21:45</b>
<b>TROPHY CLUB PLAY</b>	<b>\$0.00</b>
<b>CUSTOM CONTEST PLAY</b>	<b>\$0.00</b>
<b>COINUP CONTEST PLAY</b>	<b>\$0.00</b>
<b>PLAYER CARD PURCHASES</b>	<b>\$0.00</b>
<b>CUSTOM CONTEST DOWNLOADS</b>	<b>\$0.00</b>
<b>COINUP CONTEST DOWNLOADS</b>	<b>\$0.00</b>
<b>CUSTOM ADVERTISEMENTDOWNLOADS</b>	<b>\$0.00</b>
<b>COINUP ADVERTISEMENT DOWNLOADS</b>	<b>\$0.00</b>
<b>COMMUNICATIONS CHARGE</b>	<b>\$0.00</b>
<b>UPGRADE CHARGE</b>	<b>\$0.00</b>
<b>TOTAL COINUP FEES</b>	<b>\$0.00</b>

# Big Buck Hunter<sup>®</sup> Pro *Open Season*<sup>™</sup> Conversion Kit

## Troubleshooting

Warning: Review safety chapter before making any adjustments to game.

Refer to the game's original manual to troubleshoot components unchanged during the conversion (monitor, coin mechanisms, etc.).

Problem	Possible Cause	Solution
Game will not power up	Game not plugged in.	Plug game into outlet.
	Game not turned on.	Turn on main power switch.
	Game fuse is blown.	Check and replace fuse.
	No power to receptacle.	Test outlet and plug game into powered outlet.
	PC not turned on.	Turn PC power switch on. Ensure IEC cable tightly plugged in. Trace cable back to source to ensure continuity.
	PC BIOS set incorrectly.	See BIOS Settings chapter.
Scrambled or scrolling display	Sync Polarity incorrect.	Change DIP switch settings for HSYNC and VSYNC.
No video display	No power to video display	Check and secure power to video display.
No sound	Bad Connection	Check connection to speakers.
Game does not load	Hard drive failure	Recover hard drive.  See procedure at end of this chapter.
Hard drive test reports "bad" or "missing" files.		
Game fails to finish loading.		
After resetting, game still reports an error.		
Game suggests inserting a boot DVD.		
Erratic game mode or attract mode.		
<p style="text-align: center;"><b>WARNING!</b> Data Files Corrupted. (Game Operation May Become Unstable.) Use "Test" Switch to Enter Test Mode and Run "File Test." Press Start To Continue.</p>		

Message	Possible Cause	Solution
Guns won't register, or function poorly	Bad calibration	Calibrate guns.
	Dirty/damaged lens	Clean gun lens.
	Bad I/O board	Mark, should they replace it?
	Gun disconnected	Check connections.
	Monitor glass dirty	Clean glass according to instructions in original game.
	Display out of adjustment	Enter display diagnostics menu and repair.
Game resets	Missing or corrupt files	Run File Test. Recover hard drive.
	Faulty hard drive or RAM	Replace and recover hard drive. See procedure at end of this chapter. Replace RAM chips.
Coin meter does not click during Test	No pulse to meter	Check all wiring from meter to I/O board
	Faulty meter	Replace coin meter
Exits Test Mode every 3 seconds	Test button stuck in ON position	Slide or toggle button off after Test Menu appears
<i>No Signal</i>	Video cable not secure.	Check and secure video connector.
	PC not turned on.	Turn PC power switch on. Ensure IEC cable tightly plugged in. Trace cable to source to ensure continuity.
	Sync Polarity incorrect.	Change DIP switch settings for HSYNC and VSYNC.
<i>Dongle Not Present</i>	Dongle missing or disconnected	Find dongle and reseat in USB port
	Faulty USB port	Insert dongle in different USB port
<i>Connect I/O Board or I/O Board Missing</i>	USB cable disconnected	Check USB connection from PC to I/O board
	No power to JAMMA I/O board	Check for proper voltage (+5V, +12V) at JAMMA connector
	I/O board faulty	Replace board
<i>Watchdog Disabled or Watchdog Failed</i>	Watchdog defeated by JAMMA I/O DIP switch	Set DIP switch 8 to OFF
	No power to Reset PCB	Connect power to Reset PCB
	Reset input to motherboard disconnected	Connect 2-pin reset connector from Reset PCB to motherboard reset pin input
	Violet or black wire from Reset PCB disconnected or faulty	Check reset wire connection to JAMMA connector.

# Big Buck Hunter® Pro Open Season™ Conversion Kit

## Hard Drive Recovery Procedure

### COMPUTER

The computer contains sensitive components, including a hard drive. Do not handle roughly. Call your distributor before servicing its internal components. Ask about warranty information as it relates to the PC.

1. With game and PC on, insert recovery DVD into DVD-ROM drive tray.
2. Close tray.
3. Turn cabinet AC power switch to OFF.
4. Wait 30 seconds, then turn AC power switch to ON.
5. When PC boots up, recovery begins automatically.  
*If recovery fails to begin, check that disc is seated properly in DVD-ROM drive tray.*
6. After 30-40 minutes, check game to see if recovery is complete.
7. When instructed to remove disk, open DVD-ROM drive tray and remove disk.
8. Turn cabinet power switch off.
9. After 30 seconds, turn cabinet power switch on.
10. Game will reboot and enter calibration mode.
11. Re-calibrate guns.

## BIOS Settings

### NOTICE

The PC ships with correct BIOS settings. Making changes to the BIOS different from the description below may adversely affect game functions.

This BIOS setting lets the PC automatically power up. With the setting enabled, the PC reboots when it detects AC power. This eliminates the need to manually turn the PC back on after power disruption.

### BIOS Adjustment Procedure

1. Turn cabinet power switch off.
2. Open rear of cabinet.
3. Connect a USB keyboard to the PC.
4. While holding the Delete key on the keyboard down, turn cabinet power switch on.
5. When the BIOS menu screen appears, make the following adjustments.

Feature .....	Set to
Standard CMOS Features > Drive A .....	[none]
Standard CMOS Features > HALT ON.....	[No Errors]
Advanced BIOS Features > Boot Sequence.....	1 <sup>st</sup> CD-ROM 2 <sup>nd</sup> Hard Disk
Advanced BIOS Features > APIC Mode .....	Disabled
Advanced Chipset Features > Frame Buffer .....	[16M]
Advanced Chipset Features > PMU > CPU Frequency .....	[200.0]
Power Management Setup > PWRON After PWR-Fail.....	[On]

6. Follow instructions on screen to save and exit.
7. PC will reset and load the game.

# Big Buck Hunter<sup>®</sup> Pro *Open Season*<sup>™</sup> Conversion Kit

## Wiring and Parts

### JAMMA I/O Board Connector Table

JAMMA Edge Connector Component Side			JAMMA Edge Connector Solder Side		
Function	Wire Color	Pin	Pin	Wire Color	Function
Ground	Black	1	A	Black	Ground
Ground	Black	2	B	Black	Ground
5 Volts	Red	3	C	Red	5 Volts
5 Volts	Red	4	D	Red	5 Volts
		5	E		
12 Volts	Orange	6	F	Orange	12 Volts
12 Volts	Orange	7	H	Orange	12 Volts
Coin Meter	Brown Yellow	8	J	Violet Brown	P1 Lamp
Reset	Violet	9	K	Violet Red	P2 Lamp
		10	L		
Speaker (+)	Brown Red	11	M	Brown Black	Speaker (-)
		12	N		
		13	P		
		14	R	Violet White	Service
Test	Blue	15	S		
Coin 1	Gray Brown	16	T	Gray Blue	Coin 2
P1 Start	White Brown	17	U	Green Brown	P2 Start
		18	V		
		19	W		
		20	X		
		21	Y		
		22	Z		
		23	a		
Volume (+)	Orange Red	24	b	Orange Green	Volume (-)
DBV	Gray Orange	25	c		
		26	d		
Ground	Black	27	e	Black	Ground
Ground	Black	28	f	Black	Ground

### Gun I/O Board Connector Table

Player 1		P4	P5	Player2	
Function	Wire Color	Pin	Pin	Wire Color	Function
5 Volts	Red	1	1	Red	5 Volts
Trigger	Yellow	2	2	Yellow	Trigger
Sensor	Green	3	3	Green	Sensor
Pump	Violet	4	4	Violet	Pump
Ground	Blue	5	5	Blue	Ground
Ground	Black	6	6	Black	Ground

### PC to Watchdog Board Wiring Diagram

DELL OPTIPLEX 740 PC

FUSE/WATCHDOG PCB

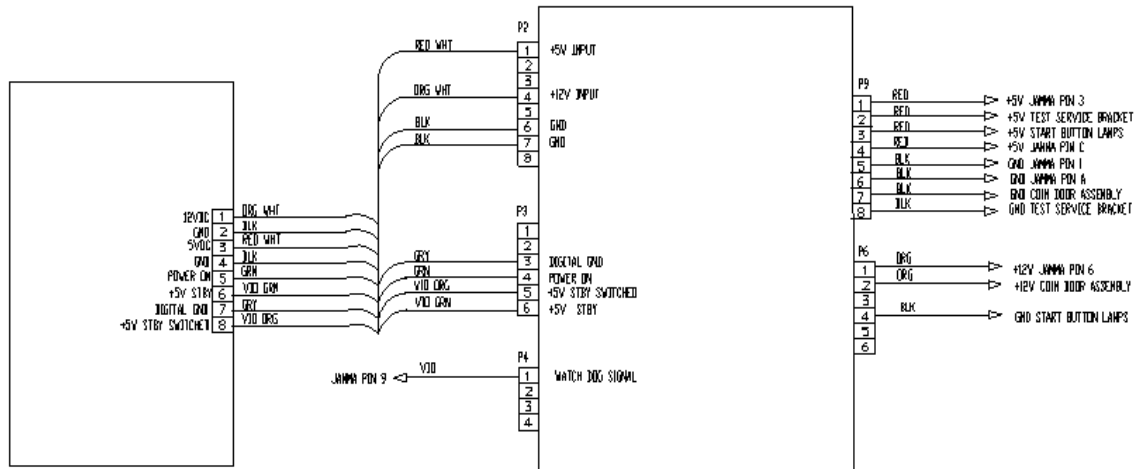



# Big Buck Hunter® Pro Open Season™ Conversion Kit

## Cabinet Wiring Diagram

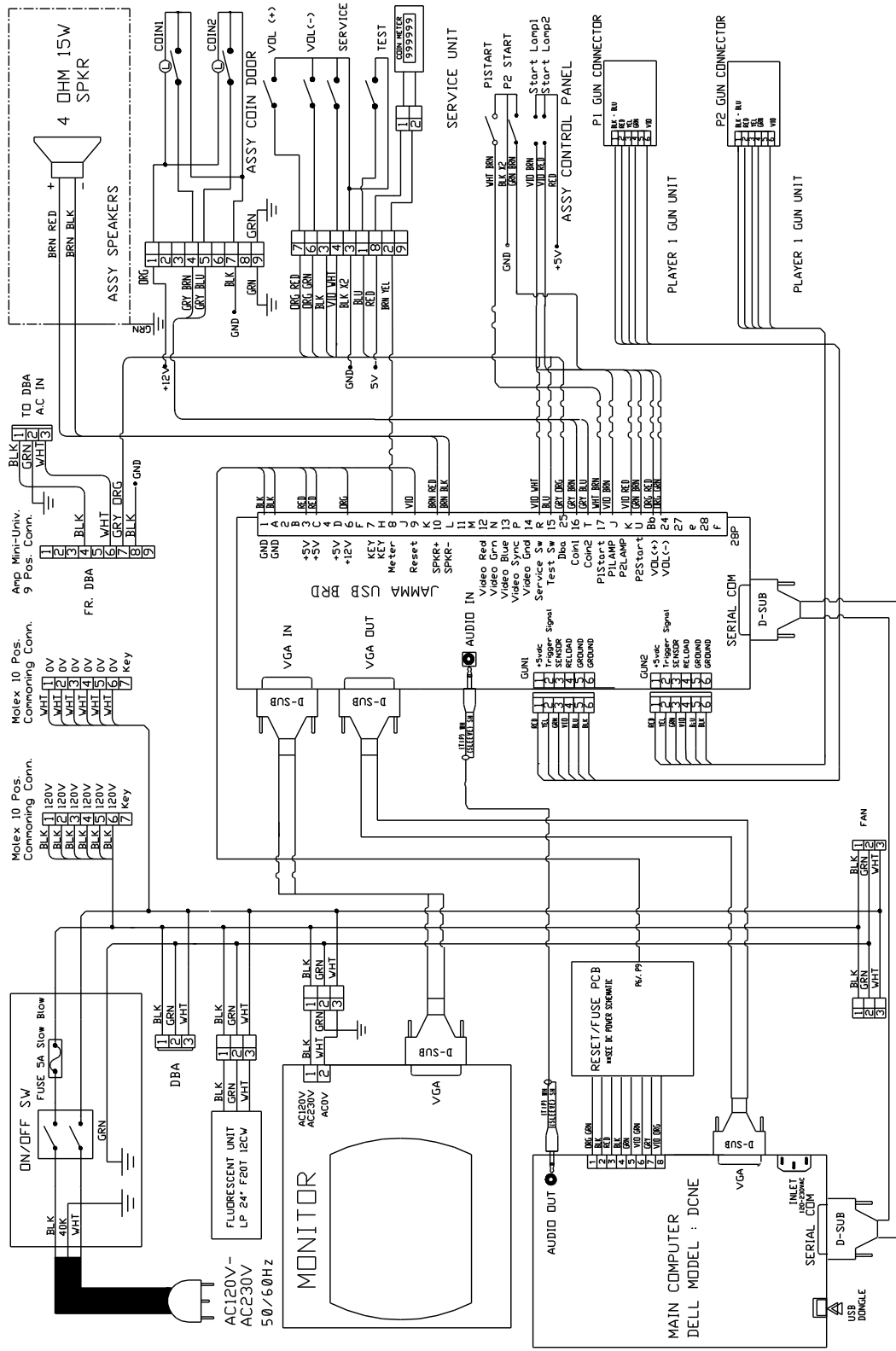

**Gun Parts**

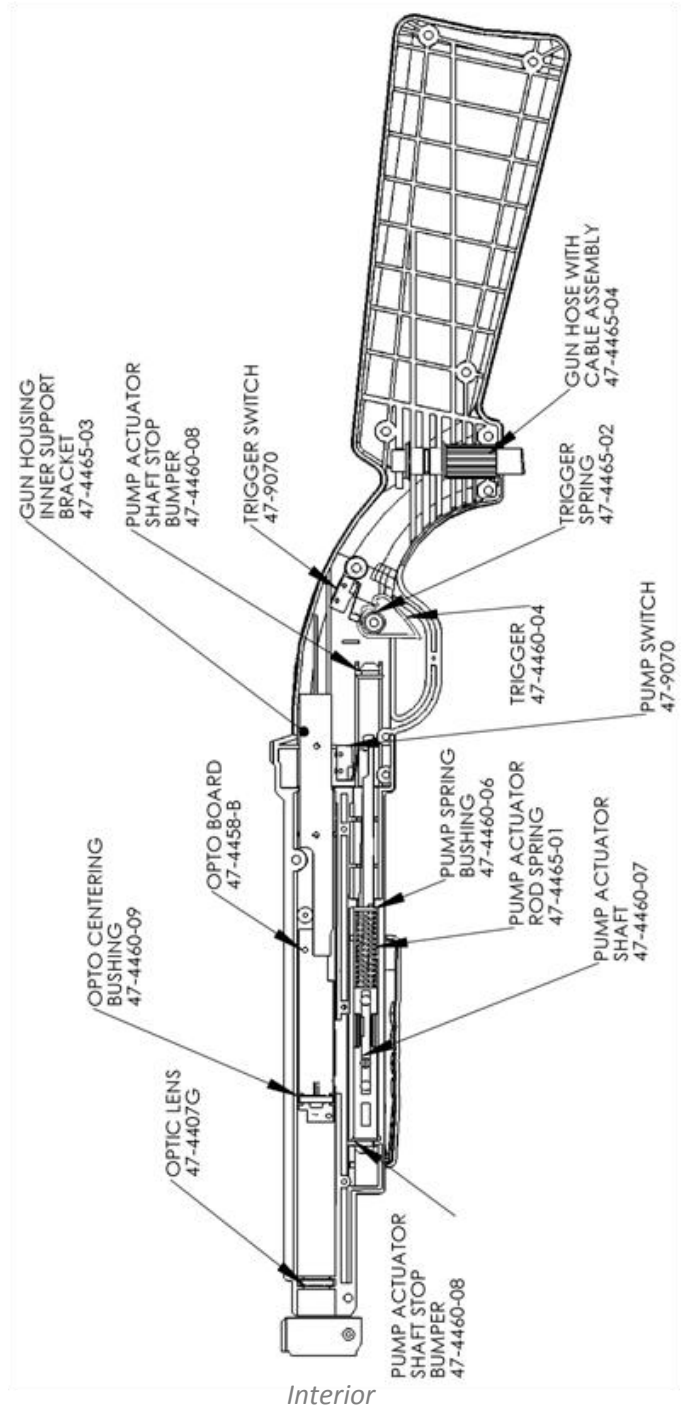
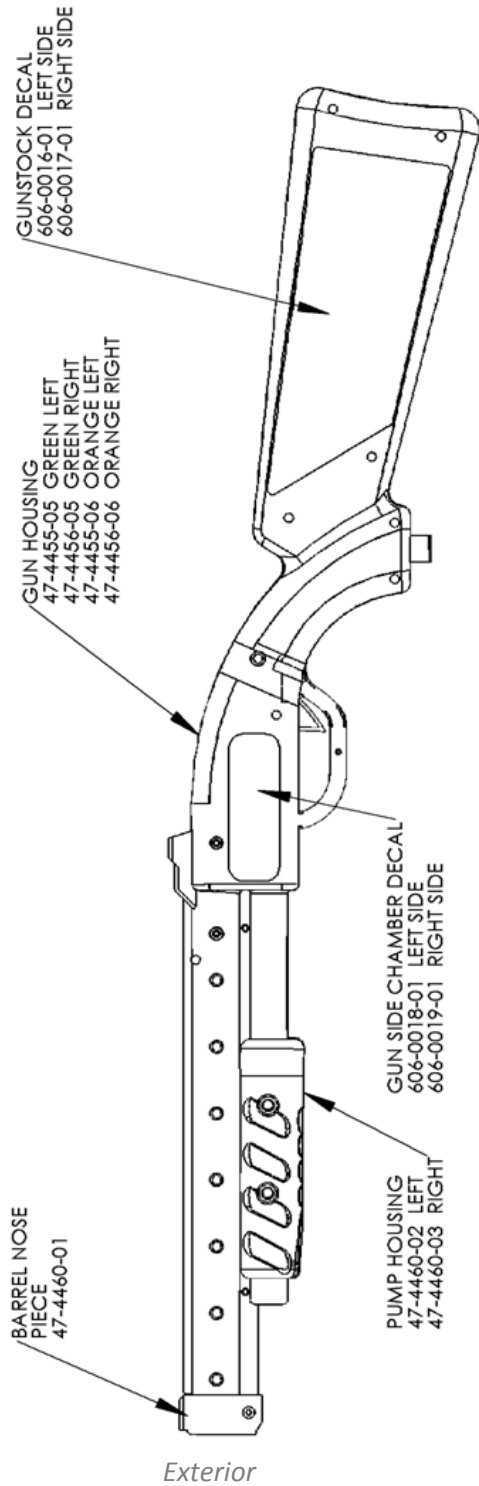

### Drilling and Mounting Templates

Gun Hook (should be 6" from front of cabinet)

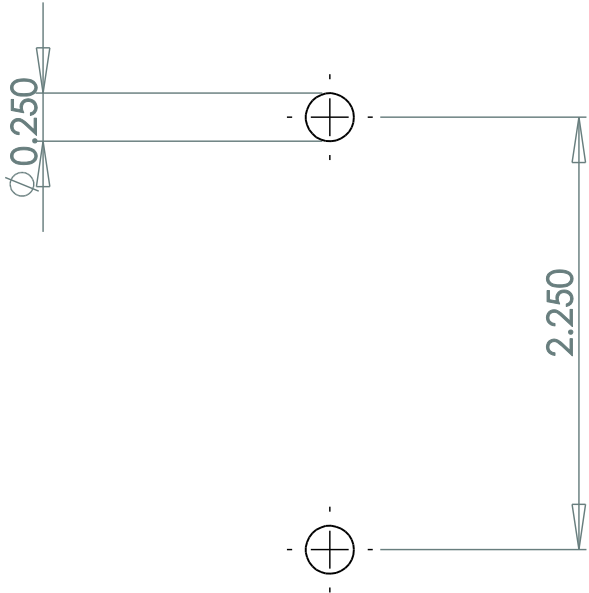

**Gun Cable and Cover Plate Mount (see reference illustration for positions on front panel)**

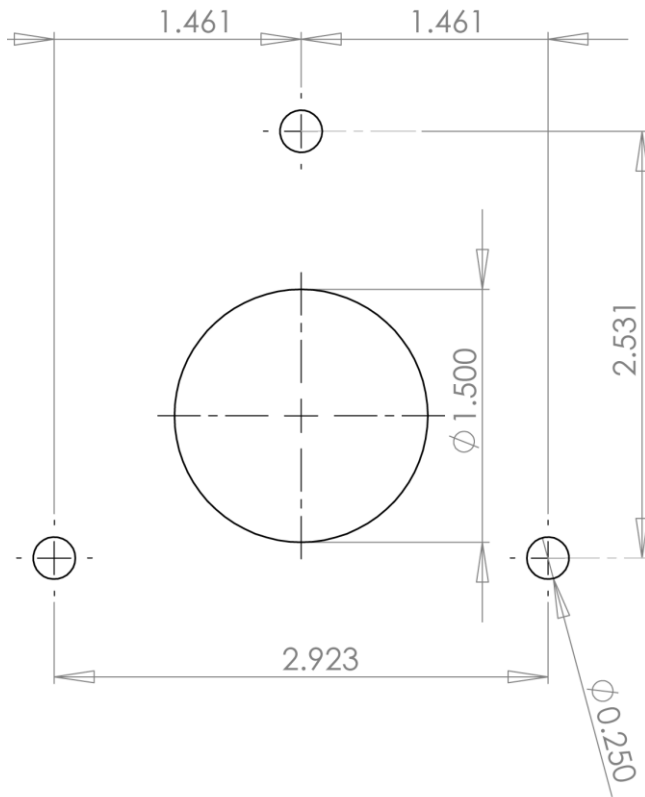

# Big Buck Hunter<sup>®</sup> Pro *Open Season*<sup>™</sup> Conversion Kit

Start Button (see reference illustration for positions on control panel)

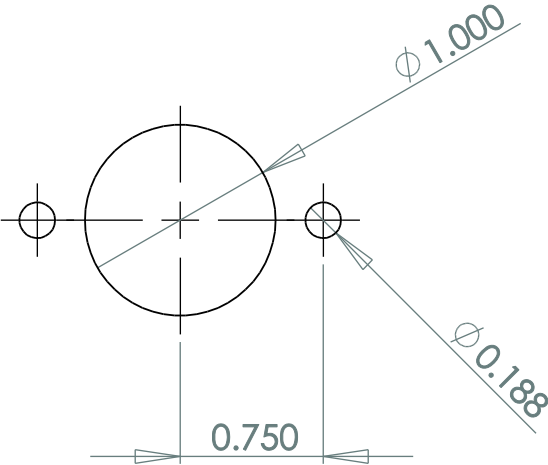

## Service Contacts

For an authorized distributor near you, check the Raw Thrills website at [www.rawthrills.com](http://www.rawthrills.com)

Contact Betson Enterprise Headquarters or your local Betson office for sales, technical information, warranty or repair. Betson can be reached at (800) 524-2343 Fax (201) 438-4837 [www.betson.com](http://www.betson.com)

**CoinUp® Prize Claims or Service**

PlayMechanix™ [www.playmechanix.com](http://www.playmechanix.com)

800 Roosevelt Road, Suite D-103

Glen Ellyn, IL 60137

(866) 646-1975 fax (630) 942-1073

**Betson West – Phoenix**

2633 N. 37th Ave. Suite 7

Phoenix, AZ 85009

(602) 442-6630 Fax (602) 442-9501

**Betson Philadelphia Distributing**

310 Hansen Access Rd.

King of Prussia, PA. 19406

(610) 265-1155 fax (610) 265-0909

**Betson West-Buena Park**

5660 Knott Ave.

Buena Park, CA 90621

(714) 228-7500 fax (714) 228-7515

**Betson Midwest**

1158 Tower Lane

Bensenville, IL 60106

(630) 238-9400 Fax (630) 238-9409

**Betson West**

3470 Depot Road

Hayward, CA 94545

(510) 293-9127 or (800) 526-7906

fax( 510) 785-5317

**Betson Enterprises Headquarters**

303 Paterson Plank Rd.

Carlstadt, NJ 07072

(800) 524-2343 or (201) 438-1300

fax (201) 438-4837

**Betson New England**

560 Turnpike St.

Canton, MA 02021

(781) 821-8533 or (800) 274-6326

fax (781) 821-9082

**Betson Advance Distributing**

6743 Thompson Rd.

Syracuse, NY 13211

(315) 437-2400 Fax (315) 437-6130

**Betson Pittsburgh Distributing**

2707 West Carson St.

Pittsburgh, PA 15204

(412) 331-8703 fax (412) 331-0712

**Betson Baltimore Distributing**

3431-A Benson Ave.

Baltimore, MD 21227

(410) 646-4100 Fax (410) 646-7753

**Betson Texas Distributing**

1127 Conveyor Lane

Dallas, TX 75247

(214) 638-4900 or (877) 638-4900

Fax (214) 638-4925