

# Copper-fin II/IE Boiler and Water Heater Service Manual Models: 402 - 2072



**Lochinvar**<sup>®</sup>  
High Efficiency Water Heaters, Boilers and Pool Heaters

**⚠ WARNING**

This manual must only be used by a qualified heating installer / service technician. Read all instructions, including this manual and the Installation and Operation Manual, before installing. Perform steps in the order given. Failure to comply could result in severe personal injury, death, or substantial property damage.

Save this manual for future reference.

# Contents

<b>CONTENTS</b> .....	2	<b>2. MAINTENANCE</b>	
Hazard Definitions.....	2	Maintenance and Annual Startup.....	25-32
<b>PLEASE READ BEFORE PROCEEDING</b> .....	3	<b>3. TROUBLESHOOTING</b>	
Handling Ceramic Fiber Materials.....	3	Before Troubleshooting.....	33
When servicing appliance.....	3	Check Control Module Fuses .....	33
Appliance operation.....	3	Table 3A - Troubleshooting Chart - No Display.....	34
Appliance water.....	3	Checking Temperature Sensors .....	35
WHAT IS IN THIS MANUAL .....	4	Table 3D - Troubleshooting Chart - Noisy System.....	36
<b>1. SERVICE</b>		Table 3E - Troubleshooting Chart - Fault Messages..	37-43
The Copper-fin Display .....	5	Revision Notes .....	Back Cover
Control Inputs.....	6		
Control Outputs.....	7		
General Operation .....	8		
Sequence of Operation .....	9-10		
Display Panel Menu Access .....	11		
Display Panel Parameter Access.....	12		
Parameter Table A - Boiler Operation .....	13-14		
Parameter Table B - Water Heater Operation .....	15-16		
Viewable and Changeable Control Parameters.....	17-24		

## Hazard definitions

The following defined terms are used throughout this manual to bring attention to the presence of hazards of various risk levels or to important information concerning the life of the product.

### **DANGER**

DANGER indicates an imminently hazardous situation which, if not avoided, will result in death or serious injury.

### **WARNING**

WARNING indicates a potentially hazardous situation which, if not avoided, could result in death or serious injury.

### **CAUTION**

CAUTION indicates a potentially hazardous situation which, if not avoided, may result in minor or moderate injury.

### **CAUTION**

CAUTION used without the safety alert symbol indicates a potentially hazardous situation which, if not avoided, may result in property damage.

### **NOTICE**

NOTICE indicates special instructions on installation, operation, or maintenance that are important but not related to personal injury or property damage.

## Please read before proceeding

### ⚠ WARNING

**Installer** – Read all instructions, including this manual and the Installation and Operation Manual, before installing. Perform steps in the order given.

**User** – This manual is for use only by a qualified heating installer/service technician. Refer to the User's Information Manual for your reference.

Have this appliance serviced/inspected by a qualified service technician at least annually.

Failure to comply with the above could result in severe personal injury, death or substantial property damage.

### NOTICE

When calling or writing about the appliance – Please have the appliance model and serial number from the appliance's rating plate.

Consider piping and installation when determining appliance location (see the Installation and Operation Manual).

Any claims for damage or shortage in shipment must be filed immediately against the transportation company by the consignee.

### When servicing appliance –

- To avoid electric shock, disconnect electrical supply before performing maintenance.
- To avoid severe burns, allow appliance to cool before performing maintenance.

### Appliance operation –

- Do not block flow of combustion or ventilation air to the appliance.
- Should overheating occur or gas supply fail to shut off, do not turn off or disconnect electrical supply to circulator. Instead, shut off the gas supply at a location external to the appliance.
- Do not use this appliance if any part has been under water. The possible damage to a flooded appliance can be extensive and present numerous safety hazards. Any appliance that has been under water must be replaced.

### Appliance water –

- Thoroughly flush the system (without appliance connected) to remove sediment. The high-efficiency heat exchanger can be damaged by build-up or corrosion due to sediment.
- Do not use petroleum-based cleaning or sealing compounds in the appliance system. Gaskets and seals in the system may be damaged. This can result in substantial property damage.
- Do not use “homemade cures” or “appliance patent medicines”. Serious damage to the appliance, personnel, and/or property may result.

## Handling ceramic fiber materials

### REMOVAL OF COMBUSTION CHAMBER LINING

### ⚠ WARNING

The combustion chamber insulation in this appliance contains ceramic fiber material. Ceramic fibers can be converted to cristobalite in very high temperature applications. The International Agency for Research on Cancer (IARC) has concluded, “Crystalline silica in the form of quartz or cristobalite from occupational sources is carcinogenic to humans (Group 1).” Normal operating temperatures in this appliance are below the level to convert ceramic fibers to cristobalite. Abnormal operating conditions would have to be created to convert the ceramic fibers in this appliance to cristobalite.

The ceramic fiber material used in this appliance is an irritant; when handling or replacing the ceramic materials it is advisable that the installer follow these safety guidelines.

- Avoid breathing dust and contact with skin and eyes.

- Use NIOSH certified dust respirator (N95). This type of respirator is based on the OSHA requirements for cristobalite at the time this document was written. Other types of respirators may be needed depending on the job site conditions. Current NIOSH recommendations can be found on the NIOSH website at <http://www.cdc.gov/niosh/homepage.html>. NIOSH approved respirators, manufacturers, and phone numbers are also listed on this website.

- Wear long-sleeved, loose fitting clothing, gloves, and eye protection.

- Apply enough water to the combustion chamber lining to prevent airborne dust.
- Remove the combustion chamber lining from the appliance and place it in a plastic bag for disposal.
- Wash potentially contaminated clothes separately from other clothing. Rinse clothes washer thoroughly.

### NIOSH stated First Aid.

- Eye: Irrigate immediately.
- Breathing: Fresh air.

## What is in this manual?

### Service

#### The Copper-fin display

- Display panel readout, buttons and their functions

#### Control module inputs

- Control module inputs and options

#### Control module outputs

- Control module outputs and options

### General

- How the appliance operates
- How the control module operates
- Access modes -- user and installer
- Sequence of operation -- Domestic Hot Water (DHW)/space heating

#### Control panel menu access

- Accessing programming mode and locating menus  
(See separate guides covering the ModBus and PC interfaces)

#### Control panel parameter access

- Accessing and changing parameters from the display panel

#### Quick start information -- parameter tables

- An index of available adjustments and readouts, where to access them and where to find detailed information.

#### Copper-fin boiler operation *(pages 13 - 14)*

- A: General
- B: Temperature Settings
- C: Data Logging
- D: Functions
- E: DHW Settings
- F: Outdoor Air Reset
- G: Anti-cycling
- H: Control Modes
- I: Cascade
- J: Building Management System (BMS)
- K: Pumps
- L: Service Notification

#### Copper-fin water heater operation *(pages 15 - 16)*

- A: General
- B: Temperature Settings
- C: Data Logging
- D: Functions
- E: DHW Settings
- F: Anti-cycling
- G: Control Modes
- H: Cascade
- I: Building Management System (BMS)
- J: Pumps
- K: Service Notification

### Maintenance

- Service and maintenance schedules
- Address reported problems
- Inspect appliance area and appliance interior
- Check all piping for leaks
- Flue vent system and air piping
- Combustion air filter
- Check water system
- Check expansion tank
- Check relief valve
- Check igniter
- Check all appliance wiring
- Flame inspection
- Check flue gas passageways
- Inspect and clean burner
- Checking combustion air pressure
- Checking manifold gas pressure
- Cleaning heat exchanger
- Review with owner

### Troubleshooting

- Troubleshooting table - No display
- Checking temperature sensors
- Troubleshooting table - Noisy system
- Troubleshooting table - Fault messages displayed on Operator Interface

# 1 Service

## The Copper-fin display

- Hold 5 seconds to enter code Input Mode (Menu Mode)
- Press to move up one level in Menu Mode or to exit Menu Mode

- 2-Line / 16 character LCD display
- Backlit LCD

- Press to turn heater off or back on
- Press to select a menu item
- Press after parameter programming to store parameter data
- Press to exit Service Mode

MENU/EXIT

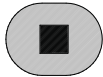

DISPLAY SCREEN

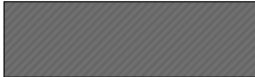

ENTER/RESET

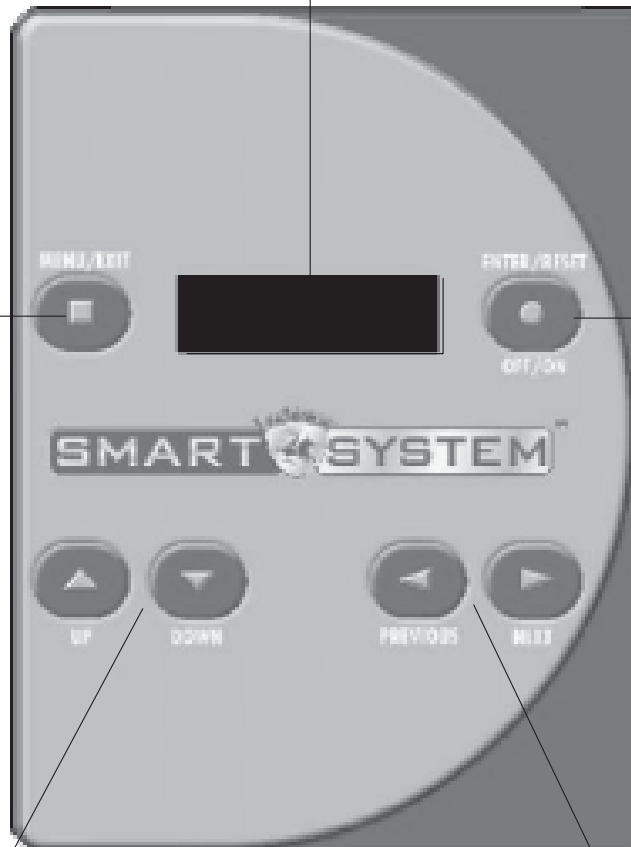
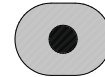

UP



DOWN

- Press to change boiler water temperature and/or tank water temperature set point during normal operation
- Press to change displayed data values in Menu Mode
- Press to navigate through menu listing in Menu Mode



PREVIOUS



NEXT

- Press to toggle display during normal operation to show outlet and return temperatures, fan speed, flame signal, etc.
- Press to toggle between digits when entering access code or between hour, minutes, etc., when entering date and time
- Press and hold both to enter Service Mode

# 1 Service

## Control inputs

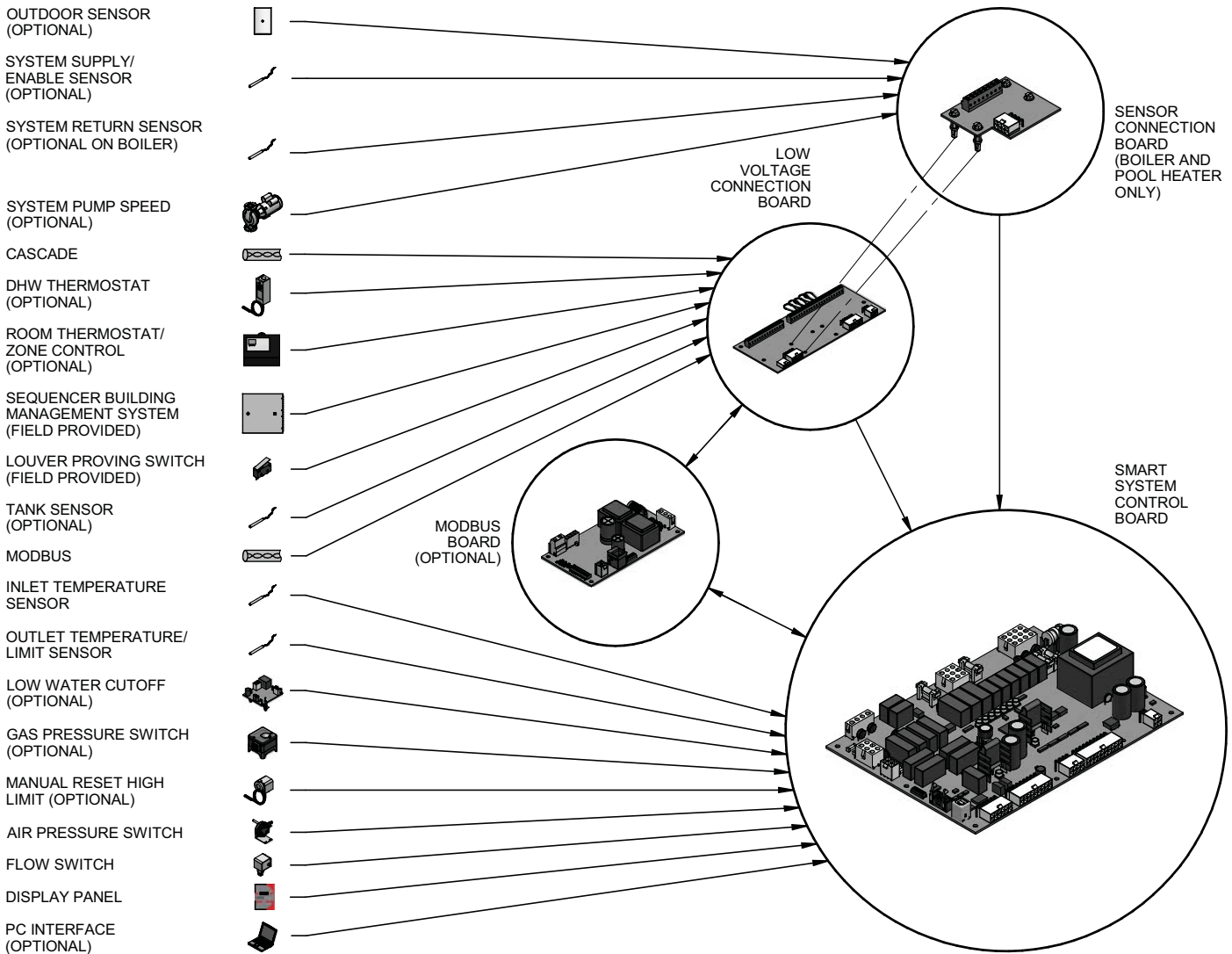

# 1 Service *(continued)*

## Control outputs

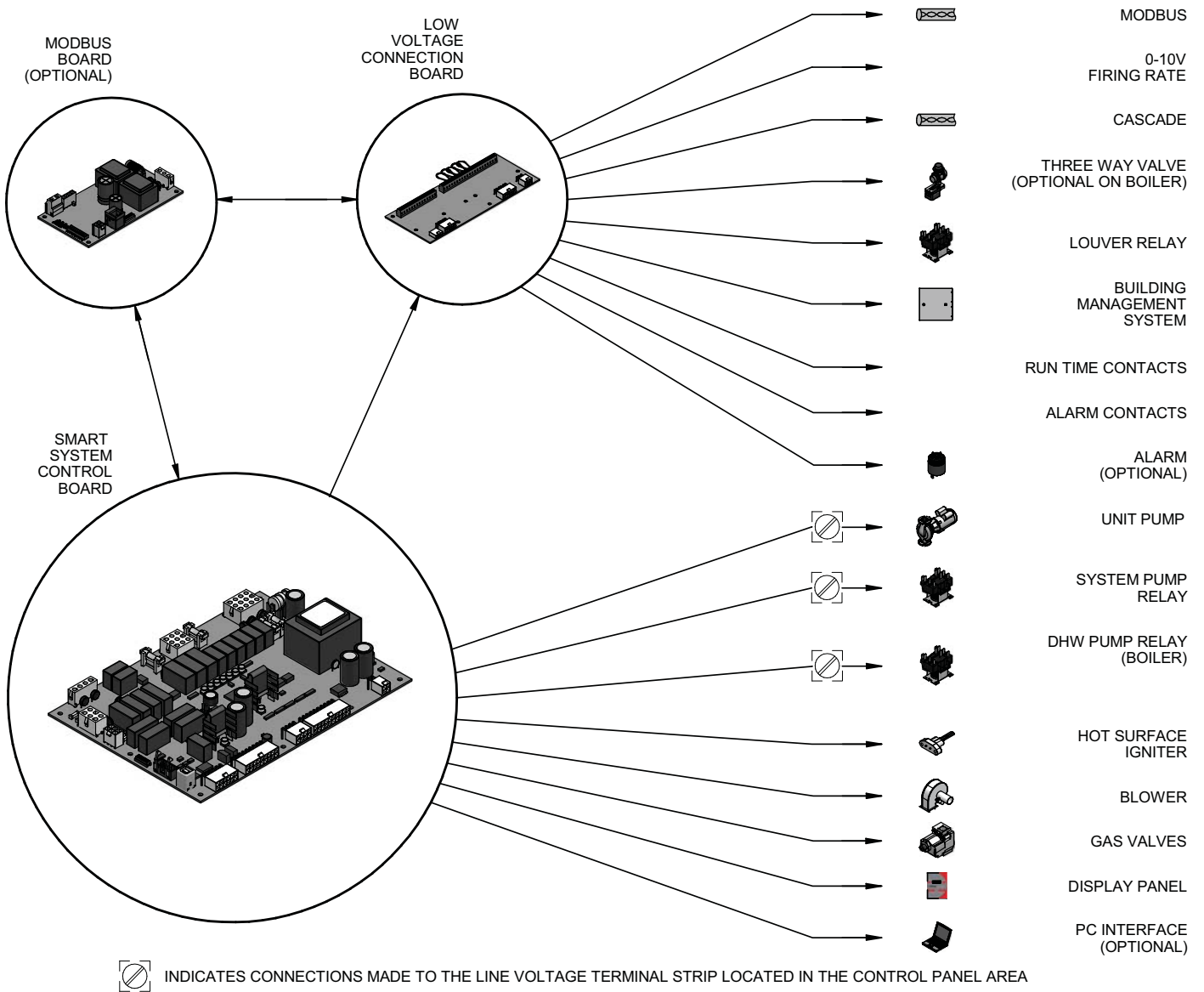

# 1 Service

## General Operation

### How the appliance operates

The Copper-fin uses a finned copper tube heat exchanger to transfer heat from the flue products to the water. An electronic control module monitors various inputs to initiate a call for heat. The blower provides both primary and secondary air to the burner and forces the flue products out of the combustion chamber and into the vent system.

### How the control module operates

The Copper-fin control module receives input from appliance sensors. The control module activates and controls the blower and gas valves to regulate heat input and switches heater, DHW and system pumps on and off as needed. The user/installer programs the module to meet system needs by adjusting control parameters. These parameters set operating temperatures and heater operating modes. Appliance operation can be based on heater outlet water temperature, heater return water temperature, system supply temperature, system return temperature or tank temperature, depending on the parameter setting.

### Sequence of operation

Table 1A shows control module normal sequences of operation for space heating and DHW operation. The combined operation sequence is for a typical application, programmed to provide DHW priority.

### Access modes

#### *User*

The user can adjust space heating and/or tank setpoints using the UP and DOWN buttons at any time during normal operation. By entering the USER code (0704), the user can also change temperature units, time and date, and night setback settings. In user mode, the following parameters can be viewed but not changed: Heater outlet water temperature in DHW mode; heater model number; software version; total operating hours, and total cycles.

#### *Installer*

Most parameters are available only to the installer, accessible only by entering the installer access code (5309).

### Saving parameters

#### **To save parameters and exit programming:**

Press the ENTER/RESET button, then the MENU/EXIT button 3 times.

#### **To keep parameter settings only for a current operating cycle:**

Press the MENU/EXIT button 3 times after making all desired parameter changes.

#### **To enter a parameter and continue programming:**

Press the MENU/EXIT button 1 time to return to the parameter listings; press again to return to the menu listings. Remember to press the ENTER/RESET button when finished programming in order to save the changes made.



# 1 Service *(continued)*

## Sequence of operation

**Table 1A** Sequence of Operation - Space Heating and DHW

OPERATION	DISPLAY
1. The manual reset high limit must be closed before any action will take place.	HTR: Standby OUT: 123.8F (129)
2. Upon a call for heat the control turns on the appropriate pumps (system and boiler pumps for space heating; DHW pump for DHW call). The flow switch and low water cutoff (if equipped) must close.	HTR: Standby OUT: 123.8F (129)
3. <ul style="list-style-type: none"> <li>• The gas pressure switch(es) (if equipped) must close.</li> <li>• The louver proving input must close.</li> <li>• If the air pressure switch is open, the prepurge cycle then begins by starting the combustion blower. Once started, the air pressure switch must close.</li> </ul>	HTR: Standby OUT: 123.8F (129)
4. After the 15 second prepurge, the blower slows down and the hot surface igniter (HSI) is energized. The HSI is heated for at least 20 seconds.	HTR: PREPURGE OUT: 123.9F (129)
5. Once the HSI is hot, the trial for ignition begins with the opening of the gas valve.	HTR: IGNITION OUT: 123.9F (129)
6. If the SMART SYSTEM control does not sense flame, then it will lock out.	HTR: POSTPURGE, PREPURGE OUT: 123.9F (129)
7. If the SMART SYSTEM control senses flame, it will fire the burner to maintain the setpoint. The stages will fire as required to hold the actual temperature at the setpoint.	HTR: RUN STG: 1 OUT: 124.8F (129)
8. If the space heating call for heat is active, and the DHW thermostat closes, the control will turn on the DHW pump, wait 2 seconds, and then turn off the boiler pump. This will divert the hot water away from the heating zone(s) and send it to the DHW tank instead. The control will then fire the stages to maintain the outlet temperature to the DHW boiler setpoint.	HTR: DHW STG 123 OUT: 177.8 (180)

# 1 Service

## Sequence of operation















**Table 1A\_** (continued from previous page) *Sequence of Operation - Space Heating and DHW*

OPERATION	DISPLAY
9. If the DHW thermostat remains on for more than 30 minutes, and the space heating call for heat is also on, then the control will turn on the boiler pump, turn off the DHW pump after 2 seconds, and resume firing based on the space heating setpoint. As long as both the space heating and DHW calls for heat remain active, the control will switch back and forth between the two modes until one of them is satisfied.	HTR: RUN STG 12 OUT: 123.0F(129)
10. Once both calls for heat are satisfied, the control will turn off the burners. The blower will remain on for the 30 second postpurge cycle. Any pumps that are running will continue to run for their respective pump delay times, then turn off.	HTR: POSTPURGE OUT: 127.4F(129)
11. Boiler pump off, system pump continues its delay if longer.	HTR: Standby OUT: 124.7F(129)
12. System pump off.	HTR: Standby OUT: 122.9F(129)

# 1 Service *(continued)*

## Display panel menu access

**Table 1B** Use this procedure to access menus from the display panel

BUTTON	OPERATION	DISPLAY	COMMENTS
	ENTER/RES Press 1 time in normal operation	HTR: OFF OUT: 123.0F	Heater turns off (this ensures uninterrupted programming)
	MENU/EXIT Hold for 5 seconds -- display will change	Enter Menu Code: 000 <u>0</u> ← flashing	Digit shown underlined at left will flash
	UP Press 9 times to change last digit in readout to "9"	Enter Menu Code: 000 <u>9</u>	Digit shown underlined at left will flash
	PREVIOUS Press 2 times to move to the second digit	Enter Menu Code: 0 <u>0</u> 9	Digit shown underlined at left will flash
	UP Press 3 times to change second digit in readout to "3"	Enter Menu Code: 0 <u>3</u> 9	Digit shown underlined at left will flash
	PREVIOUS Press 1 time to change to the first digit	Enter Menu Code: <u>0</u> 39	Digit shown underlined at left will flash
	UP Press 5 times to change first digit in readout to "5"	Enter Menu Code: <u>5</u> 39	Digit shown underlined at left will flash
<i>If you enter a digit incorrectly, you can move to the digit by using the NEXT and PREVIOUS buttons as needed until the digit you want is flashing. Then use UP and/or DOWN buttons to change the value.</i>			
	ENTER/RES Press to enter the code	Enter Menu Code: INSTALLER CODE	The words, "INSTALLER CODE" will flash while displayed
	After 2 seconds, display shows menus (press ENTER/RESET to select a menu)	>A General B Temp Settings	The caret symbol, ">" highlights the selectable line
<i>If the code is entered incorrectly, the display will return to its previous mode. You will have to start over at step 1 to enter the code.</i>			
	DOWN Press 1 time to highlight second listing	A General >B Temp Settings	The caret symbol, ">" highlights the selectable line
	DOWN Press 1 time to toggle menu listing	>C Data Logging D Functions	The menu toggles to the next two menu options
	DOWN Press 2 times to toggle menu listing	>E DHW Settings F Outdoor Reset	The menu toggles to the next two menu options
	DOWN Press 2 times to toggle menu listing	>G Anti-cycling H Control Modes	The menu toggles to the next two menu options
	DOWN Press 2 times to toggle menu listing	>I Cascade J BMS	The menu toggles to the next two menu options
<i>To select a highlighted menu, press the ENTER/RESET button one time. The display will change to the first parameter under that menu, with the first characters flashing.</i>			

**Note:** Not all menu listings shown above are available on water heaters.

# 1 Service

## Display panel parameter access

**Table 1C\_** This is a typical example of accessing a parameter, shown for parameter K2, SH pump delay

BUTTON	OPERATION	DISPLAY	COMMENTS	
<i>This example shows how to access parameter K2, SH pump delay. The first display shown is at the beginning of the menu listings, after entering the installer access code.</i>				
-	Beginning of menu listings.	>A General B Temp Settings	The caret symbol, ">" highlights the selectable line	
▼	DOWN	Press 1 time to highlight second listing	>A General B Temp Settings	The caret symbol, ">" highlights the selectable line
▼	DOWN	Press 1 time to toggle menu listing	>C Data Logging D Functions	The menu toggles to the next two menu options
▼	DOWN	Press 2 times to toggle menu listing	>E DHW Settings F Heat Curve	The menu toggles to the next two menu options
▼	DOWN	Press 2 times to toggle menu listing	>G Anti-Cycling H Control Modes	The menu toggles to the next two menu options
▼	DOWN	Press 2 times to toggle menu listing	>I Cascade J BMS	The menu toggles to the next two menu options
▼	DOWN	Press 2 times to toggle menu listing	>K Circ. Pump L Service Noti.	The menu toggles to the next two menu options
●	ENTER/RES	Press 1 time to list parameters	K1 SYS Pump Dely	K1 will flash
▲	UP	Press 1 time to change parameter	K2 SH Pump Dely	K2 will flash
●	ENTER/RES	Press 1 time to select parameter	K2 SH Pump Dely 30 Seconds	K2 will stop flashing; parameter value will appear
▲	UP (or DOWN)	Press to increase (or decrease) value	K2 SH Pump Dely 40 Seconds	Parameter will increase or decrease, depending on button pressed
●	ENTER/RES	Press 1 time to save (or press MENU/EXIT to continue)	K2 SH Pump Dely	K2 will flash
■	MENU/EXIT	Press 1 time to return to the main menu	> A General B Temp Settings	
■	MENU/EXIT	Press 1 time to return to normal operation	HTR: Pre-Purge OUT: 123.7 °F	This display example assumes a call for space heating is present

# 1 Service *(continued)*

## Parameter table A - Boiler Operation

**Table 1D** This table lists SMART SYSTEM control module parameters and where to access them for boiler operation ONLY

	Menu	Sub Item	Description	See Page	User Access		Installer Access	
					Display	Modify	Display	Modify
GENERAL	A	1	User Code	17	Yes	Yes	Yes	Yes
		2	Date and Time	17	Yes	Yes	Yes	Yes
		3	Software Version (Software Ver)	17	Yes	No	Yes	Yes
		4	Temperature Units (Temp Units)	17	Yes	Yes	Yes	Yes
		5	SH Night Setback Offset (SH NSB Temp)	17	Yes	Yes	Yes	Yes
		6	SH Night Setback Times (SH NSB Time)	17	Yes	Yes	Yes	Yes
		7	DHW Night Setback Offset (DHW NSB Temp)	17	Yes	Yes	Yes	Yes
		8	DHW Night Setback Times (DHW NSB Time)	17	Yes	Yes	Yes	Yes
TEMPERATURE SETTINGS	B	1	SH Setpoint (SH Setpoint)	17	Yes	Yes	Yes	Yes
		2	SH Minimum Setpoint (SH Min Setpt)	17	No	No	Yes	Yes
		3	SH Maximum Setpoint (SH Max Setpt)	18	No	No	Yes	Yes
		4	SH Offset	18	No	No	Yes	Yes
		5	SH Differential (SH Differentl)	18	No	No	Yes	Yes
		6	Manual Reset High Limit (Man Res Hi Lim)	18	Yes	Yes	Yes	Yes
		7	Auto Reset High Limit (Aut Res Hi Lim)	18	Yes	Yes	Yes	Yes
DATA LOGGING	C	1	Hours Running SH (Hours Run SH)	18	No	No	Yes	Yes
		2	Hours Running DHW (Hours Run DHW)	18	No	No	Yes	Yes
		3	Ignition Attempts (Ign Attempts)	18	No	No	Yes	Yes
		4	Last 10 Lockouts	18	No	No	Yes	Yes
FUNCTIONS	D	1	Clear Error Log (Clr Error Log)	18	No	No	Yes	Yes
		2	Service Mode Delay (Service Delay)	18	No	No	Yes	Yes
		3	Display Timeout (Display Time)	18	No	No	Yes	Yes
		4	Bypass Valve Time (Bypass V Time)	18	No	No	Yes	Yes
		5	Freeze Protection Pump On (Freeze Pump)	19	No	No	Yes	Yes
		6	Freeze Protection Burner On (Freeze Burn)	19	No	No	Yes	Yes
		7	Freeze Protection Differential (Freeze Differ)	19	No	No	Yes	Yes
DHW SETTINGS	E	1	Tank Setpoint	19	Yes	Yes	Yes	Yes
		2	DHW Boiler Setpoint (DHW Blr Setp)	19	Yes	Yes	Yes	Yes
		3	SH/DHW Switching Time (SH/DHW Switch)	19	Yes	Yes	Yes	Yes
		4	DHW/SH Switching Time (DHW/SH Switch)	19	Yes	Yes	Yes	Yes
		5	DHW Tank Differential (DHW Tank Diff)	19	No	No	Yes	Yes
OUTDOOR RESET	F	1	Minimum Outdoor Temperature (Min Air Temp)	20	No	No	Yes	Yes
		2	Maximum Outdoor Temperature (Max Air Temp)	20	No	No	Yes	Yes
		3	Maximum SH Setpoint (Max SH Setpt)	20	No	No	Yes	Yes
		4	Minimum SH Setpoint (Min SH Setpt)	20	No	No	Yes	Yes
		5	Outdoor Shutdown Setpoint (Outdoor Shtdn)	20	Yes	Yes	Yes	Yes
		6	Outdoor Shutdown Differential (Shutdown Diff)	21	Yes	Yes	Yes	Yes
		7	Shift Reset Curve (Shift Reset)	21	No	No	Yes	Yes
		8	Boost Temperature (Boost Temp)	21	Yes	Yes	Yes	Yes
		9	Boost Time	21	Yes	Yes	Yes	Yes

# 1 Service

## Parameter table A - Boiler Operation *(continued)*

**Table 1D\_** *(continued from previous page)* This table lists SMART SYSTEM control module parameters and where to access them for boiler operation ONLY

	Menu	Sub Item	Description	See Page	User Access		Installer Access	
					Display	Modify	Display	Modify
ANTI-CYCLING	G	1	Anti-cycle Time (Anti Cycl Tm)	21	No	No	Yes	Yes
		2	Anti-cycle Override Differential (Override Diff)	21	No	No	Yes	Yes
		3	Minimum On/Off Delay Stages 1, 3 (On/off Delay)	21	Yes	Yes	Yes	Yes
		4	Next On Delay	21	Yes	Yes	Yes	Yes
CONTROL MODES	H	1	SH Controlling Sensor (SH Cnt Sensor)	22	No	No	Yes	Yes
		2	Enable Input (Active / Inactive)	22	No	No	Yes	Yes
		3	BMS Input (Active / Inactive)	22	No	No	Yes	Yes
		4	Cascade (Active / Inactive)	22	No	No	Yes	Yes
		5	Sequencer	22	No	No	Yes	Yes
		6	ModBus (Active / Inactive)	22	No	No	Yes	Yes
		7	ModBus Timeout (ModBus Time)	22	No	No	Yes	Yes
CASCADE	I	1	Boiler Address (Blr Adress)	23	No	No	Yes	Yes
		2	Maximum Cascade Setpoint (Max Casc Stpt)	23	Yes	Yes	Yes	Yes
		3	Cascade Offset (Cas Offset)	23	No	No	Yes	Yes
		4	Cascade Differential (Cas Different)	23	No	No	Yes	Yes
BMS	J	1	BMS Type	23	No	No	Yes	Yes
		2	Voltage at Minimum (V at Min)	23	No	No	Yes	Yes
		3	Voltage at Maximum (V at Max)	23	No	No	Yes	Yes
		4	Minimum Power (Min Power)	23	No	No	Yes	Yes
		5	Maximum Power (Max Power)	23	No	No	Yes	Yes
		6	Minimum Setpoint (Min Setpoint)	23	No	No	Yes	Yes
		7	Maximum Setpoint (Max Setpoint)	24	No	No	Yes	Yes
		8	Voltage to Start CFH (V at Start)	24	No	No	Yes	Yes
		9	Voltage Differential Stop CFH (V Diff Stop)	24	No	No	Yes	Yes
PUMPS	K	1	System Pump Delay (Sys Pump Dlay)	24	No	No	Yes	Yes
		2	SH Pump Delay (SH Pump Delay)	24	No	No	Yes	Yes
		3	DHW Pump Delay (DHW Pump Dlay)	24	No	No	Yes	Yes
		4	System Pump Mode (Sys Pump Mode)	24	No	No	Yes	Yes
SERVICE NOTIFICATION	L	1	Service Interval Time (months) (Srv Int Time)	24	No	No	Yes	Yes
		2	Service Interval Run (Srv Int Run)	24	No	No	Yes	Yes
		3	Service Interval Operation (hours) (Srv Int Op)	24	No	No	Yes	Yes
		4	Reset Service	24	No	No	Yes	Yes
		5	Accept Personality Plug (Accept PPlug)	24	No	No	Yes	Yes

# 1 Service *(continued)*

## Parameter table B - Water Heater Operation

**Table 1E** This table lists SMART SYSTEM control module parameters and where to access them for water heater operation ONLY

	Menu	Sub Item	Description	See Page	User Access		Installer Access	
					Display	Modify	Display	Modify
GENERAL	A	1	User Code	17	Yes	Yes	Yes	Yes
		2	Date and Time	17	Yes	Yes	Yes	Yes
		3	Software Version (Software Ver)	17	Yes	No	Yes	Yes
		4	Temperature Units (Temp Units)	17	Yes	Yes	Yes	Yes
		5	DHW Night Setback Offset (DHW NSB Temp)	17	Yes	Yes	Yes	Yes
		6	DHW Night Setback Times (DHW NSB Time)	17	Yes	Yes	Yes	Yes
TEMP. SETTINGS	B	1	Manual Reset High Limit (Man Res Hi Lim)	18	Yes	Yes	Yes	Yes
DATA LOGGING	C	1	Hours Running DHW (Hours Run DHW)	18	No	No	Yes	Yes
		2	Ignition Attempts (Ign Attempts)	18	No	No	Yes	Yes
		3	Last 10 Lockouts	18	No	No	Yes	Yes
FUNCTIONS	D	1	Clear Error Log (Clr Error Log)	18	No	No	Yes	Yes
		2	Service Mode Delay (Service Delay)	18	No	No	Yes	Yes
		3	Display Timeout (Display Time)	18	No	No	Yes	Yes
		4	Bypass Valve Time (Bypass V Time)	18	No	No	Yes	Yes
		5	Freeze Protection Pump On (Freeze Pump)	19	No	No	Yes	Yes
		6	Freeze Protection Burner On (Freeze Burn)	19	No	No	Yes	Yes
		7	Freeze Protection Differential (Freeze Differ)	19	No	No	Yes	Yes
DHW SETTINGS	E	1	Tank Setpoint	19	Yes	Yes	Yes	Yes
		2	DHW Tank Offset (DHW Tank Offs)	19	No	No	Yes	Yes
		3	DHW Tank Differential (DHW Tank Diff)	19	No	No	Yes	Yes
ANTI-CYCLING	F	1	Anti-cycle Time (Anti Cycl Tm)	21	No	No	Yes	Yes
		2	Anti-cycle Override Differential (Override Diff)	21	No	No	Yes	Yes
		3	On/Off Delay	21	Yes	Yes	Yes	Yes
		4	Next On Delay	21	Yes	Yes	Yes	Yes
CONTROL MODES	G	1	Enable Input (Active / Inactive)	22	No	No	Yes	Yes
		2	BMS Input (Active / Inactive)	22	No	No	Yes	Yes
		3	Cascade (Active / Inactive)	22	No	No	Yes	Yes
		4	ModBus (Active / Inactive)	22	No	No	Yes	Yes
		5	ModBus Timeout (ModBus Time)	22	No	No	Yes	Yes
CASCADE	H	1	Boiler Address (Blr Adress)	23	No	No	Yes	Yes
		2	Maximum Cascade Setpoint (Max Casc Stpt)	23	Yes	Yes	Yes	Yes

# 1 Service

## Parameter table B - Water Heater Operation *(continued)*

**Table 1E\_** *(continued from previous page)* This table lists SMART SYSTEM control module parameters and where to access them for water heater operation ONLY

	Menu	Sub Item	Description	See Page	User Access		Installer Access	
					Display	Modify	Display	Modify
BMS	I	1	BMS Type	23	No	No	Yes	Yes
		2	Voltage at Minimum (V at Min)	23	No	No	Yes	Yes
		3	Voltage at Maximum (V at Max)	23	No	No	Yes	Yes
		4	Minimum Power (Min Power)	23	No	No	Yes	Yes
		5	Maximum Power (Max Power)	23	No	No	Yes	Yes
		6	Minimum Setpoint (Min Setpoint)	23	No	No	Yes	Yes
		7	Maximum Setpoint (Max Setpoint)	24	No	No	Yes	Yes
		8	Voltage to Start CFH (V at Start)	24	No	No	Yes	Yes
		9	Voltage Differential Stop CFH (V Diff Stop)	24	No	No	Yes	Yes
PUMPS	J	1	DHW Pump Delay (DHW Pump Delay)	24	No	No	Yes	Yes
SERVICE NOTIFICATION	K	1	Service Interval Time (months) (Srv Int Time)	24	No	No	Yes	Yes
		2	Service Interval Run (Srv Int Run)	24	No	No	Yes	Yes
		3	Service Interval Operation (hours) (Srv Int Op)	24	No	No	Yes	Yes
		4	Reset Service	24	No	No	Yes	Yes
		5	Accept Personality Plug (Accept PPlug)	24	No	No	Yes	Yes



# 1 Service *(continued)*

## Viewable and changeable control parameters

### CAUTION

Before changing parameters, note the settings so that the unit can be returned to its original operating parameters.

### General

#### User code

The User Code allows the user to access and change a limited number of control parameters. The access code can be changed by the user or the installer to a code of their choosing. The default code is 0704. The code can be changed one digit at a time by using the arrow keys on the display.

#### Date and time

The control uses an internal clock for the night setback feature and for logging of events. For these features to work correctly, the clock must be set when the unit is first installed or any time the unit has been powered off for more than 30 days. The date and time are displayed as “YY:MM:DD W hh:mm”. YY = year, MM = month, DD = date, W = day (1 = Monday, 2 = Tuesday, etc.), hh = hour (24 hour time; 2:00 PM = 14:00), mm = minutes.

### NOTICE

The internal clock does not adjust for Daylight Savings Time and therefore, will require a manual adjustment.

#### Software version

The software version allows the user to view the software version in use by the control. This software controls the operation of the unit. When a new software version becomes available, the existing control can be replaced with a new control to update the software.

#### Temperature units

The control can be configured to display temperature in either °C or °F. The default is °F.

#### SH Night setback offset (boiler only)

Once the internal clock has been set correctly, the SH night setback feature can be used to program a lower setpoint. The value of this parameter will be subtracted from the normal setpoint to determine the setpoint used during night setback. The temperature range for this parameter is 0°F to 90°F (50°C). The feature is turned off with a setting of 0°F. The default value is 0°F.

#### SH Night setback times (boiler only)

If the *SH Night Setback* parameter is set to anything other than 0°F, the night setback feature becomes active. This will require start and stop times to be programmed for the days that reduced temperatures are required. Each day of the week (Monday through Sunday) will have an on and off time.

**Example:** Monday ON: 22:30, Tuesday OFF: 6:45. If you wish to skip a day and have no night setback, set the on and off times to the same time, and prior to 12:00 p.m. To keep night setback active through the entire day, set the on and off time to the same time, and after 12:00 p.m. The default times for each day will be 08:00 (OFF) and 18:00 (ON).

#### DHW Night setback offset

Once the internal clock has been set correctly, the DHW night setback feature can be used to program a lower SH setpoint during various times of the week. The value of this parameter will be subtracted from the normal setpoint to determine the setpoint used during night setback. The temperature range for this parameter is 0°F to 90°F (50°C). The default value is 0°F.

#### DHW Night setback times

If the *DHW Night Setback* parameter is set to anything other than 0°F, the DHW night setback feature becomes active. This will require start and stop times to be programmed for the days that reduced temperatures are required. Each day of the week (Monday through Sunday) will have an on and off time. If you wish to skip a day, set the on and off times to the same time, and prior to 12:00 p.m. To keep night setback active through the entire day, set the on and off times to the same time and after 12:00 p.m.

### Temperature settings

#### SH Setpoint (boiler only)

The SH setpoint user sets the water temperature setpoint for fixed operation, or the maximum temperature setpoint when the outdoor air sensor is used. The temperature range of this parameter is 60°F (15°C) to 230°F (110°C). The default value is 80°F (27°C).

#### SH Minimum setpoint (boiler only)

The SH minimum setpoint sets the minimum water temperature setpoint that can be used for space heating operation. The user or installer will not be able to program the control with a lower SH setpoint. The temperature range of this parameter is 32°F (0°C) to 230°F (110°C). The default value is 70°F (21°C).

# 1 Service

## SH Maximum setpoint (boiler only)

The SH maximum setpoint sets the maximum water temperature setpoint that can be used for space heating. The user or installer will not be able to program the control with a higher SH setpoint. The temperature range of this parameter is 32°F (0°C) to 230°F (110°C). The default value is 220°F (104°C).

## SH Offset (boiler only)

The SH offset sets how many degrees above setpoint the temperature has to go before the unit will shut off. The temperature range of this parameter is 0°F (0°C) to 54°F (30°C). The default value is 10°F (5°C).

## SH Differential (boiler only)

The SH differential sets how many degrees below the turn off temperature the temperature has to go before the unit will turn on. The temperature range of this parameter is 0°F (0°C) to 54°F (30°C). The default value is 20°F (11°C).

## Manual reset high limit

The SMART SYSTEM control includes an integrated manual reset high limit (MRHL) feature, based on the outlet temperature. The temperature range of this parameter is 32°F (0°C) to 210°F (99°C) for water heaters, or 240°F (115°C) for boilers. The default value is 210°F (99°C).

## Auto reset high limit (boiler only)

The SMART SYSTEM control also includes an integrated auto reset high limit (ARHL) feature, based on outlet temperature. The ARHL setpoint is fixed at 205°F (96°C) for water heaters. For boilers, the temperature range of this parameter is 32°F (0°C) to 235°F (113°C). The default value is 200°F (93°C).

## Data logging

### Hours running SH (boiler only)

The hours running SH parameter shows the total number of hours the unit has been in the SH firing mode.

### Hours running DHW

The hours running DHW parameter shows the total number of hours the unit has been in the DHW firing mode.

## Ignition attempts

The burner cycles parameter shows the total number of times the unit has attempted to fire.

## Last 10 lockouts

The control will log the 10 most current lockouts with the date and time the lockout occurred.

## Functions

### Clear error log

The reset last 10 lockouts parameter allows the lockout counter to be reset to 0. Once accessed, press the RESET key to clear the counter.

### Service mode delay

By pressing the PREVIOUS and NEXT keys on the front of the display for five (5) seconds, the control will be placed in Service Mode. This will override all other heat demands. The Service Mode allows the installer to set the unit to either maximum firing rate or minimum firing rate for the purpose of combustion analysis. The delay sets the length of time the unit will stay in the Service Mode if no keys have been pressed before going back to its original state. The time range of this parameter is 0 to 40 minutes. The default value is 20 minutes.

### Display timeout

Whenever a button on the display is pushed, the backlight on the LCD is turned on, and a delay timer is reset. When this timer expires, the backlight turns off, and the display returns to the first Status Screen. The range of this timer is 0 to 255 seconds. Setting this parameter to 0 disables the backlight. The default value is 60 seconds.

### Bypass valve time

In low temperature systems, a 3-way bypass valve can be installed between the outlet and the inlet of the heater (see Installation and Operation Manual). The SMART SYSTEM control can be set to automatically control this valve to maintain the inlet temperature above the condensing temperature. Different valves require different amounts of time to open and close completely. The SMART SYSTEM controls need to know how long this takes in order to control the bypass valve properly. The range of this parameter is 0 to 255 seconds. The default value is 20 seconds.

# 1 Service *(continued)*

## Freeze protection pump on

In order to prevent the water in the heater from freezing, the SMART SYSTEM control turns on the boiler pump whenever the inlet temperature goes below the minimum temperature. The range of this parameter is 32°F (0°C) to 104°F (40°C). The default value is 45°F (7°C).

## Freeze protection burner on

If the inlet temperature continues to drop after strating the pump (see *Freeze Protection Pump On*), and the inlet temperature goes below a second minimum temperature, the first stage will fire. The temperature range of this parameter is 32°F (0°C) to 104°F (40°C). The default value is 37°F (3°C).

## Freeze protection differential

Once the pump has turned on, this parameter determines how much the inlet temperature must rise before the pump turns off. Similarly, once Stage 1 has turned on, this parameter also determines how much the inlet temperature must rise before Stage 1 turns back off. The temperature range of this parameter is 0° to 72°F (40°C). The default temperature is 5°F (3°C).

## DHW settings

### DHW tank setpoint

When a temperature sensor is installed in the DHW tank, the DHW tank setpoint sets the target temperature of the water in the tank. The temperature range of this parameter is 60°F (15°C) to 190°F (88°C). The default value is 120°F (49°C).

### DHW boiler setpoint (boiler only)

When an indirect DHW call for heat becomes active, the control will use the DHW boiler setpoint to determine the firing rate of the unit based on the actual outlet water temperature. The temperature range of this parameter is 32°F (0°C) to 261°F (127°C). The default value is 180°F (82°C).

### SH/DHW switching time (boiler only)

When a SH call for heat and a DHW call for heat are present at the same time, the SMART SYSTEM control can switch back and forth between the two calls. This parameter determines the maximum length of time the boiler will service the SH call before switching to the DHW call. The range of this parameter is 0 to 240 minutes. Setting this parameter to 0 disables the switching function. The control will service the DHW demand until it ends, then return to the SH demand (if active). The default value of this parameter is 30 minutes.

### DHW/SH switching time (boiler only)

The time that the SMART SYSTEM control services a DHW demand before returning to the SH demand is set by this parameter. The range of this parameter is 0 to 240 minutes. Setting this parameter to 0 disables the switching function. The default value of this parameter is 30 minutes.

### DHW Tank offset (water heater only)

The tank offset is the number of degrees the DHW tank temperature must go above the tank setpoint before the water heater will turn off. The temperature range of this parameter is 0° to 10°F (5°C). The default value is 4°F (2°C).

### DHW Tank differential

The tank differential is the number of degrees the DHW tank temperature must go below the tank setpoint before the heater or boiler will start to heat the DHW tank. The temperature range of this parameter is 0° to 40°F (22°C). The default value is 6°F (3°C).

# 1 Service

**Figure 1-1\_ Outdoor Air Reset Curve**

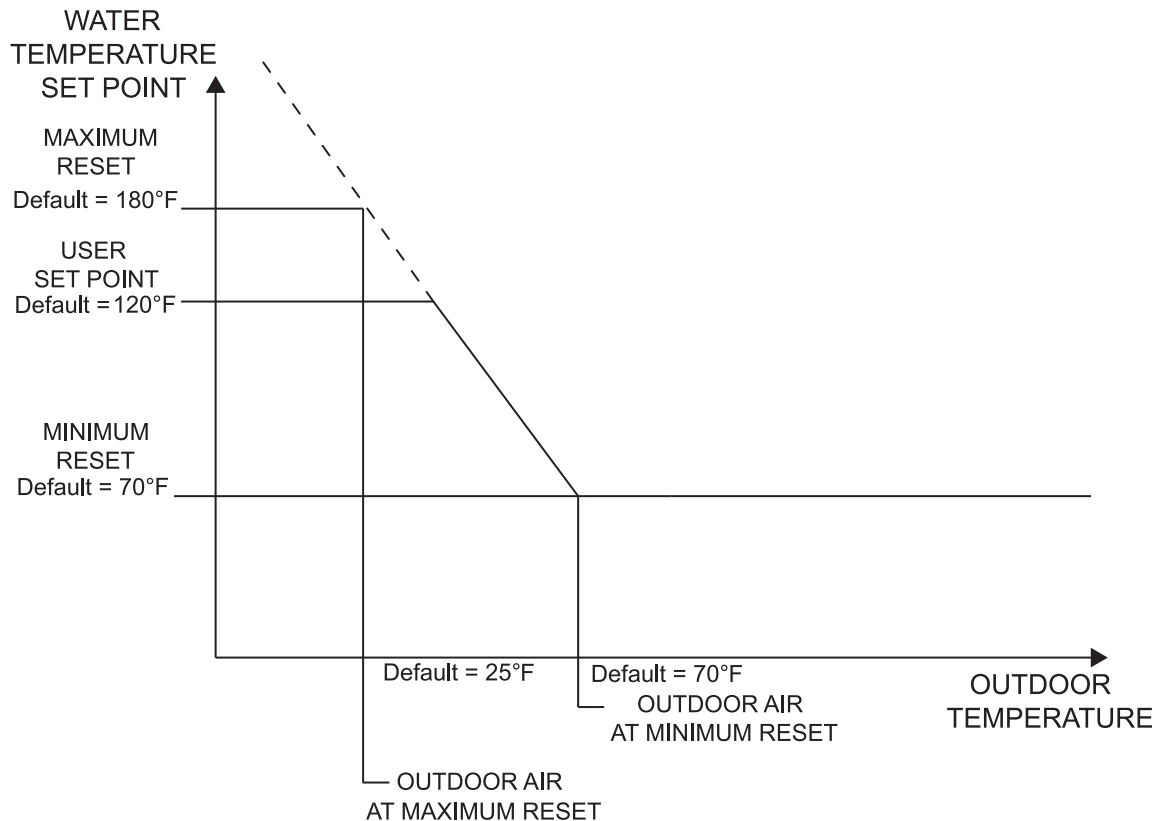

## Outdoor air reset (boiler only)

### Outdoor air reset operation

When the outdoor air sensor is installed, the control will calculate the water temperature setpoint based on the outdoor air temperature. As the outdoor air temperature drops, the water temperature setpoint increases. This feature allows the unit to be more efficient in periods of mild weather, see FIG. 1-1.

### Minimum air temperature

When the outdoor air temperature drops to this point, the water temperature will be at its maximum setting (FIG. 1-1). The setpoint will continue to increase as the outdoor temperature drops below this setting. The water temperature will be limited by the user setpoint. The temperature range of this parameter is -22°F (-30°C) to 86°F (30°C). The default value is 25°F (-4°C).

### Maximum air temperature

When the outdoor air temperature rises to or above this point, the water temperature will be at its minimum setting (FIG. 1-1). The temperature range of this parameter is -22°F (-30°C) to 86°F (30°C). The default value is 70°F (21°C).

### Maximum SH setpoint

When the outdoor temperature drops to its minimum setting (F1) the water temperature setpoint will be at this value, if the SH setpoint is set higher (FIG. 1-1). The temperature range of this parameter is 32°F (0°C) to 248°F (120°C). The default value is 180°F (82°C).

### Minimum SH setpoint

When the outdoor temperature rises to or above its maximum setting (F2) the water temperature will be at this value (FIG. 1-1). The temperature range of this parameter is 32°F (0°C) to 248°F (120°C). The default value is 70°F (21°C).

### Outdoor air shutdown

When the outdoor temperature rises above this point, the control will block all SH demands (DHW demands will still be active). The temperature range of this parameter is 32°F (0°C) to 122°F (50°C). The default value is 80°F (27°C).

# 1 Service *(continued)*

## Outdoor air shutdown differential

The outdoor air shutdown differential parameter is the number of degrees below parameter F5 the outdoor air temperature must go before the unit will respond to a SH demand. The temperature range of this parameter is 0°F (0°C) to 90°F (50°C). The default value is 10°F (5°C).

## Shift reset curve

The shift reset curve parameter shifts the actual setpoint above or below the calculated setpoint the number of degrees in this parameter. The temperature range of this parameter is -27°F (-15°C) to 27°F (15°C). The default value is 0°F (0°C). This feature will be active if this parameter is set to anything other than 0°F (0°C).

## Boost temperature

If a SH demand lasts longer than the programmed time delay setting (F9) and there have been no DHW demands, the control will increase the SH setpoint by the amount in this parameter. If the SH demand continues through another time period, the setpoint will be increased again. This will continue until either the SH demand ends, a maximum of 20 increases has occurred, or the SH user setpoint has been reached. Once the SH demand has been satisfied the setpoint will revert back to its calculated setting. The temperature range of this parameter is 0°F (0°C) to 45°F (25°C). The default value is 0°F (0°C). This feature will be active if this parameter is set to anything other than 0°F (0°C).

## Boost time

The boost time parameter sets the amount of time that must elapse with a SH demand before the water temperature setpoint will be increased. The time range for this parameter is 1 minute to 250 minutes. The default value is 20 minutes.

## Anti-cycling

### Anti-cycle time

Once a demand has been satisfied, a set amount of time must elapse before the control will respond to a new demand. The control will block the new heat demand and anti-cycling will be shown in the display until the time has elapsed or the water temperature drops below the *Anti-cycle Override Differential* parameter. The time range for this parameter is 0 minutes to 40 minutes. The default value is 1 minute.

### Anti-cycle override differential

The control will bypass the anti-cycling time if the inlet water temperature drops too quickly. The control will use the water temperature at the time it shut off as the starting point. If the temperature drops below the temperature parameter the control will abort anti-cycling and allow the unit to fire. The temperature range of this parameter is 0°F (0°C) to 54°F (30°C). The default value is 10°F (5°C).

## Minimum On/Off delay Stages 1, 3

Whenever Stage 1 or Stage 3 (if used) starts or stops, a timer is started. This timer must expire before that stage can turn off or back on. The range of this parameter is 0 to 255 seconds. The default value is 60 seconds.

## Next on delay

Whenever Stage 1 or Stage 3 (if used) turns on, a timer must expire before another Stage 1 or 3 can turn on, whether in the same heater, or in another heater in a Cascade. The range of this parameter is 0 to 255 seconds. The default value is 60 seconds.

# 1 Service

## Control modes

### SH controlling sensor (boiler only)

The SH controlling sensor parameter selects the sensor the control will use to regulate the boiler firing rate. The sensor selections are as follows: The outlet sensor regulates the firing rate based on the outlet water temperature of the unit and the inlet sensor regulates the firing rate based on the inlet water temperature of the unit. If the outlet sensor is selected, and the optional system supply sensor is connected, the control will regulate the firing rate based on the system sensor temperature. If the inlet sensor is selected, and the optional system return sensor is connected, the control will regulate the firing rate based on the system return sensor. When programmed to use the inlet sensor, a system supply sensor must be installed for proper operation. If a 3-way valve is installed for low temperature protection, a system return sensor must be installed as well. The default sensor is the Outlet Sensor.

### Enable input (active / inactive)

The boiler or water heater can receive a call for heat in two different ways. First, an external contact (like a tank aquastat) or sensor (like a tank sensor) can generate a call for heat. Second, the 0-10V voltage from a BMS can be used to generate the call for heat (as well as provide the setpoint or modulation command). These signals can come into the physical connections on the boiler, or through ModBus. If a tank sensor (or tank temperature from ModBus) is used, the tank aquastat signal is ignored. To generate the call for heat through an external contact, sensor, or temperature, the Enable input parameter must be set to Active. To generate a call for heat through the 0 - 10V BMS signal, the Enable input parameter must be set to Inactive. The BMS input parameter must be set to Active before this parameter can be set to Inactive. The default value is Active.

### BMS input (active / inactive)

The setpoint or the firing rate may be controlled by a 0 - 10V signal from a BMS. This signal can be a 0 - 10V voltage connected to the BMS input, or a 0 - 10V value sent through ModBus. To control the heater with the BMS signal, set the BMS input parameter to Active. The default value is Inactive. See Menu *Section J* on page 14, or *Section I* on page 16, to adjust the parameters that determine how the heater is controlled by the 0 - 10V signal.

### Cascade (active / inactive)

Boilers or water heaters may be part of a group of units sequenced together. When so connected, each heater must be programmed to operate as part of the Cascade. This is done by setting the Cascade to Active. The default value is Inactive.

### Sequencer (active / inactive) (boiler only)

The individual stages in the heater can be controlled separately with an external sequencer.

### ModBus (active / inactive)

When the optional ModBus board is installed, the heater can be monitored and controlled by a Building Control System (BCS). If the heater is to be controlled through ModBus this parameter must be set to ACTIVE. The default value is Inactive.

### ModBus timeout

When the heater is given information or is controlled through ModBus, this information must be refreshed periodically. This prevents the heater from running indefinitely should the ModBus communication be lost. If the information stops being refreshed, the heater automatically reverts to local signals for control. For most signals, this timeout is 4 minutes 15 seconds. If the system temperature, tank temperature, or 0 - 10V BMS signal is provided through ModBus, this timeout is set by the ModBus Timeout parameter. The range of this parameter is 0 to 255 seconds. The default value is 10 seconds.

# 1 Service *(continued)*

## Cascade

### Boiler address

The boiler designated as the Leader needs to be programmed with address 0. All the Member boilers require addresses from 1 to 7, and the addresses must be different for each Member. The addresses can be in any order, regardless of the order in which the units are wired together. The outdoor air (if used), system supply sensor, and system return sensor must be connected to the Leader boiler. The default address is 1.

### Maximum Cascade setpoint

When the system supply sensor is connected, or the system supply temperature is provided through ModBus, this parameter determines the setpoint used by the individual boilers in a Cascade. When a boiler is commanded to fire by the Leader boiler, it will attempt to achieve this temperature at its outlet. The Leader boiler will limit the modulation of the last boiler to fire in order to hold the temperature at the system supply sensor to the user setpoint. If any of the boiler outlet temperatures reach the max. cascade setpoint, the boiler will then modulate down on its own in order to keep its outlet temperature within the max. cascade setpoint. Therefore, this parameter can be used to limit the outlet temperatures of all the boilers in a Cascade. Note that this parameter does not apply when the boiler is heating an indirect DHW tank. The temperature range for this parameter is 32°F (0°C) - 261°F (127°C). The default max. cascade setpoint is 185°F (85°C).

### Cascade offset (boiler only)

This parameter determines how much the temperature must go above setpoint before the lead boiler will turn off. The temperature range for this parameter is 0°F (0°C) - 54°F (30°C). The default value is 9.9°F (5°C).

### Cascade differential (boiler only)

This parameter determines how much the temperature must go below the turn off temperature (Setpoint + Offset) before the lead boiler turns on. The temperature range for this parameter is 0°F (0°C) - 54°F (30°C). The default value is 19.8°F (11°C).

## Building Management System (BMS)

### BMS type

When the unit or cascade is controlled by the 0-10V BMS input, the voltage signal can control either the firing rate (power) or the setpoint. The default value is Power.

### Voltage at minimum

This setting determines the voltage at which the external signal begins to increase either the modulation or the setpoint. Below this voltage, the modulation or setpoint will be at their minimum values. The range for this parameter is 0V - (*Voltage at Maximum* parameter - 0.1V). The default value is 2V.

### Voltage at maximum

This setting determines the voltage at which the external signal forces either the modulation or the setpoint to their maximum value. This parameter, along with the previous parameter, determines how much the modulation or setpoint changes as the BMS input voltage changes. The modulation or setpoint will change in proportion to the change in voltage between the minimum and maximum voltage settings. The range for this parameter is (*Voltage at Minimum* parameter + 0.1V) - 10V. The default setting is 10V.

### Minimum power

This setting determines the modulation of the unit or cascade when the BMS input voltage is at or below the Voltage at Minimum setting. This parameter is active only when the BMS type is set to Power. The range for this parameter is 0 - *Maximum Power* parameter. The default value is 20%.

### Maximum power

This setting determines the modulation of the unit or cascade when the BMS input voltage is at or above the Voltage at Maximum setting. This parameter is only active when the BMS type is set to Power. The range for this parameter is *Minimum Power* parameter - 100%. The default value is 100%.

### Minimum setpoint

This setting determines the setpoint used by the unit or cascade when the BMS voltage is at or below the Voltage at Minimum setting. This parameter is only active when the BMS type is set to Setpoint. The temperature range for this parameter is 32°F (0°C) - 230°F (110°C) (boilers), or 32°F (0°C) to 190°F (87°C) (water heaters). The default value is 70°F (21°C).

# 1 Service

## Maximum setpoint

This setting determines the setpoint used by the unit or cascade when the BMS voltage is at or above the Voltage at Maximum setting. This parameter is only active when the BMS type is set to Setpoint. The temperature range for this parameter is 32°F (0°C) - 230°F (110°C) (boilers) or 32°F (0°C) to 190°F (87°C) (water heaters). The default value is 190°F (88°C) for water heaters and 220°F (104°C) for boilers.

## Voltage to start CFH

When the Enable input is set to Inactive, this parameter determines the BMS input voltage at which the unit or cascade is enabled. When the unit is disabled, the unit will become enabled when the BMS input voltage rises up to or above this value. The range for this parameter is (*Voltage Differential CFH* parameter + 0.1V) - 10V. The default value is 2V.

## Voltage differential stop CFH

When the Enable input is set to Inactive, this parameter determines the BMS input voltage at which the unit or cascade is disabled. When the unit is enabled, the unit will become disabled when the BMS input voltage drops down to or below the enable voltage minus this value. The range for this parameter is 0V - (*Voltage to Start CFH* parameter - 0.1V). The default value is 1V.

## Circulation pumps

### System pump delay (boiler only)

The system pump delay parameter sets the length of time the system pump (if connected) will run after a SH demand has been satisfied or outdoor air shutdown begins. The time range for this parameter is 1 minute to 40 minutes. The default time is 30 seconds.

### SH pump delay (boiler only)

The SH pump delay parameter sets the length of time the boiler pump will run after a SH demand has been satisfied. The time range for this parameter is 1 minute to 40 minutes. The default time is 30 seconds.

### DHW pump delay

The DHW pump delay parameter sets the length of time the DHW pump (boiler), or unit pump (water heater) will run after a DHW demand has been satisfied. The time range for this parameter is 1 minute to 40 minutes. The default time is 30 seconds.

### System pump mode (boiler only)

The system pump can be configured to operate in one of two modes. "CFH" runs the system pump whenever there is a SH demand. "WWSD" runs the system pump continuously, except when the boiler is blocked due to outdoor shutdown. The default mode is CFH.

## Service Notification

### Service interval time (months)

When the boiler control determines that a scheduled service is due based on days of installation, the boiler display will alternate the standard boiler display text with the message SERVICE DUE every 5 seconds. The time range for this parameter is 0 months to 36 months. The default time is 12 months.

### Service interval run

When the boiler control determines that a scheduled service is due based on the hours of actual operation, the boiler display will alternate the standard boiler display text with the message SERVICE DUE every 5 seconds. The time range for this parameter is 0 hours to 100,000 hours. The default time is 10,000 hours.

### Service interval operation

When the boiler control determines that a scheduled service is due based on the number of boiler cycles, the boiler display will alternate the standard boiler display text with the message SERVICE DUE every 5 seconds. The range for this parameter is 0 cycles to 100,000 cycles. The default is 10,000 cycles.

### Reset service reminder

Once servicing has been completed, the service notification counter should be reset. Once accessed, press the RESET key to reset the service notification counter.

### Accept personality plug

After replacing a control board, the new control will require the installer to verify the model in which it is installed. As soon as the power is turned on, the screen will display "Wrong ID Plg". Locate the control ID label on the front of the control panel. Note the number written on this label. Access this parameter. That number should appear after the word "Setting:" on the bottom line. If this number matches the number on the connector, press "Enter".



## 2 Maintenance

### Maintenance and annual startup

Table 2A\_Service and Maintenance Schedules

Service technician (see the following pages for instructions)		Owner maintenance (see the User's Information Manual for instructions)		
ANNUAL START-UP	<b>General:</b>		<ul style="list-style-type: none"> <li>• Check appliance area</li> <li>• Check pressure/temperature gauge</li> </ul>	
	<ul style="list-style-type: none"> <li>• Address reported problems</li> <li>• Inspect interior; clean and vacuum if necessary;</li> <li>• Check for leaks (water, gas, flue, condensate)</li> <li>• Examine venting system</li> <li>• Check system water pressure/system piping/expansion tank</li> <li>• Check control settings</li> <li>• Check igniters</li> <li>• Check wiring and connections</li> <li>• Check flue gas passageways</li> <li>• Flame inspection (stable, uniform)</li> <li>• Inspect and clean the burners</li> <li>• Check manifold gas pressures</li> <li>• Perform start-up checkout and performance verification per the Startup Section in the Installation and Operation Manual.</li> </ul>		<ul style="list-style-type: none"> <li>• Check vent piping</li> <li>• Check air piping</li> <li>• Check relief valve</li> <li>• Replace combustion air filter</li> </ul> <p><b>Note:</b> More frequent replacement may be necessary in dirty environments. Do not use pleated filters.</p>	
	<b>If combustion or performance indicate need:</b>			<ul style="list-style-type: none"> <li>• Test low water cutoff (if used)</li> <li>• Reset button (low water cutoff)</li> </ul>
	<ul style="list-style-type: none"> <li>• Clean heat exchanger with a stiff bristle brush</li> <li>• Remove and clean burners using water. Dry before re-assembling.</li> <li>• Clean the blower wheel with a brush and vacuum. Do not let dirt from cleaning get pulled into the blower.</li> </ul>			<ul style="list-style-type: none"> <li>• Check appliance piping (gas and water) for leaks</li> <li>• Operate relief valve</li> </ul>

## 2 Maintenance

**⚠ WARNING** Follow the service and maintenance procedures given throughout this manual and in component literature shipped with the appliance. Failure to perform the service and maintenance could result in damage to the appliance or system. Failure to follow the directions in this manual and component literature could result in severe personal injury, death, or substantial property damage.

**⚠ WARNING** The appliance should be inspected annually only by a qualified service technician. In addition, the maintenance and care of the appliance designated in Table 2A and explained on the following pages must be performed to assure maximum appliance efficiency and reliability. Failure to service and maintain the appliance and system could result in equipment failure.

**⚠ WARNING** Electrical shock hazard – Turn off power to the appliance before any service operation on the appliance except as noted otherwise in this instruction manual. Failure to turn off electrical power could result in electrical shock, causing severe personal injury or death.

### Address reported problems

1. Inspect any problems reported by the owner and correct before proceeding.

### Inspect appliance area

1. Verify that appliance area is free of any combustible materials, gasoline and other flammable vapors and liquids.

### Inspect appliance interior

1. Remove the outer access panels and inspect the interior of the appliance.
2. Vacuum any sediment from inside the appliance and components. Remove any obstructions.

### Check all piping for leaks

**⚠ WARNING** Eliminate all system or appliance leaks. Continual fresh makeup water will reduce appliance life. Minerals can build up in sections, reducing heat transfer, overheating heat exchanger, and causing heat exchanger failure. Leaking water may also cause severe property damage.

1. Inspect all water and gas piping and verify to be leak free.
2. Look for signs of leaking lines and correct any problems found.
3. Check gas line using the procedure found in the *Gas Connections* of the Installation and Operation Manual.

### Flue vent system and air piping

1. Check for gastight seal at every connection, seam of air piping, and vent piping periodically inspected by a qualified service agency.

**⚠ WARNING** Venting system must be sealed gastight to prevent flue gas spillage and carbon monoxide emissions, which will result in severe personal injury or death.

### Combustion air filter

This appliance has a standard air filter located at the combustion air inlet at the rear of the appliance. This filter helps ensure clean air is used for the combustion process. Check this filter every month and replace. The filter size on the 500,000 - 750,000 Btu/hr models is 12" x 12" x 1" and 16" x 16" x 1" on the 990,000 - 2,070,000 Btu/hr models. You can find these commercially available at any home center or HVAC supply store. Do not use pleated filters.

### Check water system

1. Verify all system components are correctly installed and operational.
2. Check the cold fill pressure for the system. Verify it is correct (must be a minimum of 12 PSI).
3. Watch the system pressure as the boiler heats up (during testing) to ensure pressure does not rise too high. Excessive pressure rise indicates expansion tank sizing or performance problem.
4. Inspect automatic air vents and air separators. Remove air vent caps and briefly press push valve to flush vent. Replace caps. Make sure vents do not leak. Replace any leaking vents.

### Check expansion tank (if provided)

1. Expansion tanks provide space for water to move in and out as the heating system water expands due to temperature increase or contracts as the water cools. Tanks may be open, closed, diaphragm or bladder type. See the *Water Connections Section* of the Installation and Operation Manual for suggested best location of expansion tanks and air eliminators.

## 2 Maintenance *(continued)*

### Check relief valve

1. Inspect the relief valve and lift the lever to verify flow. Before operating any relief valve, ensure that it is piped with its discharge in a safe area to avoid severe scald potential. Read the *Water Connections* Section of the Installation and Operation Manual before proceeding further.

#### **⚠ WARNING**

Safety relief valves should be re-inspected **AT LEAST ONCE EVERY THREE YEARS**, by a licensed plumbing contractor or authorized inspection agency, to ensure that the product has not been affected by corrosive water conditions and to ensure that the valve and discharge line have not been altered or tampered with illegally. Certain naturally occurring conditions may corrode the valve or its components over time, rendering the valve inoperative. Such conditions are not detectable unless the valve and its components are physically removed and inspected. This inspection must only be conducted by a plumbing contractor or authorized inspection agency – not by the owner. Failure to re-inspect the boiler relief valve as directed could result in unsafe pressure buildup, which can result in severe personal injury, death, or substantial property damage.

#### **⚠ WARNING**

Following installation, the valve lever must be operated **AT LEAST ONCE A YEAR** to ensure that waterways are clear. Certain naturally occurring mineral deposits may adhere to the valve, rendering it inoperative. When manually operating the lever, water will discharge and precautions must be taken to avoid contact with hot water and to avoid water damage. Before operating lever, check to see that a discharge line is connected to this valve directing the flow of hot water from the valve to a proper place of disposal. Otherwise severe personal injury may result. If no water flows, valve is inoperative. Shut down the appliance until a new relief valve has been installed.

2. After following the above warning directions, if the relief valve weeps or will not seat properly, replace the relief valve. Ensure that the reason for relief valve weeping is the valve and not over-pressurization of the system due to expansion tank waterlogging or undersizing.

### Inspect/replace hot surface igniter

This unit uses a proven hot surface ignition module and a hot surface igniter. The hot surface ignition module is not repairable. Any modification or repairs will invalidate the warranty.

#### **⚠ WARNING**

Do not attempt to repair a faulty hot surface igniter or ignition module. Any modification or repairs may create hazardous conditions that result in property damage, personal injury, fire, explosion and/or toxic gases.

A faulty hot surface igniter or ignition module must be replaced with an identical part. A specification igniter and ignition module for this specific unit is available from your local distributor. **Do not use general purpose field replacement ignition modules or igniters.**

### Inspect/replace hot surface igniters

1. Turn off main electrical power to the appliance.
2. Turn off main manual gas shutoff to the appliance.
3. Remove lower front door to gain access to the hot surface igniter.
4. Locate the hot surface igniter. Disconnect the two power leads to the hot surface igniter.
5. Loosen and remove the two screws used to attach the igniter.
6. Remove the igniter from the combustion chamber door. Use care, do not hit or break the silicon carbide igniter. Do not contaminate the igniter by handling with oily or dirty hands.
7. Check the replacement igniter for cracks or damage before installing.
8. Ensure that the fiber gasket used to seal the base of the igniter to the combustion chamber door is reinstalled to seal the base of the replacement igniter.
9. Carefully insert the igniter into the opening of the combustion chamber door and re-attach the two screws removed in Step 5. Over-tightening may break the ceramic mounting flange.
10. Ensure that the igniter gasket is properly installed and seals the point of contact between the igniter and the combustion chamber door.
11. Reconnect the power leads to the igniter.
12. Replace the lower front door.
13. Turn on main gas supply and main power.
14. Test fire the appliance to ensure proper operation.

## 2 Maintenance

### Check all wiring

1. Inspect all wiring, making sure wires are in good condition and securely attached.

### Check control settings

1. Set the SMART SYSTEM control module display to Parameter Mode and check all settings. See Section 1 of this manual. Adjust settings if necessary. See Section 1 of this manual for adjustment procedures.
2. Check settings of external limit controls (if any) and adjust if necessary.

### Perform start-up and checks

1. Start appliance and perform checks and tests specified in *Start-up Section* of the Installation and Operation Manual.
2. Verify cold fill pressure is correct and that operating pressure does not go too high.

### Check burner flame

Visually check main burner flames at each start-up after long shutdown periods or at least every six months. The burner viewports are located on either end of the appliance.

**⚠ WARNING** The area around the burner viewport is hot and direct contact could result in burns.

**Figure 2-1** Flame Pattern Illustration

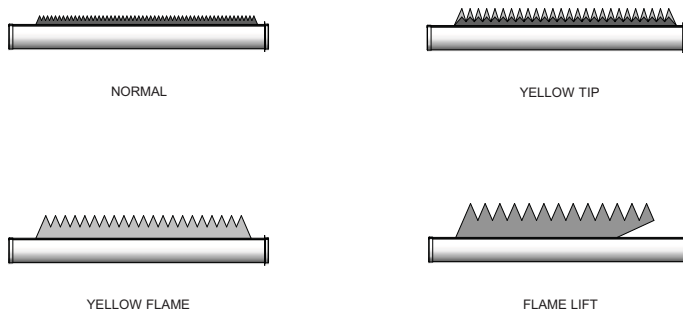

**Normal Flame:** A normal flame at 100% of burner input is blue, with slight yellow tips, a well defined flame and no flame lifting.

**Yellow Tip:** Yellow tipping can be caused by blockage or partial obstruction of air flow to the burner.

**Yellow Flames:** Yellow flames can be caused by blockage of primary air flow to the burner or excessive gas input. This condition **MUST** be corrected immediately.

**Lifting Flames:** Lifting flames can be caused by over firing the burner, excessive primary air or high draft.

If improper flame is observed, examine the venting system, ensure proper gas supply and adequate supply of combustion and ventilation air.

### Check flue gas passageways

Any sign of soot around the refractory, at the burners, or in the areas between the fins on the copper heat exchanger indicates a need for cleaning. The following cleaning procedure must only be performed by a qualified serviceman or installer. Proper service is required to maintain safe operation. Properly installed and adjusted units seldom need flue cleaning.

#### NOTICE

All gaskets/sealants on disassembled components or jacket panels must be replaced with new gaskets/sealants on reassembly. Gasket and sealant kits are available from your distributor.

#### ⚠ CAUTION

When a Category IV vent system is disconnected for any reason, the flue must be reassembled and resealed according to the vent manufacturer's instructions.

### Inspect and clean burner

The burner should be removed for inspection and cleaned on an annual basis. An appliance installed in a dust or dirt contaminated environment may require cleaning of the burner on a 3 to 6 month schedule or more often, based on severity of the contamination. The fan assisted combustion process may force airborne dust and dirt contaminants, contained in the combustion air, into the burner. With sustained operation, non-combustible contaminants may reduce burner port area, reduce burner input or cause non-warrantable damage to the burners.

Use extreme care when operating an appliance for temporary heat during new construction. Airborne contaminants such as dust, dirt, concrete dust or drywall dust can be drawn into the burner with the combustion air and block the burner port area. An external combustion air filter is provided with the appliance. This filter helps ensure clean air is used for the combustion process. Check this filter every month and replace when it becomes dirty. The burner of an appliance used for temporary heat without a combustion air filter installed will probably require a thorough cleaning before the unit is placed into normal service.

## 2 Maintenance *(continued)*

### Access to the burners will require the following steps:

1. Turn off main electrical power to the appliance.
2. Turn off main manual gas shutoff to the appliance.
3. Remove the upper and lower outer front access doors.
4. Disconnect the manifold(s) from the gas train using the union(s) just below each gas valve.
5. Disconnect the wiring to the hot surface igniter(s) and ground.
6. Disconnect burner pressure line at burner.
7. Remove the screws from the manifold mounting bracket(s) and remove the manifold(s).
8. Remove the screws from the burner mounting flanges and slide the burner(s) out toward the front of the unit. Use caution to prevent damage to the burners, refractory, hot surface igniter, and wiring.
9. Remove soot from the burners with a stiff bristle brush. Dirt may be removed from the burner ports by rinsing the burner thoroughly with water. Drain and dry burners before re-installing. Damaged burners must be replaced.
10. Reassemble in reverse order.

#### NOTICE

When installed in a dusty and dirty location, the burners may require cleaning on a 3 to 6 month schedule or as needed, based on the severity of contamination. Contaminants can be drawn in with the combustion air. Non-combustible particulate matter such as dust, dirt, concrete dust, or drywall dust can block burner ports and cause non-warrantable failure. The standard inlet air filter will help eliminate dust and dirt from entering the unit.

#### NOTICE

While burners are removed, check the heat exchanger surface for sooting. If present, the heat exchanger must be cleaned. Reference the *Heat Exchanger Cleaning* procedures in this manual.

### Checking combustion air pressure

The combustion air fans are factory pre-set and should not require adjustment in most cases. Follow the steps in the *Checking / Adjusting Combustion Air Pressure* Section to adjust the fan if a continuous Low Air status code occurs.

#### NOTICE

On the 399,999 - 750,000 Btu/hr models, the air shutter is adjusted to the side of the fan as depicted in FIG. 2-2. On the 990,000 - 2,070,000 Btu/hr models, the air shutter is adjusted by sliding the arm located on the front of the air box as depicted in FIG. 2-3.

Check for proper installation and draft in the venting system prior to any adjustments. Correct as needed.

**Figure 2-2** Adjusting air shutter - 399,999 - 750,000 Btu/hr Models

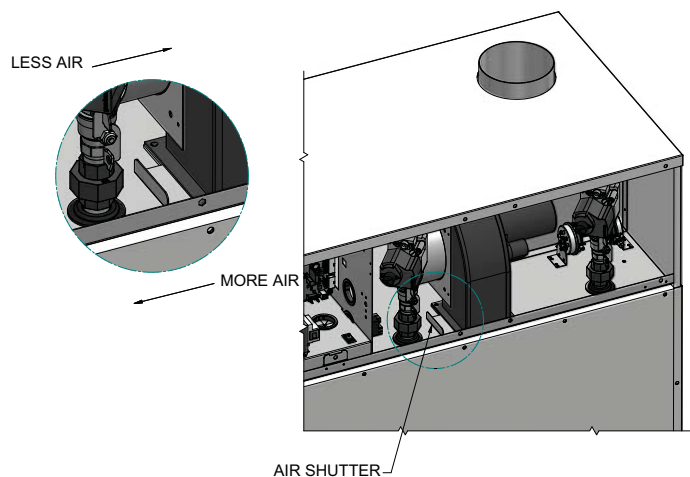

**Figure 2-3** Adjusting air shutter - 990,000 - 2,070,000 Btu/hr Models

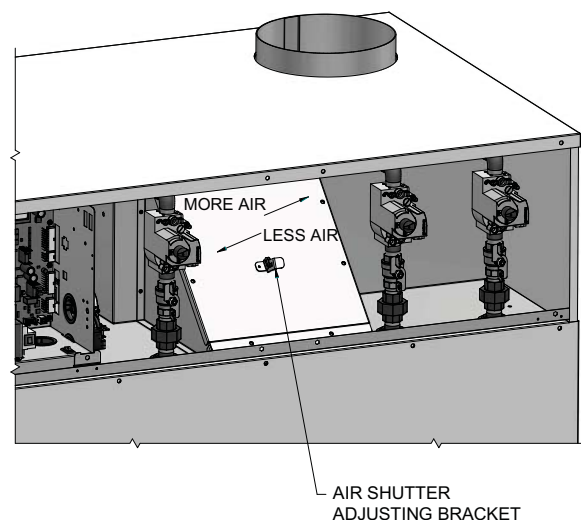

## 2 Maintenance

### Adjusting combustion air pressure

The following is a recommended method for setting the combustion air pressure. The following pressure settings are for installations up to 4000 feet altitude. Contact the factory for high altitude air pressure settings.

Upon removal of the upper front doors, locate the capped tee in the pressure tubing that connects between the inner top and the gas valves. Remove this cap and connect a hose from the tee to a manometer.

#### For 399,999 - 750,000 Btu/hr models (reference FIG. 2-2)

1. The combustion air chamber pressure for these models is typically 1.2 - 1.3 inches water column when the fan is at high speed.
2. If adjustment is necessary, slightly loosen the nuts connecting the fan to the inner top.
3. Adjust the air shutter located underneath the fan assembly to obtain the desired chamber pressure. Slide the shutter inward to decrease the chamber pressure or outward to increase the chamber pressure.

#### For 990,000 - 2,070,000 Btu/hr models (reference FIG. 2-3)

1. The combustion air chamber pressure for these models is typically 1.2 - 1.3 inches water column when the fan is at high speed.
2. If adjustment is necessary, slightly loosen the nut located on the air shutter arm.
3. Adjust the air shutter arm to obtain the desired chamber pressure. Slide the arm inward to decrease the chamber pressure or outward to increase the chamber pressure.

#### All models

4. Once the adjustment procedure is complete, tighten all connections, disconnect the manometer, and replace the cap at the tee.
5. Check all connections and test fire the unit.
6. Replace all panels.

### Checking manifold gas pressure

The gas regulator on the combination gas valve is adjustable to supply the proper manifold pressure for normal operation. The gas valves are factory pre-set and should not need adjusting in most cases. Gas manifold pressures are listed in Table 2B.

Gas manifold pressures may be checked with the use of a manometer. Follow the steps in the *Checking Combustion Air Pressure Section* prior to checking the manifold pressures.

### Checking manifold gas pressure

1. Turn the appliance power switch to the "OFF" position.
2. Remove the upper outer access panels.
3. Remove the 1/8" hex plug from the downstream side of the gas valve (see FIG. 2-4). Install a fitting in the tap and connect a hose from the tap to a manometer.
4. Connect a hose from the tee used to measure the combustion air pressure to the other side of the manometer.
5. Turn the appliance power switch to the "ON" position.
6. With the unit at high fire, check and record the manifold pressure of the valve. The manifold pressure will be the sum of the two pressure readings (reference Table 2B).
7. Repeat this process with each gas valve.

#### WARNING

Overfire and underfire hazards! Possible fire, explosion, overheating, and component failure. Do not attempt to adjust firing rate of the appliance. The firing rate must be adjusted only by factory trained personnel.

#### If you must adjust the gas valve regulator pressure, follow the steps below:

1. Remove the cap covering the manifold pressure adjustment screw (see FIG. 2-4). **Note:** Once the cap is removed, the pressure shown on the manometer will change and the unit may turn off.
2. Make a slight adjustment to the manifold pressure adjustment screw. Turning the screw clockwise increases manifold pressure and counterclockwise decreases manifold pressure.
3. Replace the cap and check the manifold pressure. **Note:** Allow the unit to re-light if necessary.
4. Repeat the steps above to match the manifold pressures from Table 2B.
5. Once the adjustment procedure is complete, turn off the appliance, disconnect the manometer, replace and tighten all connections, and replace all panels.
6. Turn on the appliance and test fire the unit.
7. Repeat this process with each gas valve.

## 2 Maintenance *(continued)*

**Figure 2-4** Measuring manifold gas pressure

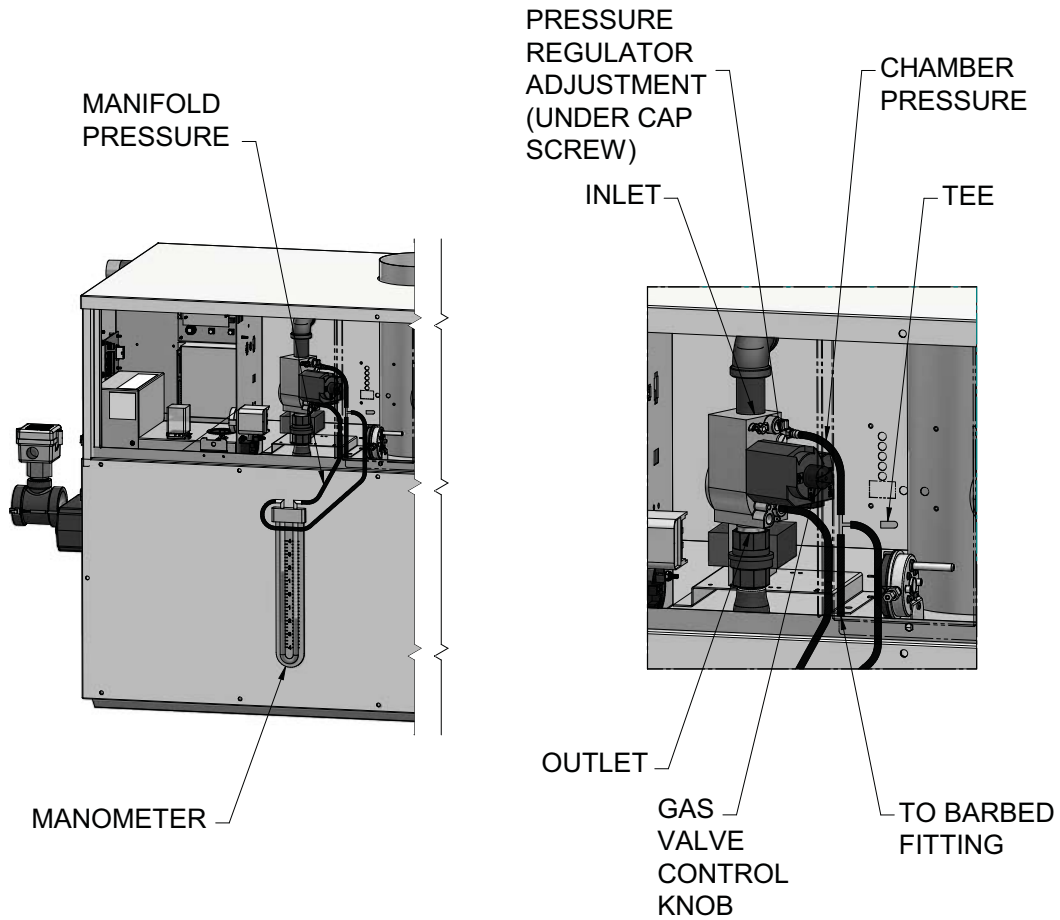

**TABLE 2B**  
 Net Manifold Pressure  
 Regulator Pressure Less  
 Front Chamber Pressure

MODEL	Nat. Gas	LP
402 - 752	1.8" w.c.	4.6" w.c.
992 - 2072	1.2" w.c.	4.6" w.c.

## 2 Maintenance

### Inspect and clean the heat exchanger

1. Turn off the main electrical power to the appliance.
2. Turn off the main manual gas shutoff to the appliance.
3. Remove the lower outer front access door.
4. Disconnect the manifold(s) from the gas train using the union(s) just below each gas valve.
5. Disconnect wiring to the hot surface igniter(s) and ground.
6. Disconnect burner pressure line at burner.
7. Remove the screws from the manifold mounting bracket(s) and remove the manifold(s).
8. Remove the screws from the burner mounting flanges and slide the burner(s) out toward the front of the unit. Use caution to prevent damage to the burners, refractory, hot surface igniter, and wiring.
9. Remove the inner jacket panel mounting screws and slide the panel assembly out toward the front of the appliance. Use caution to prevent damage to the refractory and hot surface igniter.
10. Check “V” baffles along the front and back edges of the heat exchanger (FIG. 2-5). Remove and clean if necessary.
11. Remove soot from the heat exchanger with a stiff bristle brush. Use a vacuum to remove loose soot from the surfaces and inner chamber.
12. If additional cleaning is required, the heat exchanger can be removed by disconnecting all water piping to the heat exchanger, removing the screws holding the heat exchanger to the inner left side panel, and sliding the heat exchanger towards the front of the appliance. Once the heat exchanger is removed from the appliance, a garden hose can be used to wash the tubes to ensure that all soot is removed from the heat exchanger surfaces.

#### NOTICE

Do not wet the refractory located on the inside of the combustion chamber.

13. Ensure that all burner ports are cleaned to remove any soot (reference this section).
14. Carefully reinstall the heat exchanger, “V” baffles, and frame runners if removed from the appliance.

#### NOTICE

Make sure the frame runners seal securely where they contact the front and rear compartment refractory.

15. Carefully reinstall inner jacket panels, burners, manifolds, wires and hoses. Use new gasket material to ensure a proper air seal.
16. Reassemble all gas and water piping. Test for gas leaks.
17. Reassemble outer jacket panels.
18. Cycle the appliance and check for proper operation.

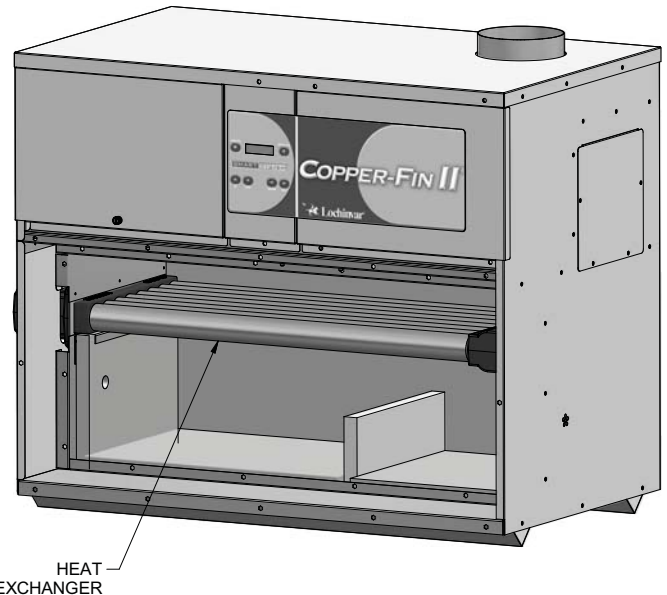

**Figure 2-5** Location of the Heat Exchanger Inside Jacket

### Review with owner

1. Review the User's Information Manual with the owner.
2. Emphasize the need to perform the maintenance schedule specified in the User's Information Manual (and in this manual as well).
3. Remind the owner of the need to call a licensed contractor should the appliance or system exhibit any unusual behavior.
4. Remind the owner to follow the proper shutdown procedure and to schedule an annual start-up at the beginning of the next heating season.

### Oiled bearing circulators

Inspect the pump every six (6) months and oil as necessary. Use SAE 30 non-detergent oil or lubricant specified by the pump manufacturer.



## 3 Troubleshooting

**⚠ WARNING** Label all wires prior to disconnection when servicing controls. Wiring errors can cause improper and dangerous operation. Always disconnect power to the appliance before servicing. Failure to comply could result in severe personal injury, death, or substantial property damage.

**⚠ WARNING** Never jumper (bypass) any device except for momentary testing as outlined in the Troubleshooting chart. Severe personal injury, death, or substantial property damage can result.

### Before troubleshooting:

- Have the following items:
  - Voltmeter that can check 120 VAC, 24 VAC, and 12 VDC.
  - Continuity checker.
  - Contact thermometer.
- Check for 120 VAC (minimum 102 VAC to maximum 132 VAC) to appliance.
- Make sure thermostat is calling for heat and contacts (including appropriate zone controls) are closed. Check for 24 VAC between thermostat wire nuts and ground.
- Make sure all external limit controls are installed and operating.

### Check the following:

- Wire connectors to control module are securely plugged in at the module and originating control.
- Gas pressures:

Refer to the Gas Connections Section of the Installation and Operation Manual for detailed information concerning the gas supply.

### Check control module fuses

**NOTICE** ALWAYS check control module fuses before replacing control module or any major components (blower, etc.). If one of these fuses is blown, it can prevent the control module or other components from operating.

- Turn OFF the power to the appliance at the external line switch.
- Remove front access cover.
- Inspect fuses F2, F4, F5, and F6, see FIG. 3-1 below.

**Figure 3-1**\_Control Module Fuses

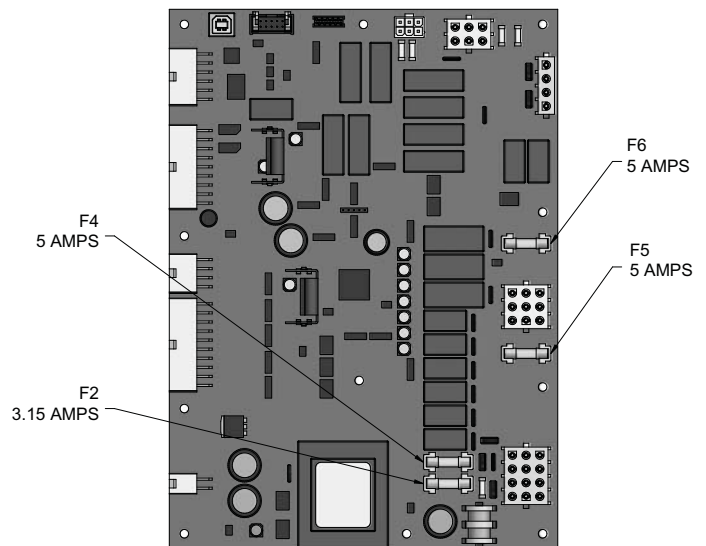

- The appliance is shipped with four (4) spare fuses in a plastic bag attached to the control panel.
- If necessary, replace open fuse (F2 is 3.15 amps and F4, F5, and F6 are 5 amps).

**Note:** Fuses F2 - F6 are all slow blow fuses.

**⚠ WARNING** Do not jumper fuse or replace with any fuse except as specified. Failure to comply could result in severe personal injury, death, or substantial property damage.

- Install front access cover after fuse inspection.
- Restore power to the appliance at the external line switch and verify boiler/water heater operation (*Start-up Section* in the Installation and Operation Manual) after completing boiler/water heater service.

### 3 Troubleshooting

**Table 3A** Troubleshooting Chart - No Display

FAULT	CAUSE	CORRECTIVE ACTION
No Display	- No 120 VAC supplied to unit.	<ul style="list-style-type: none"> <li>• Check external line switch, fuse, or breaker.</li> <li>• Check position of ON/OFF switch. Turn switch to the ON position.</li> <li>• Check 120 VAC through the ON/OFF switch. No voltage through switch, replace switch.</li> </ul>
	- Bad wiring connection.	<ul style="list-style-type: none"> <li>• Check wiring harness connection between the display board and the main control board. Connect the harness at both points.</li> </ul>
	- Blown fuse.	<ul style="list-style-type: none"> <li>• Replace fuse F6 on the main control board, see FIG. 3-1 on page 33 of this manual.</li> </ul>
	- Bad display board.	<ul style="list-style-type: none"> <li>• Replace board.</li> </ul>
	- Bad main control board.	<ul style="list-style-type: none"> <li>• Replace main control board.</li> </ul>
No Burner Operation	- Main control board temperature setpoint satisfied.	<ul style="list-style-type: none"> <li>• Review temperature setting.</li> </ul>
	- Remote thermostat satisfied.	<ul style="list-style-type: none"> <li>• Review remote thermostat setting.</li> </ul>
	- Outside air temperature above Warm Weather Shutdown (WWSD) setpoint for main control board.	<ul style="list-style-type: none"> <li>• Check location of outside air sensor. Check resistance of outdoor air sensor and compare to Table 3C on page 35 of this manual.</li> </ul>
	- Unit locked out on fault.	<ul style="list-style-type: none"> <li>• Consult display for specific fault. Refer to fault descriptions on pages 37 - 43 of this manual for corrective actions.</li> </ul>
Unit Does Not Stage to 100%	- Boiler controlled by BMS.	<ul style="list-style-type: none"> <li>• Check BMS parameter settings. Optional PC software required.</li> </ul>
	- Outlet temperature too high.	
	- Delta T too high.	

### 3 Troubleshooting *(continued)*

#### Checking temperature sensors

The appliance temperature sensors (inlet water, outlet water, system water, tank water, flue, and outdoor air) are all resistance type devices. The following tables show the correct values for the sensors at various temperatures. Use an ohmmeter to read the resistance of the sensor at a known temperature. If the resistance of the sensor does not closely match its corresponding table, replace the sensor.

**Table 3B** Inlet/Outlet/System/Tank Sensor Resistance vs. Temperature

S1a Inlet/Outlet/System/Tank (Wire Color - R and W)				S1b Outlet Only (Wire Color - Bk and G)			
Temperature	Resistance	Temperature	Resistance	Temperature	Resistance	Temperature	Resistance
50	19,553	158	2,004	50	40,030	158	3,478
68	12,690	176	1,464	68	25,030	176	2,492
86	8,406	194	1,084	86	16,090	194	1,816
104	5,715	212	816	104	10,610	212	1,344
122	3,958			122	7,166		
140	2,786			140	4,943		

**Table 3C** Outdoor Air Sensor Resistance vs. Temperature

Temperature	Resistance	Temperature	Resistance
-50	490,813	20	46,218
-40	336,606	30	34,558
-30	234,196	40	26,099
-20	165,180	50	19,900
-10	118,018	60	15,311
0	85,362	70	11,883
10	62,465	80	9,299

### 3 Troubleshooting

**Table 3D** Troubleshooting Chart - Noisy System

FAULT	CAUSE	CORRECTIVE ACTION
Noisy Operation	- Gas supply problem.	• Refer to the <i>Gas Connections Section</i> of the Installation and Operation Manual for detailed information concerning the gas supply.
	- Gas/air mixture problem.	• Refer to the <i>Checking Manifold Gas Pressure and Combustion Analysis Procedure</i> on pages 29 and 30 of this manual for the proper settings. Verify that the vent/air intake lengths do not exceed the maximum listed in the <i>Venting</i> section of the Installation and Operation Manual.
	- Dirty/damaged burner(s).	• Refer to pages 28 and 29 in this manual for the burner removal and inspection procedure. Clean or replace the burner as necessary.
	- Low water flow through the heat exchanger.	• Refer to the <i>Water Connections Section</i> of the Installation and Operation Manual for minimum flow rates. Verify that the appliance is piped in a primary/secondary fashion and that the appliance and system pump are running on a call for heat.
	- Air in the piping system.	• Properly purge all air from the piping system.
	- Low system water pressure.	• Verify system pressure is a minimum of 12 PSI.
No Pump Operation - Boiler Pump System Pump or DHW Pump	- Faulty pump relay.	• Replace relay.
	- Faulty pump.	• Replace pump.
	- Internal fault on control board.	• Check fuse F5. • Replace main control board. <b>Note:</b> Make sure the boiler pump horse power (hp) does not exceed 1 hp.
Relief Valve Opening	- System pressure exceeds relief valve setting.	• Lower the system pressure below the rating of the supplied relief valve or replace the standard relief valve with a higher rated valve up to the maximum pressure of the heat exchanger.
	- Improperly sized expansion tank.	• Install properly sized expansion tank.
	- Outlet water temperature in excess of 210°.	• Check setpoint of temperature control. • Check temperature rise across heat exchanger. Refer to the temperature rise chart in the <i>Water Connections Section</i> of the Installation and Operation Manual.

### 3 Troubleshooting *(continued)*

**Table 3E** Troubleshooting Chart - Fault Messages Displayed on Operator Interface

FAULT	DESCRIPTION	CORRECTIVE ACTION
Gas Pressure SW (Will require a manual reset once the condition has been corrected.)	<ul style="list-style-type: none"> <li>- Either the optional manual reset low gas pressure switch or the optional manual reset high gas pressure switch tripped.</li> <li>- Models 992 - 2072 (natural gas) - Automatic Reset Low Gas is open.</li> </ul>	<ul style="list-style-type: none"> <li>• Reset the pressure switches.</li> <li>• Measure the supply gas pressure to determine cause of failure. Refer to the <i>Gas Connections Section</i> of the Installation and Operation Manual for detailed information concerning the gas supply.</li> <li>• Correct the supply gas pressure if necessary.</li> </ul>
Flow Switch/ LWCO (Lockout will reset automatically after 5 minutes or may be reset immediately once condition has been corrected. Press the RESET button on the SMART SYSTEM display to reset.)	Either the flow switch or the optional low water cutoff is not making.	<ul style="list-style-type: none"> <li>• Check pump operation on a call for heat.</li> <li>• Check for closed valves or obstructions in the water piping.</li> <li>• Verify system is full of water and all air has been purged from the system.</li> </ul>
Flame Sequence (Will require a manual reset once the condition has been corrected. Press the RESET button on the SMART SYSTEM display to reset.)	The flame detector circuit is seeing a flame signal while the gas valve is de-energized.	<ul style="list-style-type: none"> <li>• Check supply voltage for proper polarity.</li> <li>• Check that the gas valve is closed.</li> <li>• Check external wiring for voltage feedback.</li> <li>• Check the internal wiring for bad connections.</li> <li>• Replace main control board.</li> </ul>
Anti-cycling	The main control board has received a call for heat too quickly after the previous call for heat has ended.	<ul style="list-style-type: none"> <li>• The control board will release the call for heat after a set time period.</li> <li>• The control board will release the call for heat if the outlet temperature drops too quickly.</li> </ul>

### 3 Troubleshooting

**Table 3E** (continued from previous page) *Troubleshooting Chart - Fault Messages Displayed on Operator Interface*

FAULT	DESCRIPTION	CORRECTIVE ACTION
<p>No Flame Ign (Will require a manual reset. Press the RESET button on the SMART SYSTEM display to reset.)</p>	<p>The unit has failed to prove burner flame upon ignition.</p>	<ul style="list-style-type: none"> <li>• Inspect igniter and associated wiring for damage and connection. Reference page 27 of this manual for removal and cleaning procedure. Replace if necessary.</li> <li>• Check for proper electrical grounding of unit.</li> <li>• Check incoming supply gas pressure. Refer to the <i>Gas Connections Section</i> in the Installation and Operation Manual for detailed information concerning the gas supply.</li> <li>• Verify that the tube from the gas valve to the combustion air chamber is connected and is not damaged.</li> <li>• Verify that the vent/air intake pipes are correctly installed and that there are no obstructions.</li> <li>• Inspect the burners. Reference pages 28 and 29 of this manual for removal and cleaning procedures. Replace if necessary.</li> <li>• Refer to the <i>Checking Manifold Gas Pressure and Combustion Analysis Procedure</i> on pages 29 and 30 of this manual for the proper settings.</li> <li>• Check for 24 VAC to the gas valve during the ignition attempt. If no voltage is present, check the wiring between the gas valve and the main control board.</li> <li>• Replace the wiring or the main control board as necessary.</li> </ul>
<p>HSI Current Low (Will require a manual reset once the condition has been corrected. Press the RESET button on the SMART SYSTEM display to reset.)</p>	<p>Amp draw of the hot surface igniter did not meet the minimum requirement of 2.6 amps.</p>	<ul style="list-style-type: none"> <li>• Measure the amp draw of the hot surface igniter during the trial for ignition stage. If less than 2.6 amps replace the hot surface igniter.</li> <li>• If more than 2.6 amps replace the control module.</li> </ul>
<p>Flame CKT Error</p>	<p>The main control board has detected an internal fault.</p>	<ul style="list-style-type: none"> <li>• Replace the main control board.</li> </ul>

### 3 Troubleshooting *(continued)*

**Table 3E** (continued from previous page) Troubleshooting Chart - Fault Messages Displayed on Operator Interface

FAULT	DESCRIPTION	CORRECTIVE ACTION
<p>No Flame Running (Will require a manual reset once the condition has been corrected. Press the RESET button on the SMART SYSTEM display to reset.)</p>	<p>The unit was running and lost the flame signal.</p>	<ul style="list-style-type: none"> <li>• Inspect igniter and associated wiring for damage and connection. Reference page 27 of this manual for removal and cleaning procedure. Replace if necessary.</li> <li>• Check for proper electrical grounding of unit.</li> <li>• Check incoming supply gas pressure. Refer to the <i>Gas Connections Section</i> of the Installation and Operation Manual for detailed information concerning the gas supply.</li> <li>• Verify that the tube from the gas valve to the combustion air chamber is connected and is not damaged.</li> <li>• Verify that the vent/air intake pipes are installed correctly and there are no obstructions.</li> <li>• Refer to the <i>Checking Manifold Gas Pressure and Combustion Analysis Procedure</i> on pages 29 and 30 of this manual for the proper settings.</li> <li>• Inspect the burners. Reference pages 28 and 29 of this manual for removal and cleaning procedures. Replace if necessary.</li> <li>• Replace the main control board.</li> </ul>
<p>Auto Reset High Limit</p>	<p>The outlet water temperature has exceeded the setting of the automatic reset high limit.</p>	<ul style="list-style-type: none"> <li>• Verify that the system is full of water and that all air has been properly purged from the system.</li> <li>• Verify that the appliance is piped properly into the heating system. Refer to the <i>Water Connections Section</i> of the Installation and Operation Manual for the proper piping methods for the Copper-fin.</li> <li>• Check 120 VAC to boiler pump motor on a call for heat. If voltage is not present, check wiring back to the main control board. Replace the main control board if necessary.</li> <li>• If 120 VAC is present on a call for heat and the pump is not operating, replace the pump.</li> <li>• If the system pump is a variable speed pump, ensure that the system flow is not less than the boiler flow.</li> <li>• Check temperature setting of the main control board.</li> <li>• Check resistance of water sensors and compare to Table 3B on page 35 of this manual. Replace sensor if necessary.</li> <li>• Replace outlet sensor.</li> </ul>

### 3 Troubleshooting

**Table 3E** (continued from previous page) Troubleshooting Chart - Fault Messages Displayed on Operator Interface

FAULT	DESCRIPTION	CORRECTIVE ACTION
<p>Manual Reset High Limit (Will require a manual reset once condition has been corrected. Press the RESET button on the SMART SYSTEM display to reset.)</p>	<p>The outlet water temperature has exceeded the setting of the adjustable high limit.</p>	<ul style="list-style-type: none"> <li>• Verify setting of adjustable high limit.</li> <li>• Verify that the system is full of water and that all air has been properly purged from the system.</li> <li>• Verify that the appliance is piped properly into the system. <i>Refer to the Water Connections Section of the Installation and Operation Manual for proper piping methods for the Copper-fin.</i></li> <li>• Check 120 VAC to the pump motor on a call for heat. If voltage is not present, check wiring leading to the main control board. Replace the main control board if necessary.</li> <li>• If 120 VAC is present on a call for heat and the pump is not operating, replace the pump.</li> <li>• If the system pump is a variable speed pump, ensure the system flow is not less than the boiler flow.</li> <li>• Check temperature setting of the main control board.</li> <li>• Check resistance of water sensors and compare to the tables on page 35 of this manual. Replace the sensor if necessary.</li> <li>• Replace outlet sensor or high limit.</li> </ul>
<p>Inlet Low</p>	<p>The inlet water temperature did not exceed 130° within 15 minutes of ignition.</p>	<ul style="list-style-type: none"> <li>• Raise temperature setpoint above 130°.</li> <li>• Install a 3-way valve or LTV valve per the piping diagram in the <i>Water Connections Section</i> of the Installation and Operation Manual.</li> <li>• Replace the inlet sensor.</li> <li>• Replace the main control board.</li> </ul>
<p>Sensor Open (Will require a manual reset once the condition has been corrected. Press the RESET button on the SMART SYSTEM display to reset.)</p>	<p>Either the inlet water, outlet water, system supply, system return, or outdoor temperature sensor has been disconnected.</p>	<ul style="list-style-type: none"> <li>• Check the sensors and their associated wiring. Repair or replace the sensor or wiring if damaged.</li> <li>• Measure the resistance of the sensors and compare the resistance to the tables on page 35 of this manual.</li> <li>• Replace the sensor if necessary.</li> </ul>
<p>Sensor Shorted (Will require a manual reset once the condition has been corrected. Press the RESET button on the SMART SYSTEM display to reset.)</p>	<p>Either the inlet water, outlet water, system supply, system return, or outdoor temperature sensor has been shorted.</p>	<ul style="list-style-type: none"> <li>• Check the sensors and their associated wiring. Repair or replace the sensor or wiring if damaged.</li> <li>• Measure the resistance of the sensors and compare the resistance to the tables on page 35 of this manual.</li> <li>• Replace the sensor if necessary.</li> </ul>



### 3 Troubleshooting *(continued)*

**Table 3E** (continued from previous page) Troubleshooting Chart - Fault Messages Displayed on Operator Interface

FAULT	DESCRIPTION	CORRECTIVE ACTION
<p>Louver Proving (Lockout will reset automatically after 5 minutes or may be reset immediately once condition has been corrected. Press the RESET button on the SMART SYSTEM display to reset.)</p>	<p>An optional remote proving switch is not making.</p>	<ul style="list-style-type: none"> <li>• Check function of remote devices.</li> <li>• Check for loose or misplaced jumper if proving switch is not installed.</li> </ul>
<p>Tank Open</p>	<p>Sensors equipped with an internal limit (such as the Lochinvar Squire® Indirect Tank), the limit has opened due to temperature (195°F) or the sensor has become disconnected.</p>	<ul style="list-style-type: none"> <li>• Check the tank temperature.</li> <li>• Repair or replace the sensor wiring if damaged.</li> <li>• Replace the sensor if necessary.</li> </ul>
<p>APS Open (Lockout will reset automatically after 5 minutes or may be reset immediately once condition has been corrected. Press the RESET button on the SMART SYSTEM display to reset.)</p>	<p>The air pressure switch did not make within 1 minute after the combustion air blower has been energized.</p>	<ul style="list-style-type: none"> <li>• Check air filter. Clean or replace as necessary.</li> <li>• Vent/air intake lengths exceed the maximum allowed lengths.</li> <li>• Check for blockage or obstruction in vent/air inlet pipe or at terminations.</li> <li>• Verify combustion air blower is operating. Replace if necessary.</li> </ul>
<p>APS Closed (Lockout will reset automatically after 5 minutes or may be reset immediately once condition has been corrected. Press the RESET button on the SMART SYSTEM display to reset.)</p>	<p>The SMART SYSTEM control sensed that the air pressure switch was closed before the combustion air blower was energized.</p>	<ul style="list-style-type: none"> <li>• Check for jumper on air pressure switch.</li> <li>• Check for an unusually high negative draft in the vent stack.</li> </ul>
<p>Wrong ID Plug</p>	<p>Control module ID plug does not match the <i>Accept Personality Plug</i> parameter.</p>	<ul style="list-style-type: none"> <li>• Verify that ID plug is connected properly to connector X5 on the control module.</li> <li>• Verify that the wiring in the ID plug is not cut or damaged and that the wiring connectors are seated properly in the plug.</li> <li>• Verify that the number on the ID label on the control panel matches the number in the <i>Accept Personality Plug</i> parameter. If not, replace the control module.</li> <li>• When replacing control modules, verify that the number in the <i>Accept Personality Plug</i> parameter matches the number on the ID label (reference page 24 of this manual). If so, press the ENTER button on the SMART SYSTEM display. If not, replace the control module.</li> </ul>

### 3 Troubleshooting

**Table 3E** (continued from previous page) Troubleshooting Chart - Fault Messages Displayed on Operator Interface

FAULT	DESCRIPTION	CORRECTIVE ACTION
Temp O/Shoot (Lockout will reset automatically after 5 minutes or may be reset immediately once condition has been corrected. Press the RESET button on the SMART SYSTEM display to reset.)	The temperature rise across the heat exchanger has exceeded the set parameters for the appliance.	<ul style="list-style-type: none"> <li>• Verify that the system is full of water and that all air has been properly purged from the system.</li> <li>• Verify that the appliance is piped properly into the heating system. Refer to the <i>Water Connections Section</i> of the Installation and Operation Manual for the proper piping methods.</li> <li>• Check for 120 VAC to the pump motor on a call for heat. If voltage is not present, check the wiring leading to the main control board. Replace the main control board if necessary.</li> <li>• If 120 VAC is present on a call for heat and the pump is not operating, replace the pump.</li> </ul>
	Outlet water temperature has exceeded the maximum outlet water temperature.	<ul style="list-style-type: none"> <li>• Verify that the system is full of water and that all air has been properly purged from the system.</li> <li>• Verify that the appliance is piped properly into the system. Refer to the <i>Water Connections Section</i> of the Installation and Operation Manual for the proper piping methods.</li> <li>• Check 120 VAC to the pump motor on a call for heat. If voltage is not present, check wiring leading to the main control board. Replace the main control board if necessary.</li> <li>• If 120 VAC is present on a call for heat and the pump is not operating, replace pump.</li> <li>• Replace the main control board.</li> </ul>
Rem Ctrl Flt	External control is cycling too often.	<ul style="list-style-type: none"> <li>• Check setpoint of the external control.</li> <li>• Check the wiring between the external control and the unit.</li> <li>• Replace the control.</li> </ul>
Parameters Progr (Will require a manual reset once the condition has been corrected. Press the RESET button on the SMART SYSTEM display to reset.)	After downloading parameters from a laptop, the main control board must be reset.	<ul style="list-style-type: none"> <li>• Press the ENTER/RESET button on the Smart System display panel.</li> </ul>

### 3 Troubleshooting *(continued)*

**Table 3E** (continued from previous page) Troubleshooting Chart - Fault Messages Displayed on Operator Interface

FAULT	DESCRIPTION	CORRECTIVE ACTION
Service BIK	While the unit is in Service Mode, the outlet temperature has exceeded 185°F (85°C).	<ul style="list-style-type: none"> <li>Establish a heating load to remove heat from the system.</li> <li>Verify that the system is full of water and that all air has been properly purged from the system.</li> <li>Verify that the appliance is piped properly into the system. Refer to the <i>Water Connections Section</i> of the Installation and Operation Manual for the proper piping methods.</li> <li>Check 120 VAC to the pump motor on a call for heat. If voltage is not present, check the wiring leading to the main control board. Replace the main control board if necessary.</li> <li>If 120 VAC is present on a call for heat and the pump is not operating, replace the pump.</li> </ul>
Low Voltage	120 VAC input to the main control board has dropped below 100 VAC.	<ul style="list-style-type: none"> <li>Check 120 VAC supply to the transformer.</li> <li>Check wiring connections at the low voltage terminal strip.</li> <li>Check the wire size/length to remote devices.</li> <li>Replace the main control board.</li> </ul>
Watch Dog Error	The main control board has detected an internal fault.	<ul style="list-style-type: none"> <li>Cycle main power.</li> <li>Replace the main control board.</li> </ul>
Write EEPROM	The main control board has detected an internal fault.	<ul style="list-style-type: none"> <li>Cycle main power.</li> <li>Replace the main control board.</li> </ul>
Program EEPROM	The main control board has detected an internal fault.	<ul style="list-style-type: none"> <li>Cycle main power.</li> <li>Replace the main control board.</li> </ul>
CRC Parameters	The main control board has detected an internal fault.	<ul style="list-style-type: none"> <li>Cycle main power.</li> <li>Replace the main control board.</li> <li>Restore default parameters using the PC program.</li> </ul>
No Error Stored	The main control board has detected an internal fault.	<ul style="list-style-type: none"> <li>Press RESET.</li> <li>Cycle main power.</li> <li>Replace the main control board.</li> </ul>

**Revision Notes:** Revision A (ECO #C11226) initial release to reflect the new manual name and removal of the pool heater information.

Revision B (ECO C11706) reflects the update of information with the "SH Controlling Sensor (boiler only)" section on page 22.

Revision C (ECO C13992) reflects edits made to the descriptions on page 22.

CFX-CHX-SER Rev C

11/13