



INSTRUCTIONS

-J02983

REV. 2015-03-26

HEATED HAND GRIP KITS

GENERAL

Kit Numbers

56047-03C, 56107-03B, 56174-03C, 56196-03C, 56512-02C, 56619-03B, 56694-04A, 56750-04B, 56822-03A, 56825-03A, 56828-03B, 56923-05, 56926-05A, 56997-07A, 56100030, 56100111

Models

For model fitment information, see the P&A retail catalog or the Parts and Accessories section of www.harley-davidson.com (English only).

NOTE

Each kit contains one pair of heated hand grips plus the connecting parts (see Figure 22 and Table 1).

These Heated Hand Grip Kits are not compatible with internally wired handlebars.

Additional Parts Required

2011-later Softtail models, 2012-later Dyna models and 2014-later Sportster models require separate purchase of an Electrical Connection Harness (H-D Part No. 72673-11).

Tools and Supplies Required

An UltraTorch UT-100 (HD-39969), Robinair Heat Gun (HD-25070) with Heatshrink Attachment (HD-41183), or other suitable radiant heating device is required for the proper installation of this kit.

Installation of this kit requires the use of a terminal crimping tool, and other parts and supplies. Electrical Contact Lube (H-D Part No. 99861-02) or equivalent is required after battery cable disconnection. These items are available from a Harley-Davidson dealer.

⚠ WARNING

The rider's safety depends upon the correct installation of this kit. Use the appropriate service manual procedures. If the procedure is not within your capabilities or you do not have the correct tools, have a Harley-Davidson dealer perform the installation. Improper installation of this kit could result in death or serious injury. (00333a)

NOTE

This instruction sheet refers to service manual information. A service manual for this year/model motorcycle is required for this installation and is available from a Harley-Davidson dealer.

Electrical Overload

NOTICE

It is possible to overload your vehicle's charging system by adding too many electrical accessories. If the combined electrical accessories operating at any one time consume more electrical current than the vehicle's charging system can produce, the electrical consumption can discharge the battery and cause damage to the vehicle's electrical system. See an authorized Harley-Davidson dealer for advice about the amount of current consumed by additional electrical accessories or for necessary wiring changes. (00211c)

⚠ WARNING

When installing any electrical accessory, be certain not to exceed the maximum amperage rating of the fuse or circuit breaker protecting the affected circuit being modified. Exceeding the maximum amperage can lead to electrical failures, which could result in death or serious injury. (00310a)

This heated hand grip kit requires up to **2.8 A** additional current from the electrical system.

Service Parts

See Figure 22 and Table 1.

REMOVAL

Preparation

NOTE

For vehicles equipped with security siren:

- Verify that the hands-free fob is present.
- Turn ignition switch ON.

For VRSC models only: Remove the air box aluminum cover per service manual instructions.

Refer to the service manual to remove the main fuse.

For EFI models EXCEPT VRSC:

WARNING

To prevent spray of fuel, purge system of high-pressure fuel before supply line is disconnected. Gasoline is extremely flammable and highly explosive, which could result in death or serious injury. (00275a)

Follow service manual to purge and disconnect fuel supply line.

For vehicles with main fuse:

WARNING

To prevent accidental vehicle start-up, which could cause death or serious injury, remove main fuse before proceeding. (00251b)

1. Refer to the service manual to remove the main fuse.
Remove and retain the seat and all mounting hardware.

For vehicles with main circuit breaker:

WARNING

To prevent accidental vehicle start-up, which could cause death or serious injury, disconnect negative (-) battery cable before proceeding. (00048a)

1. Refer to the service manual to remove the seat and disconnect the negative (black) battery cable from the negative battery terminal. Retain all seat mounting hardware.

For carbureted models:

WARNING

Gasoline can drain from the carburetor fuel line when disconnected from fuel valve fitting. Gasoline is extremely flammable and highly explosive, which could result in death or serious injury. Wipe up spilled fuel immediately and dispose of rags in a suitable manner. (00256a)

2. Turn the fuel supply valve to OFF. Remove the fuel line from the valve.

For ALL models EXCEPT VRSC:

WARNING

When servicing the fuel system, do not smoke or allow open flame or sparks in the vicinity. Gasoline is extremely flammable and highly explosive, which could result in death or serious injury. (00330a)

3. Refer to the service manual to remove the instrument console (if equipped) from the fuel tank.
4. See the correct section (Carbureted or EFI Engine) of the service manual for fuel tank removal instructions.
5. **For FLHR models or for 1996 and later FL Softail models with Chrome Headlight Nacelle Kit (H-D Part No. 67907-96):** Refer to the service manual to remove the handlebar shroud.

Current Hand Grip Removal

For ALL Models:

1. Refer to the service manual to remove the right side handlebar switch housing assembly. This is necessary to access the throttle cables.
2. Refer to the service manual to disconnect the throttle cables and remove the current right grip/throttle sleeve assembly. After removal, make sure that the handlebar end is clean and smooth.
3. Loosen but do not remove the two screws with flat washers securing the left side handlebar clamp to the clutch lever bracket.
4. Remove upper and lower switch housing screws.
5. Remove the left side handlebar grip. If the grip is the glued-on type, carefully cut it away from the handlebar using a sharp blade or knife.
6. If equipped with a handlebar cover, riser cover or outer fairing, refer to the service manual and remove if necessary to access the wire path through the upper fork clamp.

HEATED HAND GRIP INSTALLATION

1. See Figure 22 and Table 1. Determine if the wire harness extension (7) is required for this installation:
 - Hold the right side heated hand grip/throttle sleeve and wire harness in position along the outside of the handlebar as if the assembly were installed on the handlebar. The connector at the end of the wire harness on the hand grip/sleeve must extend past the left end of the handlebar.
 - If the connector **extends** past the opposite end of the handlebar, the extension can be discarded.
 - If the connector **does not extend** past the opposite end of the handlebar, connect the extension to the end of the right side hand grip wire harness.

NOTE

Air pressure or an electrician's fish tape can be used to thread the wire harness completely through the handlebar.

If using a fish tape, hook the end of the fish tape to the connector and tape securely.

2. Remove any wire retaining clips fastening the handlebar switch harness to the handlebar.
3. Thread the connector and wire from the heated hand grip/throttle sleeve into the right side of the handlebar, all the way through and out the left side of the handlebar.
4. Install the heated hand grip/throttle sleeve, throttle cables and switch housing onto the right side of the handlebar per service manual procedures.
5. Remove the black ring from the inboard end of the left side heated hand grip (1). Insert the connector from the right side hand grip into the left side grip connector.
6. Use a strip of masking tape or grease pencil to mark the handlebar 4-3/4 in (120 mm) from the left end.

WARNING

Do not lubricate left handlebar grip before installation. Lubricating grip can cause it to come off while riding, which could result in loss of control and death or serious injury. (00315a)

NOTES

Thoroughly clean handlebar to remove all residual adhesive.

If the handlebar grips are patterned, align the pattern on the left grip with the pattern on the right grip while the throttle is in the fully closed position.

7. If a large amount of wiring from the left side hand grip extends from the left end of the handlebar, use a blunt, flexible object (such as a narrow rubber hose) in one hand to gently feed the wire into the handlebar, while using your other hand to ease the grip into position near the end of the handlebar.
8. Remove the flexible object from inside the handlebar and carefully slide the left side grip onto the handlebar, taking care not to crush, pinch or otherwise damage the wiring inside the handlebar. Push the grip onto the handlebar up to the marking from Step 6.

9. See Figure 1. Position the left side grip on the handlebar so the retaining flange (1) can be securely installed into the lower switch housing (2).

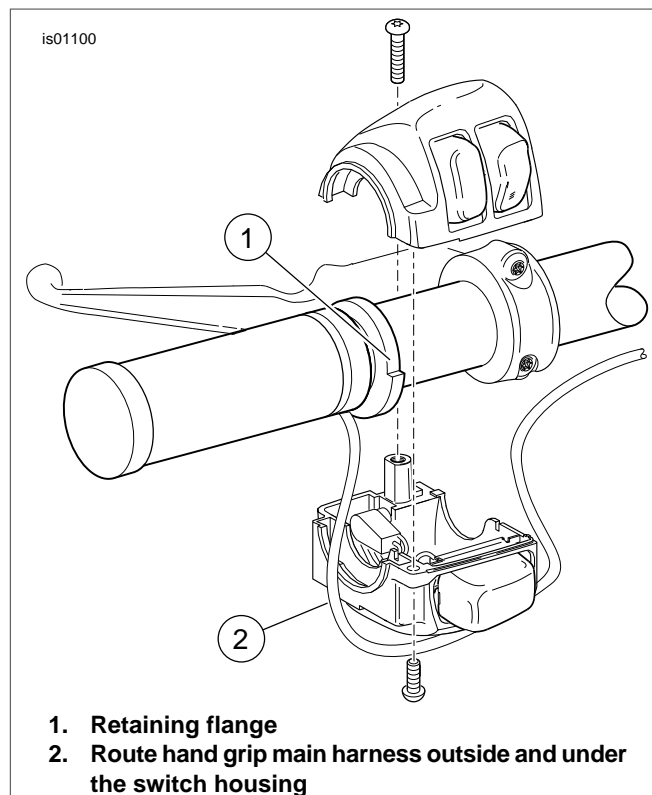

Figure 1. Heated Hand Grip (Left Side)

NOTICE

Do not route the handgrip main harness inside the switch housing. Wires routed inside the switch housing could result in short circuits and equipment damage. (00369a)

10. Route the heated hand grip main wire harness **beneath** the switch housing (2).
 11. See Figure 22. **If there are holes** on the left underside of the handlebar, install wire retainer clips (11) from the kit in the holes. Fasten the wire harness to the clips.
If no holes, use cable straps (8) to fasten the wire harness to the handlebar.
 12. Fasten the switch housing to the hand grip and handlebar per service manual instructions.
 13. Follow the existing wiring to route the heated hand grip main wire harness:
 - a. through, across or around the upper fork clamp,
 - b. along the motorcycle frame, to a general location under the seat.
- For 2006 and later VRSC models only:** Route the black wire near the battery negative terminal.
- For all VRSC models:** Route the red wire near the battery positive terminal.
14. See Figure 22. Use cable straps (8) from the kit to fasten the heated hand grip wiring to the wire harnesses along the vehicle frame.

HARNES CONNECTION - GENERAL

Splicing of wire leads is necessary in the installation of the heated hand grips to the motorcycle. Find the instructions for a specific model in the sections that follow. Refer to the service manual appendix for proper wire splicing procedures.

WARNING

Be sure to follow manufacturer's instructions when using the UltraTorch UT-100 or any other radiant heating device. Failure to follow manufacturer's instructions can cause a fire, which could result in death or serious injury. (00335a)

- Avoid directing heat toward any fuel system component. Extreme heat can cause fuel ignition/explosion resulting in death or serious injury.
- Avoid directing heat toward any electrical system component other than the connectors on which heat shrink work is being performed.
- Always keep hands away from tool tip area and heat shrink attachment.

For 2011 and later Softail models: See the next section.

For ALL OTHER models: Proceed to **BLACK LEAD CONNECTION** for the specific model.

HARNES CONNECTION: 2011-LATER SOFTAIL MODELS, 2012-LATER DYNA MODELS AND 2014-LATER SPORTSTER MODELS

NOTE

Requires separate purchase of an Electrical Connection Harness (H-D Part No. 72673-11).

1. Locate the Digital Technician connector [91A] (a gray six-way Deutsch pin connector with a rubber boot) under the seat. Place the Electrical Connection Harness at connector [91A], but **DO NOT** connect at this time.
2. Route the heated hand grip wires over to the Electrical Connection Harness. **DO NOT** cut off the in-line fuse holder on the red wire, but cut the wires to a suitable length to easily reach the sealed splice connectors on the Electrical Connection Harness.
3. Splice the black hand grip wire to the **black** wires in the Electrical Connection Harness.
4. Splice the orange/white hand grip wire to the **red/yellow** wires in the Electrical Connection Harness.
5. Splice the red hand grip wire to the **red/blue** wires in the Electrical Connection Harness.
6. Use a heat gun or suitable radiant-heating device to shrink the connector to the wires.
7. Pull the rubber boot out from the gray Digital Technician pin connector [91A]. Cut the boot off of the wires.
8. Connect the socket housing of the Electrical Connection Harness to connector [91A].
9. Insert the rubber boot into the open pin connector of the Electrical Connection Harness.
10. Loosen or remove the four screws holding the ECM to the mounting bracket. Route the Electrical Connection Harness

under the ECM connector. Tighten the four screws to 45-55 **in-lbs** (5.1-6.2 Nm).

11. Proceed to the **RETURN TO SERVICE** section.

BLACK LEAD CONNECTION TO GROUND

2011-Earlier Dyna Models

1. Remove the nut from the ground screw, on the top of the frame, under the seat near the fuel tank.
2. Select the correct ring terminal (4, 5 or 6) from the kit to fit the ground screw.
3. See Figure 2. Cut the black wire on the heated hand grip wire harness to easily reach the ground location, and crimp the ring terminal to the end of the wire per the Packard crimping tool instructions in the service manual appendix.
4. Install the ring terminal to the ground connection. Secure per the torque specification in the service manual.
5. Proceed to **For ALL models** in this section.

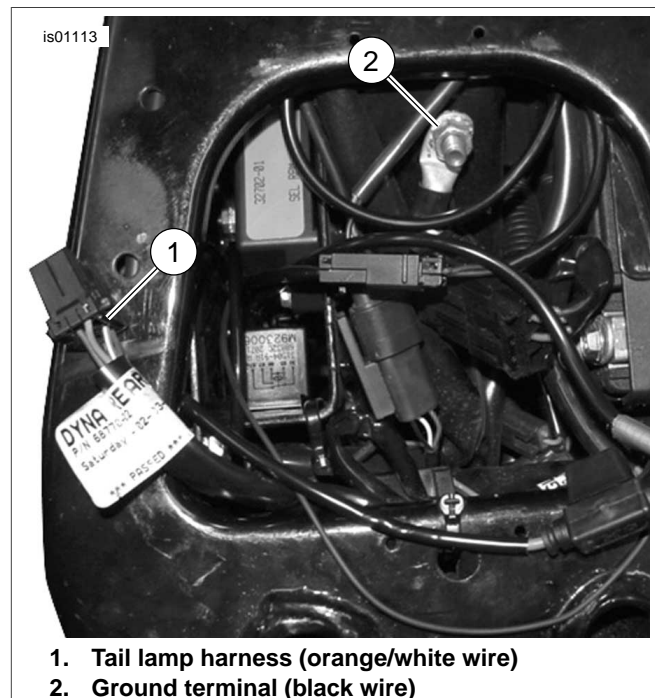

1. Tail lamp harness (orange/white wire)
2. Ground terminal (black wire)

Figure 2. Power and Ground Connections (Dyna Models)

2010-Earlier Softail Models

1. Remove the ground screw on the top of the frame, under the seat near the fuel tank.
2. Select the correct ring terminal (4, 5 or 6) from the kit to fit the ground screw.
3. Cut the black wire on the heated hand grip wire harness to easily reach the ground location, and crimp the ring terminal to the end of the wire per the Packard crimping tool instructions in the service manual appendix.
4. See Figure 3. Install the ring terminal onto the ground screw threads. Fasten the ground screw to the frame (2). Secure per the torque specification in the service manual.
5. Proceed to **For ALL models** in this section.

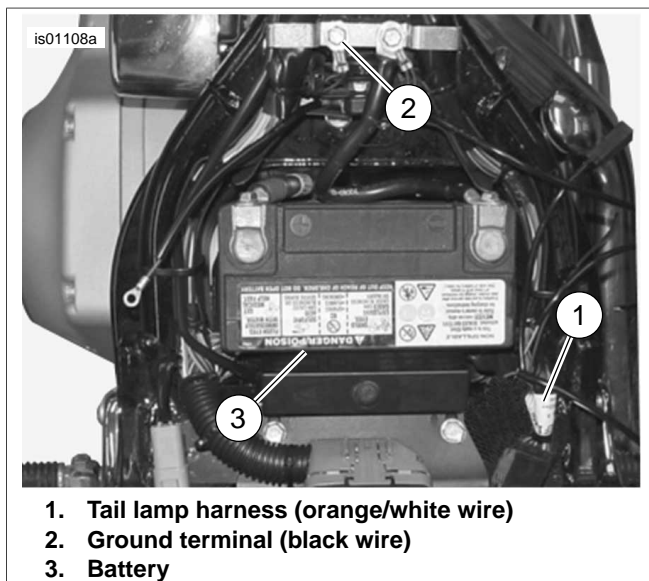

Figure 3. Power and Ground Connections (Softtail Models)

2013-Earlier Sportster Models

1. Remove the electrical side cover on the left side near the battery.
2. Route the heated hand grip wire harness through the top of the frame under the seat to the circuit breaker on the inside of the electrical side cover.
3. See Figure 4. Remove the ground screw (1), located:
 - under the seat on some 1996-2003 models, or
 - near the swingarm on 1995 or earlier models, and 1996-2003 models without a screw under the seat.
 - on the engine near the starter on 2004 and later models.
4. Select the correct ring terminal (4, 5 or 6) from the kit to fit the ground screw.
5. Cut the black wire on the heated hand grip wire harness to easily reach the ground location, and crimp the ring terminal to the end of the wire per the Packard crimping tool instructions in the service manual appendix.
6. Install the ring terminal onto the ground screw threads. Fasten the ground screw at the original location, and secure per the torque specification in the service manual.
7. Proceed to **For ALL models** in this section.

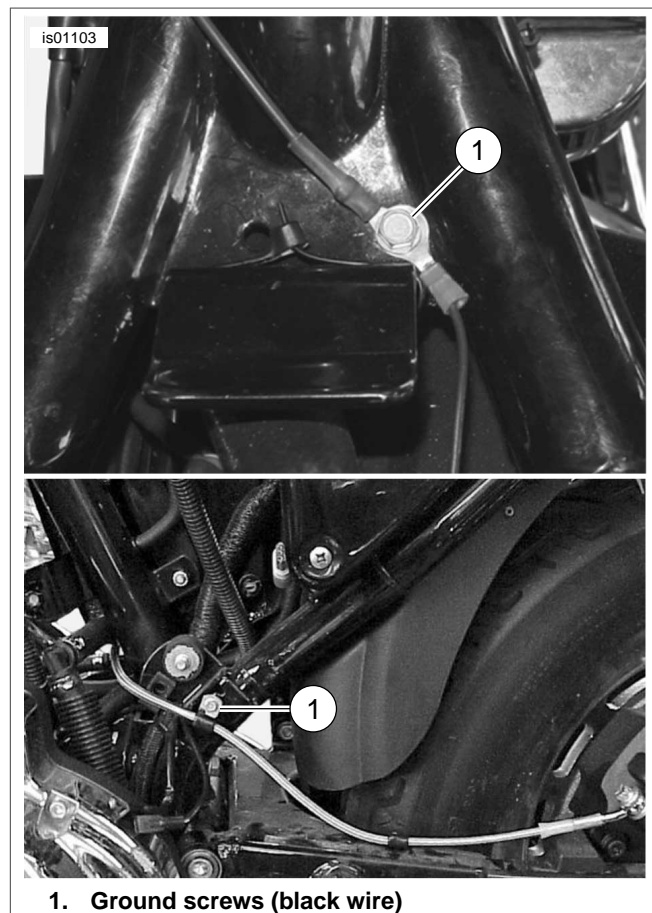

Figure 4. Ground Connections (Sportster Models)

2003-Earlier Touring Models

⚠ WARNING

Disconnect negative (-) battery cable first. If positive (+) cable should contact ground with negative (-) cable connected, the resulting sparks can cause a battery explosion, which could result in death or serious injury. (00049a)

1. **If the negative battery cable WAS NOT disconnected** at the beginning of the installation, refer to the service manual to remove the seat and disconnect the negative (black) battery cable from the negative battery terminal. Retain all seat mounting hardware.
2. Refer to the service manual to disconnect the positive battery cable. Remove the battery.

NOTE

The black wire must remain long enough so the battery fits into the battery well without stressing or stretching the wire.

3. See Figure 5. Cut the black wire on the heated hand grip wire harness to easily reach the ground stud (2) located below the circuit breaker in the battery well under the seat.
4. Select the correct ring terminal (4, 5 or 6) from the kit to fit the ground stud.

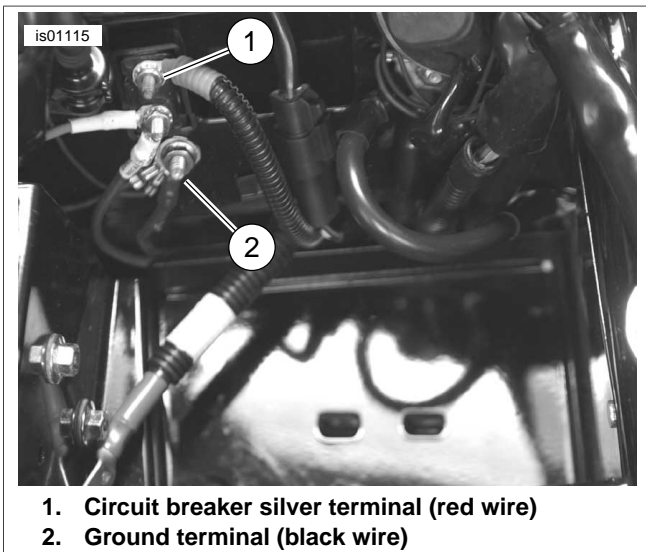

Figure 5. Connections (with battery removed) - 2003 or Earlier Touring Models (2003 FLHTCU shown)

5. Crimp the ring terminal to the end of the wire per the Packard crimping tool instructions in the service manual appendix.
6. Install the ring terminal to the ground stud. Secure per the torque specification in the service manual.
7. Proceed to **For ALL models** in this section.

2004-2007 Touring Models

1. Locate the main harness chassis ground stud (there are two, under the seat in front of the battery).
2. Remove the nut from one of the chassis ground studs.
3. Select the correct ring terminal (4, 5 or 6) from the kit to fit the ground stud.
4. Cut the black wire on the heated hand grip wire harness to easily reach the ground location. Crimp the ring terminal to the end of the wire per the Packard crimping tool instructions in the service manual appendix.
5. Install the ring terminal to the ground connection. Secure per the torque specification in the service manual.
6. Proceed to **For ALL models** in this section.

2006-Earlier V-Rod Models

1. See Figure 6. Remove the screw (1, under the seat) that fastens the ignition switch (2) to the right side of the frame.
2. Scrape the paint from the top of the frame where the screw was removed, to make a strong ground contact.
3. Select the correct ring terminal (4, 5 or 6) from the kit to fit the ignition switch screw.

4. Cut the black wire on the heated hand grip wire harness to easily reach the ground location. Crimp the ring terminal to the end of the wire per the Packard crimping tool instructions in the service manual appendix.
5. Install the black wire ring terminal onto the threads of the ignition switch screw. Install the screw to the ignition switch. Tighten to 53-88 **in-lbs** (6-10 Nm).
6. Proceed to **For ALL models** in this section.

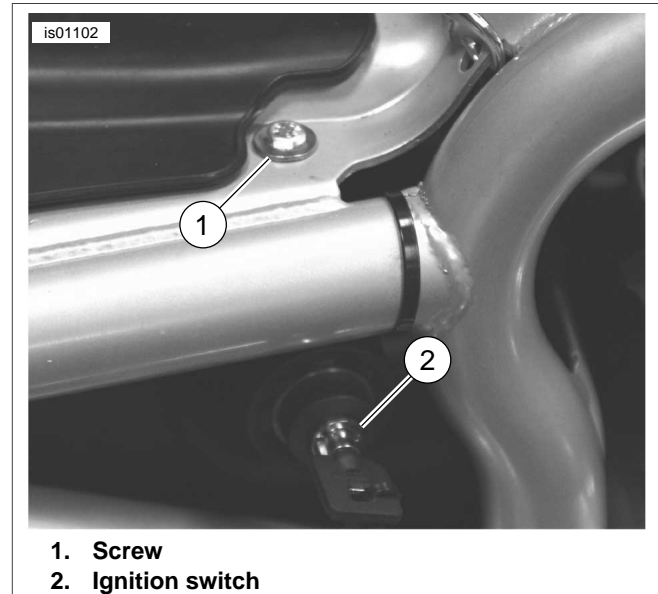

Figure 6. Ground Connection (2006 and Earlier V-Rod Models)

2007-Later V-Rod Models

The heated hand grip harness **black** wire connects directly to the battery negative terminal.

1. Select the correct ring terminal (4, 5 or 6) from the kit to fit the negative terminal fastener on the battery.
2. Cut the heated hand grip harness black wire to within easy reach of the battery negative terminal.
Crimp the ring terminal to the end of the black wire per the Packard crimping tool instructions in the service manual appendix.
3. Fasten the black wire ring terminal to the negative terminal mounting post on the battery. Tighten the terminal fastener to 60-96 **in-lbs** (7-10 Nm).

For ALL models

Verify that there is sufficient slack in the black lead so that handlebar movement will not be restricted.

Proceed to the **ORANGE/WHITE LEAD CONNECTION** section for the specific model.

ORANGE/WHITE LEAD CONNECTION TO SWITCHED POWER SOURCE

Use the service manual wiring diagrams for a specific model and year vehicle to locate a power source that is fed through the ignition switch.

2003-Earlier Dyna Models

The heated hand grip **switched** power source is an orange/white (O/W) main harness power lead inside the electrical side cover.

1. Remove the electrical side cover on the left side, near the battery.
2. See Figure 2. Carefully slice open an area of the main harness wrap inside the side cover at an accessible point, and cut an orange/white main harness power lead.
3. Cut the excess length from the orange/white power lead **of the heated hand grip wire harness** to within easy reach of the cut orange/white wires inside the side cover.
4. See Figure 22. Obtain a sealed splice connector (3) from the kit.

See Figure 7, the two into one splice configuration. Splice the heated hand grip wire harness power lead, to the main harness orange/white wires per the instructions in the service manual appendix.

5. Proceed to **For ALL models** in this section.

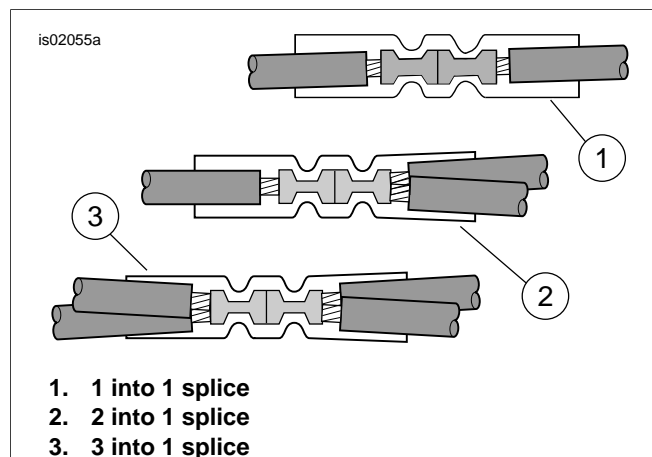

Figure 7. Splice Configurations

2004-2011 Dyna Models

The heated hand grip **switched** power source is an open fuse position on the fuse panel. See the FUSES section of the service manual and the correct wiring diagram in the service manual appendix.

1. Remove the electrical side cover on the left side near the battery, by firmly grasping both sides and pulling outward.
2. Remove the electrical panel from the vehicle per service manual instructions.
3. See Figure 22. Obtain the orange/white fuse block adapter wire (9) from the kit. Note the terminal on each end (see Figure 8). Only the terminal with the spring tabs will fit into this fuse block. Carefully cut the unused terminal from the wire and discard it.

4. See Figure 9. Locate the fuse cavity (1) indicated as "OPEN" on the fuse block cover in the right fuse block. There should be a wire feeding one side of this circuit, but no mating wire or fuse will be present.

Insert the terminal on the orange/white adapter wire until it stops. Refer to a nearby factory installed terminal for comparison to verify proper orientation and depth.

5. Cut the excess length from the orange/white power lead **of the heated hand grip wire harness** to within easy reach of the adapter wire.
6. See Figure 22. Obtain a sealed splice connector (3) from the kit.
See Figure 7, the one into one splice configuration. Splice the heated hand grip wire harness power lead, to the adapter wire per the instructions in the service manual appendix.
7. See Figure 22. Install the 2A fuse (12) from the kit into the "OPEN" fuse cavity to complete the circuit.
8. Install the electrical panel per the instructions in the service manual. Install the electrical panel cover by aligning the pins with the rubber bushings in the electrical panel and pushing firmly into place.
9. Proceed to **For ALL models** in this section.

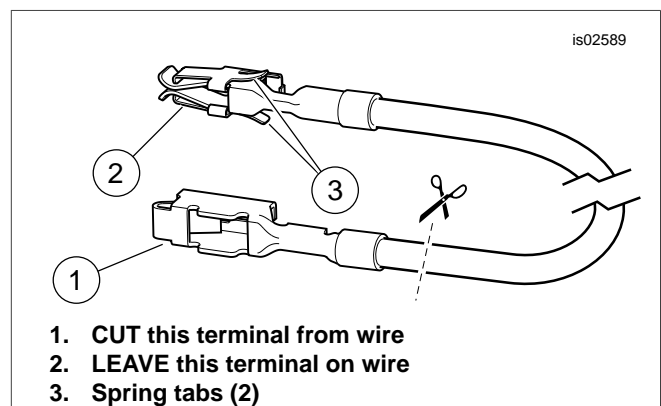

Figure 8. Fuse Block Adapter Wire (Dyna and Softail)

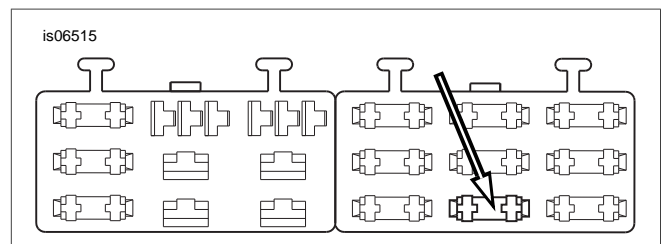

Figure 9. "OPEN" Fuse Block Cavity (2004 and Later Dyna)

2003-Earlier Softail Models

The heated hand grip **switched** power source is the orange/white (O/W) wire in the tail lamp harness under the seat.

1. See Figure 3. Carefully slice open an area of the tail lamp harness (1) wrap at an accessible point under the seat, and cut the orange/white wire.

- Cut the excess length from the orange/white power lead **of the heated hand grip wire harness** to within easy reach of the cut orange/white wires under the seat.
- See Figure 22. Obtain a sealed splice connector (3) from the kit.
See Figure 7, the two into one splice configuration. Splice the heated hand grip wire harness power lead, to the cut orange/white wires per the instructions in the service manual appendix.
- Proceed to **For ALL models** in this section.

2004-2010 Softail Models

The heated hand grip **switched** power source is an open fuse position on the fuse panel. See the FUSES section of the service manual and the correct wiring diagram in the service manual appendix.

- Remove the fuse block cover. Remove the two hex head screws fastening the fuse block bracket. Pull the bracket and fuse block assembly away from the vehicle frame.
- Press the tab retaining the left fuse block, and slide the block out of the mounting slots.
- See Figure 22. Obtain the orange/white fuse block adapter wire (9) from the kit. Note the terminal on each end (see Figure 8). Only the terminal with the spring tabs will fit into this fuse block. Carefully cut the unused terminal from the wire and discard it.
- See Figure 10. Locate the fuse cavity (1) indicated as "P&A IGN" on the fuse block cover in the right fuse block. There should be a wire feeding one side of this circuit, but no mating wire or fuse will be present.

Insert the terminal on the orange/white adapter wire until it stops. Refer to a nearby factory installed terminal for comparison to verify proper orientation and depth.

- Cut the excess length from the orange/white power lead **of the heated hand grip wire harness** to within easy reach of the adapter wire.
- See Figure 22. Obtain a sealed splice connector (3) from the kit.
See Figure 7, the one into one splice configuration. Splice the heated hand grip wire harness power lead, to the adapter wire per the instructions in the service manual appendix.
- See Figure 22. Install the 2A fuse (12) from the kit into the "P&A IGN" fuse cavity to complete the circuit.

- Slide the fuse block into the mounting slots in the fuse block bracket until it clicks firmly into place. Install the bracket and fuse block assembly into position and fasten with the two hex head screws removed earlier. Tighten securely.
- Proceed to **For ALL models** in this section.

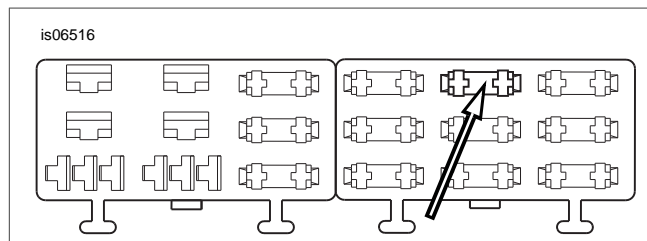
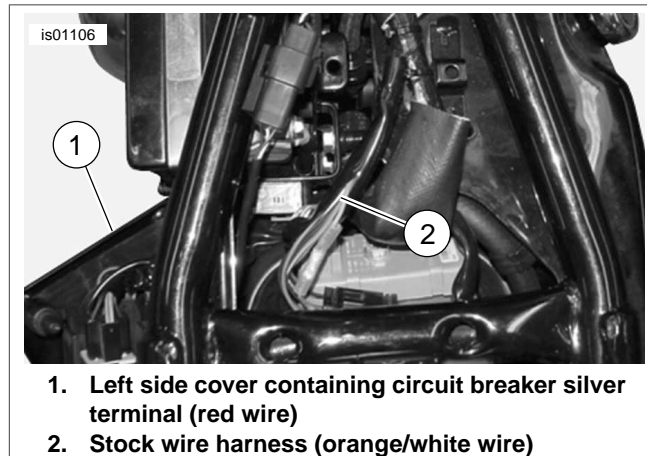

Figure 10. "P&A IGN" Fuse Block Cavity (2004-2010 Softail)

2013-Earlier Sportster Models

The heated hand grip **switched** power source is an orange/white (O/W) main harness power lead inside the electrical side cover or under the seat.

- See Figure 11. Carefully slice open an area of the main harness wrap inside the electrical side cover or under the seat at an accessible point, and cut an orange/white main harness power lead.
- Cut the excess length from the orange/white power lead **of the heated hand grip wire harness** to within easy reach of the cut orange/white wires inside the side cover or under the seat.
- See Figure 22. Obtain a sealed splice connector (3) from the kit.
See Figure 7, the two into one splice configuration. Splice the heated hand grip wire harness power lead, to the main harness orange/white wires per the instructions in the service manual appendix.
- Proceed to **For ALL models** in this section.



- Left side cover containing circuit breaker silver terminal (red wire)
- Stock wire harness (orange/white wire)

Figure 11. Power Connections (XL Models)

2003-Earlier Touring Models

The heated hand grip **switched** power source is an orange/white (O/W) main harness power lead inside the right side cover, near the top.

- See Figure 12. Carefully slice open an area of the main harness wrap inside the electrical side cover at an accessible point, and cut an orange/white main harness power lead.
- Cut the excess length from the orange/white power lead **of the heated hand grip wire harness** to within easy reach of the cut orange/white wires inside the side cover.

- See Figure 22. Obtain a sealed splice connector (3) from the kit.

See Figure 7, the two into one splice configuration. Splice the heated hand grip wire harness power lead, to the main harness orange/white wires per the instructions in the service manual appendix.

- Proceed to **For ALL models** in this section.

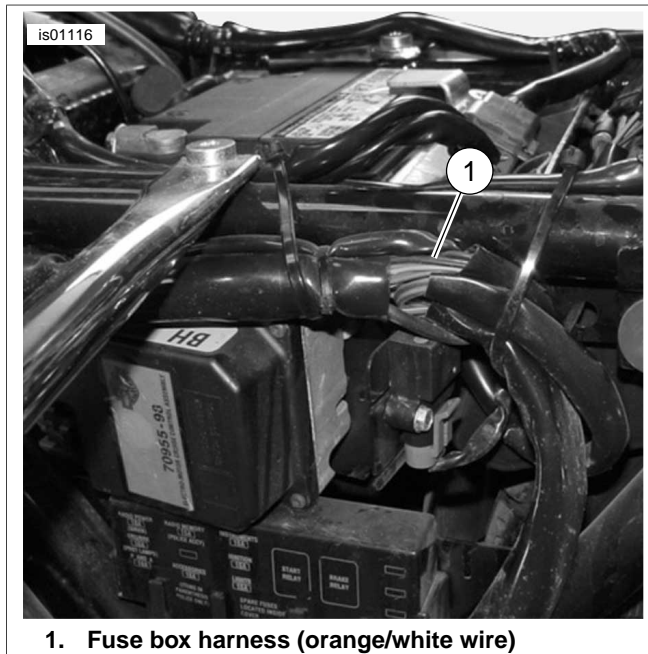

Figure 12. Fuse Box Harness Behind Left-Hand Side Cover, 2003 or Earlier Touring Models (FLHTCUI Shown)

2004-2007 Touring Models

The heated hand grip **switched** power source is an open fuse position on the fuse panel. See the FUSES section of the service manual and the correct wiring diagram in the service manual appendix.

- For 2004-2006 models:** Remove the left side cover per service manual instructions to access the fuse box.

For 2007 models: Remove the right side cover per service manual instructions to access the fuse box.

For ALL models: Remove the main fuse holder, fuse block and dust cover from the vehicle per service manual instructions.

- Obtain the orange/white fuse block adapter wire (9) from the kit.

For 2004 through 2006 models: Note the terminal on each end (see Figure 13, **upper view**). Only the terminal **WITHOUT** the spring tabs will fit into the fuse cavity. Carefully cut the terminal **WITH** spring tabs from the wire and discard it.

For 2007 models: Note the terminal on each end (see Figure 13, **lower view**). Only the terminal **WITH** the spring tabs will fit into the fuse cavity. Carefully cut the terminal **WITHOUT** spring tabs from the wire and discard it.

- ALL models:** See Figure 14. Locate the fuse cavity marked "P&A IGN", "2A MAX" (1). There is a bus bar feeding one side of this circuit, but no mating wire or fuse

will be present. Remove the three fuses (2) currently installed in this row, noting their location.

- Gently remove the orange plastic secondary lock from the fuse block. Insert the terminal on the orange/white adapter wire until it stops. Refer to a nearby factory installed terminal for comparison to verify proper orientation and depth. Install the secondary lock.
- Install the secondary lock and three fuses removed in the previous steps.
- See Figure 22. Cut the excess length from the orange/white heated hand grip harness wire. Using a sealed splice connector (3) from the kit, splice that wire to the adapter wire installed in Step 4.
- Install the 2A fuse (12) from the kit into the fuse cavity marked "P&A IGN", "2A MAX" to complete the circuit.
- Proceed to **For ALL models** in this section.

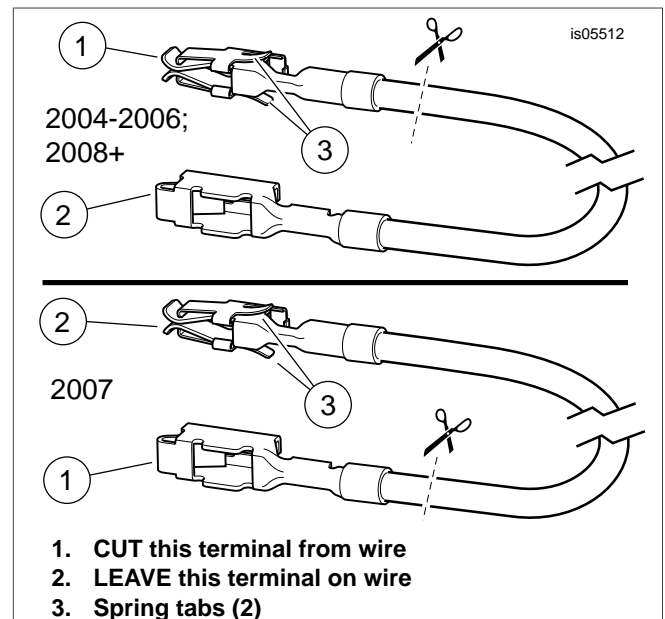

Figure 13. Fuse Block Adapter Wire (FL Touring)

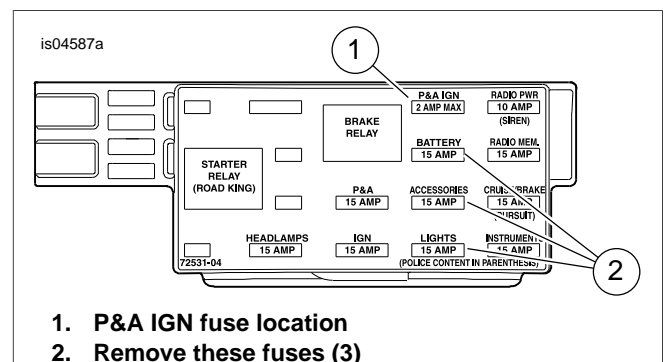

Figure 14. P&A IGN Fuse Cavity (2004-2007 Touring Models)

V-Rod Models

The heated hand grip **switched** power source is an orange/white (O/W) main harness power lead coming from the fuse block.

- See Figure 15. Carefully slice open an area of the main harness wrap near the fuse block (2) at an accessible point, and cut the orange/white main harness wire leading to the fuse cavity (1) marked:
 - ACCESSORIES on 2002-2006 models, or
 - P&A IGNITION on 2007 and later models.
- Cut the excess length from the orange/white power lead of the heated hand grip wire harness to within easy reach of the cut orange/white wires at the fuse block.
- See Figure 22. Obtain a sealed splice connector (3) from the kit.

See Figure 7, the two into one splice configuration. Splice the heated hand grip wire harness power lead, to the main harness orange/white wires per the instructions in the service manual appendix.
- Install the 2A fuse (12) from the kit into the fuse cavity to complete the circuit.

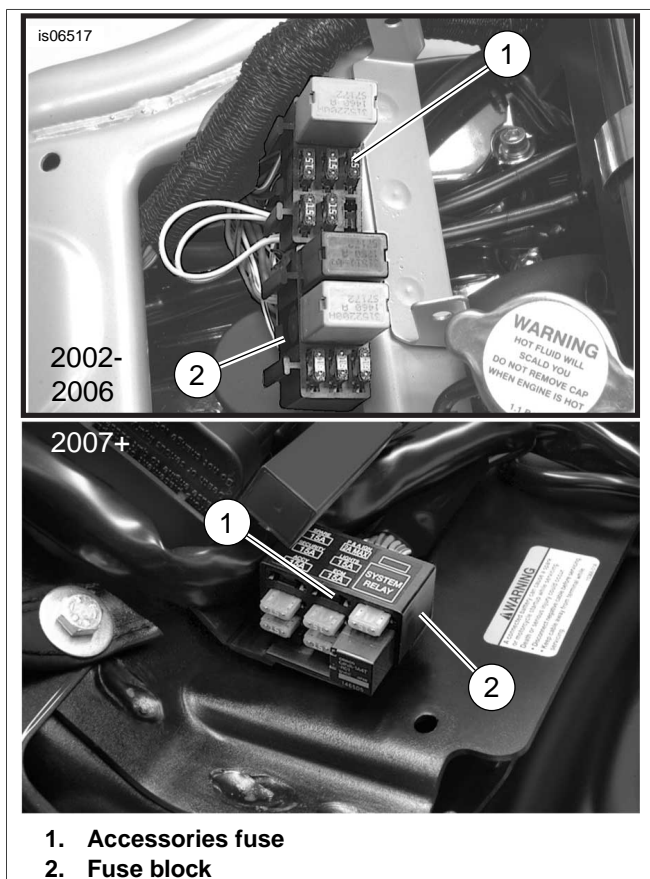

Figure 15. Accessory Fuse Locations (V-Rod Models)

For ALL models

Verify that there is sufficient slack in the orange/white lead so that handlebar movement will not be restricted.

Proceed to the **RED LEAD CONNECTION** section for the specific model.

RED LEAD CONNECTION TO BATTERY POWER SOURCE

Use the service manual wiring diagrams for a specific model and year vehicle to locate a power source that is fed directly from the battery.

2003-Earlier Dyna Models

The heated hand grip **battery** power source is the **silver** terminal of the circuit breaker inside the electrical side cover.

- See Figure 16. Route the heated hand grip harness red wire through the top of the frame under the seat to the circuit breaker on the inside of the electrical side cover.
- See Figure 22. Select the correct ring terminal (4, 5 or 6) from the kit to fit the silver terminal stud (with the red wire) on the circuit breaker.
- Cut the excess length from the heated hand grip harness red wire, but DO NOT cut off the in-line fuse holder.

Crimp the ring terminal to the end of the red wire per the Packard crimping tool instructions in the service manual appendix.

NOTICE

The power wire (red) from the heated-handgrip wire harness must connect to the circuit-breaker silver terminal. Connecting to the circuit-breaker copper terminal can cause circuit overload, which could result in equipment damage. (00370a)

- Install the red wire ring terminal onto the threads of the circuit breaker silver terminal stud, and tighten to 20-35 in-lbs (2.3-4.0 Nm).

- Proceed to **For ALL models** in this section.

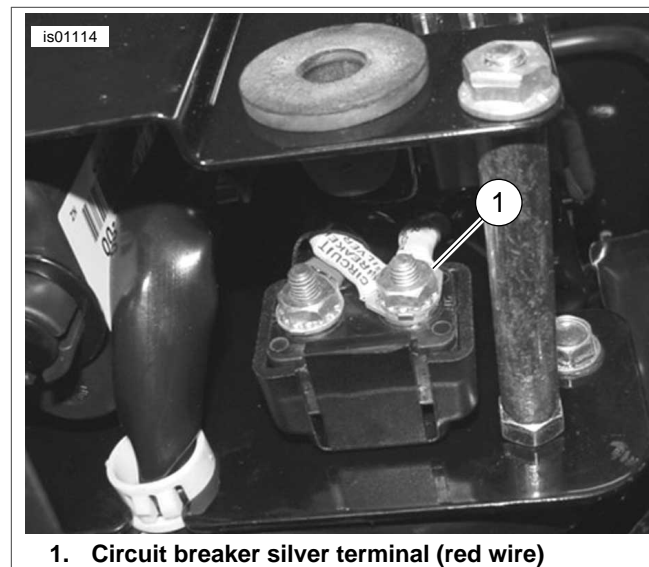

Figure 16. Dyna Connections (2003 and Earlier Models), Bottom View with Left Side Cover Removed

2003-Earlier Softail Models

The heated hand grip **battery** power source is the **silver** terminal of the circuit breaker located near the front of the rear fender splash guard below the seat.

1. See Figure 17. Remove the rear fender splash guard (1) per the instructions in the service manual.
2. See Figure 18. Route the heated hand grip wire harness red wire through the right side top of the frame, under the seat, and to the circuit breaker located near the front of the rear fender splash guard below the seat.
3. See Figure 22. Select the correct ring terminal (4, 5 or 6) from the kit to fit the silver terminal stud (with the red wire) on the circuit breaker.
4. Cut the excess length from the heated hand grip harness red wire, but DO NOT cut off the in-line fuse holder.
Crimp the ring terminal to the end of the red wire per the Packard crimping tool instructions in the service manual appendix.

NOTICE

The power wire (red) from the heated-handgrip wire harness must connect to the circuit-breaker silver terminal. Connecting to the circuit-breaker copper terminal can cause circuit overload, which could result in equipment damage. (00370a)

5. Install the red wire ring terminal onto the threads of the circuit breaker silver terminal stud, and tighten to 20-35 in-lbs (2.3-4.0 Nm).
6. Proceed to **For ALL models** in this section.



Figure 17. Splash Guard, 2003 or Earlier Softail Models (2003 Model Shown)

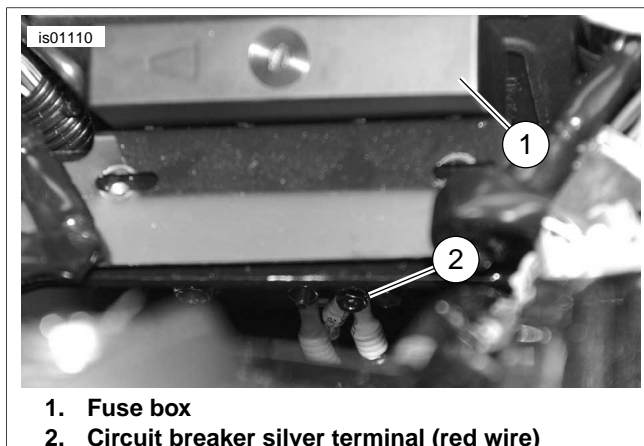

Figure 18. Circuit Breaker (2003 or Earlier Softails)

2003-Earlier Sportster Models

The heated hand grip **battery** power source is the **silver** terminal of the circuit breaker inside the electrical side cover. See Figure 19 and Figure 11.

1. See Figure 22. Select the correct ring terminal (4, 5 or 6) from the kit to fit the silver terminal stud (with the red wire) on the circuit breaker.
2. Cut the excess length from the heated hand grip harness red wire, but DO NOT cut off the in-line fuse holder.
Crimp the ring terminal to the end of the red wire per the Packard crimping tool instructions in the service manual appendix.

NOTICE

The power wire (red) from the heated-handgrip wire harness must connect to the circuit-breaker silver terminal. Connecting to the circuit-breaker copper terminal can cause circuit overload, which could result in equipment damage. (00370a)

3. Install the red wire ring terminal onto the threads of the circuit breaker silver terminal stud, and tighten to 20-35 in-lbs (2.3-4.0 Nm).
4. Proceed to **For ALL models** in this section.

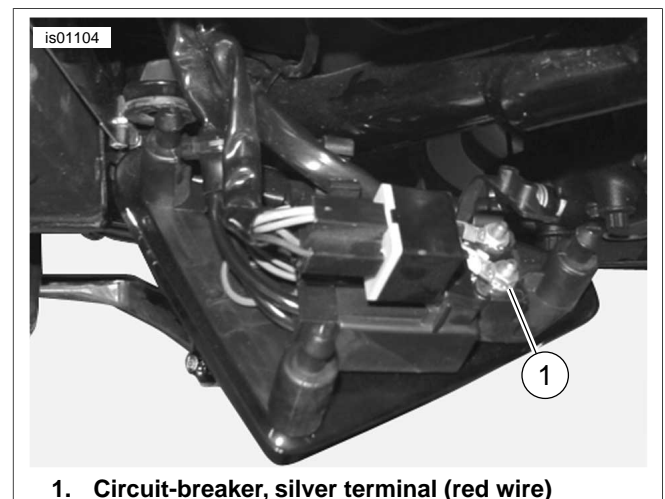

Figure 19. Circuit Breaker (2003 or Earlier Sportsters)

2003-Earlier Touring Models

The heated hand grip **battery** power source is the **silver** terminal of the circuit breaker in the battery well under the seat.

1. See Figure 5. Route the heated hand grip red wire to the silver terminal stud (1) of the circuit breaker, located in the battery well under the seat.
2. See Figure 22. Select the correct ring terminal (4, 5 or 6) from the kit to fit the silver terminal stud (with the red wire) on the circuit breaker.
3. Cut the excess length from the heated hand grip harness red wire, but DO NOT cut off the in-line fuse holder.
Crimp the ring terminal to the end of the red wire per the Packard crimping tool instructions in the service manual appendix.

NOTICE

The power wire (red) from the heated-handgrip wire harness must connect to the circuit-breaker silver terminal. Connecting to the circuit-breaker copper terminal can cause circuit overload, which could result in equipment damage. (00370a)

4. Install the red wire ring terminal onto the threads of the circuit breaker silver terminal stud, and tighten to 20-35 in-lbs (2.3-4.0 Nm).
5. Install the battery back into the vehicle, but DO NOT connect the battery terminals at this time.
6. Proceed to **For ALL models** in this section.

2004-2010 Softail Models, 2004-2011 Dyna Models, 2004-2013 Sportster Models and 2004-2013 Touring Models

The heated hand grip **battery** power source is the B+ (battery positive) connector on the main electrical harness.

1. See Figure 20. Locate the B+ (battery positive) connector (1) (a red wire with an unused gray connector) on the main electrical harness,
 - a. **For Dyna and Softail models:** under the seat
 - b. **For Sportster and Touring models:** routed under the seat, beneath the ECM (Electronic Control Module).

Remove the cover (2) from the connector.

2. See Figure 22. Plug the adapter harness (10) from the kit into the B+ connector.
3. Cut the heated hand grip harness red wire to within easy reach of the end of the adapter harness red wire, but DO NOT cut off the in-line fuse holder.
4. Obtain a sealed splice connector (3) from the kit.
See Figure 7, the one into one splice configuration. Splice the heated hand grip red wire to the adapter wire per the instructions in the service manual appendix.
5. Proceed to **For ALL models** in this section.

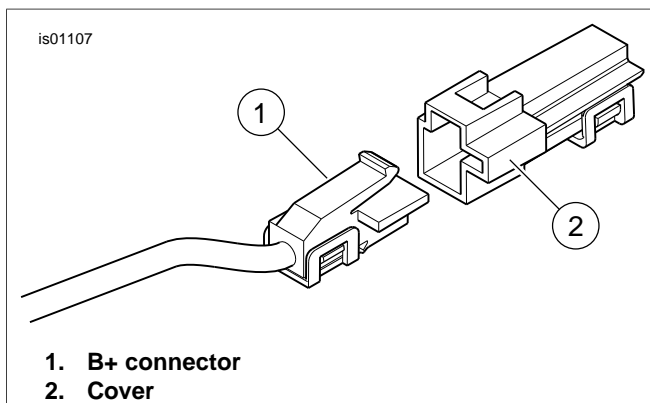

Figure 20. B+ Connector

V-Rod Models

The heated hand grip harness **red** wire connects directly to the battery positive terminal.

1. Select the correct ring terminal (4, 5 or 6) from the kit to fit the positive terminal fastener on the battery.
2. Cut the heated hand grip harness red wire to within easy reach of the battery positive terminal, but DO NOT cut off the in-line fuse holder.
Crimp the ring terminal to the end of the red wire per the Packard crimping tool instructions in the service manual appendix.
3. Fasten the red wire ring terminal to the positive terminal mounting post on the battery. Tighten the terminal fastener to 60-96 in-lbs (7-10 Nm).

For ALL models

Verify that there is sufficient slack in the red lead so that handlebar movement will not be restricted.

Proceed to the next section.

RETURN TO SERVICE

NOTE

DO NOT perform the following steps until the heated hand grips and all related wiring have been installed per the procedures outlined in this instruction sheet for your model motorcycle.

1. Verify that the right grip/throttle sleeve rotates and returns freely and does not bind on the handlebar or switch housing. DO NOT operate the vehicle unless the throttle functions properly.

NOTE

Verify that the ignition switch is in the OFF position before installing the main fuse or attaching the battery cables.

WARNING

Connect positive (+) battery cable first. If positive (+) cable should contact ground with negative (-) cable connected, the resulting sparks can cause a battery explosion, which could result in death or serious injury. (00068a)

2. **For 2003-earlier Touring models only:** Refer to the service manual to attach the battery cables (positive cable first).

Apply a light coat of petroleum jelly or corrosion retardant material to battery terminals.

For ALL OTHER models:

Models with main fuse: Refer to the service manual to install the main fuse.

Models with main circuit breaker (EXCEPT Sportster): Refer to the service manual and follow the instructions to attach the negative battery cable.

Apply a light coat of petroleum jelly or corrosion retardant material to battery terminals.

Sportster models with main circuit breaker: Refer to the service manual, and follow the instructions to connect the negative battery cable at the engine crankcase.

3. **For V-Rod models only:** Install the air box aluminum cover per service manual instructions.
- For ALL OTHER models:** Install the fuel tank per service manual instructions.
4. Install the handlebar cover, riser cover or outer fairing, if equipped, per service manual instructions.

NOTE

To prevent battery drain, the heated hand grips are designed to function only with the ignition switch ON. The hand grips produce maximum heat with the engine at cruising rpm.

The heat settings on the heated hand grip control dial range from 1 (minimum) to 6 (maximum).

5. With the ignition switch OFF, dial the left grip to a number setting.
Check that the hand grips are not producing heat.
Dial the hand grip to the off position. Turn ignition ON, but do not start the motorcycle.
Check that the hand grips are not producing heat.
6. Start the engine. Check the hand grips at all settings for proper heating.
7. Tuck loose wiring into protected areas under the seat. Use cable straps to keep wires away from moving parts, heat sources, and pinch or chafe points.

WARNING

After installing seat, pull upward on seat to be sure it is locked in position. While riding, a loose seat can shift causing loss of control, which could result in death or serious injury. (00070b)

8. Refer to the service manual and follow instructions to close or install the seat.

TROUBLESHOOTING

See Figure 21 for the heated hand grip schematic diagram.

Hand Grips Do Not Produce Heat

1. See Figure 1. Check for proper wire routing. The hand grip main harness must be routed outside of the switch housing. If the wires were routed internally, disassemble the left side switch housing and inspect for pinched wires.
If wires are pinched, replace the left side grip and repeat the installation process with the correct wire routing.
2. Check the wire connections of the orange/white, red and black hand grip main wire harness wires. If a connection is open or weak, repair the connection. Test the hand grips. Otherwise, go to Step 3.
3. Open or remove the seat per service manual instructions.
4. Start the motorcycle.

5. Check for 12 Volts DC across the red and black wires of the hand grip main wire harness. If 12 VDC is not present across the wires, check the fuse in the wire harness and replace it if blown. Otherwise, replace the left grip and wire harness and test the hand grips.
6. Remove the right side hand grip from the handlebar.
7. Disconnect the connector on the right side grip from the left side grip wire harness.
8. Check continuity across the two-connector leads in the right side grip. If the test shows continuity, the hand grips are functional.

Hand Grips Produce Heat with Ignition Switch Off

If the hand grips produce heat with the ignition switch off, then either the hand grips are incorrectly wired to the vehicle, or the left side grip and wire harness are faulty.

Carefully check all heated hand grip wire connections on the vehicle. If the connections are correct, replace the heated hand grip main wire harness, then test the hand grips.

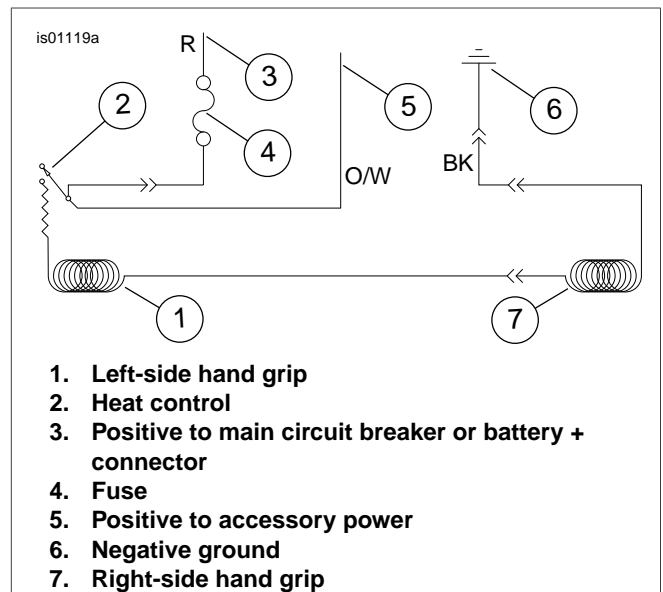

Figure 21. Heated Hand Grip Schematic

SERVICE PARTS

See Figure 22 and Table 1.

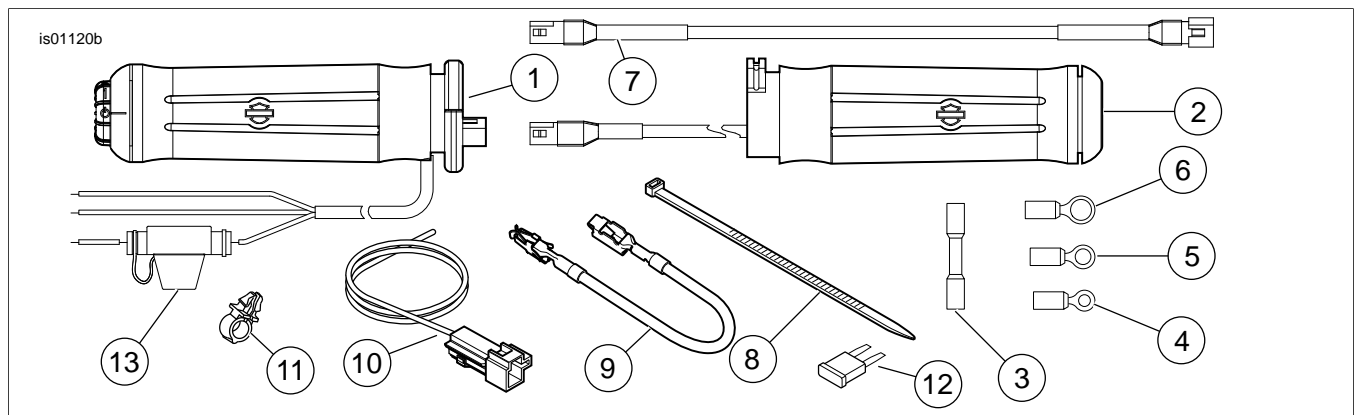

Figure 22. Service Parts, Heated Hand Grip Kits

Table 1. Service Parts

Item	Description (Quantity)	Part Number
Kit 56047-03C: Flame Heated Hand Grips		
1	Heated hand grip, left	56100-04B
2	Heated hand grip, right	56048-03
Kit 56107-03B: Smooth Grain Leather Heated Hand Grips		
1	Heated hand grip, left	56169-04A
2	Heated hand grip, right	56136-03
Kit 56174-03C: Chrome/Rubber (Large Diameter) Grips		
1	Heated hand grip, left	56181-04B
2	Heated hand grip, right	56175-03
Kit 56196-03C: Chrome/Rubber (Small Diameter) Grips		
1	Heated hand grip, left	56617-04A
2	Heated hand grip, right	56615-03
Kit 56512-02C: Contoured Chrome/Rubber Heated Grips		
1	Heated hand grip, left	56514-04A
2	Heated hand grip, right	56513-02
Kit 56619-03B: Nostalgic Heated Hand Grips		
1	Heated hand grip, left	56638-03A
2	Heated hand grip, right	56620-03
Kit 56694-04A: Diamond Plate Heated Hand Grips		
1	Heated hand grip, left	56695-04A
2	Heated hand grip, right	56696-04
Kit 56750-04B: Stealth Heated Hand Grips		
1	Heated hand grip, left	56734-04A
2	Heated hand grip, right	56733-04
Kit 56828-03B: Aileron Heated Hand Grips		
1	Heated hand grip, left	56830-03A
2	Heated hand grip, right	56829-03
Kit 56923-05: H.O.G.® Heated Hand Grips		
1	Heated hand grip, left	56924-05

Table 1. Service Parts

Item	Description (Quantity)	Part Number
2	Heated hand grip, right	56925-05
Kit 56926-05A: Skull Heated Hand Grips		
1	Heated hand grip, left	56927-05
2	Heated hand grip, right	56928-05
Kit 56997-07A: Ironside Heated Hand Grips		
1	Heated hand grip, left	57055-07
2	Heated hand grip, right	56053-07
Kit 56100030: Slipstream Heated Hand Grips		
1	Heated hand grip, left	56100038
2	Heated hand grip, right	56100033
Kit 56100111: Airflow Heated Hand Grips		
1	Heated hand grip, left	56100109
2	Heated hand grip, right	56100127
Parts common to ALL Heated Hand Grip Kits		
3	Sealed splice connector (2)	70586-93
4	Ring terminal (2), for #10 stud	9857
5	Ring terminal (2), for 1/4 inch (6.4 mm) stud	9858
6	Ring terminal, for 5/16 inch (7.9 mm) stud	9859
7	Wire harness extension, 10.5 inch (26.7 cm) long	70259-02
8	Cable strap (black) (8), 10.5 inches (26.7 cm) long	10006
9	Wire, fuse block adapter	70329-04
10	Wire harness, adapter	70310-04
11	Clip, wire retainer (4)	70345-84
12	Fuse, blade type, 2A (gray)	54305-98
13	Fuse, blade type, 5A (light tan) (inside fuse holder)	72331-95