

*OPERATING AND INSTALLATION MANUAL*

## **CHEST FREEZER**

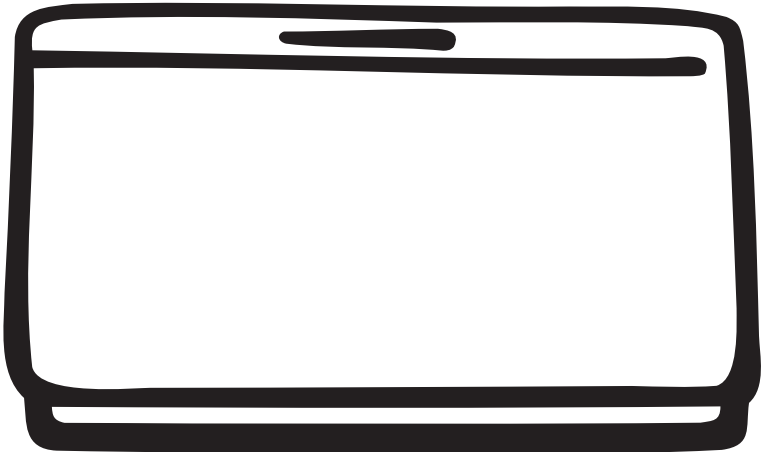

**ECN 4157**  
**ECN 5157**

 **Electrolux**

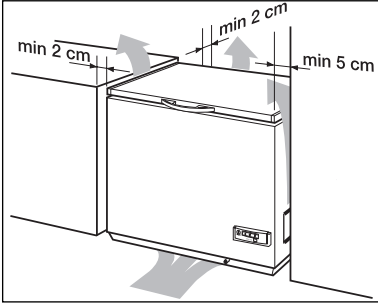

1.

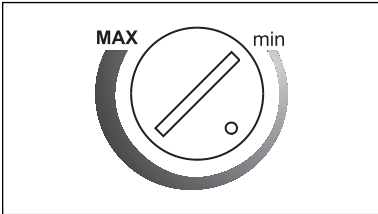

2.

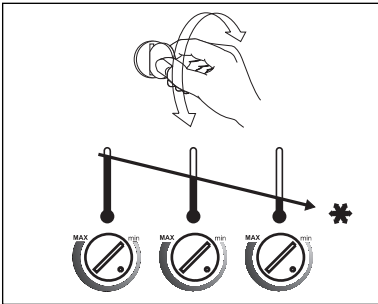

3.

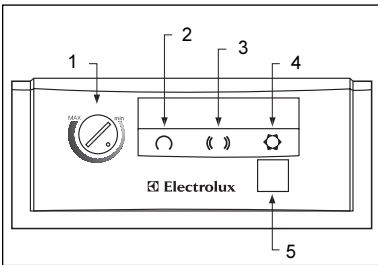

4.

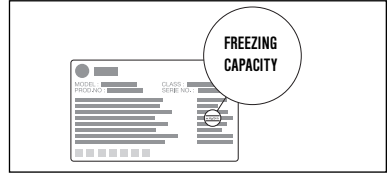

5.

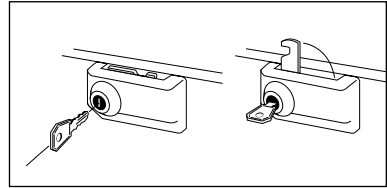

6.

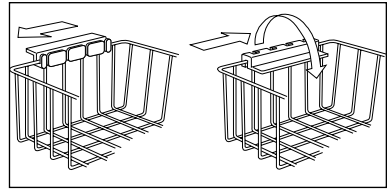

7.

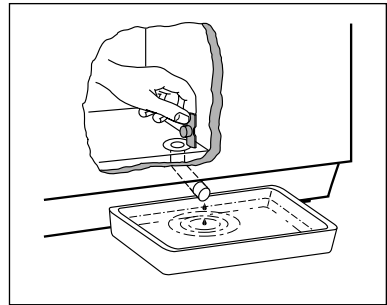

8.

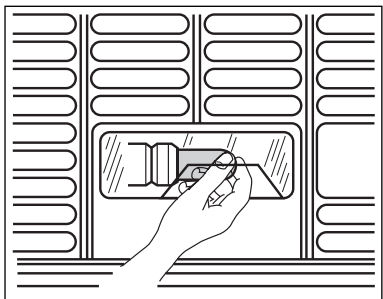

9.

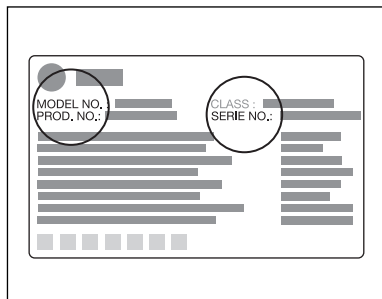

10.

## CONTENTS

<b>TECHNICAL SPECIFICATIONS</b> .....	4
<b>SAFETY INSTRUCTIONS</b> .....	5
Warnings and Guidelines.....	5
<b>INSTALLATION</b> .....	5
Position.....	5
Electrical connections.....	6
Switching On.....	6
<b>HOW TO USE</b> .....	6
Temperature Control.....	6
Opening/Closing the Lid.....	6
Control Panel.....	6
Freezing.....	6
Packaging and Positioning.....	6
Capacity.....	6
Lock.....	7
Baskets.....	7
<b>HELPFUL HINTS</b> .....	7
Storage.....	7
Freezing.....	7
Defrosting.....	7
Accessories.....	7
<b>MAINTENANCE</b> .....	7
Defrosting.....	7
How to Clean Your Freezer.....	7
When Not in Use.....	8
<b>IF SOMETHING DOES NOT WORK</b> .....	8
How to Change the Bulb.....	8
<b>Service and Spare Parts</b> .....	9
<b>Electrical Connection</b> .....	11

## TECHNICAL SPECIFICATIONS

Model		ECN 4157	ECN 5157			
Volume (gross)	litres	414	514			
Volume (net)	litres	404	502			
Height without/with roller	cm	87,6/88,3	87,6/88,3			
Width	cm	132,5	160			
Depth	cm	66,5	66,5			
Weight	kg	56	66			
Energy consumpt./24h	kWh	1,395	1,814			
Freezing capacity	kg/24h	19	24			
Hold-over time	hours	32	32			
Rated power	W	105	130			

Before installing and using the appliance read this user's instruction book carefully. It contains safety precautions, hints, information and ideas. If the refrigerator is used in compliance with the instructions written, it will operate properly and provide you with greatest satisfaction.

The symbols below help you to find things more easily:



### Safety precautions

Warnings and information at this symbol serve safety for you and your appliance.



### Hints, useful information



### Environmental information

# SAFETY INSTRUCTIONS

## WARNINGS AND GUIDELINES

These warnings are provided to improve safety, and should be read carefully before installing or using your freezer.



### IMPORTANT

It is vital that these instructions are kept with the freezer for future use. If the freezer is sold or given to another user, or if you move and leave the freezer behind, you must ensure that the instructions accompany the freezer to enable the next user to use the freezer correctly and read the relevant warnings.

- This freezer is only intended for the freezing and storage of food.
- This freezer should only be operated by adults. Children must not be allowed to tamper with the control buttons or play with the freezer.
- Changes in the electrical mains system in connection with the installation of this freezer should always be carried out by an authorised electrician or competent person.
- Do not under any circumstances attempt to repair the freezer yourself. Repairs carried out by untrained people may result in personal injury or serious malfunction of the freezer.
- Service of the freezer should be carried out by an authorised service company, and only original spare parts should be used. See under "Guarantee Conditions and Service".
- It is dangerous to alter the freezer specifications, or to change the freezer in any other way.
- Make sure that the freezer is not placed on top of the mains cable.
- Do not re-freeze food once it has been defrosted.
- Observe the recommendations for storage carefully. See under "Helpful Hints".
- This freezer includes components that are heated during operation. Consequently, adequate ventilation must always be provided. If ventilation is insufficient defects may occur, resulting in the loss of food. See under "Installation".
- The inside of the freezer contains pipes through which coolant flows. If these pipes are punctured the freezer may be damaged beyond repair, and food may be lost. Do not use sharp implements to remove frost or ice. Frost can be removed using the enclosed scraper. Do not knock ice off the sides of the freezer, but remove it by defrosting the freezer. See under "Maintenance".
- Do not place drinks in the freezer. Bottles and cans containing carbonic acid or sparkling drinks are particularly prone to explosion, which may damage the freezer.
- This freezer is heavy. Take care when moving it.
- If the freezer is fitted with a lock to prevent tampering by children, the key must always be kept safely out of the reach of children, and far away from the freezer.

- Before disposing of an old freezer, make sure that the lock (if present) no longer works. This is to prevent accidents and avoid the danger of children getting locked inside.
- Ice lollies can cause frostbite if eaten direct from the freezer.
- **Make sure that the power plug is not squashed or damaged by the back of the fridge/freezer.**
  - A damaged power plug may overheat and cause a fire.
- **Do not place heavy articles or the fridge/freezer itself on the power cord.**
  - There is a risk of a short circuit and fire.
- **Do not remove the power cord by pulling on its lead, particularly when the fridge/freezer is being pulled out of its niche.**
  - Damage to the cord may cause a short-circuit, fire and/or electric shock.
  - If the power cord is damaged, it must be replaced by a certified service agent or qualified service personnel.
- **If the power plug socket is loose, do not insert the power plug.**
  - There is a risk of electric shock or fire.

## REFRIGERANT

Your appliance contains an environmental friendly natural gas, isobutane (R600a) as refrigerant, which is nevertheless flammable.

- During transportation and installation of the appliance, be sure that none of the components of the cooling circuit become damaged.
- If any part of the cooling circuit damaged:
  - avoid naked flames and sources of ignition;
  - thoroughly ventilate the room in which the appliance is installed.

## INSTALLATION

### POSITION (1)

- Place the freezer horizontally on a firm surface, resting on all four plastic feet. Use a wooden block or similar object to compensate for any bumps/holes in the surface.
- The room should be dry and adequately ventilated.
- If the room temperature exceeds 43 °C, or falls below freezing point, the freezer will not function as it should.

Climate category	Ambiente temperature from ... to
SN	+10 to + 32 °C
N	+16 to + 32 °C
ST	+18 to + 38 °C
T	+18 to + 43 °C

- Do not place the freezer close to sources of heat, radiators, chimneys, etc., and do not place the freezer in direct sunlight.
- If the freezer has been handled standing on end it should be allowed to stand in normal position for about 12 hours before switching it on.

- Please ensure that when the appliance is installed it is easily accessible for the engineer in the event of a breakdown.

## SWITCHING ON (2)

Before switching on, the freezer should be cleaned inside. See under "Maintenance".

Set the thermostat button in middle position. Allow the freezer to run for several hours before placing food inside.

## ELECTRICAL REQUIREMENTS

Before switching on, make sure that the voltage of your electricity supply is the same as that indicated on the rating plate, located inside the lid.

 This appliance complies with the following EC Directives:

- 73/23/EEC of 19. 02. 1973 - Low-Voltage Directive
- 89/336/EEC of 03. 05. 1989 (including Amendment Directive 92/31/EEC - EMC Directive).

Some of the models are not available in all countries. Testing has been carried out in accordance with ISO 5155 regarding the determination of freezer capacity, energy consumption and hold-over time.

Information for test institute: A plan of the positioning of test packages may be obtained directly from the manufacturer.

## HOW TO USE

### TEMPERATURE CONTROL (3)

 The thermostat ensures that the required temperature is maintained in the freezer. Adjust the temperature by turning the button with a coin that fits the groove. Turning the thermostat button towards „MAX“ makes the temperature in the freezer colder, and turning the button towards „min“ makes the temperature warmer. The correct setting can be found by measuring the temperature of the top package in the middle of the freezer. This should not have a temperature higher than -18°C.

### OPENING/CLOSING THE LID

 The lid is fitted with a tightly closing sealing strip to prevent moisture getting inside the freezer and increasing the amount of frost formed.

When the lid is opened the air inside the freezer becomes slightly warmer and expands.

As soon as the lid is closed again the air is cooled immediately.

This may lead to the creation of a vacuum which makes it hard to open the lid immediately after it has been closed. This is quite normal.

Wait a few minutes until the vacuum has disappeared, then open the lid by pulling gently. Never pull the handle violently.

### CONTROL PANEL (4)

 The green light is illuminated as long as the freezer is connected.

The yellow light is illuminated when the "Super" button is depressed. See under "Freezing".

The red light is illuminated when the temperature in the freezer is higher than the thermostat setting (alarm).

1. Thermostat button
2. Green light
3. Red light
4. Yellow light
5. "SUPER"

The red alarm light can be due to:

- Insertion of a large amount of fresh food. The red alarm light will go out after a while.
- Opening the lid too long. The red alarm light will go out after a while.
- A defect in the system. See under "If something does not work".

## FREEZING

 It is important that fresh food placed in the freezer is frozen quickly, and that the food already in the freezer is heated as little as possible in this connection.

If more than 3-4 kg of food is to be frozen:

- Press the square "Super" button (yellow light comes on). The freezer will now run continuously, creating a sufficient reserve of the temperature required.
- Press the "Super" button 6-24 hours before placing fresh food in the freezer, depending on how much food is to be frozen.
- Place the food in the freezer and leave the "Super" button on for about 24 hours more.
- Then press the "Super" button again (yellow light goes off). The freezer will return to normal storage temperature. If you forget to press the "Super" button again, the freezer will not be damaged by running at the "Super" setting for some time - but energy will be wasted.

## HOW TO USE

### PACKAGING AND POSITIONING

- Food must be cold before freezing (no more than room temperature).
- Food must be packed in airtight and moisture-proof packaging to prevent it from drying out.
- Place fresh food for freezing close to the cold sides of the freezer, making sure that it is not in contact with the frozen food already in the freezer.
- Never fill the freezer to more than 5 mm below the top edge.

See under "Helpful hints".

### CAPACITY (5)

The freezing capacity of the freezer is stated in the data plate (kg/24 hours). Do not exceed the amount stated - if you do, the freezing time will be extended. The data plate is located inside the lid.



### IMPORTANT

The freezing capacity stated can be utilised to the full occasionally to freeze large amounts of fresh food. However, if the freezer is filled with large

**amounts of food for freezing every day, the capacity stated is reduced by about one-third.**

## LOCK (6)

(Not a standard accessory for all models.) The lock works as shown in the drawings. Remember to keep the key out of the reach of children.

## BASKETS (7)

The baskets are designed for the storage of food which has already been frozen. The handles can be placed in two positions, as shown in the drawings.

The baskets can either be placed inside the freezer or hung on the edge of the casing.

## HELPFUL HINTS (9)

### STORAGE

 Frozen food can be stored anywhere inside the freezer, but should be kept at least 5 mm below the top edge. Never exceed the maximum storage time for purchased frozen food. When you buy frozen food, make sure that it has been stored at the correct temperature. Do not buy products which have wet or damaged packaging. Place purchased products in your freezer as quickly as possible. We recommend using an insulated bag to bring such products home with you. Never place bottles, warm objects, or fizzy drinks in the freezer.

### FREEZING

 Only use fresh food of the best quality. Cool hot dishes to room temperature as quickly as possible before placing them in the freezer. Wrap food carefully in freezer foil, or use the special freezer boxes or bags which are on the market. Divide food into small portions before freezing - this ensures that freezing is more rapid, and means that you only need to defrost the amount needed for immediate consumption. Remember that defrosted food must not be re-frozen. However, dishes which have been made using defrosted food may be frozen. Mark the freezer packaging with the date of freezing. We recommend keeping a record of the contents of your freezer. If freezing is too slow, the quality of the food being frozen deteriorates. Consequently, do not freeze larger amounts than stated in the freezer's data plate. If you wish to freeze food several days in a row, the maximum freezing capacity stated per day is reduced by about one-third. As far as possible, keep the lid closed during freezing. If you know nothing about home freezing, we recommend that you purchase a book containing advice and guidelines.

### DEFROSTING

 In general food should not be defrosted at room temperature, since this increases the risk of bacteria growth. It is best to defrost large portions of meat or poultry in the refrigerator, and this also applies to food which is to be consumed as it is (e.g. fruit, butter and sliced meat). Small portions of food can be cooked straight from the freezer. A good number of ready-to-cook dishes can also be cooked without defrosting. Always observe the instructions on product packaging. Bread tastes good when defrosted in a moderate oven.

Microwave ovens can be used for the rapid defrosting of most frozen foods. Observe the instructions for use of the microwave oven concerned.

## ACCESSORIES

 Spare baskets can be obtained from your local Service Centre.

## MAINTENANCE

### DEFROSTING (8)

The formation of frost on the inside of freezers cannot be avoided. Frost is formed when moisture contained in the air comes into contact with the cold surfaces of the freezer.

Consequently, the lid should only be opened when necessary, and it should never be left open.

A thin layer of ice or frost does not affect the function of the freezer adversely, and can be removed carefully using the scraper provided.

#### IMPORTANT

**Never use a knife or any other sharp implement to remove frost.**

When the frost or ice layer is 10-15 mm thick, the freezer should be defrosted. We suggest that you defrost your freezer when there is little or no food inside.

Switch off the current. Remove the contents of the freezer, wrap them in newspapers, and leave them in a cold place.

The speed of defrosting can be increased by placing one or more bowls of hot (not boiling) water inside the freezer and closing the lid. Open the lid after a while, and remove the layer of ice carefully.

The defrost water can be collected in a bowl as shown in the drawing.

Do not try to speed up defrosting by using anything other than hot water, since this may damage the freezer. After defrosting, clean the inside of the freezer.

#### IMPORTANT

**Remember to replace the plug in the drip water drain.**

### HOW TO CLEAN YOUR FREEZER INSIDE

Remove the plug from the mains socket, and remove all loose accessories before cleaning the freezer.

The best time to clean your freezer is after defrosting and before the electricity supply is connected again.

Use a damp cloth to clean your freezer. Use hot water, and a mild, non-aromatic cleaning agent.

After cleaning the freezer, clean the basket/baskets before replacing them.

#### IMPORTANT

**Never use strong cleaning agents, scouring powder or strongly aromatic cleaning agents to clean your freezer inside, since this will damage the inside and leave a strong smell.**

## EXTERNAL CLEANING

Wash the outer cabinet with warm soapy water. Do NOT use abrasive products.

## WHEN NOT IN USE

- Disconnect the appliance from the electricity supply.
- Remove all goods from the freezer.
- Clean the freezer as described above.
- Leave the lid slightly open.

## IF SOMETHING DOES NOT WORK

### IF YOUR FREEZER DOES NOT FUNCTION SATISFACTORILY

Check the following before calling for service staff:

Defect:	Check if:	Possible cause:	Action:
Freezer not cold enough	Green light not on	Plug not connected correctly	Check plug and socket
		Defect in switch or fuse	Check fuse, call electrician
		Power failure	Wait until current returns
	Green and red light on	Fresh food recently placed in freezer	Wait a couple of hours
		Lid open too long	Wait a couple of hours
Green light on, red light not on	Thermostat set too warm	Set thermostat colder	
	Lot of frost and ice formed	Defrost freezer	
Freezer too cold	Yellow light on	"Super" function active	Press "Super" button out
	Yellow light not on	Thermostat set too cold	Set thermostat warmer
Too much frost formed	Lid does not close completely	Lid in contact with goods in freezer	Re-arrange goods, check that lid closes correctly
	Lot of moisture in the room	Moisture from washing machine, tumble-dryer, etc.	Move freezer to a room with less moisture, or air regularly
	Goods packed poorly	Lot of moisture from goods	Re-pack goods, see under "How to use"

If you are still unable to solve the problem, summon the assistance of authorised service staff.

Do not take any other steps. Incorrect procedure may cause personal injury or lead to additional defects.

It is quite normal for the freezer to seem warm on the outside occasionally, owing to the heat generated by the freezing process. This heat also helps to prevent the formation of moisture on the outside of the appliance which could cause rust.

If the freezer has been switched off briefly, the compressor may not start immediately when the current is re-connected. This is quite normal.

## IN THE CASE OF A POWER FAILURE OR BREAKDOWN

The hold-over period mentioned in the "Technical Specification" section of this book refers to an estimated time the freezer temperature will take to rise to an unacceptable level for keeping frozen foods.

Providing the period of power failure or breakdown does not exceed the hold-over period there will be no risk of damage to the frozen food, providing you do not open the lid during this period.

If the freezer is only half full or the lid is opened this will reduce the hold-over time.

After the breakdown period you are recommended to check the condition of food to ensure it has not started to thaw. Frozen food must NOT be re-frozen once it has thawed out. The following guidelines should assist you.

**Ice cream:** Once thawed should be discarded.

**Fruits & Vegetables:** If soft should be cooked and used up.

**Breads & Cakes:** Can be re-frozen without danger.

**Shellfish:** Should be refrigerated and used up quickly.

**Cooked Dishes:** ie. casseroles should be refrigerated and used up.

**Small Joints:** Should be cooked and can then be re-frozen as cooked dishes.

**Chicken:** Should also be cooked and re-frozen as a cooked dish.

## HOW TO CHANGE THE BULB (9)

Before changing the bulb, isolate the appliance from the electricity supply.

Unscrew the bulb, and replace it with a new bulb (max. 15W). Then reconnect the electricity supply.



## SERVICE AND SPARE PARTS

In the event of your appliance requiring service, or if you wish to purchase spare parts, please contact your local Electrolux Service Force Centre by telephoning:

**0870 5 929929**

Your telephone call will be automatically routed to the Service Force Centre covering your post code area. For the address of your local Service Force Centre and further information about Service Force please visit the website at [www.serviceforce.co.uk](http://www.serviceforce.co.uk).

## CUSTOMER CARE DEPARTMENT

For general enquiries concerning your Electrolux appliance or for further information on Electrolux products, you are invited to contact our Customer Care Department by letter or telephone at the address below or visit the website at [www.electrolux.co.uk](http://www.electrolux.co.uk):

Customer Care Department  
Electrolux  
55-77 High Street  
Slough  
Berkshire  
SL1 1DZ

Tel: 08705 950 950\*

\* calls to this number may be recorded for training purposes

## GUARANTEE CONDITIONS

We, Electrolux undertake that if within 12 months of the date of the purchase this Electrolux appliance or any part thereof is proved to be defective by reason only of faulty workmanship or materials, the company will, at our option repair or replace the same FREE OF CHARGE for labour, materials or carriage on condition that:

- The appliance has been correctly installed and used only on the electrical supply stated on the rating plate.
- The appliance has been used for normal domestic purposes only, and in accordance with the manufacturer's instructions.
- The appliance has not been serviced, maintained, repaired, taken apart or tampered with by any person not authorised by us.
- All service work under this guarantee must be undertaken by a Electrolux Service Force Centre.
- Any appliance or defective part replaced shall become the Company's property.

Home visits are made between **8.30am** and **5.30pm Monday to Friday**. Visits may be available outside these hours in which case a premium will be charged.

## EXCLUSIONS

**This Guarantee does not cover:**

Damage or calls resulting from transportation, improper use or neglect, the replacement of any light bulbs or removable parts of glass or plastic.

- Costs incurred for calls to put right an appliance improperly installed or calls to appliances outside the United Kingdom.
- Appliances found to be in use within a commercial environment, plus those which are the subject of rental agreements.
- Products of Electrolux manufacture which are not marked by Electrolux.

This guarantee is in addition to your statutory and legal rights.

## ELECTROLUX EUROPEAN GUARANTEE

If you should move to another country within Europe then your guarantee moves with you to your new home subject to the following qualifications:

- The guarantee starts from the date you first purchased your product.
- The guarantee is for the same period and to the same extent for labour and parts as exists in the new country of use for this brand or range of products.
- This guarantee relates to you and cannot be transferred to another user.
- Your new home is within the European Community (EC) or European Free Trade Area
- The product is installed and used in accordance with our instructions and is only used domestically, i.e. a normal household.
- The product is installed taking into account regulations in your new country.

Before you move please contact your nearest Customer Care Centre, list below, to give them details of your new home. They will then ensure that the local Service Organisation is aware of your move and able to look after you and your appliances.

France	Senlis	+33 (0)3 44 62 22 22
Germany	Nuremberg	+49 (0)911 323 2600
Italy	Pordenone	+39 (0)1678 47053
Sweden	Stockholm	+46 (0)20 78 77 55
UK	Slough	+44 (0)1753 219 898

## ELECTRICAL CONNECTION

 Any electrical work required to install this appliance should be carried out by a qualified electrician or competent person.

*This appliance must be earthed.*

The manufacturer declines any liability should these safety measures not be observed.

### Electrical Requirements

Before switching on, make sure the electricity supply voltage is the same as that indicated on the appliance rating plate.

The appliance is supplied with a 13amp plug fitted. In the event of having to change the fuse in the plug supplied, a 13amp ASTA approved (BS1362) fuse must be used. Should the plug need to be replaced for any reason. The wires in the mains lead are coloured in accordance with the following code:

Green and Yellow:	Earth
Blue:	Neutral
Brown:	Live

The wire coloured green and yellow must be connected to the terminal marked with the letter "E" or by the earth symbol  or coloured green and yellow.

The wire coloured blue must be connected to the terminal "N" or coloured black.

The wire coloured brown must be connected to the terminal marked "L" or coloured red.

Upon completion there must be no cut, or stray strands of wire present and the cord clamp must be secure over the outer sheath.

