



SERVICE MANUAL

HWH® TOUCH PANEL-CONTROLLED 725 SERIES HYDRAULIC LEVELING SYSTEM

FEATURING:

Single Step Touch Panel Leveling Control
BI-AXIS® Hydraulic Leveling
Straight-Acting Jacks
(Without Dump)
(With Dump)
(With Pilot Dump)

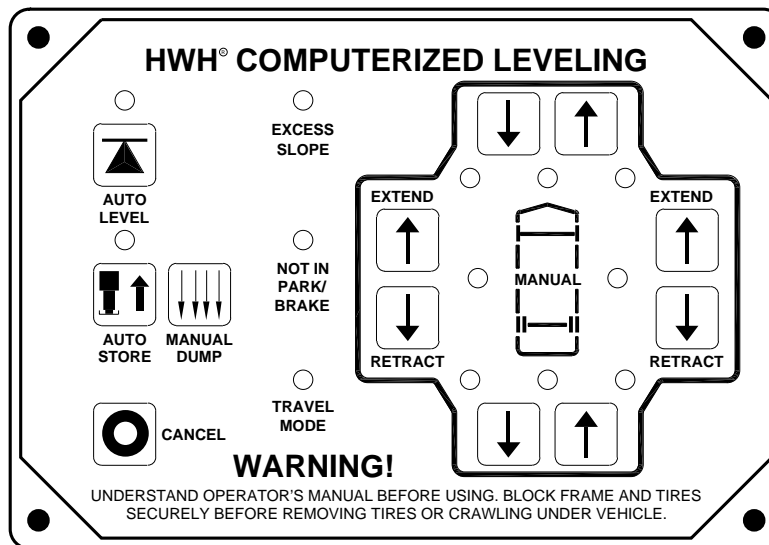

HWH CORPORATION
(On I-80, Exit 267 South)
2096 Moscow Road | Moscow, Iowa 52760
Ph: 800/321-3494 (or) 563/724-3396 | Fax: 563/724-3408
www.hwh.com

SECTION 1

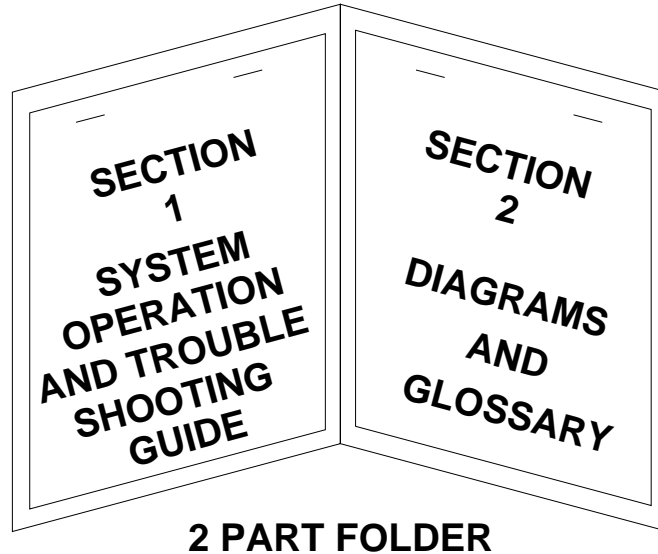

HOW TO USE MANUAL

This manual is written in two sections. Section 1 is System Operation and Trouble Shooting Steps. Section 2 is the Diagrams and Parts Glossary. Begin diagnosis of the system with Section 1. This will give the correct operation and function of the system. The Trouble Shooting Steps are written in order of operation. The Trouble Shooting Steps should be followed in order to avoid improper diagnosis of the system. Section 2 contains diagrams and a parts glossary. Refer to diagrams as directed in the Trouble Shooting Steps. The parts glossary explains the function of individual parts.

IMPORTANT: Plumbing and wiring diagrams are generic in nature. Refer to specific owner's manuals when available or contact HWH Corporation for specific diagrams when necessary.

Before beginning your repair, it is **IMPORTANT** to read the **CAUTIONS** and **NOTES AND CHECKS** in the first section, **TROUBLE SHOOTING GUIDE**. In many cases this will save time and mistakes when trouble shooting a system.

This Repair Manual is offered as a guide only. It is impossible to anticipate every problem or combination of problems. For any problems encountered that are not addressed in this manual, contact HWH Corporation for assistance. (800-321-3494)

PROCEED WITH SYSTEM OPERATION



TROUBLE SHOOTING

WARNING!

BLOCK FRAME AND TIRES SECURELY BEFORE CRAWLING UNDER VEHICLE. DO NOT USE THE LEVELING JACKS OR AIR SUSPENSION TO SUPPORT VEHICLE WHILE UNDER VEHICLE OR CHANGING TIRES. VEHICLE MAY DROP AND OR MOVE FORWARD OR BACKWARD WITHOUT WARNING CAUSING INJURY OR DEATH.

WHEN ROUTING OR REROUTING HYDRAULIC HOSES AND WIRES, BE SURE THEY ARE NOT EXPOSED TO ENGINE EXHAUST OR ANY HIGH TEMPERATURE COMPONENTS OF THE VEHICLE.

NEVER PLACE HAND OR OTHER PARTS OF THE BODY NEAR HYDRAULIC LEAKS. OIL MAY CUT AND PENETRATE THE SKIN CAUSING INJURY OR DEATH.

SAFETY GLASSES ARE TO BE WORN TO PROTECT EYES FROM DIRT, METAL CHIPS, OIL LEAKS, ECT. FOLLOW ALL OTHER SHOP SAFETY PRACTICES.

NOTES AND CHECKS

Read and check before proceeding with Trouble Shooting Steps.

NOTE: HWH CORPORATION ASSUMES NO LIABILITY FOR DAMAGES OR INJURIES RESULTING FROM THE INSTALLATION OR REPAIR OF THIS PRODUCT.

1. If the jacks cannot be retracted, see TROUBLE SHOOTING PART 15 Step 2 for temporary measures. Make sure the manual retract valves are closed before trouble shooting.
2. The Trouble Shooting Guide must be followed in order. Problems checked for in one step are assumed correct and may not be checked again in following steps.
3. Check that the oil reservoir is full with the jacks in the fully retracted position. If the vehicle is equipped with HWH room extensions, refer to the HWH Owners Manual for proper position of the room when checking the oil level.
4. Most coaches have more than one battery; one for the engine and the other(s) for the coach. The engine battery supplies power for the I/O module or touch panel and hydraulic pump. Batteries under no load should read 12.7 volts. Batteries must maintain good voltage under load. Batteries must be in good condition with no weak cells. An alternator, converter or battery charger will not supply enough power for the system to operate properly.
5. Proper grounding of all components is critical. See the electrical circuit for specific grounds required. Faulty grounds, especially for the I/O module, touch panel, solenoid manifold or the pump assembly, may cause component damage and / or improper or erratic operation.

6. Do not replace the I/O module or touch panel unless the Repair Steps say to replace it. Otherwise the malfunctions may damage the new I/O module or touch panel.

This manual is intended for use by experienced mechanics with knowledge of hydraulic and automotive electrical systems. People with little or no experience with HWH leveling systems should contact HWH technical service (800-321-3494) before beginning. Special attention should be given to all cautions, wiring, and hydraulic diagrams.

Special note: When installing a new I/O module or touch panel, make sure the I/O module or touch panel is properly grounded before applying power to the system.

Tightening of hose ends: If tightening a new hose end, make the hose end snug (finger tight) on the fitting, then tighten the hose end 1/3 turn (2 FLATS). If tightening an existing hose end, tighten the hose end to snug plus 1/4 turn (1 FLAT).

Suggested tools for trouble shooting the HWH leveling systems:
JUMPER WIRES TO 10 GAUGE)
PRESSURE GAUGE (PSI MIN.)
MULTI-METER
12 VOLT TEST LIGHT

PROCEED WITH THE TROUBLE SHOOTING STEPS ON THE FOLLOWING PAGE



CONTROL IDENTIFICATION

725 SERIES LEVELING SYSTEM

COMPUTER-CONTROL

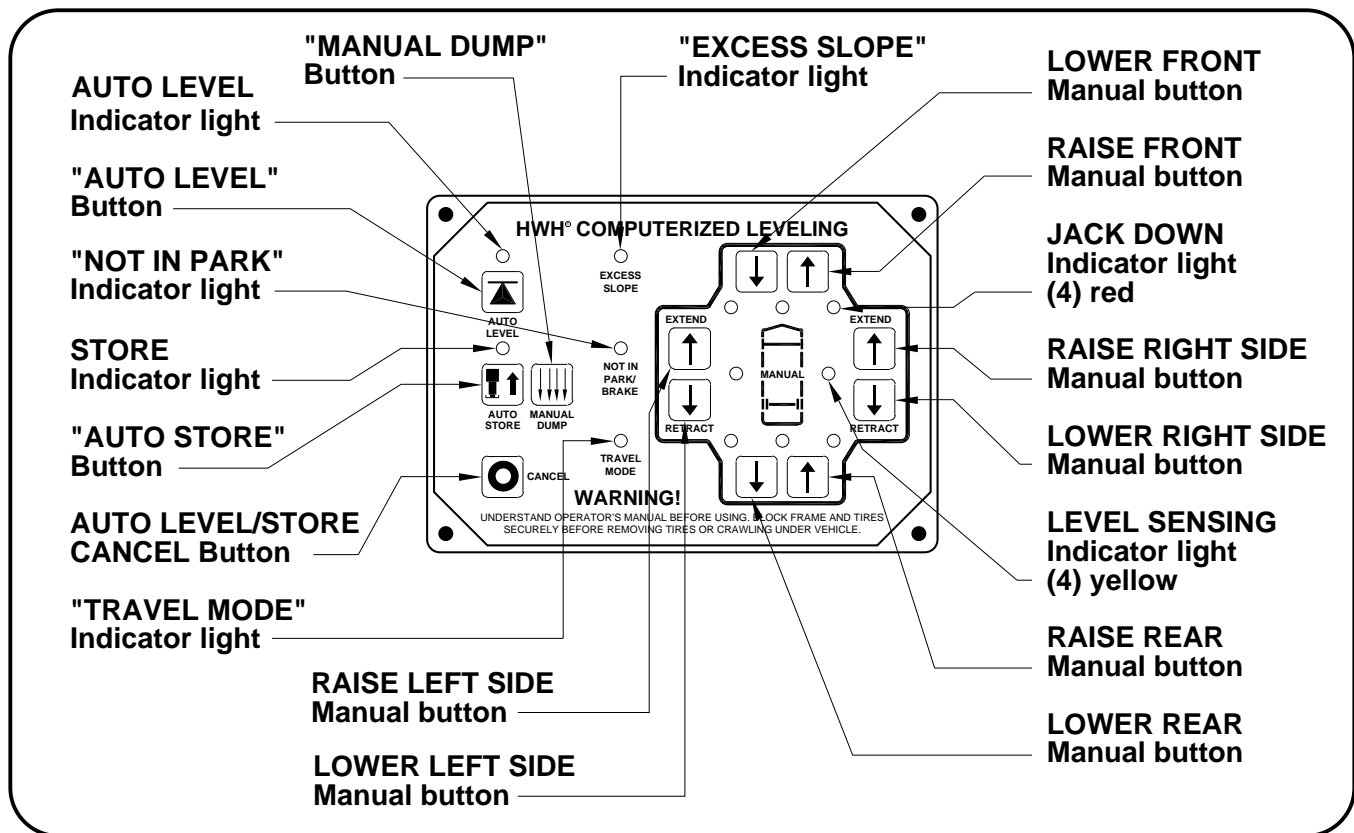

CONTROL FUNCTIONS

CONTROL BUTTONS

"CANCEL" BUTTON: Push this button to stop any leveling system operation.

"AUTO LEVEL" BUTTON: Push this button any time to start the automatic leveling function.

"AUTO STORE" BUTTON: Push this button to retract all four jacks at the same time.

"MANUAL DUMP" BUTTON: This is a manual button for dumping air from the vehicle suspension.

EXTEND BUTTONS (UP ARROWS): These buttons will extend their respective jack pairs to lift the vehicle.

RETRACT BUTTONS (DOWN ARROWS): These buttons will retract their respective jack pairs to lower the vehicle.

INDICATOR LIGHTS

AUTO LEVEL INDICATOR LIGHT: This light will flash during the automatic leveling function.

STORE INDICATOR LIGHT: This light will flash during the automatic store function.

"NOT IN PARK/BRAKE" LIGHT: This indicator will light when the hand/auto brake is not set and the "AUTO LEVEL" button is being pushed.

INDICATOR LIGHTS (CONTINUED)

LEVELING LIGHTS: The four yellow indicating lights are level sensing indicators. When a yellow light is on, it indicates that its side, end, or corner of the vehicle is low. No more than two lights should be on at the same time. When all four yellow LEVEL lights are out, the vehicle is level. SEE OPERATOR'S PROCEDURES - AUTOMATIC HYDRAULIC LEVELING FOR DETAILED EXPLANATION.

WARNING LIGHTS: The four red lights surrounding the yellow level indicators are jacks down WARNING lights. They are functional only when the ignition is in the "ON" or "ACC" position, the system is on, and the jacks are extended 1/4 to 1/2 inch.

"EXCESS SLOPE" LIGHT: This indicator will light when the leveling system cannot level the vehicle.

"TRAVEL MODE" LIGHT: This indicator light will be on when the ignition is on, when the jacks are retracted and there are no red WARNING lights on.

MASTER "JACKS DOWN" WARNING LIGHT: This is a light mounted in the dash separate from the touch panel. It will be on when any one or more jacks are extended and the ignition is "ON".

BUZZER: This is a jacks down warning. It will sound if the master "JACKS DOWN" warning light is on.

SYSTEM OPERATION

The 725 Single Step leveling system is a computer controlled, BI-AXIS push button system. This system has automatic or optional manual control. This system will always extend two (2) jacks at the same time in the automatic or manual mode, both front jacks, the left front and left rear jacks, the right front and right rear jacks or both rear jacks. In the manual mode, the jacks are controlled by the UP and DOWN arrow buttons on the right hand side of the touch panel. The UP arrows extend jack pairs and the DOWN arrows retract jack pairs.

There are two parts to leveling a vehicle. First the vehicle is leveled. The jacks are used to turn all the yellow level indicators off. The second part of leveling is to stabilize the vehicle. This is accomplished by extending any jacks not used for leveling to the ground and lifting the vehicle between 1/4 to 3/4 inch.

If the vehicle is equipped with an air suspension, the air must be exhausted from the suspension before leveling the vehicle. If the air is not exhausted, the suspension height control valves will interfere with the leveling procedure. There are two types of air dump systems that HWH controls. One system uses air solenoid valves supplied by HWH. The second system is supplied by the chassis manufacturer. This is a pilot air dump system. In the automatic mode, the air is dumped automatically before the leveling process is started. For manual leveling, the HWH touch panel has a "DUMP" button. The "DUMP" button will work if the ignition is on and the park brake is set. If the vehicle uses the HWH air dump valves, the "DUMP" button must be pushed and held until all of the air is exhausted from the vehicle suspension system. The engine must be off. If a pilot air dump system is used, the engine may be on or off. The "DUMP" button can be pushed and released. The pilot air dump system will return to the travel position if the ignition is on and the "STORE" button is pushed or the park brake is released.

NOTE: Releasing the park brake to return the suspension to travel mode (vehicle to ride height) is not recommended for normal operation. This is a fail safe if the "STORE" button is not used to retract the jacks.

PUMP PROTECTION: The HWH system has pump protection built into the control system. An up and down timer will turn the pump off and lock the system if a total of 3 minutes is reached. The master relay will not be on if this happens. Example: The pump runs for 1 minute and is off for 20 seconds. The pump must run 2 minutes and 20 seconds more without interruption to turn the pump off. Any "OFF" time adds more run time for the pump. This includes operation of HWH rooms. Turn the ignition off, push the "CANCEL" button or release the park brake to "UNLOCK" the system.

NOTE: The pump timer was changed to 4 minutes for systems with 3" pump motors and 6 minutes for systems with 3.7" or 4.5" pump motors. Contact HWH Corporation for assistance.

AUTOMATIC OPERATION

The ignition must be in the "ON" or "ACC." position and the park brake must be set to use the system. The "TRAVEL MODE" light will be on and one or two yellow level indicator lights may be on anytime the ignition is in the "ON" or "ACC" position. The park brake must be set for the yellow level lights to work. The "NOT IN PARK/ BRAKE" indicator light will come on while the "AUTO LEVEL" button is being pushed if the park brake signal is not present. The system will not function.

LEVELING: Push the "AUTO LEVEL" button one time. The AUTO LEVEL light will flash. If applicable, the air will dump for twenty five (25) seconds before the leveling procedure starts.

WARNING: IF THE VEHICLE IS EQUIPPED WITH A PILOT AIR DUMP FOR THE SUSPENSION AND A BUTTON IS PUSHED TO STOP THE AUTOMATIC LEVELING PROCESS, THE SUSPENSION WILL CONTINUE TO DUMP AIR. PUSHING THE "STORE" BUTTON OR RELEASING THE PARK BRAKE AFTER THE LEVELING PROCESS IS STOPPED WILL RETURN THE PILOT AIR DUMP TO THE TRAVEL POSITION, IF THE IGNITION IS ON.

NOTE: If the vehicle is equipped with remote leveling system rocker switches, pushing a rocker switch to "LEVEL" will start the automatic leveling process if the ignition is on and the park brake set. The rocker switch light will flash.

On the right hand side of the touch panel there are four (4) red and four (4) yellow indicator lights. The four red indicator lights are JACK DOWN warning lights. There is one light for each jack. These warning lights come on when their respective jacks are extended about 1/2 to 1 inch. The four yellow indicator lights are level indicators, front, left side, right side and rear. A lit yellow level light indicates that a side, end or corner (side and end light on) is low. When all four yellow level lights are out, the vehicle is level within the tolerance of the level sensing unit.

The computer will extend jack pairs according to the level lights starting with a lit side light. When all four level lights are out, the computer will extend any jacks not used for leveling to stabilize the vehicle.

725 TROUBLE SHOOTING GUIDE

AUTOMATIC OPERATIONS CONTINUED. . .

STABILIZING: Each jack has a pressure switch. When the jack pressure switch is on, the computer knows that jack is on the ground. Because of possible thermal contraction, it is important that all jacks have lifted the vehicle between 1/4 and 3/4 of an inch. This switch can be adjusted. The stabilizing mode has a specific sequence. The computer first checks the right rear jack pressure switch. If the right rear pressure switch is off, the computer extends the right rear jack until that pressure switch comes on. If the switch is on, or once the switch comes on, the computer then checks the left rear jack pressure switch. If the switch is off, the computer extends the left rear jack until its pressure switch comes on. If the pressure switch was on, or once the switch comes on, the computer rechecks the right rear jack, extending it if necessary. The computer then rechecks the left rear jack, extending it if necessary. After checking and rechecking the right rear then left rear jacks, the computer then checks both front jack pressure switches. If either pressure switch is off, the computer will run the pump and open both front jack solenoid valves. When the computer sees both front jack pressure switches the computer shuts the pump off and turns the solenoid valves off. If all yellow level lights are off, the system is now done.

LEVELING RECHECK: Because the coach can be "bumped" slightly during the stabilize procedure, a yellow level light can come on during stabilize. If a yellow light comes on during stabilize, when the stabilize procedure is finished, the computer will extend jack pairs as necessary to turn any lit yellow level lights off. After turning the level lights off, the computer will turn off no matter what position the jack pressure switches are in.

EXCESS SLOPE: Excess slope is when two jacks extend as far as they can without turning a yellow level light out. The pump will go to relief and trip a 3000# pressure switch on the leveling manifold. The "EXCESS SLOPE" light will come on. Jacks that have not been extended will not extend when the "EXCESS SLOPE" light is on. The "EXCESS SLOPE" light will be on whenever the ignition is on until the park brake is released (with the ignition on) or the jacks are completely retracted with the "STORE" button.

The "CANCEL" button will stop the automatic leveling process any time. After pushing the "AUTO LEVEL" button to start the automatic leveling process, pushing the "AUTO LEVEL" button again or pushing the "STORE" button will stop the automatic leveling process. If the vehicle is equipped with remote leveling system rocker switches, pushing the rocker switch to "LEVEL" or "STORE" will stop the automatic leveling process.

MANUAL OPERATION

The ignition must be in the "ON" or "ACC." position and the park brake must be set to use the system. The "NOT IN PARK/ BRAKE" indicator light will come on while pushing an UP or DOWN arrow manual button if the park brake signal is not present. The system will not function.

If applicable, use the DUMP button to dump the air before extending jacks. Air should be completely exhausted from the vehicle suspension before starting a leveling process.

On the right hand side of the touch panel there are four (4) red and four (4) yellow indicator lights. The four red indicator lights are JACK DOWN warning lights. There is one light for each jack. These warning lights come on when their respective jacks are extended about 1/2 to 1 inch. The four yellow indicator lights are level indicators, front, left side, right side and rear. A lit yellow level light indicates that a side, end or corner is low. When all four yellow level lights are out, the vehicle is level within the tolerance of the level sensing unit.

Use the UP ARROW (Extend jack pairs) and DOWN ARROW (Retract jack pairs) buttons to extend jack pairs as needed to level and stabilize the vehicle. Side level lights should be turned off before turning off front or rear level lights. Stabilizing should be done using the front and / or the rear UP ARROWS.

725 TROUBLE SHOOTING GUIDE

STORE MODE

The touch panel has a "STORE" button and light. The ignition must be in the "ON" or "ACC." position. The STORE light will come on when the "STORE" button is pushed. The front jacks will retract for five (5) seconds before the rear jacks start to retract. The STORE light will go out one (1) minute after the last of the four individual red WARNING lights go out. If the vehicle is equipped with an air suspension, the leveling system will return to the travel mode when the "STORE" button is pushed.

Pushing the "CANCEL", the "AUTO LEVEL" or "STORE" button after starting the automatic store procedure will halt the automatic store procedure.

NOTE: If the vehicle is equipped with remote leveling system rocker switches, pushing the rocker switch to STORE will start the automatic store procedure. Pushing the rocker switch either direction will halt the automatic store procedure.

The "STORE" button should always be used to retract the jacks. This allows the system to store any jack that extends due to thermal expansion of the hydraulic fluid while traveling. When traveling, if a jack extends enough to allow a jack warning switch to turn on, the processor will turn the appropriate solenoid valve on so the jack can retract. The master warning light and buzzer will NOT come on at this time. If thirty (30) seconds after the solenoid valve is turned on the warning switch is still on, the processor will turn the master warning light, the buzzer and the appropriate red WARNING light on the touch panel on. The solenoid valves will turn off.

IMPORTANT: When testing a leveling system, all four sets of UP and DOWN arrow buttons should be used to make sure the complete system operates correctly, including the red WARNING lights and the yellow LEVEL lights. If the system will not work in the manual mode it is very unlikely the system will function properly in the automatic mode.

WARNING: IF THE VEHICLE IS EQUIPPED WITH A PILOT AIR DUMP SYSTEM, THE SUSPENSION WILL DUMP AIR AND START TO DROP AS SOON AS AN AUTOMATIC LEVEL BUTTON OR ROCKER SWITCH IS PUSHED. ALTHOUGH THE AUTOMATIC LEVELING PROCEDURE WILL HALT WHEN AN "CANCEL", "STORE", "AUTO LEVEL" OR ROCKER SWITCH IS PUSHED, THE VEHICLE SUSPENSION WILL CONTINUE TO DROP.

725 TROUBLE SHOOTING STEPS

MANUAL OPERATION

NOTE: The following diagnostic functions are written in order of operation and should be checked in this order. Failure to do so may cause improper diagnoses of the problem(s) and increase the time needed to repair the system.

IMPORTANT: Due to painting techniques of chassis rails or components and the construction of the chassis's, it is possible to have grounding issues between frame rails. When voltage issues are addressed, it is important to check chassis grounds, positive voltage connections and battery condition to ensure a good DC voltage circuit for the vehicle. Problems with these items, especially the chassis grounds, will create voltage issues for the HWH equipment.

PART 1. TOUCH PANEL TO I/O MODULE COMMUNICATION CHECK.

Note: Only review this section as an educational aid or if directed to PART 1 from other diagnostic steps in this manual.

There should be communication between the touch panel and the I/O module anytime the ignition is in the ON or ACC. position. The touch panel and the I/O module each have a "Link Light". If both link lights are flashing, this indicates proper communication between the touch panel and I/O module. If either link light is off or on but not flashing, there is a communication problem. The link lights will flash with the park brake on or off but the ignition must be in the ON or ACC position.

CAN Information: Communication between the touch panel and I/O module is provided by a twisted pair of yellow and green wires. At each end of the harness there is a 120 ohm resistor connecting the two wires. These are called terminating resistors. The yellow wire is in pin A2 of the 32 pin I/O module connector and pin 1 of the 5 pin MTA touch panel connector. The green wire is in pin B2 of the 32 pin I/O module connector and pin 2 of the 5 pin MTA touch panel connector. When using an ohm meter to check the yellow and green communication wires, the meter should show 60 ohms, $\pm 10\%$ when checking between the two wires.

A. Neither link light is on, check the "TRAVEL MODE" light on the touch panel. If the "TRAVEL MODE" light is off, there may be no power to the touch panel or I/O module, go to PART 4, section B of the trouble shooting steps.

SEE: MP84.3170 and MP84.3334

B. If the "TRAVEL MODE" light is on or one link light is on or flashing, turn the ignition off. There must be no power to the I/O module for the following tests. Make sure the yellow and green wires are properly seated into the 32 pin and 5 pin connectors. If the wires and pins are properly seated, **check resistance between pins 1 and 2 at the 5 pin touch panel connector.** If there is proper resistance of 60 ohms ($\pm 10\%$) the problem is the I/O module or the touch panel. There is no good test to determine which is bad. The touch panel would be the easiest to try first. **SEE: MP84.3334**

Note: Although the resistance between the green and yellow wire is good, it may be possible that a wire may be shorted to another wire in the harness that affects communication but not the resistance of the terminating resistors. If the resistance shown with the touch panel and I/O module plugged in is ok, unplug both and check for continuity between the yellow then green wires and the other wires in the 32 pin connector. There should be no continuity.

If the ohm meter shows improper resistance, unplug the touch panel and check pins 1 and 2 of the harness connector. If the resistance is now ok, replace the touch panel. If the resistance is still incorrect, plug the touch panel back in and unplug the 32 pin I/O module connector. Check between pins A2 and B2 of the 32 pin harness connector. If the resistance is good, replace the I/O module. If the resistance is incorrect, there is a problem with the yellow and green communication wires. **SEE: MP84.3170**

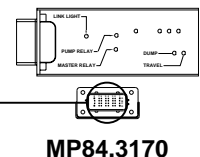
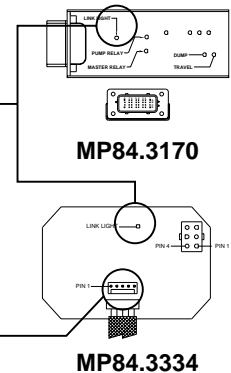

725 TROUBLE SHOOTING STEPS

MANUAL OPERATION

PART 2. WITH THE IGNITION OFF, THE HWH TOUCH PANEL SHOULD HAVE NO INDICATOR LIGHTS ON AND SHOULD NOT FUNCTION.

A. If the touch panel has any indicator lights on or will function with the ignition off, the red 6120 wire that is part of the touch panel harness is connected to a constant power source and should be moved to the ACC. side of the vehicle ignition switch. The red 6120 wire is on pin D1 of the 32 pin connector at the Multiplexed I/O Module. **SEE: MP84.3130**

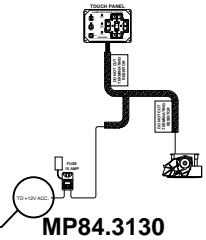

PART 3. THE PUMP RUNS ANY TIME THE IGNITION IS ON. If the pump runs with the ignition on, proceed to PART 4.A.

PART 4. WITH THE IGNITION ON, THE PARK BRAKE SET AND ALL JACKS FULLY RETRACTED, THE "TRAVEL MODE" LIGHT ON THE TOUCH PANEL SHOULD BE ON. NO RED WARNING LIGHTS ON THE TOUCH PANEL SHOULD BE ON. THE MASTER "JACKS DOWN" WARNING LIGHT AND BUZZER SHOULD NOT BE ON. ONE OR TWO YELLOW LEVEL INDICATOR LIGHTS MAY BE ON BUT NOT OPPOSING LEVEL INDICATOR LIGHTS.

Important: You should not allow the pump to run under a load for more than four (4) minutes without allowing the pump motor to cool. If the pump motor is extremely hot to the touch, allow the motor to cool.

A. The pump starts to run when the ignition is turned on. Check the red pump LED on the I/O module: **SEE: MP84.3170**

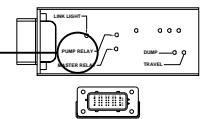

1. **The pump LED is off.** Turn the ignition off and remove wire 8600 from terminal #6 of the pump relay. Turn the ignition back on. If the pump runs, the relay is stuck and has to be replaced. If the pump does not run, touch the 8600 wire to terminal #6. (The red pump LED could be burnt out.) If the pump does not run, the problem was a stuck relay and the relay should be replaced. (Bumping a relay, such as removing the 8600 wire, could cause the relay contacts to open.) If the pump starts to run, the problem is the touch panel or the I/O module. (Either way, replace the I/O module because the pump LED is burnt out.) Unplug the touch panel and with the ignition on, touch the 8600 wire to terminal #6. If the pump runs, the problem is the I/O module. If the pump does not run, the problem is the touch panel or I/O module. **SEE: MP84.3240**

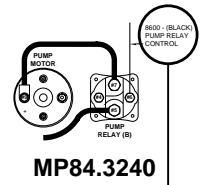

2. **The pump led is on.** NOTE: If the vehicle is equipped with HWH rooms, unplug the pump request wire coming from the 32 pin I/O module connector. If now the pump does not run, the problem is with the room controls or wiring. Contact HWH Corporation for assistance. Turn the ignition off and unplug the touch panel. Turn the ignition on. If the pump runs, the problem is the I/O module. If the pump does not run, the I/O module or touch panel could be the problem.

B. The "TRAVEL MODE" light is not on, none of the four (4) individual red warning lights are on. If any other touch panel light is on, replace the touch panel. If no other touch panel lights are on, push the "STORE" button. The STORE light should start to flash.

1. **The STORE light starts to flash or any other touch panel light comes on.** Replace the touch panel.

2. **The STORE light does not flash and no touch panel light comes on.** There may be no power or ground to the touch panel. Check the link light on the back of the touch panel. If the link light is on or blinking, replace the touch panel. If the link light is off, check for +12 volts between pins 4 and 5 of the five (5) pin MTA connector at the touch panel. **SEE: MP84.3334**

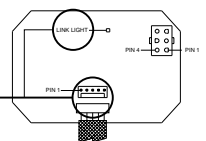

If there is power between pins 4 and 5, replace the touch panel.

If there is no power, check pin 5 to a known good ground. If there is power on pin 5 to ground, there is a problem with the white 6230 ground wire from the I/O module. Unplug the 32 pin connector at the I/O module. Check pin B3 of the I/O module plug for ground. **SEE: MP84.3170**

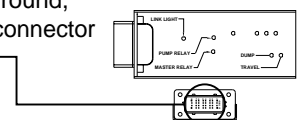

725 TROUBLE SHOOTING STEPS

MANUAL OPERATION

PART 4. SECTION B.2. CONTINUED

If there is a ground on pin B3, the white 6230 wire in the harness to the touch panel or at one of harness connectors has a problem. After repairing the problem with the 6230 wire, make sure the "TRAVEL MODE" light comes on. If it does not come on, start at the beginning of section B again.

If there is no ground on pin B3, check the white 14 gauge ground wire coming from the top of the I/O module. This ground wire goes to a ground connection on the side of the pump. Check this connection and the pump mounting or a grounding cable if used. If the grounds for the pump and I/O module are ok, replace the I/O module. SEE: MP84.3240

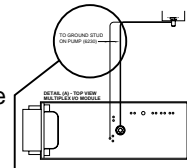

MP84.3240

If there is no power on pin 5 at the touch panel, unplug the 32 pin connector at the I/O module and check pin D1 in the harness plug for +12 volts. (If the link light on the I/O module is on or blinking, there is power on pin D1 in the harness plug.) SEE: MP84.3170

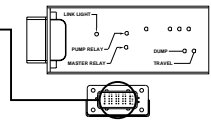

MP84.3170

If voltage is not present on pin D1, the problem is the red 6120 wire, its power source or its connection to the harness plug. Check any fuse for the 6120 wire. If a fuse is blown, replace the fuse, plug the harness back into the I/O module and recheck the touch panel. If the fuse continues to blow, the 6120 wire or the 6800 wire in the harness could be shorted to ground. If neither wire is shorted, the I/O module or the touch panel could be the problem. Unplug the 32 pin connector at the I/O module and unplug the touch panel. At the 32 pin connector, check that pin B1 (6800 wire) and D1 (6120 wire) have no continuity to any other pin in the connector or to ground. Repair as necessary. If the harness is ok, plug the 32 pin connector back in and replace the fuse (leave the touch panel unplugged). If the fuse blows, replace the I/O module. If the fuse does not blow, plug the touch panel in and replace the fuse. If the fuse blows, replace the touch panel. If the fuse does not blow, continue.

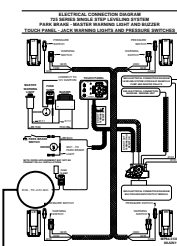

MP84.3130

If the fuse for the 6120 wire is good, use a meter or test light to check the power source for the 6120 wire. If there is no power at the source, this must be repaired. Contact the vehicle manufacturer for assistance with locating the power source for the 6120 wire. SEE: MP84.3130

If voltage is present on pin D1 of the harness connector, check for continuity between pins B1 and D1 of the 32 pin I/O module connector (not the harness plug). If there is no continuity, replace the I/O module. If there is continuity, there is a problem with the red 6800 wire in the harness, with its connection to the I/O module or its connection to the 5 pin MTA connector at the touch panel. SEE: MP84.3170

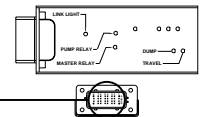

MP84.3170

If the "TRAVEL MODE" light is still not on, review PART 4 section B again.

C. The "TRAVEL MODE" light is NOT on. A red warning light on the touch panel is on. All Jacks are fully retracted. The ignition is on and the park brake is set. Unplug the warning switch for the jack that has a lit warning light. SEE: MP84.3130

NOTE: If more than one warning light is on, address each one individually.

If the warning light goes out, either the warning switch is bad or the magnet in the jack is bad. With the warning switch removed from the jack, there should be continuity between the two switch wires. If a magnet is held to the bottom of the switch, there should be no continuity between the two wires. If the warning switch is good, the jack cylinder will have to be replaced.

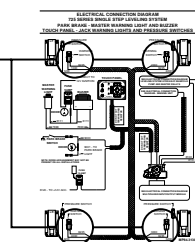

MP84.3130

725 TROUBLE SHOOTING STEPS

MANUAL OPERATION

PART 4. SECTION C. CONTINUED

If the warning light does not go out, unplug the 32 pin connector at the I/O module. Check for continuity between the signal wire for the warning switch and the ground wire for the warning switches on pin D2. If there is continuity, the wires are shorted and need to be repaired. If there is no continuity between the warning switch signal wire and the ground wire on pin D2, check for continuity between the warning switch signal wire and chassis ground. If there is continuity to ground, the warning switch signal wire is shorted to ground and must be repaired. If there is no continuity to ground, check and record the voltage between pin D1 of the 32 pin harness connector and the brass ground stud on the top of the I/O module. Plug the 32 pin connector back in. Check the voltage between the ground and signal wire in the warning switch plug. The voltage should be within less than 1 volt of the voltage you recorded on pin D1 of the harness connector. If the voltage is good, replace the touch panel. If there is a difference in the voltage greater than 1 volt, the I/O module needs to be replaced. **SEE: MP84.3170**

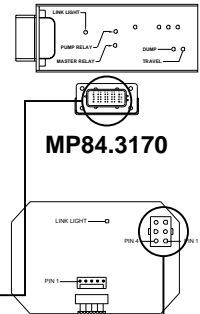

D. The master warning light and buzzer are on along with the "TRAVEL MODE" light. Power for the master warning light and buzzer come from the ON side of the ignition switch. The control signal for the master warning light and buzzer is a switched ground on the black wire 7699 that comes from the 6 pin UML connector on the touch panel. **SEE: MP84.3334 and MP84.9964**

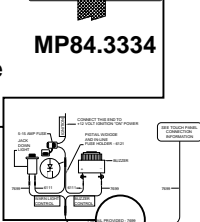

Unplug the 6 pin UML connector from the touch panel. If the light and buzzer go out, replace the touch panel. If the light and buzzer remain on, the 7699 wire is shorted to ground and must be fixed.

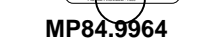

E. Opposing yellow level indicator lights on the touch panel are on. Check the link light on the back of the touch panel. If the link light is off or on steady, replace the touch panel. If the link light is flashing, check the four yellow LEDs on the bottom of the sensing unit. If opposing LEDs are on, replace the sensing unit. If only one LED or no LEDs are on, **unplug the sensing unit from the harness.** **SEE: MP84.3430**

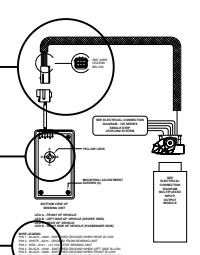

1. The yellow level indicator lights on the touch panel all go out. Use a test light connected to a good ground to check the four pins that are connected to the signal wires. **SEE: MP84.3430** Touch one pin at a time with the test light. Check that the appropriate touch panel level light comes on. If the touch panel lights work properly, replace the sensing unit. If the touch panel lights do not work properly when grounding the harness pins, unplug the 32 pin connector at the I/O module and leave the sensing unit unplugged. There should be no continuity between the four signal wire pins, C4, C8, D6 and D7. If necessary, repair any problems with the harness. If the harness checks out OK, the problem is the I/O module or touch panel. **SEE: MP84.3170**

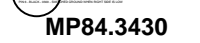

2. One or more yellow indicator lights on the touch panel remain on. Unplug the 32 pin connector at the I/O module and leave the sensing unit unplugged. There should be no continuity between pins C4, C8, D6 and D7 (sensing unit signal wires) of the 32 pin harness connector and any other pin in the connector. There should be no continuity between the four signal wire pins, C4, C8, D6 and D7. There should be no continuity between the four signal wire pins and chassis ground. If necessary, repair any problems with the harness. If the harness checks out OK, plug the 32 pin connector back into the I/O module. **SEE: MP84.3170**

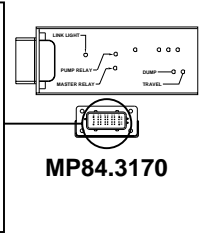

At the six pin sensing unit harness plug, using a volt meter, check and record the voltage between the ground and power wire in the plug. **SEE: MP84.3430**

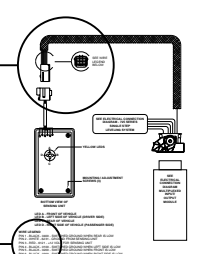

Now check between the ground wire and each of the four signal wires in the plug. The voltage between the ground wire and a signal wire should be within less than 1 volt of the recorded voltage. If the voltage reading on the four signal wires is OK, replace the touch panel. If the voltage on any signal wire is not within less than 1 volt of the recorded voltage, replace the I/O module.

F. The "NOT IN PARK/BRAKE" light is on. If the "NOT IN PARK/BRAKE" light is on and no touch panel button is being pushed, replace the touch panel.

725 TROUBLE SHOOTING STEPS

MANUAL OPERATION

PART 5. PARK BRAKE CHECK. The system will not function if the park brake is not set. It is also important that the park brake circuit is functioning properly and that the system cannot function with the park brake released.

WARNING: CHOCK THE VEHICLE WHEELS BEFORE RELEASING THE PARK BRAKE. THE VEHICLE CAN ROLL FORWARD OR BACKWARD CAUSING INJURY OR DEATH.

A. With the ignition in the ON or ACC. position and the park brake set, push any DOWN arrow on the touch panel. The "NOT IN PARK/BRAKE" light should not come on. Release the park brake and push any DOWN arrow on the touch panel. The "NOT IN PARK/BRAKE" light should come on. Reset the park brake.

1. With the park brake set, the "NOT IN PARK/BRAKE" light comes on while pushing a DOWN arrow. There should be a ground on the park brake wire (9000) with the park brake set. Unplug the 32 pin connector at the I/O module. The black #9000 park brake wire is on pin D8. Use a test light connected to a +12 source such as the battery supply side of the master relay to check pin D8 for a ground. **SEE: MP84.3170**

If there is no ground on pin D8 of the harness connector, the problem is the #9000 wire, the wire connection to the 32 pin connector, the connection of the #9000 wire to the park brake switch out put or something is wrong with the park brake switch. **SEE: MP84.3130**

NOTE: Contact the vehicle manufacturer for information concerning the park brake switch or the connection of the HWH 9000 wire to the park brake switch.

If there is a ground on pin D8 of the harness connector, make sure the #9000 wire is properly inserted into the connector. Give the wire a light pull. If the wire is loose in the connector, the pin may not have good contact with the module pin. Check for any corrosion problems. If the wire and pin are properly inserted into the 32 pin connector and the pin or socket are not corroded, use a voltmeter to check voltage between the white and red wire in the 5 pin MTA connector on the back of the touch panel. **If there is less than 10.5 volts at the touch panel,** voltage to the I/O module should be checked. Ign./Acc. voltage to the I/O module is on pin D1 in the 32 pin connector at the I/O module. Ground for the I/O module (and touch panel) is a 14 gauge wire coming out of the top of the I/O module, not the brass ground stud on the module. If voltage to the module is low, check all ground connections and the voltage source. If voltage to the module is good but there is low voltage coming from the module to the touch panel, make sure all connections for the red 6800 wire on pin B1 and white 6230 wire on pin B3 are good. If all wires and connections are good, replace the I/O module. **If voltage at the touch panel is good, replace the I/O module. SEE: MP84.3170 and MP84.3334**

2. With the park brake released, the "NOT IN PARK/BRAKE" light does not come on when a DOWN arrow is pushed. Push any UP arrow. If the "NOT IN PARK/BRAKE" light is not coming on, the pump should run.

IF THE PUMP RUNS with the park brake released, either the #9000 park brake wire has a ground on it or the I/O module is bad.

Unplug the 32 pin connector at the I/O module. The black #9000 park brake wire is on pin D8. Make sure the park brake is released. Use a test light connected to a +12 source such as the battery supply side of the master relay to check pin D8 for a ground. **SEE: MP84.3170 and MP84.3130**

If there is a ground on pin D8, the #9000 park brake wire is shorted to ground, improperly connected or there is a problem with the park brake switch.

If there is no ground on pin D8 of the harness connector, there is a problem with the I/O module and it should be replaced.

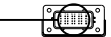
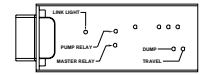

MP84.3170

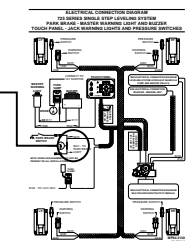

MP84.3130

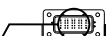
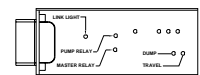

MP84.3170

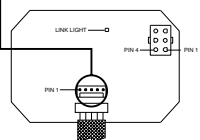

MP84.3334

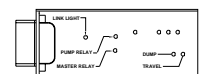

MP84.3170

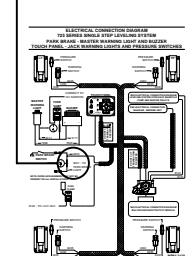

MP84.3130

725 TROUBLE SHOOTING STEPS

MANUAL OPERATION

PART 5. SECTION A.2. CONTINUED

IF THE PUMP DOES NOT RUN when pushing an up arrow with the park brake released, set the park brake and push any UP arrow. If the pump runs with the park brake set, the problem is the touch panel. If the pump does not run with the park brake set, the problem is the touch panel, the I/O module, a communication problem or a voltage issue.

Check the link light on the back of the touch panel and on the I/O module.

Both lights should be flashing. If either light is off or on steady, go to PART 1, "TOUCH PANEL TO I/O MODULE COMMUNICATION CHECK".

SEE: MP84.3334 and MP84.3170

If both link lights are flashing, the next step is checking voltage. Use a voltmeter to check voltage between the white and red wire in the 5 pin MTA connector on the back of the touch panel. **If there is less than 10.5 volts at the touch panel,** voltage to the I/O module should be checked. Ign./Acc. voltage to the I/O module is on pin D1 in the 32 pin connector at the I/O module. Ground for the I/O module (and touch panel) is a 14 gauge wire coming out of the top of the I/O module, not the brass ground stud on the module. If voltage to the module is low, check all ground connections and the voltage source. If voltage to the module is good but there is low voltage coming from the module to the touch panel, make sure all connections for the red 6800 wire on pin B1 and white 6230 wire on pin B3 are good. If all wires and connections are good, replace the I/O module. **SEE: MP84.3334 and MP84.3170**

If voltage at the touch panel is good, unplug the 32 pin harness connector at the I/O module. Check and record the voltage between pin D1 of the 32 pin harness connector and the brass ground stud on the top of the I/O module. Plug the 32 pin connector back in. Disconnect the #9000 park brake wire from the park brake switch connection. Make sure there is no ground on the #9000 park brake wire. Check the voltage between the #9000 wire, pin D8 of the 32 pin connector, (close to the I/O module) and the brass ground stud on the top of the I/O module. Strip some insulation from the wire close to the connector. Make sure to repair the wire with some type of sealant when the test is finished. The voltage should be within less than 1 volt of the voltage you recorded on pin D1 of the harness connector. If there is a difference in the voltage greater than 1 volt, the I/O module needs to be replaced. If the voltage is good, the problem is the I/O module or touch panel. Replace the touch panel first. If the problem remains, reinstall the original touch panel and replace the I/O module.

SEE: MP84.3170

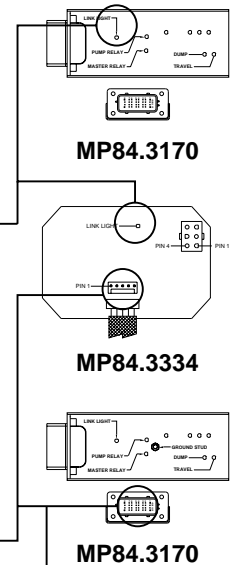

MANUAL SYSTEM OPERATION

PART 6. FOR VEHICLES EQUIPPED WITH AIR SUSPENSION

The two types of suspension air dump, pilot air dump or HWH air dump valves, are explained in the **SYSTEM OPERATION** and **GLOSSARY** sections of this manual. The ignition must be in the "ON" or "ACC" position and the park brake must be set for the air dump system to function. The vehicle should be at ride height with all air bags full of air when checking air dump.

A. PILOT AIR DUMP: The air should start to dump when the "dump" button is pushed and continue to dump when the "dump" button is released. If the ignition is on and the "store" button is pushed or the park brake is released, the vehicle should return to ride height if there is ample air in the suspension air tanks.

725 TROUBLE SHOOTING STEPS

MANUAL SYSTEM OPERATION

PART 6. SECTION A. CONTINUED

1. THE AIR DOES NOT START TO DUMP WHEN THE "DUMP" BUTTON IS PUSHED.

Make sure the ignition is on and the park brake is set. Push any UP arrow. The pump should start to run. If the pump does not run, proceed to PART 7 Section B. If the pump runs, communication between the touch panel and the I/O module is ok, the master relay is on and there is output voltage to the I/O module. Check the red LED for dump on the I/O module while the "DUMP" button is being pushed. This LED should be on. **SEE: MP84.3170**

The DUMP LED is on while pushing the DUMP button, air will not dump from the suspension.

Unplug the 3 pin Packard connector at the I/O module and check for voltage between the white ground wire in pin A and the 9300 dump wire in pin B. If there is no voltage, make sure the wire to pin connections for both wires are ok. Fix if necessary. If the connections are ok, replace the I/O board. If there is voltage between the white wire and the 9300 wire, plug the connector back in and locate the 4 pin UML connector and check for voltage between the white wire in pin 3 and the 9300 dump wire in pin 1. If there is good voltage (10 volt or more) at the 4 pin UML connector, with the connector plugged in, the problem is with the suspension dump equipment, contact the vehicle manufacturer. If there is no voltage at the 4 pin UML connector, the problem is with the connections or harness wires between the 3 pin Packard connector and the 4 pin UML connector. **SEE: MP84.3170 and MP84.3135**

The DUMP LED is not on while pushing the DUMP button. Unplug the 3 pin Packard connector at the I/O module. Turn the ignition off. Unplug the 32 pin harness connector at the I/O module. Wait about 10 - 15 seconds and plug the 32 pin connector back in. Turn the ignition on. Check the dump LED while pushing the DUMP button. If the LED is still off, the problem is most likely the I/O module but could be the touch panel. If the LED is now on, find the 4 pin UML plug and unplug it. Plug the 3 pin Packard connector back in. Check the dump LED while pushing the DUMP button. If the LED is off or goes out, there is a short to ground on the 9300 dump wire in the harness between the 3 pin Packard connector and the 4 pin UML connector. If the LED stays on, plug the 4 pin UML connector back in and check the dump LED while pushing the DUMP button. If the LED does not come on, goes out while pushing the DUMP button or will still not dump air, the problem is the chassis harness or the pilot dump valve. Contact the vehicle manufacturer for assistance. **SEE: MP84.3135 and MP84.3245**

2. THE SYSTEM STARTS TO DUMP AIR FROM THE SUSPENSION BUT STOPS DUMPING AIR WHEN THE "DUMP" BUTTON IS RELEASED.

Make sure the vehicle has a pilot air dump system and not a dump system that uses HWH air dump valves. Check the travel LED on the I/O module. If it is on after releasing the DUMP button, replace the I/O module. If the travel LED is not on, there is an issue with the air dump equipment. Contact the vehicle manufacturer. **SEE: MP84.3170**

3. THE VEHICLE SUSPENSION WILL NOT RETURN TO RIDE HEIGHT WHEN THE "STORE" BUTTON IS PUSHED AND THE IGNITION IS ON.

Make sure the suspension air tanks are full. Push any UP arrow. The pump should start to run. If the pump does not run, proceed to PART 7 Section B. If the pump runs, communication between the touch panel and the I/O module is ok, the master relay is on and there is output voltage to the I/O module. Check the travel LED on the I/O module, it should be on. The dump LED should be off. **SEE: MP84.3170**

The TRAVEL LED is on. Unplug the 3 pin Packard connector at the I/O module and check for voltage between the white ground wire in pin A and the 9301 dump wire in pin C. If there is no voltage, make sure the wire to pin connections for both wires are ok. Fix if necessary. If the connections are ok, replace the I/O board. If there is voltage between the white wire and the 9301 wire, plug the connector back in and locate the 4 pin UML connector and check for voltage between the white wire in pin 3 and the 9301 dump wire in pin 2. **SEE: MP84.3135 and MP84.3245**

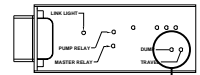

MP84.3170

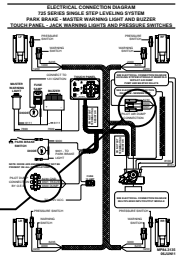

MP84.3135

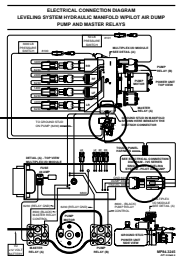

MP84.3245

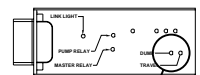

MP84.3170

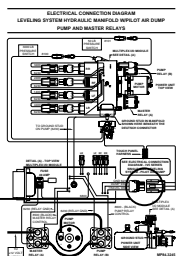

MP84.3245

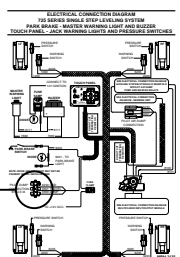

MP84.3135

725 TROUBLE SHOOTING STEPS

MANUAL SYSTEM OPERATION

PART 6. SECTION A.3 CONTINUED

If there is no voltage at the 4 pin UML connector, the problem is with the connections or harness wires between the 3 pin Packard connector and the 4 pin UML connector. **SEE: MP84.3135**

If there is good voltage (10 volt or more) at the 4 pin UML connector, with the connector plugged in, the problem is with the suspension dump equipment, contact the vehicle manufacturer.

SEE: MP84.3135

The TRAVEL LED is not on after pushing the STORE button. The STORE light above the STORE button should flash after the STORE button is pushed. If the light does not flash, replace the touch panel. If the light does flash after pushing the STORE button, unplug the 3 pin Packard connector at the I/O module. Turn the ignition off. Unplug the 32 pin harness connector at the I/O module. Wait about 10 - 15 seconds and plug the 32 pin connector back in. Turn the ignition on. Check the travel LED after pushing the STORE button. If the LED is still off, replace the I/O module. If the travel LED is now on, find the 4 pin UML plug and unplug it. Plug the 3 pin Packard connector back in. Check the travel LED. If the LED is off or goes out, there is a short to ground on the 9301 travel wire in the harness between the 3 pin Packard connector and the 4 pin UML connector. If the LED stays on, plug the 4 pin UML connector back in and check the travel LED. If the LED goes out, the problem is the chassis harness or the pilot dump valve. Contact the vehicle manufacturer for assistance.

SEE: MP84.3170 and MP84.3135

4. THE VEHICLE SUSPENSION WILL NOT RETURN TO RIDE HEIGHT WHEN THE PARK BRAKE IS RELEASED AND THE IGNITION IS ON. Make sure the suspension air tanks are full. **CHOCK THE VEHICLE WHEELS SO THE VEHICLE CANNOT ROLL.** Release the park brake. (Push any DOWN arrow. Make sure the "NOT IN PARK/BRAKE" touch panel light is on while pushing a DOWN arrow. If the "NOT IN PARK/BRAKE" light does not come on, review **PART 5 Section A2** of this repair manual.) Check the travel LED on the I/O module. If the LED is on, review PART 3 of this section. If the travel LED is not on, replace the touch panel.

B. HWH AIR DUMP VALVES: This section is for systems that incorporate hwh normally closed air dump valves to provide a suspension air dump system. When the "dump" button is pushed, air should exhaust from the vehicle suspension. If the "dump" button is released, the air will stop exhausting from the suspension. If there is adequate air in the suspension air tanks, the vehicle will start to return to ride height. *Vehicles with hwh air dump valves can go to ride height anytime there is air in the suspension air tanks.*

WARNING: DO NOT CRAWL UNDER THE VEHICLE UNLESS THE FRAME OF THE VEHICLE IS PROPERLY SUPPORTED. THE VEHICLE WILL DROP RAPIDLY WHEN AIR IS RELEASED FROM THE SUSPENSION CAUSING SEVERE INJURY OR DEATH.

1. WHILE PUSHING THE "DUMP" BUTTON, THE AIR WILL DUMP FROM AT LEAST ONE VALVE BUT NOT ALL OF THE DUMP VALVES. Locate the HWH air dump valves that are not working. Make sure the exhaust port of the valve is not plugged with dirt or debris. There is only one output for all the HWH dump valves from the I/O board. If not all of the valves are dumping air, there is a problem with the wiring harness to the valve(s) not working or a problem with the valve(s). Check for voltage to the valve(s) not working. If there is good voltage between the white and black wire in the harness to the valve, replace the valve. If there is no voltage to the valve, the problem is in the harness.

2. THE AIR DOES NOT START TO DUMP WHEN THE "DUMP" BUTTON IS PUSHED. Push any UP arrow. The pump should start to run. If the pump does not run, proceed to PART 7 Section B. If the pump runs, communication between the touch panel and the I/O module is ok, the master relay is on and there is output voltage to the I/O module. Check the red LED for dump on the I/O module while the "DUMP" button is being pushed. This LED should be on. **SEE: MP84.3170**

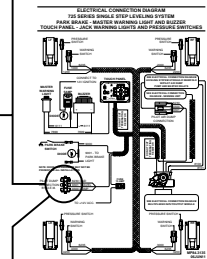

MP84.3135

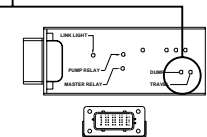

MP84.3170

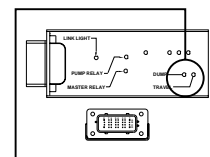

MP84.3170

725 TROUBLE SHOOTING STEPS

MANUAL SYSTEM OPERATION

PART 6. SECTION B.3. CONTINUED

The DUMP LED is on while pushing the DUMP button, air will not dump from the suspension. Unplug the 3 pin Packard connector at the I/O module and check for voltage between the white ground wire in pin A and the 9300 dump wire in pin B. If there is no voltage, make sure the wire to the pin connections for both wires are ok. Fix if necessary. If the connections are ok, replace the I/O board. If there is voltage between the white wire and the 9300 wire, plug the connector back in and locate the HWH air dump valves. Check for voltage between the white wire and the 9300 dump wire at the dump valve. If there is good voltage (10 volt or more) at the 4 pin UML connector, with the connector plugged in, the problem is with the suspension dump equipment, contact the vehicle manufacturer. If there is no voltage at the 4 pin UML connector, the problem is with the connections or harness wires between the 3 pin Packard connector and the 4 pin UML connector.

SEE: MP843135

The DUMP LED is not on while pushing the DUMP button. Unplug the 3 pin Packard connector at the I/O module. Turn the ignition off. Unplug the 32 pin harness connector at the I/O module. Wait about 10 - 15 seconds and plug the 32 pin connector back in. Turn the ignition on. Check the dump LED while pushing the DUMP button. If the LED is still off, the problem is most likely the I/O module but could be the touch panel. If the LED is now on, there is a short in the harness to the HWH dump valves or one or more HWH air dump valves are bad. Locate and unplug all HWH air dump valves. Plug the 3 pin Packard connector back in. Check the dump LED while pushing the DUMP button. If the LED is off or goes out, there is a short to ground on the 9300 dump wire in the harness between the 3 pin Packard connector and the HWH air dump valves. If the LED stays on, one or more of the HWH valves is bad. Plug one valve at a time back in. Check the dump LED while pushing the DUMP button. If the dump LED stays on, the valve is good. If the light does not come on or goes out, replace the valve. If the dump LED goes out while checking a valve, unplug the bad valve, turn the ignition off, and wait about a half minute before turning the ignition on and testing another valve.

SEE: MP84.3135 and MP84.3170

3. THE VEHICLE WILL NOT RETURN TO RIDE HEIGHT. Start the vehicle engine and make sure there is adequate air in the suspension air tanks. Any time the suspension air tanks are full the vehicle should return to ride height. There should be no air coming from the HWH air dump valves. If there is no air exhausting from the HWH dump valves, there is a problem with the vehicle suspension. Contact the vehicle manufacturer for assistance. If only one valve is exhausting air, replace the valve. If all the valves are exhausting air, check the dump LED on the I/O module. **SEE: MP84.3170**

If the LED is on, unplug the 3 pin Packard connector at the I/O module. **If the LED stays on,** unplug the touch panel. If the LED goes out with the touch panel unplugged, replace the touch panel. If the LED remains on, replace the I/O module. **If the LED goes out with the 3 pin Packard connector unplugged,** +12 volts is shorted to the 9300 dump wire in the harness. Correct this problem.

If the LED is off, all the dump valves must be stuck open and need to be replaced.

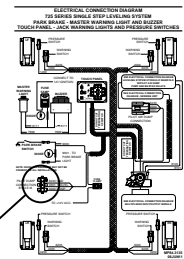

MP84.3135

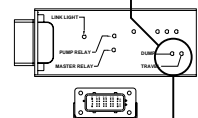

MP84.3170

PART 7. MANUAL OPERATION OF THE JACKS. The jacks can be manually operated when the ignition is on and the park brake is set. Each set of UP and DOWN arrows on the manual side of the touch panel control two jacks; both front, both rear, the left front and left rear or the right front and the right rear. The UP arrows extend the jacks and lift the vehicle. The DOWN arrows retract the jacks and lower the vehicle. The pump should only run when an UP arrow is pushed. When a jack extends between 1/2 inch and 1 inch, the red warning light for that jack will come on and the "TRAVEL MODE" light will go out. If the ignition is in the ON position, the master "JACKS DOWN" warning light and the warning buzzer will also come on. Some systems are wired so the master warning light will come on if the ignition is in the ACC. position but the buzzer will come on only if the ignition is in the ON position.

725 TROUBLE SHOOTING STEPS

MANUAL SYSTEM OPERATION

PART 7. CONTINUED

NOTE: The master relay should be on anytime the ignition is on even if the park brake is not set. The ignition must be on (or in ACC.) with the park brake set for the pump relay to function.

PUSH AND HOLD AN UP ARROW. The pump should run and the appropriate jacks should extend. The red warning lights for the jacks should come on. Extend the jacks far enough to lift the vehicle.

PUSH AND HOLD THE CORRESPONDING DOWN ARROW. The jacks should retract fully and the jack down warning lights on the touch panel should go out. Repeat this with all sets of UP and DOWN arrows. If the jacks will not retract during the test, proceed to PART 7b.

PART 7a. EXTENDING JACKS WITH UP ARROW BUTTONS

A. THE PUMP WILL NOT RUN WHEN ANY UP ARROW BUTTON IS PUSHED. THE "NOT IN PARK/BRAKE" LIGHT ON THE TOUCH PANEL IS COMING ON WHILE THE UP ARROW BUTTON IS BEING PUSHED. Check that the vehicle ignition is on and the park brake is set.

If the park brake is set, check that the #9000 wire is properly connected to the vehicle park brake circuit. **SEE: MP84.3130** Consult the vehicle manufacturer for park brake wiring information. The #9000 wire should have a ground when the park brake is set. With the park brake set, unplug the 32 pin connector at the I/O module and check pin D8 in the harness plug. **If a ground is present,** make sure the 9000 wire is securely seated into the 32 pin harness connector. Replace the I/O module if the wire is OK. **If a ground is not present,** the problem is the pin connection to the the #9000 wire, the #9000 wire, the connection for the #9000 wire to the park brake circuit or the park brake circuit or switch. **SEE: MP84.3170**

B. THE PUMP WILL NOT RUN WHEN ANY UP ARROW BUTTON IS PUSHED. THE "NOT IN PARK/BRAKE" LIGHT IS NOT COMING ON. Make sure the ignition is on and the park brake is set. There are red LEDs on the I/O module for the master and pump relays. The master relay LED should be on any time the ignition is on. Both LEDs should be on when an UP arrow button is pushed. **SEE: MP84.3170**

1. The red master relay LED is NOT on. There must be power and ground to the touch panel and the I/O module along with proper communication between the two. If you are following the repair steps in order, this has been checked. If not, make sure the ignition is in the ON or ACC. position. Check the "TRAVEL MODE" light on the touch panel. If the light is not on, go to PART 3. Section B of the repair steps. If the "TRAVEL MODE" light is on, check the link lights on the I/O module and the touch panel. They should be flashing. If either light is not on or is on steady, review PART 1. If power and communication is ok, there may be a short to ground on the (#2) 8500 master relay control wire or the master relay coil may have a short to ground. **SEE: MP84.3240**

Turn the ignition off and remove the 8500 wire from the master relay. Check the 8500 wire for a short to ground. The wire is only about a foot long. Fix if necessary. Make sure the 8500 wire ring terminal is isolated from ground. Turn the ignition back on. If the master relay LED does not come on, replace the I/O module. If the LED does come on, turn the ignition off and reattach the 8500 wire to the master relay. Turn the ignition on. If the master relay LED does not come on or goes out after a short period of time, replace the master relay. Retry any UP arrow. If the pump now runs, continue testing the system according to PART 7. If the pump still does not run, check the pump LED while pushing an UP arrow. If the pump LED is not on, proceed to SECTION B.2. If the pump LED is on and the pump will not run, proceed to SECTION B.3.

2. The master relay LED is on but the pump LED is not on while pushing an UP arrow. Use a test light or volt meter to check terminals 1, 2 and 3 of the master relay for +12 volts. Terminal 4 of the master relay must be a good ground and should be the grounding point for your test light or meter. Make sure relay connections are clean, free of corrosion and tight. Corrosion in the connection can be present even though the connection "looks" good. **SEE: MP84.3240 and MP84.3520**

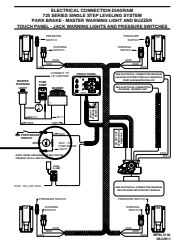

MP84.3130

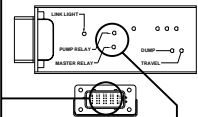

MP84.3170

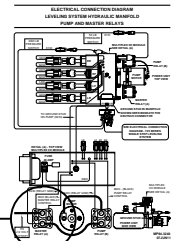

MP84.3240

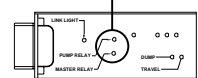

MP84.3170

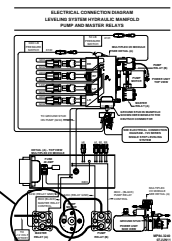

MP84.3240
and
MP84.3520

725 TROUBLE SHOOTING STEPS

MANUAL SYSTEM OPERATION

PART 7a. SECTION B.2. CONTINUED

If there is no voltage on terminal 1 (+12 battery), there is a problem with the cable, connections or +12 volt supply. With the master relay LED on, there should be voltage on terminal 2 of the master relay. If there is no voltage on terminal 2, check the master relay control wire (8500), the ring terminal and terminal connection to the relay. **SEE: MP84.3240**

If everything with the wire and connection is ok and there is no voltage on the wire with the master relay LED on, replace the I/O module. **SEE: MP84.3240**

Note: If you are using terminal 4 for a ground connection, remember to make sure terminal 4 has a good ground connection. If terminals 1 and 2 have no voltage, check terminal 1 to a good frame ground. If terminal 1 does have voltage, there is a problem with the ground connection for terminal 4. Check the pump mounting and the system ground connection.

If terminals 1 and 2 of the master relay have power, check terminal 3. If terminal 3 has no power, low voltage could be an issue. **SEE: MP84.3240** For the relay to turn on, there must be at least 8 volts between terminals 2 and 4 while pushing an UP arrow. If the voltage is low, PART 3 section B explains how to check voltage. This section is used to check when there is no voltage but can be used to track down a low voltage issue. If voltage between terminals 2 and 3 is adequate, replace the master relay. **SEE: MP84.3240**

If terminal 3 has power, check the 40 amp fuse in the #10 wire going from terminal 3 to the I/O module. If the fuse is blown, the I/O module will have to be replaced. If the 40 amp fuse is blown, check each solenoid valve to make sure none have a direct short to ground. If the fuse is ok, check the ring terminal and the ring terminal connection to terminal 3 of the master relay. If the wire, ring terminal, fuse and connection to terminal 3 are ok, the problem is the I/O module or a short to ground on the 8600 pump relay wire or the coil of the pump relay. **SEE: MP84.3240**

Turn the ignition off. Remove wire 8600 from terminal 6 of the pump relay. Make sure the 8600 wire ring terminal is isolated from ground. Wait a minute or two and turn the ignition back on. Check the pump LED while pushing an UP arrow. If the pump LED still does not come on or goes out after a few moments, make sure the 8600 wire is not shorted to ground. If it is, repair it. If the wire is ok, replace the I/O module. If the pump LED stays on, release the UP arrow, then re-attach the 8600 wire to terminal 6 of the pump relay. Push an UP arrow, the pump should run. If the pump runs, continue the test. If the pump will not run and the pump LED is off, replace the pump relay. **SEE: MP84.3240**

3. The master and pump relay LEDs are on while pushing an UP arrow. The pump does not run. The lit pump LED indicates the master relay is working. Check for voltage at the pump motor on terminal #9 while any UP arrow is being pushed. Use the ground stud or bolt on the side of the pump for the test equipment ground. If there is at least 9 volts present at terminal #9, the pump motor should run. The pump will sound very sluggish when the voltage is below 10 volts, but it will run. If voltage is present, replace the pump motor. If voltage is not present, continue with the following diagnostic. **SEE: MP84.3240**

Note: Although the pump motor is bad if there is at least 9 volts at the motor and it will not run, there are also other issues with the system such as ground issues, connection issues, wiring issues or battery issues. These things should be checked. If everything is correct, voltage at the pump motor should remain well above 10 1/2 volts with the pump running under load.

Use battery power from terminal 1 of the master relay to check terminal 8 of the pump relay for ground. Fix the ground connection for terminal 8 if necessary. If the pump now runs, continue with testing for PART 7. If the ground for terminal 8 is ok, use terminal 8 of the pump relay to check for +12 volts on terminals 5, 6 and 7 of the pump relay. **SEE: MP84.3240**

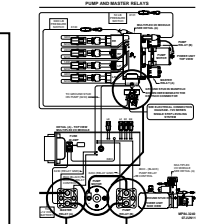
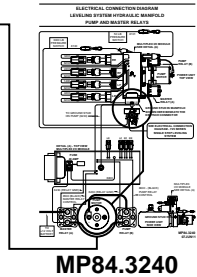
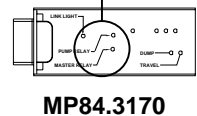
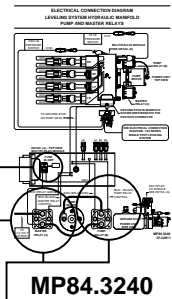
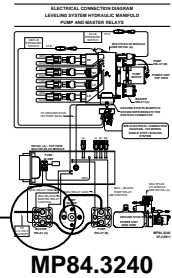

725 TROUBLE SHOOTING STEPS

MANUAL SYSTEM OPERATION

PART 7a. SECTION B.3. CONTINUED

If there is no voltage on terminal 5 of the pump relay, there is a problem with the cable between the master and pump relay or a problem with the cable connections on terminal 4 of the master relay or terminal 5 of the pump relay. Repair as necessary. **SEE: MP84.3240**

If there is voltage on terminal 5 but not terminal 6 of the pump relay, there is a problem with the connection for wire 8600 to terminal 6, a problem with the 8600 wire, or a problem with the I/O module. If there is no voltage on the ring terminal for the 8600 wire, remove a small amount of insulation from the wire close to the I/O module.

If there is no voltage on the 8600 wire at the module, replace the module. If there is voltage, repair the wire if possible. If not possible, the I/O module will have to be replaced. If there is voltage on the ring terminal, clean and repair the connection of the ring terminal to the number 6 terminal of the pump relay. If the pump now runs, continue with PART 7. If the pump still does not run with power on terminal 6, continue to the next paragraph. **SEE: MP84.3240**

If there is voltage on terminal 5 and 6 and ground on terminal 8 of the pump relay, but there is no voltage on terminal 7 of the pump relay, the pump relay needs to be replaced. **SEE: MP84.3240**

C. THE PUMP WILL RUN WHEN PUSHING ONE OR MORE UP ARROW BUTTONS BUT WILL NOT RUN WHEN PUSHING A DIFFERENT UP ARROW BUTTON. The touch panel will have to be replaced.

D. THE PUMP RUNS UNDER NO LOAD WHEN PUSHING ANY UP ARROW BUTTON. No jacks are extending or jacks are extending slowly and will not properly lift the vehicle and there are no visible oil leaks. If the vehicle is equipped with HWH room extension mechanisms, make sure none of the rooms are moving while trying to operate the jacks. If the vehicle is equipped with HWH room extension mechanisms, check to see if the rooms are operating properly.

Make sure there is the proper amount of fluid in the reservoir. If the reservoir is full, the problem will be low pump pressure or a faulty shuttle valve. You will need a 5000 psi pressure gauge to check this. A gauge may be obtained from HWH Corporation. Remove the U shaped tube from the manifold fitting, not the shuttle valve. Attach the pressure gauge to the manifold fitting. With the ignition on, jump +12 volts from terminal 5 of the pump relay to terminal 6 of the pump relay. The pump should start running. Check the pressure. The pump should have 3500 psi. The acceptable range is 3300 psi. to 3600 psi. If the pump is only several hundred psi low, the relief valve on the pump can be adjusted to bring the pressure up to the acceptable range. If the pump pressure is drastically low, check voltage at the pump motor while running under load. If the voltage is below 9 volts, check connections, the pump ground, master and pump relays, cables and the battery supply. Repair problem equipment so there is at least 10.5 volts or more at the pump motor when running under a load. If voltage at the pump motor is ok and pump pressure is low, replace the pump. If pump pressure is acceptable, replace the shuttle valve. **SEE: MP64.3917 and MP84.3240**

E. THE PUMP RUNS UNDER LOAD WHEN PUSHING ANY UP ARROW BUTTON BUT NO JACKS ARE EXTENDING. Check the individual solenoid valve LEDs on the I/O module while pushing an UP arrow button. The appropriate solenoid valve LEDs should come on while pushing an UP arrow button. **SEE: MP84.3170**

1. If the solenoid valve LEDs are coming on while pushing UP arrow buttons, this indicates the solenoid valves should be opening. Manually open a solenoid valve and push an up arrow button.

a. If the jack will not extend with the valve manually open, the problem is most likely the shuttle valve. Refer to Section C. and check the pump pressure. There should be 3500 psi with the pump running under load and nothing moving. If there is 1000 psi or more, a jack should extend with the solenoid valve manually opened. If there is low pump pressure, check voltage at the pump motor while running under load.

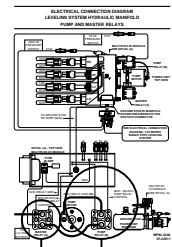

MP84.3240

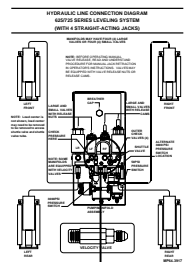

MP64.3917

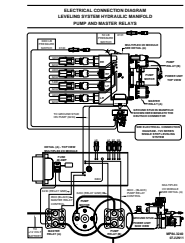

MP84.3240

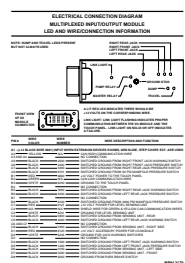

MP84.3170

725 TROUBLE SHOOTING STEPS

MANUAL SYSTEM OPERATION

PART 7a. SECTION E.1.a. CONTINUED

If the voltage is below 9 volts, check electrical connections, the pump ground, master and pump relays, cables and the battery supply. Repair problem equipment so there is at least 10.5 volts or more at the pump motor when running under load. If pump pressure is ok, replace the shuttle valve. **SEE: MP64.3917 and MP84.3240**

b. If the jack extends after manually opening the valve, there is a valve or voltage issue. With the valve plugged in, check voltage between the white and black wire for the solenoid valves while pushing the UP arrow buttons. If there is a minimum of 8.5 volts at the valve, the valve should open. If voltage is low, check the voltage at terminal #3 of the master relay while pushing an up arrow. If voltage is good at the relay and low at the valves, there is a problem with the I/O module or the main ground for the I/O module. If voltage is low at the master relay, check voltage into the relay and replace or repair equipment as needed to fix the voltage problem. If voltage at the solenoid valves is ok, the problem is the solenoid valves. It would be rare to have 4 bad valves so you should contact HWH Corporation to discuss possible issues that could cause all 4 valves to be bad. **SEE: MP84.3240**

If voltage is good at the relay and low at the valves, there is a problem with the I/O module or the main ground for the I/O module. If voltage is low at the master relay, check voltage into the relay and replace or repair equipment as needed to fix the voltage problem. If voltage at the solenoid valves is ok, the problem is the solenoid valves. It would be rare to have 4 bad valves so you should contact HWH Corporation to discuss possible issues that could cause all 4 valves to be bad. **SEE: MP84.3240**

2. If the solenoid valve LEDs are not coming on while pushing UP arrow buttons and the pump is running, there are two possibilities. Either the I/O module is bad or there are 4 bad solenoid valves. Make sure the valves are marked so they can be reconnected easily. Unplug all four valves and make sure the ignition is off. Wait several minutes. Turn the ignition on and check the solenoid valve LEDs while pushing an UP arrow button. If the LEDs do not come on, replace the I/O module. If the LEDs come on, plug the valves back in. Again check the LEDs while pushing an UP arrow button. If the LEDs come on and stay on, the jacks should be extending. If they are not extending, check PART 7 Section E part 1. If the LEDs do not come on or come on briefly and go out, replace the solenoid valves. **SEE: MP84.3240**

F. ONE OR MORE JACKS WILL NOT EXTEND. OTHER JACKS ARE WORKING PROPERLY AND THE PUMP IS RUNNING NORMALLY. Check the appropriate solenoid valve LEDs while pushing the UP arrow button. There should always be two solenoid valve LEDs on while pushing an UP arrow button. **SEE: MP84.3170**

1. The solenoid valve LED is coming on while pushing the UP arrow button but the jack will not extend. Manually open the solenoid valve then push an UP arrow button for that jack. **If the jack now extends,** check voltage between the white and black wire for the solenoid valve while pushing the UP arrow button with the valve plugged in. If voltage is 8.5 volts or better, replace the solenoid valve. If voltage is low, check voltage at other valves that are working. If voltage is marginal for other valves, check system voltage at the master relay. If there is low voltage only at one valve, replace the I/O module. **If the jack still does not extend,** remove that jack hose from the manifold and attach a pressure gauge to the manifold fitting. Check the pressure while pushing the UP arrow button. **If there is good pressure,** reconnect the hose to the manifold and remove the hose at the jack. There should be a good flow of fluid to the jack when pushing the UP arrow. If there is no flow, the hose is the problem. If there is good flow, replace the jack cylinder. **If there is no pressure,** there is a problem with the solenoid valve or the inner check valve for that jack. Contact HWH Corporation for assistance. **SEE: MP64.3917 and MP84.3240**

2. The solenoid valve LED for the jack that will not extend is not coming on while pushing the UP arrow button. Make sure the ignition is off. Unplug the valve for the jack that will not extend. Wait a couple minutes then turn the ignition back on to the "ACC." position and check the solenoid valve LED while pushing the appropriate UP arrow button. If the LED does not come on, replace the I/O module. If the LED is coming on, plug the valve back in and retry. If the LED will not come on or comes on briefly and goes out, replace the solenoid valve. If the LED is staying on but the jack will not extend, check Part 1 of this section. **SEE: MP84.3240**

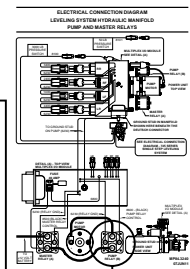

MP84.3240

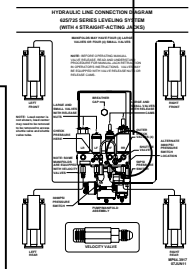

MP64.3917

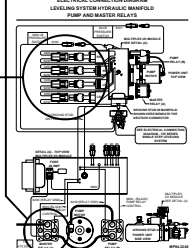

MP84.3240

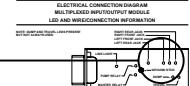

MP84.3170

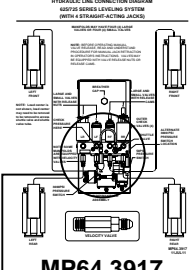

MP64.3917

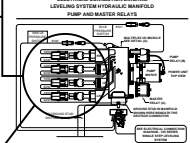

MP84.3240

725 TROUBLE SHOOTING STEPS

MANUAL SYSTEM OPERATION

PART 7a. SECTION K. CONTINUED

G. JACKS EXTEND BUT EXTEND SLOWLY OR WILL NOT LIFT THE VEHICLE.

There is low pump pressure or a shuttle valve problem. Go back to PART 7a. Section D.

H. A JACK EXTENDS WHEN IT SHOULDN'T. When pushing an UP arrow button, the appropriate jacks extend but a third jack is also extending.

1. The jack that should not extend retracts as soon as the UP arrow button is released.

Check the solenoid valve LED for the jack that should not extend. If the LED is staying on, replace the I/O module. If the LED is not on or it is not coming on while pushing an UP arrow button, replace the solenoid valve. (Make sure you are not pushing an UP arrow button that would operate that jack.)

SEE: MP84.3170

2. The jack that should not extend is staying down when the UP arrow button is released.

Check the appropriate solenoid valve LED while pushing the UP arrow button. The LED is most likely coming on. If it is, replace the I/O module. If the LED is not coming on, replace the solenoid valve.

SEE: MP84.3170

I. THE WRONG JACKS EXTEND WHEN AN UP ARROW BUTTON IS PUSHED. If the system has been working properly, this can only happen if wiring or plumbing is changed. Check the appropriate plumbing and wiring diagrams. Change the wiring or plumbing to match the diagrams. If the plumbing is wrong, change the plumbing as necessary. DO NOT just change wiring.

SEE: MP64.3917 and MP84.3240

J. ONE OR MORE JACKS WILL NOT STAY EXTENDED AFTER THE UP ARROW BUTTON IS RELEASED.

There are no visible oil leaks. Make sure all manual release nuts or cam levers are fully closed. Check the solenoid valve LED(s) for the jack(s) that will not stay extended. If the LED(s) are not staying on, replace the solenoid valve(s). If the LED(s) are staying on when the UP arrow button is released, replace the I/O module. **SEE: MP64.3917 and MP84.3170**

Note: If the complaint is that the jacks retract slowly after a period of time, it is important to extend and mark all four jacks to determine which jack or jacks have an issue. Extend all jacks to slightly lift the vehicle. Wait about 20 minutes and then use a felt marking pen or piece of tape to mark on the jack rod 1 inch down from the bottom of the cylinder tube. The vehicle should not be disturbed for the amount of time the operator indicates it takes for the jacks to retract. If the vehicle is in a controlled environment, there should be no movement of the jack rods. If there is a possible change in temperature, getting cooler, the movement of the rod should be no more than 3/8 to 1/2 inch maximum. Only change solenoid valves that allow the jacks to move more than discussed here.

K. A RED JACK DOWN WARNING LIGHT WILL NOT COME ON. THE JACK IS EXTENDED

1/2 INCH OR MORE. The jack warning switch has normally closed contacts. When the jack is retracted, a magnet inside the jack is close to the switch and the switch contacts open. As the jack extends, the magnet is pulled away from the switch and the contacts close. When the contacts close, this completes a ground circuit for the warning light.

With the jack extended, unplug the warning switch. Use a small jumper to short the two pins in the harness Packard connector together. If the warning light now comes on, replace the warning switch. If the warning light does not come on, use the jumper to apply a good ground to the warning switch signal wire. That will be the black wire going to the B pin in the packard connector. If the warning light now comes on, there is a problem with the white ground wire in the harness. If the warning light still does not come on, unplug the 32 pin connector from the I/O module. Check for continuity between pin D2 and the correct pin for the warning switch that is not coming on. **SEE: MP84.3130 and MP84.3170**

Right front switch is pin A5 - wire #2000

Left front switch is pin - wire #1000

Right rear switch is pin - wire #3000

Left rear switch is pin - wire #4000

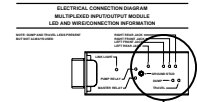

MP84.3170

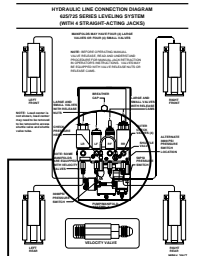

MP64.3917

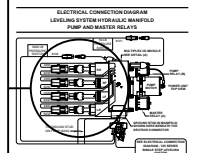

MP84.3240

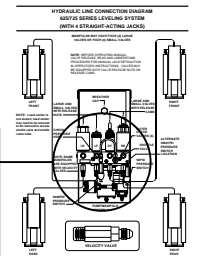

MP64.3917

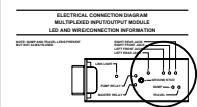

MP84.3170

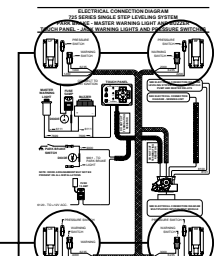

MP84.3130

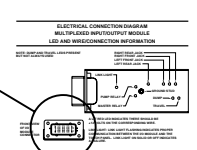

MP84.3170

**MI91.327N
01NOV11**

725 TROUBLE SHOOTING STEPS

MANUAL SYSTEM OPERATION

PART 7a. SECTION K. CONTINUED

Make sure the two pins in the warning switch harness plug are shorted together. If there is no continuity, there is a problem with the warning switch wire or ground wire from the D2 pin. If there is good continuity between the two pins, check and record the voltage between pin D1 of the 32 pin harness connector and the brass ground stud on the top of the I/O module. Plug the 32 pin connector back in. Remove the jumper from the two pins in the warning switch harness connector.

Check the voltage between the black warning switch wire (close to the I/O module) and the brass ground stud on the top of the I/O module. Strip some insulation from the wire close to the connector. Make sure to repair the wire with some type of sealant when the test is finished. The voltage should be within less than 1 volt of the voltage you recorded on pin D1 of the harness connector. If there is a difference in the voltage greater than 1 volt, the I/O module needs to be replaced. If the voltage is good, the problem is the I/O module or touch panel. Replace the touch panel first. If the problem remains, reinstall the original touch panel and replace the I/O module. **SEE: MP84.3170**

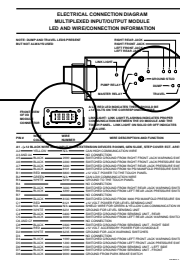

MP84.3170

L. THE MASTER WARNING LIGHT AND/OR BUZZER DO NOT WORK WHEN A JACK IS EXTENDED AND THE TOUCH PANEL HAS AT LEAST ONE RED WARNING LIGHT ON. Normal wiring of the master warning indicators will require the ignition to be in the "ON" position, not the "ACC." position. It is important to check the specific master warning light / buzzer wiring for the system. Although most systems will be wired through the "ON" side of the ignition switch, some may be supplied power from the touch panel. **SEE: MP84.3334 and MP84.9964**

Both warning devices are controlled with one wire (black #7699) from the 6 pin UML connector on the touch panel. This wire is a switched ground if any jack is extended. The ignition must be in the "ON" or "ACC." position to check the #7699 wire. A meter, not a test light, must be used to test this wire. Because the warning light is a LED, both the light and the buzzer have specific + and - polarity.

If one device is working but not the other, the touch panel is ok. If wired as shown, the power supply is also not the problem. (Check exact system wiring) Use a meter to check voltage between the two wires connected to the non-working device, light or buzzer. If voltage is present, the device is bad. If voltage is not present, the problem is in the wiring or connections to the device.

SEE: MP84.9964

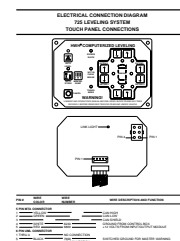

MP84.3334

If neither device is working, use a meter to check between the power wire for the light or buzzer and the 7699 wire. If 12 volts is present, the problem is with the device. If 12 volts is not present, check from a good ground to the power supply wire. **If 12 volts is present**, the problem is the 7699 wire or the touch panel. With the ignition on, use a meter to check between the red 6800 wire in the 5 pin MTA connector on the back of the touch panel and the number 5 pin of the 6 pin UML connector. If there is +12 volts present, the problem is the 7699 wire or its connections at the warning light / buzzer or the 6 pin UML connector. If 12 volts is not present, replace the touch panel. **If 12 volts is not present**, check the inline fuse for the warning light / buzzer supply. If the fuse is good, check for voltage at the fuse. If there is no voltage at the fuse, there is a problem with the power supply. Refer to the vehicle manufacturer for assistance. If there is voltage at the fuse, there is a problem with the wire or its connections. Remember, there is a diode in the power supply wire. If the fuse is bad, there is most likely a short between the fuse and the warning light / buzzer or one of the devices is bad. Disconnect both the light and buzzer. Replace the fuse. With the ignition on and a jack down, connect the light or buzzer. If the fuse blows, the device is bad. Repeat the test with the other device. **SEE: MP84.9964**

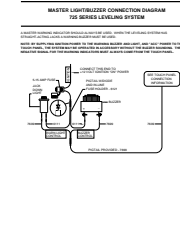

MP84.9964

725 TROUBLE SHOOTING STEPS

MANUAL SYSTEM OPERATION

PART 7b. RETRACTING JACKS WITH DOWN ARROW BUTTONS PUSH AND HOLD THE DOWN ARROW BUTTON. The pump should NOT run. The jacks should retract fully. The red jacks down warning light should go out when its jack is within 1/2 to 1 inch of being fully retracted. If the pump runs when pushing a DOWN ARROW button, replace the touch panel.

A. ONE JACK WILL NOT RETRACT WHEN PUSHING THE DOWN ARROW BUTTON. THE OTHER JACK WILL RETRACT WHEN PUSHING THE DOWN ARROW BUTTON. Check the red LED on the I/O module for the jack that will not retract while pushing the DOWN ARROW button. **SEE: MP84.3170**

1. The red LED is not coming on. Unplug the solenoid valve for the jack that will not retract. Turn the ignition off for a few seconds then back on. Now check the red LED for the jack that will not retract while the DOWN ARROW button is being pushed. If the LED still does not come on, replace the I/O module. If the LED now comes on, plug the solenoid valve back in and retry. If the LED now will not come on, replace the solenoid valve.

Note: If the jack retracts properly after the valve is plugged back in, there may be no problem. If this issue repeats itself at a later time, repeat section A.1. If you get the same results, the solenoid valve is probably boarder line and should be replaced.

2. The red LED is coming on. Use the manual valve release to open the valve. **If the jack will not retract when a solenoid valve is manually opened,** the problem is most likely the jack cylinder but could be a restriction in the hose or an outer check valve problem. If the manifold is equipped with velocity valves, that could also cause a problem. Loosen the hose for the jack at the manifold. If the jack starts to retract, there is most likely a problem with the outer check valve or velocity valve. Contact HWH Technical Service for assistance. If the jack does not retract, reconnect the hose at the manifold and loosen the hose at the jack. If the jack now retracts, there is an issue with the hose. If the jack still does not retract, the jack cylinder should be changed provided the jack return springs are in place and are not stretched out of shape. **SEE: MP64.3917**

WARNING: LOOSENING A HOSE WHEN A JACK IS EXTENDED COULD ALLOW THE VEHICLE TO DROP SUDDENLY CAUSING SEVERE INJURY OR DEATH. DO NOT CRAWL UNDER THE VEHICLE UNLESS THE FRAME OF THE VEHICLE IS PROPERLY SUPPORTED.

If the jack will retract properly with the solenoid valve opened manually, there is a solenoid valve, or voltage problem. Check the voltage between the white and black wire for that valve at the Packard connector while pushing the appropriate DOWN ARROW button. Use small jumper wires between the I/O module plug and the valve plug so the valve is connected while checking voltage. You can check the pin or spring in the middle of the valve while pushing the DOWN ARROW. The pin should move about 0.030 inches when opening. If there is at least 8.5 volts, the valve should open. **If there is adequate voltage** and the valve will not open, replace the valve. If the valve seems to be opening but the jack doesn't retract, the valve is probably the problem. It would be best to contact HWH to discuss the problem. **If there is low voltage to the solenoid valve,** check the voltage to another valve while pushing a DOWN ARROW. If there is adequate voltage to other valves, replace the I/O module. If there is low voltage to other valves, check voltage from the #10 black wire with the 40 amp fuse connected to the switched side of the master relay. If there is good voltage on that wire, replace the I/O module. If there is low voltage on the #10 wire, the problem is the master relay connections, or the battery supply voltage to the master relay. If there is good voltage to the relay, check voltage on terminal 3 of the master relay. If voltage on terminal 3 is good, there is a problem with the connection for the #10 wire or with the 40 AMP fuse holder. If voltage on terminal 3 is low, replace the master relay. If there is low voltage to the master relay, the problem is the battery cable, cable connections at the battery or master relay; or there is battery issues. **Check all connections, including all grounds and the pump mounting for tightness and corrosion.** **SEE: MP64.3917 and MP84.3240**

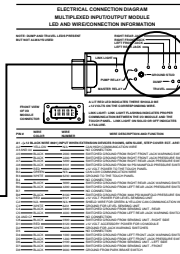

MP84.3170

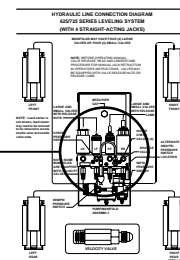

MP64.3917

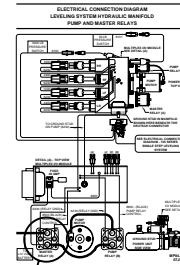

MP84.3240

725 TROUBLE SHOOTING STEPS

MANUAL SYSTEM OPERATION

PART 7b. CONTINUED

D. ONE OR MORE JACKS RETRACT SLOWLY OR NOT COMPLETELY. This will normally be a jack cylinder problem, especially if the jack retracts partially but not completely. Check the jack springs for good tension. Replace any suspected weak springs. If the springs are OK, loosen the hose for the slow jack(s). If the jack now retracts normally, the issue is a solenoid valve or the outer check valve. If the manifold is equipped with velocity valves, a velocity valve could cause a jack to retract slowly. Contact HWH for assistance if a velocity valve problem is suspected. With the solenoid valve closed, remove the outer check valve. If the check valve is free of debris and loose in the check valve cap, replace the solenoid valve. If the check valve appears to have an issue, contact HWH Technical Service for assistance. If the jack still retracts slowly with the hose loosened or removed, reconnect the hose to the manifold and remove the hose at the jack. If the jack retracts normally, the hose is restricted or kinked. If the jack still retracts slowly, or not at all, replace the jack cylinder. **SEE: MP64.3917**

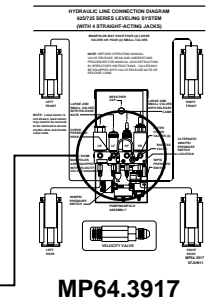

MP64.3917

Note: If all of the jacks are retracting slowly, make sure the pump reservoir breather cap is not plugged or restricted. This is a good thing to check if more than one jack is retracting slowly.

If the jack retracts partially and stops, the problem is most likely the jack cylinder but could be a voltage issue. Usually with a voltage issue, all the jacks will have a retract problem. If the jacks continue to retract with the hoses removed, check system voltage and grounds.

E. ONE OR MORE WARNING LIGHTS WILL NOT GO OUT WITH THE JACKS FULLY RETRACTED. Unplug the jack warning switch at the jack.

1. The warning light goes out with the warning switch unplugged. The problem is the warning switch or the magnet in the jack. Remove the warning switch from the jack. (The jack must be fully retracted) With the warning switch removed, the contacts of the switch should be closed and there should be continuity between the two pins of the warning switch plug. While checking continuity between the two pins, hold a small magnet close to the bottom of the switch. If the contacts of the switch open and continuity is removed between the pins, there is most likely an issue with the magnet. The jack cylinder will have to be replaced. If the contacts remain closed with continuity between the two pins, replace the warning switch. **SEE: MP84.3130**

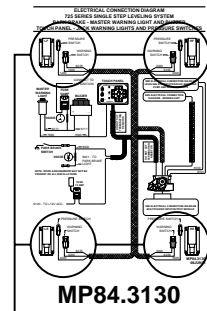

MP84.3130

2. The warning light does NOT go out with the warning switch unplugged. Either the warning switch signal wire is shorted to ground or the I/O module has a problem. Unplug the 32 pin connector at the I/O module. Check for continuity between the signal wire for the warning switch and the ground wire for the warning switches on pin D2. If there is continuity, the wires are shorted and need to be repaired. If there is no continuity between the warning switch signal wire and the ground wire on pin D2, check for continuity between the warning switch signal wire and chassis ground. If there is continuity to ground, the warning switch signal wire is shorted to ground and must be repaired. If there is no continuity to ground, check and record the voltage between pin D1 of the 32 pin harness connector and the brass ground stud on the top of the I/O module. Plug the 32 pin connector back in. Check the voltage between the ground and signal wire in the warning switch plug. The voltage should be within less than 1 volt of the voltage you recorded on pin D1 of the harness connector. If the voltage is good, replace the touch panel. If there is a difference in the voltage greater than 1 volt, the I/O module needs to be replaced. **SEE: MP84.3170**

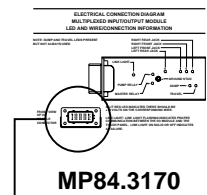

MP84.3170

F. THE MASTER WARNING LIGHT AND BUZZER ARE ON ALONG WITH THE "TRAVEL MODE" LIGHT. Power for the master warning light and buzzer come from the ON side of the ignition switch. The control signal for the master warning light and buzzer is a switched ground on the black wire 7699 that comes from the 6 pin UML connector on the touch panel. **SEE: MP84.3334 SEE: MP84.9964**

Unplug the 6 pin UML connector from the touch panel. If the light and buzzer go out, replace the touch panel. If the light and buzzer remain on, the 7699 wire is shorted to ground and must be fixed.

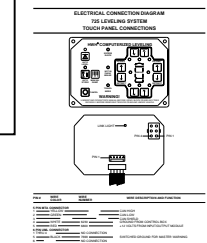

MP84.3334

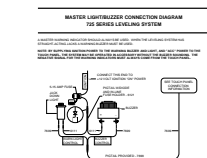

MP84.9964

725 TROUBLE SHOOTING STEPS

MANUAL SYSTEM OPERATION

PART 7b. CONTINUED

G. THE TRAVEL MODE LIGHT WILL NOT COME ON. ALL RED WARNING LIGHTS ARE OUT.

The touch panel is most likely the problem but recheck PART 4. Section B. to confirm this.

PART 8. YELLOW LEVEL INDICATOR LIGHTS AND SENSING UNIT CHECK.

To check the yellow level lights and the level sensing unit adjustments. It is best to start on a level flat surface. Check the adjustment by using the jacks to level the vehicle. A discussion with the vehicle owner is best to determine what "level" is. The ignition must be on with the park brake set to check the level indicator lights. With the vehicle level, no yellow level indicator lights on the touch panel should be lit. If there are level lights on, proceed to Section A. If no level lights are on, use the leveling jacks to make sure 4 yellow level lights work. Use two jacks at a time to raise the vehicle until the appropriate light comes on. Example: Push the front UP ARROW button and lift the front of the vehicle until the rear yellow level light comes on. Use the front DOWN ARROW button to lower the vehicle until the rear yellow level light goes out. Repeat this with the other three sets of UP and DOWN ARROW buttons. If the yellow level lights will not come on or go out, proceed to Section B.

Note: Anytime there seems to be an issue with the yellow level lights, check the mounting of the sensing unit. The sensing unit has an arrow pointing "FRONT" and "THIS SIDE UP" on the top of the sensing unit. Make sure the sensing unit is oriented properly with the right side up. Also the sensing unit needs to be mounted to a solid surface. Type of material for mounting is not important. Make sure the adjustment enhancement cap is in place. SEE MI15.4571

A. LEVEL LIGHTS ARE ON WITH THE VEHICLE LEVEL. Adjust the sensing unit according to MI15.4571. If the sensing unit cannot be adjusted, proceed to Section B.

B. ONE OR MORE YELLOW LEVEL LIGHTS WILL NOT COME ON, NOT GO OUT OR OPPOSING LEVEL LIGHTS ARE LIT. The sensing unit has 4 yellow LED's on the bottom side of the sensing unit. These lights should correspond to the yellow level lights on the touch panel. Push up on the sensing unit to see if the LED's will come on or go out and correspond to the touch panel level lights.

Note: Refer to MP84.3430 for sensing unit wiring information.

- PIN 1 - BLACK - 0400 - GROUND WHEN REAR OF VEHICLE IS LOW**
- PIN 2 - WHITE - 6231 - GROUND FOR THE SENSING UNIT**
- PIN 3 - RED - 6121 - +12 VOLTS FOR THE SENSING UNIT**
- PIN 4 - BLACK - 0100 - GROUND WHEN LEFT SIDE OF VEHICLE IS LOW**
- PIN 5 - BLACK - 0200 - GROUND WHEN FRONT OF VEHICLE IS LOW**
- PIN 6 - BLACK - 0300 - GROUND WHEN RIGHT SIDE OF VEHICLE IS LOW**

1. The yellow LED's on the sensing unit are working but do not correspond to the touch panel level lights. Unplug the sensing unit from the harness. Use a test light to check the harness wires. There is ground and power to the sensing unit or the sensing unit LED's would not function. Use the test light to ground pins 1, 4, 5 and 6 of the harness plug. When ground is applied to the pin, the appropriate touch panel level light should come on and only that one light. If the light does not come on, two lights come on, or a level light will not go out, there is an issue with the harness or the I/O module. Turn the ignition off and unplug the 32 pin connector from the I/O module. With both ends unplugged, the wires for pins 1, 4, 5 and 6 of the sensing unit plug should have continuity from end to end and should not be shorted to any other wire in the harness or to a frame ground. Fix the harness as necessary. If the harness is good, replace the I/O module.

SEE MP84.3170 for sensing unit wire pin out information at the 32 pin harness plug.

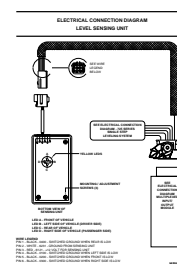

MP84.3430

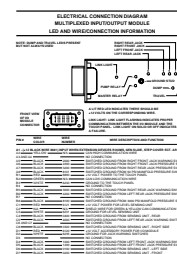

MP84.3170

725 TROUBLE SHOOTING STEPS

MANUAL SYSTEM OPERATION

PART 8. SECTION B CONTINUED

2. The yellow LED's of the sensing unit correspond correctly to the yellow level lights on the touch panel but one or more sensing unit level lights will not come on or go out. The sensing unit will have to be replaced.

SEE MP84.3170 for sensing unit wire pin out information at the 32 pin harness plug.

3. No yellow LED's on the sensing unit come on. Touch panel level lights are not coming on. Unplug the sensing unit from the harness and check for +12 volts between pins 2 and 3 of the harness plug. If voltage is present, replace the sensing unit. If voltage is not present, there is a harness / connection issue or an I/O module problem. Unplug the 32 pin connector from the I/O module. Check for continuity between the pins at both ends of the harness for wires 6121 (+12) and 6231 (ground). Fix the harness as necessary. If the harness is OK, replace the I/O module. SEE MP84.3170 and MP84.3430

AUTOMATIC LEVELING

IMPORTANT: At this time, it is assumed that the leveling system is functioning correctly with manual operation. This includes all touch panel lights and master warning indicators. It is also assumed that the sensing unit has been checked for proper operation and adjustment. If manual operation has not been checked, review the first part of this repair manual. If the system does not function properly with manual operation, automatic operation will most likely not function properly.

AUTOMATIC LEVELING SEQUENCE

It is important to understand the difference between the LEVELING MODE and the STABILIZING MODE. Symptoms that may be similar during the LEVELING and STABILIZING modes may be different problems and require different diagnostics. EXAMPLE: During the LEVELING MODE, a jack will not extend to turn a yellow level light off. This is most likely a solenoid valve issue. During the STABILIZE MODE, the same jack will not extend. This could be a solenoid valve or a jack pressure switch. A jack pressure switch will NEVER interfere with the LEVELING MODE. The only time the system recognizes a jack pressure switch is during the STABILIZE MODE.

LEVELING MODE:

1. With the ignition on (or in ACC.) push the "AUTO LEVEL" button. The AUTO LEVEL light will flash.
2. If the vehicle is equipped with an air suspension, the air will start to dump at this time. The air will dump for approximately 20 - 25 seconds before the leveling sequence starts.
3. the pump will come on and the system will start to extend jacks to level the vehicle. The system will start by extending jacks to turn a lit side yellow level indicator off first. If no yellow level lights are on, the system will go directly to the stabilize mode.
4. The appropriate red jack down warning light on the touch panel will come on as the jacks extend 1/4 to 1/2 inch. If the ignition is in the ON position, the master warning light and buzzer will come on.
5. The system will extend jacks as necessary until the yellow level lights are all off. When all of the level lights are off, there will be a short pause before the system goes into the stabilize mode. While in the stabilization mode, yellow level lights may come back on.

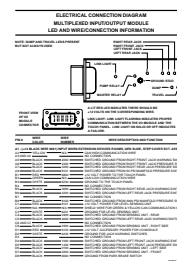

MP84.3170

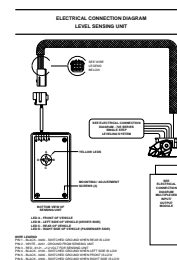

MP84.3430

725 TROUBLE SHOOTING STEPS

AUTOMATIC LEVELING SEQUENCE

AUTOMATIC LEVELING SEQUENCE CONTINUED

STABILIZE MODE:

6. Stabilize mode is when any jack not used to level the vehicle is extended to the ground. Jacks that are used to stabilize the vehicle should lift the vehicle between 1/4 and 3/4 inch after the jack touches the ground. Each jack has a pressure switch mounted on it. The pressure switch is a normally open, one wire switch. The switch closes when the jack touches the ground and lifts the vehicle 1/4 to 3/4 inch. The closed switch sends a ground signal to the I/O module.

7. In the stabilize mode, the system follows a set procedure for checking the jack pressure switches and extending jacks as needed to stabilize the vehicle. The procedure is as follows:

1. Check the right rear jack pressure switch. Extend the jack if necessary until the jack pressure switch comes on.
2. Check the left rear jack pressure switch. Extend the jack if necessary until the jack pressure switch comes on.
3. Recheck the right rear jack pressure switch and extend the jack if necessary.
4. Recheck the left rear jack pressure switch and extend the jack if necessary.
5. Check both front jack pressure switches. If either jack pressure switch is not on, extend both front jacks at the same time until both front jack pressure switches are on.

Note: If one of the front jacks is already on the ground, because of the check valve arrangement in the manifold and fluid flowing to the path of least resistance, the jack on the ground should extend very little if any.

6. When both front jack pressure switches are on, the system will check the yellow level lights. If any light is on, the system will extend jacks as necessary, starting with a lit side level light, to turn all yellow level lights off.
7. When all yellow level lights are off, the system will then shut off, no matter what condition the jack pressure switches are in.

Note: During the stabilize mode, the pump only runs if a jack needs to be extended. The pump will most likely turn on and off several times while checking the jack pressure switches and yellow level lights during the STABILIZE MODE.

8. When the system has completed the stabilize mode, the system will shut off. The red warning lights will remain on until the ignition is turned off. If the ignition is in the ON position, not ACC position, the master warning light and buzzer will be on until the ignition is turned off.

AUTOMATIC LEVELING DIAGNOSTICS

PART 9. AUTOMATIC LEVELING MODE. The ignition is in the "ON" or "ACC" position and the park brake is set.

Note: If there are no yellow level lights lit on the touch panel, the system will go directly to the stabilize mode of the automatic leveling sequence. If the vehicle has an air suspension with a HWH controlled air dump, the system will dump air for approximately 25 seconds and then proceed to the stabilize mode. It is best to have the vehicle in a non-level position so yellow level lights are on to test automatic leveling.

A. THE AUTO LEVEL LIGHT WILL NOT FLASH WHEN THE AUTO LEVEL BUTTON IS PUSHED. THE "NOT IN PARK / BRAKE" LIGHT ON THE TOUCH PANEL IS NOT COMING ON. Push any manual UP ARROW button. If the system functions, replace the touch panel. If the system does not function, review PART 7a. SECTION B.

B. THE AUTO LEVEL LIGHT WILL NOT FLASH WHEN THE AUTO LEVEL BUTTON IS PUSHED. THE "NOT IN PARK BRAKE" LIGHT ON THE TOUCH PANEL IS COMING ON WHILE THE AUTO LEVEL BUTTON IS PUSHED. Review PART 5 for park brake issues.

C. THE AUTO LEVEL LIGHT FLASHES BUT THE SYSTEM IS NOT FUNCTIONING PROPERLY. If the system has functioned properly when being operated manually, the system should perform properly in the auto leveling mode if the auto level light is flashing. During steps 2 thru 5 of the leveling mode, if there is a malfunction, review PART 6 for air dump problems and 7a. for leveling problems.

725 TROUBLE SHOOTING STEPS

AUTOMATIC LEVELING SEQUENCE

PART 10. STABILIZE MODE.

The stabilize mode starts automatically after all of the yellow level lights have gone out.

Note: Unplug the level sensing unit when checking stabilize mode issues. With the sensing unit unplugged, the system will think the vehicle is level and always go immediately into the stabilize mode. Always start with the jacks retracted to make the following tests.

A. A JACK THAT IS BEING EXTENDED DURING THE STABILIZE MODE DOES NOT QUITE REACH THE GROUND OR DOES NOT LIFT THE VEHICLE ENOUGH (1/4 TO 3/4 INCH) TO STABILIZE PROPERLY

Adjusting the jack pressure switch should take care of this. Unplug the jack pressure switch and loosen the jam nut at the top of the switch. Turn the threaded body of the switch clockwise 1/4 turn and retry. Remember to plug the switch back in. Repeat as necessary until the jack extends enough to stabilize the vehicle properly. If the threaded body is turned several full turns with no results, replace the jack pressure switch. **SEE MP84.9690**

B. A JACK WILL NOT EXTEND AT ALL DURING THE STABILIZE MODE. Try to extend the jack using the appropriate manual UP ARROW button. If the jack does not extend, review PART 7a. If the jack extends manually, the problem is the jack pressure switch, a shorted wire to ground or a problem with the I/O module. Unplug the jack pressure switch and retry. **If the jack now extends**, the jack pressure switch should be replaced. **If the jack still does not extend**, unplug the switch and use a volt meter to check the harness wire. If there is voltage on the wire, replace the I/O module. If there is no voltage on the wire, unplug the 32 pin connector from the I/O module. Check the pressure switch wire in the harness for a short to ground. With both ends of the wire unplugged, the wire should show an open circuit. If necessary, repair the wire. If the wire is OK, replace the I/O module. **SEE MP84.3170**

C. A JACK EXTENDS AND LIFTS THE VEHICLE MORE THAN 3/4 INCH BUT DOES NOT FULLY EXTEND.

Try to adjust the jack pressure switch. Unplug the switch and loosen the pressure switch jam nut at the top of the switch. Turn the threaded body of the jack pressure switch counter-clockwise 1/4 turn and retry. Remember to plug the pressure switch back in. Repeat the adjustment as needed. If the threaded body is turned several complete turns with no results, replace the jack pressure switch. **SEE MP84.9690**

D. A REAR JACK CONTINUES TO EXTEND COMPLETELY AFTER REACHING THE GROUND AND THE PUMP WILL NOT SHUT OFF.

The jack pressure switch will not come on, there is a break in the harness wire for the switch or the I/O module is the problem. Unplug the jack pressure switch. Use a small jumper wire to ground the pin in the harness plug and retry. If the jack will now not extend, the jack pressure switch should be replaced. If the jack still extends, unplug the 32 pin connector at the I/O module and check the appropriate wire for continuity from end to end. Fix the wire as necessary. If the wire is OK, replace the I/O module. **SEE MP84.3130**

E. BOTH FRONT JACKS CONTINUE TO EXTEND COMPLETELY AFTER REACHING THE GROUND AND THE PUMP WILL NOT SHUT OFF.

One or both jack pressure switches will not come on, there is a break in the harness wire for one or both switches; or the I/O module is the problem. Unplug both front jack pressure switches and use small jumper wires to ground the pins in the harness plugs for both switches and retry. Neither jack should extend. **SEE MP84.9690**

1. Both jacks still extend. The problem is in the harness or the I/O module. Unplug the 32 pin connector at the I/O module. Check both front pressure switch wires in the harness for continuity from end to end of the wire. Fix the wire(s) as necessary. If the wires are OK, replace the I/O module. **SEE MP84.3170**

2. Neither jack will extend. One or both of the jack pressure switches are not working properly. Remove one jumper wire, plug that jack pressure switch back in and retry. When the jack with the plugged in pressure switch reaches the ground and lifts slightly, both jacks should stop extending. If the jacks continue to extend, the jack pressure switch that is plugged in needs to be replaced. Repeat this test, reversing the position of the jumper wire to check the other front jack pressure switch. **SEE MP84.3130**

Note: In the stabilize mode, if a pressure switch is not coming on, the pump will continue to run after the jack reaches full extension. This will cause the 3000 psi manifold pressure switch to come on. If the pump runs for 20 seconds after the manifold pressure switch comes on, the "EXCESS SLOPE" light on the touch panel will come on.

ADJUSTMENT FOR JACK PRESSURE SWITCHES

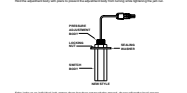

MP84.9690

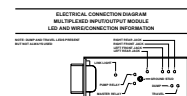

MP84.3170

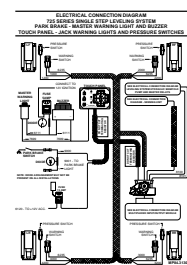

MP84.3130

725 TROUBLE SHOOTING STEPS

AUTOMATIC LEVELING SEQUENCE

PART 11. EXCESS SLOPE

EXCESS SLOPE HAPPENS DURING THE AUTOMATIC LEVELING MODE WHEN TWO JACKS REACH FULL EXTENSION AND ONE OR MORE YELLOW LEVEL LIGHTS REMAIN ON. WHEN THIS HAPPENS, THE 3000# PRESSURE SWITCH ON THE MANIFOLD CLOSSES SENDING A GROUND SIGNAL TO THE I/O MODULE. THE PUMP WILL SHUT OFF, THE SYSTEM WILL NOT STABILIZE AND THE TOUCH PANEL WILL TURN OFF WITH THE "EXCESS SLOPE" LIGHT REMAINING ON UNTIL THE JACKS ARE COMPLETELY RETRACTED WITH THE "STORE" BUTTON OR THE PARK BRAKE IS RELEASED.

Note: The leveling system manifold has a 50 psi pressure switch and a 3000 psi pressure switch. Be careful to not interchange the 3000 psi switch with the 50 psi switch.

IMPORTANT: DO NOT LET THE PUMP RUN FOR MORE THAN SEVERAL MINUTES AT A TIME WHEN PERFORMING EXCESS SLOPE TESTS. ALLOW THE PUMP MOTOR TO COOL IF THE MOTOR STARTS TO BECOME HOT.

A. TWO JACKS ARE FULLY EXTENDED WITH A YELLOW LEVEL LIGHT STILL ON. THE PUMP CONTINUES TO RUN AND THE SYSTEM WILL NOT SHOW "EXCESS SLOPE". The 3000 psi manifold pressure switch is bad, the 8100 pressure switch wire is bad, the pump is not developing enough pressure or the I/O module is the problem. In some cases, the shuttle valve may be the problem. Unplug the 3000 psi manifold pressure switch. Use a small jumper wire to ground the pin for the 8100 wire in the harness plug. Retry automatic leveling. The "EXCESS SLOPE" light should come on about 2 seconds after the pump starts to run and the pump should shut off. If the "EXCESS SLOPE" light comes on, the pressure switch is bad or the pump pressure is low. If the "EXCESS SLOPE" light does not come on, the 8100 wire or the I/O module is bad. **SEE MP84.3240**

1. The "EXCESS SLOPE" light comes on and the pump shuts off. Check the pump pressure. There is a U shaped tube connecting a manifold fitting to the shuttle valve fitting. Remove the U shaped tube from the manifold fitting. Attach a 5000 psi pressure gauge to the manifold fitting. Use a small jumper wire to apply +12 volts to terminal 6 of the pump relay. This will run the pump. (The ignition must be on.) Pump pressure should be between 3300 psi and 3600 psi. 3500 psi is the correct pump pressure. **If the pump pressure is below 3100 psi**, the 3000 psi manifold pressure switch may not function. Check the voltage at terminal 9 on the pump while the pump is running. If the voltage at the pump when it is running under load is less than 9 volts, the pump pressure may be affected. The pump has an adjustable relief valve. If the pump pressure is no lower than 2900 psi, it may be possible to turn the pressure up enough that the system will function properly. Refer to **MP64.9960** for relief valve adjustment. If the pressure cannot be adjusted to the required level, replace the pump. **If the pump pressure is OK, replace the 3000 psi manifold pressure switch. SEE MP64.3917, MP64.9980 & MP84.3240**

Note: If replacing the 3000 psi pressure switch does not fix the problem, the shuttle valve may be the issue. Recheck and record the pump pressure as explained above in Section A. Part 1. If pump pressure is still adequate, reconnect the U shaped tube. Retract all of the jacks. At the manifold, disconnect one of the jack hoses for a jack that was extending completely. Connect the pressure gauge to the manifold fitting. Use the valve release nut or valve release cam to manually open the valve. Use a jumper wire to run the pump as explained above in Section A. Part 1. If the pressure reading is now lower than the recorded pressure, replace the shuttle valve. If the pressure is still above 3300 psi, recheck PART 11 section A.1. or contact HWH Technical Service.

2. The "EXCESS SLOPE" light does not come on and the pump continues to run. Unplug the 3000 psi pressure switch and unplug the 32 pin connector at the I/O module. Check for continuity between the pins for the 8100 pressure switch wire. Repair the wire if necessary. If the 8100 wire is OK, replace the I/O module. **SEE MP84.3170**

B. TWO JACKS ARE NOT FULLY EXTENDED BUT THE "EXCESS SLOPE" LIGHT IS COMING ON AND THE PUMP IS SHUTTING OFF. There are two possibilities. The 3000 psi manifold pressure switch is coming on too soon or the vehicle weight may be greater than the capacity of the jacks. First, it is important to measure how far the jacks are extending to make sure they are fully extended. To test the pressure switch, retract the jacks with the "STORE" button. Install a 5000 psi pressure gauge inline with the shuttle valve. Put the system in the automatic level mode and monitor the pressure gauge to see when the "EXCESS SLOPE" light comes on. If the pressure switch is coming on too low, replace the pressure switch. If the pressure switch is coming on at 3000 psi or more, the capacity of the jacks may be the issue. Contact HWH Technical Service for assistance. **SEE MP64.3917**

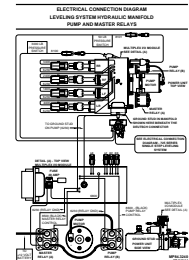

MP84.3240

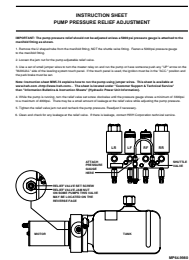

MP64.9980

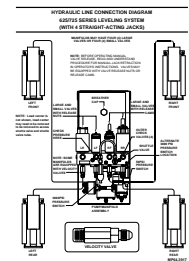

MP64.3917

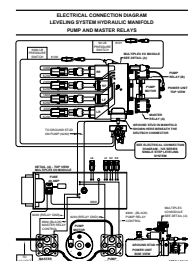

MP84.3240

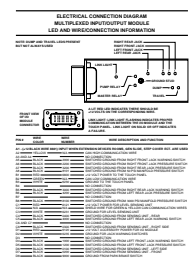

MP84.3170

725 TROUBLE SHOOTING STEPS

AUTOMATIC STORE (RETRACT) SEQUENCE

1. The ignition must be in the ON or ACC. position. If the ignition is in the ON position, the master warning light and buzzer will be on while the jacks are retracting. The "STORE" button will function with the park brake released.
2. Push the "STORE" button. The store indicator light should start flashing.
3. If the vehicle is equipped with an air suspension, the suspension should start to return to ride height at this time. Movement of the suspension will depend upon the amount of air supply in the suspension air tanks. If the engine is not running, the suspension may not completely return to the proper ride height.
4. The two front jacks should start to retract as soon as the "STORE" button is pushed.
5. Five seconds after the front jacks start to retract, the rear jacks will start to retract.
6. Each individual jack warning light will go out as the jack retracts to within approximately 1/2 inch of being fully retracted.
7. One (1) minute after the last red jack warning light goes out, the store indicator light will go out. The "TRAVEL MODE" light will be on and if the park brake is set (with the ignition in ON or ACC.) one or two yellow level indicator lights may be on. If the ignition is in the ON position, the master warning light and buzzer will turn off at this time.

Note: If one or more jacks will not retract and / or red jack down warning lights remain on, the system will stay in the STORE mode for fifty (50) minutes from the time the "STORE" button was pushed. The "TRAVEL MODE" light will not be on. Any lit red warning lights will remain on. After fifty (50) minutes, the store indicator light will go out. The "TRAVEL MODE" light will remain off. Any red warning lights that were on will stay on.

AUTOMATIC STORE DIAGNOSTICS

PART 12. DIAGNOSTICS FOR THE AUTOMATIC STORE SEQUENCE.

Almost all diagnostics for problems encountered during the auto store sequence will be diagnosed using the manual retract diagnostic section.

A. THE STORE INDICATOR LIGHT WILL NOT COME ON AND FLASH WHEN THE "STORE" BUTTON IS PUSHED.

Push any UP or DOWN ARROW button. If any manual buttons function, replace the touch panel. If no buttons on the touch panel function, restart diagnostics with PART 4. of this manual.

B. ONE OR MORE JACKS WILL NOT RETRACT. Review PART 7b. Section A and B.

C. NO JACKS WILL RETRACT. Review PART 7b. Section C.

D. ONE OR MORE JACKS RETRACT SLOWLY OR NOT COMPLETELY. Review PART 7b. Section D. Always make sure the pump reservoir breather cap is not restricted or plugged.

E. ONE OR MORE RED WARNING LIGHTS ON THE TOUCH PANEL WILL NOT GO OUT. THE JACKS ARE COMPLETELY RETRACTED. Review PART 7b. Section E.

F. THE MASTER WARNING LIGHT AND BUZZER ARE ON ALONG WITH THE "TRAVEL MODE" LIGHT.

Review PART 7b. Section F.

G. THE TRAVEL MODE LIGHT WILL NOT COME ON. ALL RED WARNING LIGHTS ARE OUT. The touch panel is most likely the problem but recheck PART 4. Section B. to confirm this.

H. FOR VEHICLES WITH AIR SUSPENSIONS AND HWH CONTROLLED AIR DUMP. THE VEHICLE WILL NOT RETURN TO RIDE HEIGHT. Review PART 6.

INSTRUCTION SHEET

SENSING UNIT MAINTENANCE/SERVICE

REMOTE MOUNTED "POTTED" ELECTRONIC SENSING UNIT

SENSING UNIT ACCURACY TOLERANCE

The sensing unit has an accuracy tolerance of ± 5.4 inches front to rear and ± 1 inch side to side on a 36 foot vehicle. Typical leveling results will be better.

SENSING UNIT ADJUSTMENT / WITH ADJUSTING ENHANCEMENT

Level the vehicle by placing a bubble level in the center of the freezer floor or upon whichever surface within the vehicle that is to be level. It is best if the level is placed close to the mounting area of the sensing unit. Using the Leveling System and the bubble level, ignoring the yellow LEVEL lights on the Touch Panel, level the vehicle until the bubble is centered.

With the vehicle level according to the bubble level, if there are no yellow lights lit on the Touch Panel, the sensing unit is properly adjusted. If there are yellow LEVEL lights lit on the Touch Panel, manual adjustments to the Sensing Unit are needed.

The ignition (motorized units) or master power switch (towable units) must be on. Remove the "Adjusting Enhancement Cap". **DO NOT LOSE THIS CAP.** There is a small pin beneath the cap. Use a jumper wire with an alligator clip to apply a ground to the pin. This will make the sensing unit very sensitive. The yellow lights may "jump" around while adjusting the sensing unit. Let the lights settle down after each adjustment. Small, gentle turns will work best. Turn mounting screws 1 and 3 to adjust the sensing unit. Turn screws as instructed to turn out all the yellow LEDs. When all the LEDs are out, remove the jumper wire and replace the adjusting enhancement cap. **DO NOT** over tighten.

Move the vehicle to an unlevel position and level the vehicle according to the yellow level sensing lights on the touch panel. Readjust if necessary.

IMPORTANT: THE SENSING UNIT MOUNTING SPRINGS SHOULD BE COMPRESSED ABOUT 1/2 THEIR FREE LENGTH. SCREW NUMBER 2 SHOULD NOT BE TURNED WHILE ADJUSTING THE SENSING UNIT. AFTER ADJUSTING THE SENSING UNIT, BUMP THE SENSING UNIT TO SEE THAT IT IS SETTLED TIGHT AGAINST ALL THREE SCREW HEADS AND STILL INDICATES THAT THE UNIT IS LEVEL.

NOTE: If opposing LED's are lit, there is a problem with the Sensing Unit.

If LED (A) is lit: Tighten adjustment screw number 1 until the LED is off.

If LED (C) is lit: Loosen adjustment screw number 1 until the LED is off.

If LED (B) is lit: Loosen adjustment screw number 3 until the LED is off.

If LED (D) is lit: Tighten adjustment screw number 3 until the LED is off.

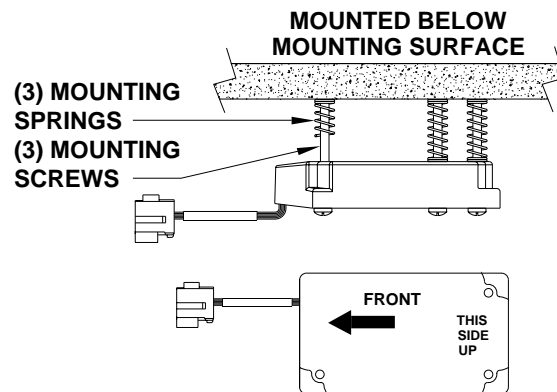
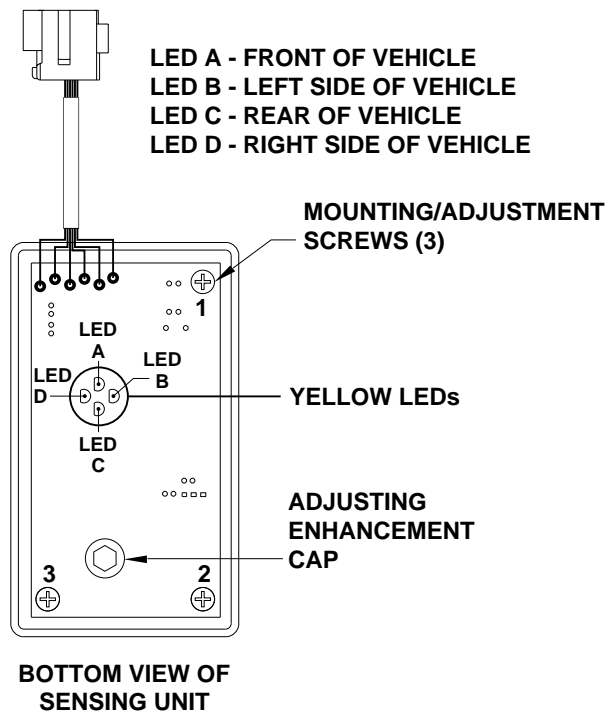

HYDRAULIC LINE CONNECTION DIAGRAM

625/725 SERIES LEVELING SYSTEM

(WITH 4 STRAIGHT-ACTING JACKS)

MANIFOLDS MAY HAVE FOUR (4) LARGE VALVES OR FOUR (4) SMALL VALVES

NOTE: BEFORE OPERATING MANUAL VALVE RELEASE, READ AND UNDERSTAND PROCEDURE FOR MANUAL JACK RETRACTION IN OPERATOR'S INSTRUCTIONS. VALVES MAY BE EQUIPPED WITH VALVE RELEASE NUTS OR RELEASE CAMS.

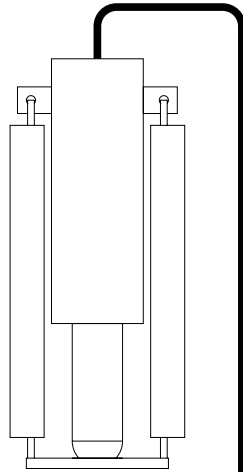

LEFT FRONT

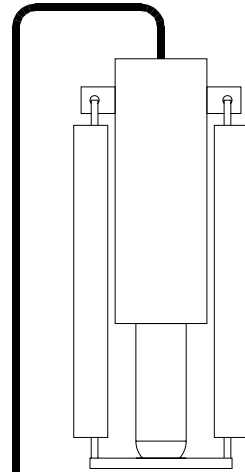

RIGHT FRONT

NOTE: Load center is not shown, load center may need to be removed to access shuttle valve and shuttle valve tube.

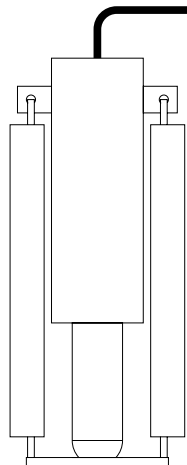
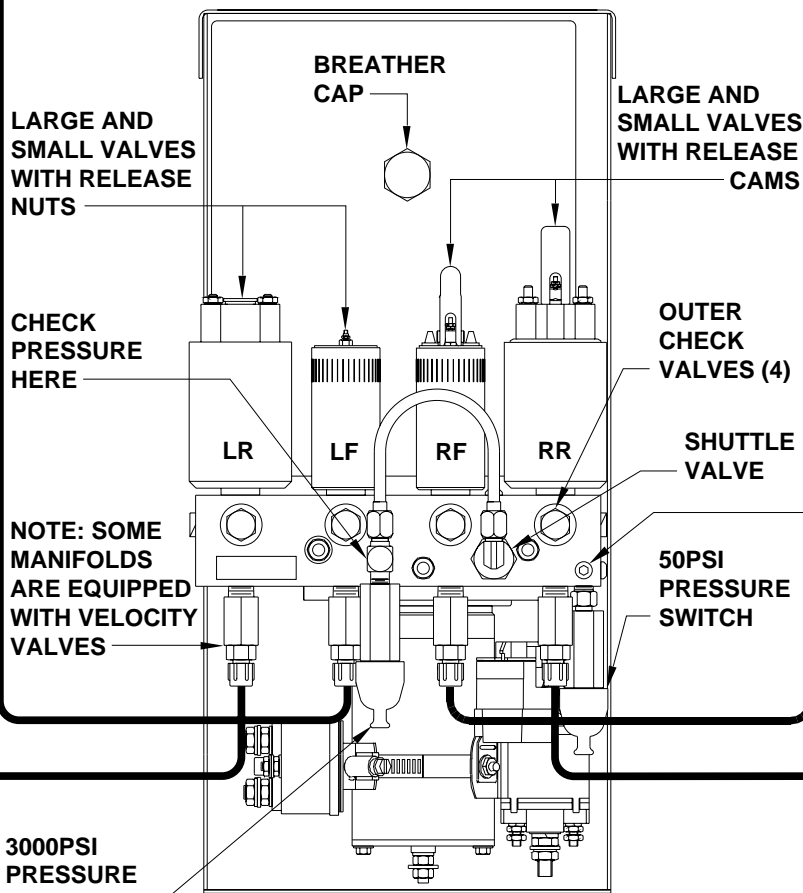

LEFT REAR

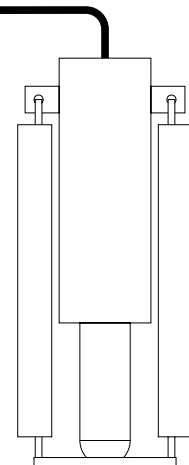

RIGHT REAR

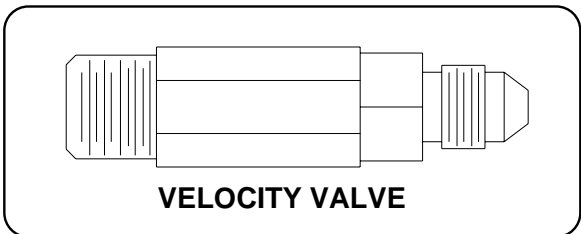

HYDRAULIC SCHEMATIC DIAGRAM

BI-AXIS LEVELING WITH STRAIGHT-ACTING JACKS

625, 625S OR 725 SERIES

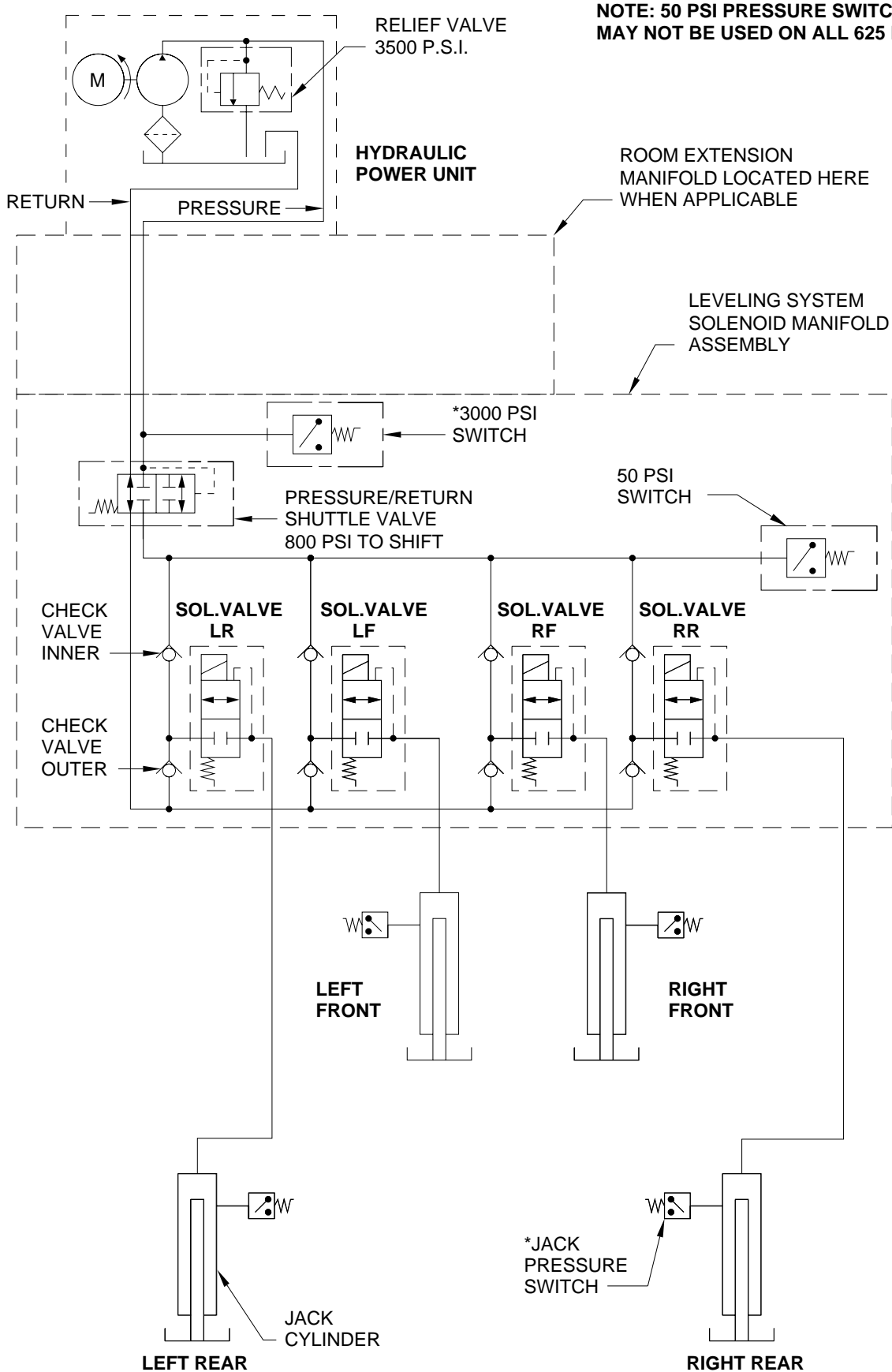

* USED ON AUTOMATIC SYSTEMS ONLY

MP64.4530
29MAR10

INSTRUCTION SHEET

PUMP PRESSURE RELIEF ADJUSTMENT

IMPORTANT: The pump pressure relief should not be adjusted unless a 5000 psi pressure gauge is attached to the manifold fitting as shown.

1. Remove the U shaped tube from the manifold fitting, NOT the shuttle valve fitting. Fasten a 5000psi pressure gauge to the manifold fitting.
2. Loosen the jam nut for the pump adjustable relief valve.
3. Use a set of small jumper wires to turn the master relay on and run the pump or have someone push any "UP" arrow on the "MANUAL" side of the leveling system touch panel. If the touch panel is used, the ignition must be in the "ACC." position and the park brake must be set.

Note: Instruction sheet MI95.74 explains how to run the pump using jumper wires. This sheet is available at www.hwh.com <<http://www.hwh.com>> . The sheet is located under "Customer Support & Technical Service" then "Information Bulletins & Instruction Sheets" (Hydraulic Power Unit Information).

4. While the pump is running, turn the relief valve set screw clockwise until the pressure gauge shows a minimum of 3300psi to a maximum of 3600psi. There may be a small amount of leakage at the relief valve while adjusting the pump pressure.
5. Tighten the relief valve jam nut and recheck the pump pressure. Readjust if necessary.
6. Clean and check for any leakage at the relief valve. If there is leakage, contact HWH Corporation technical service.

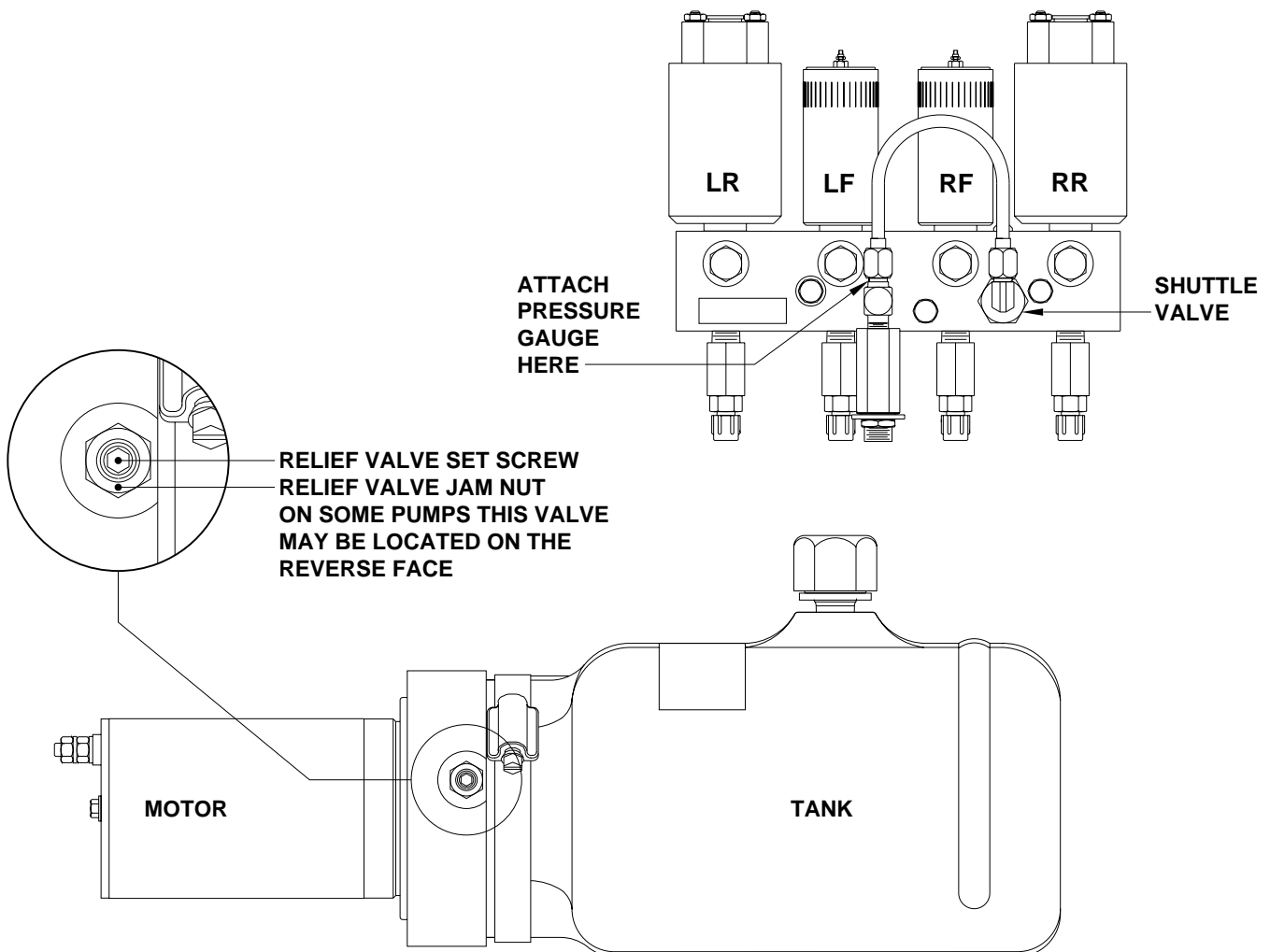

ELECTRICAL CONNECTION DIAGRAM

725 SERIES SINGLE STEP LEVELING SYSTEM

PARK BRAKE - MASTER WARNING LIGHT AND BUZZER

TOUCH PANEL - JACK WARNING LIGHTS AND PRESSURE SWITCHES

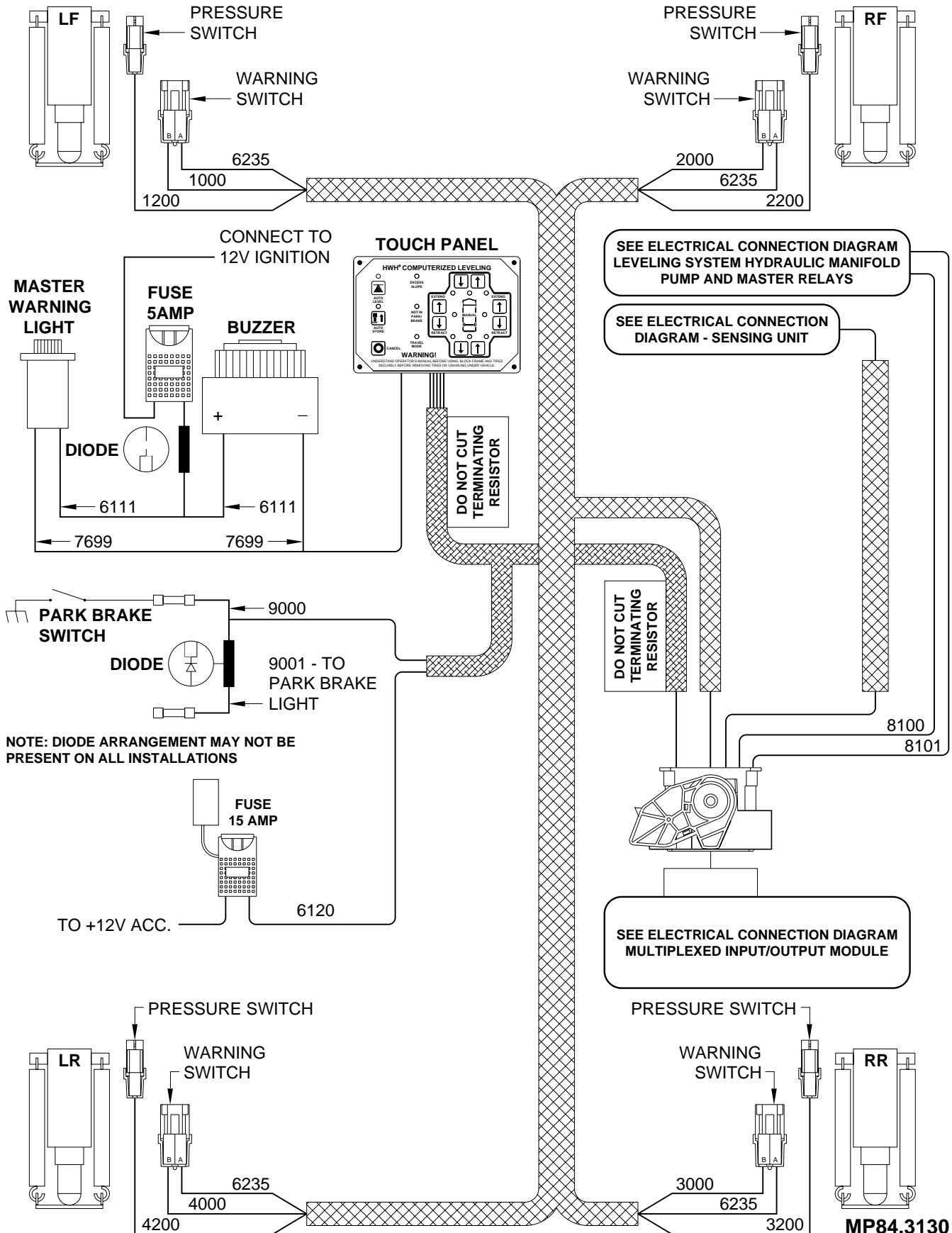

ELECTRICAL CONNECTION DIAGRAM

725 SERIES SINGLE STEP LEVELING SYSTEM

PARK BRAKE - MASTER WARNING LIGHT AND BUZZER

TOUCH PANEL - JACK WARNING LIGHTS AND PRESSURE SWITCHES

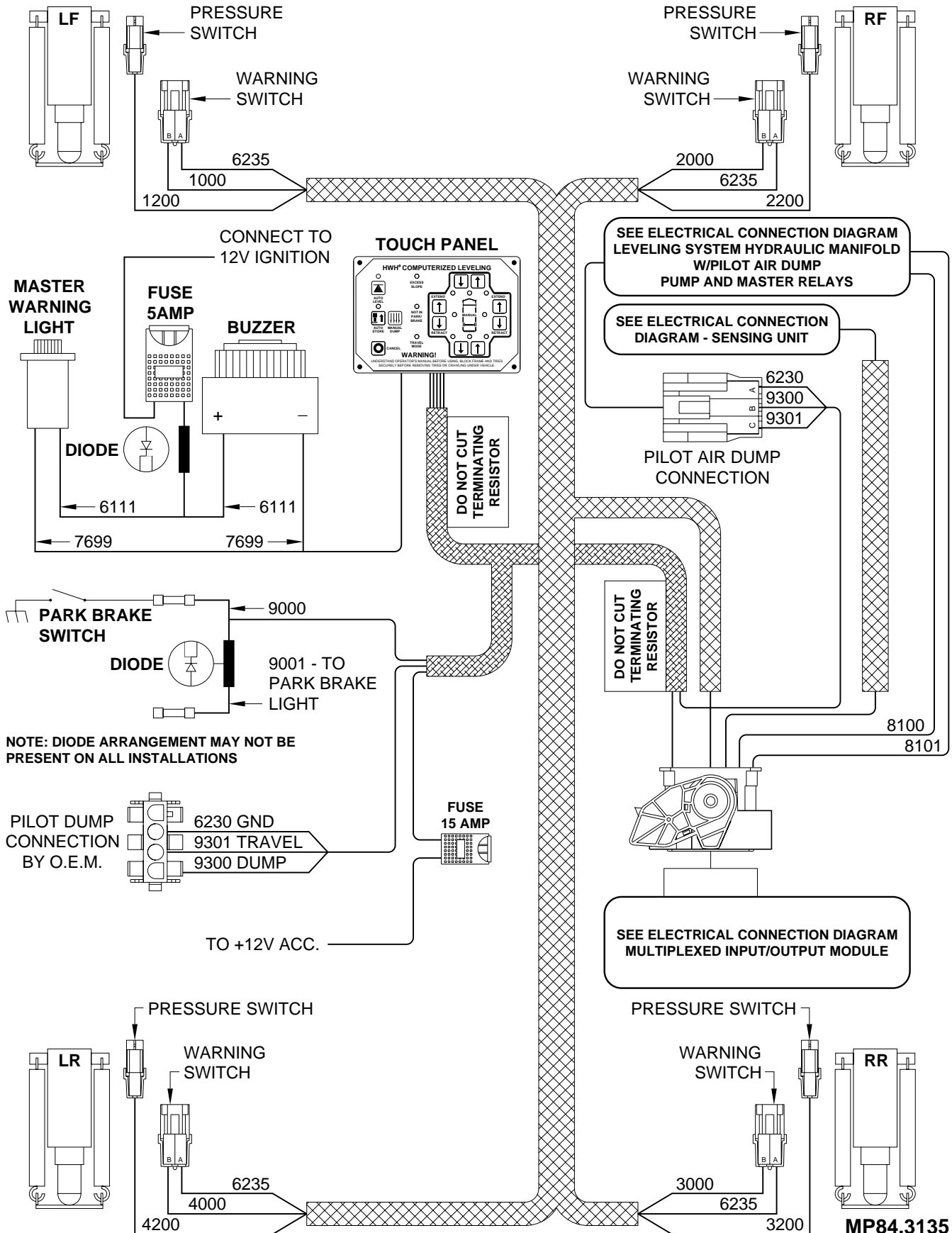

ELECTRICAL CONNECTION DIAGRAM

MULTIPLEXED INPUT/OUTPUT MODULE

LED AND WIRE/CONNECTION INFORMATION

NOTE: DUMP AND TRAVEL LEDS PRESENT BUT NOT ALWAYS USED

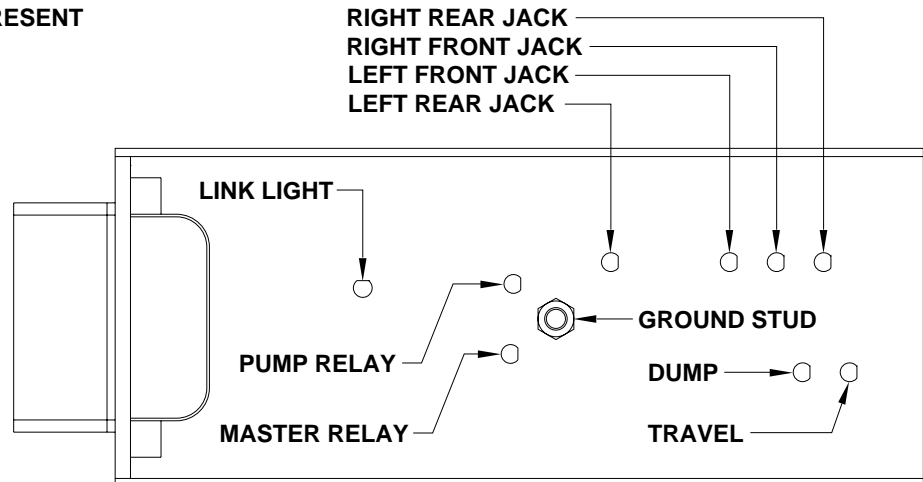

FRONT VIEW OF I/O MODULE CONNECTOR

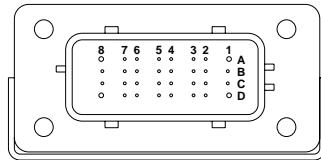

A LIT RED LED INDICATES THERE SHOULD BE +12 VOLTS ON THE CORRESPONDING WIRE.

LINK LIGHT: LINK LIGHT FLASHING INDICATES PROPER COMMUNICATION BETWEEN THE I/O MODULE AND THE TOUCH PANEL. LINK LIGHT ON SOLID OR OFF INDICATES A FAILURE.

PIN #	WIRE COLOR	WIRE NUMBER	WIRE DESCRIPTION AND FUNCTION
A1	(+12 BLACK WIRE 8601)	INPUT WHEN EXTENSION DEVICES ROOMS, GEN SLIDE, STEP COVER ECT. ARE USED	
A2	YELLOW	N/A	CAN HIGH COMMUNICATION WIRE
A3 AND A4			NO CONNECTION
A5	BLACK	2000	SWITCHED GROUND FROM RIGHT FRONT JACK WARNING SWITCH
A6	BLACK	2200	SWITCHED GROUND FROM RIGHT FRONT JACK PRESSURE SWITCH
A7	BLACK	3200	SWITCHED GROUND FROM RIGHT REAR JACK PRESSURE SWITCH
A8	BLACK	8101	SWITCHED GROUND FROM 50 PSI MANIFOLD PRESSURE SWITCH
B1	RED	6800	+12 VOLT POWER TO THE TOUCH PANEL
B2	GREEN	N/A	CAN LOW COMMUNICATION WIRE
B3	WHITE	6230	GROUND TO THE TOUCH PANEL
B4			NO CONNECTION
B5	BLACK	3000	SWITCHED GROUND FROM RIGHT REAR JACK WARNING SWITCH
B6	BLACK	4200	SWITCHED GROUND FROM LEFT REAR JACK PRESSURE SWITCH
B7			NO CONNECTION
B8	BLACK	8100	SWITCHED GROUND FROM 3000 PSI MANIFOLD PRESSURE SWITCH
C1	RED	6121	+12 VOLT POWER FOR LEVEL SENSING UNIT
C2	N/A	N/A	SHIELD WIRE FOR GREEN & YELLOW CAN COMMUNICATION WIRES
C3	WHITE	6231	GROUND FOR LEVEL SENSING UNIT
C4	BLACK	0400	SWITCHED GROUND FROM SENSING UNIT - REAR
C5	BLACK	4000	SWITCHED GROUND FROM LEFT REAR JACK WARNING SWITCH
C6 AND C7			NO CONNECTION
C8	BLACK	0300	SWITCHED GROUND FROM SENSING UNIT - RIGHT SIDE
D1	RED	6120	+12 VOLT ACCESSORY POWER FOR I/O MODULE
D2	WHITE	6235	GROUND FOR JACK WARNING SWITCHES
D3			NO CONNECTION
D4	BLACK	1000	SWITCHED GROUND FROM LEFT FRONT JACK WARNING SWITCH
D5	BLACK	1200	SWITCHED GROUND FROM LEFT FRONT JACK PRESSURE SWITCH
D6	BLACK	0100	SWITCHED GROUND FROM SENSING UNIT - LEFT SIDE
D7	BLACK	0200	SWITCHED GROUND FROM SENSING UNIT - FRONT
D8	BLACK	9000	GROUND FROM PARK BRAKE SWITCH

ELECTRICAL CONNECTION DIAGRAM

LEVELING SYSTEM HYDRAULIC MANIFOLD W/PILOT AIR DUMP PUMP AND MASTER RELAYS

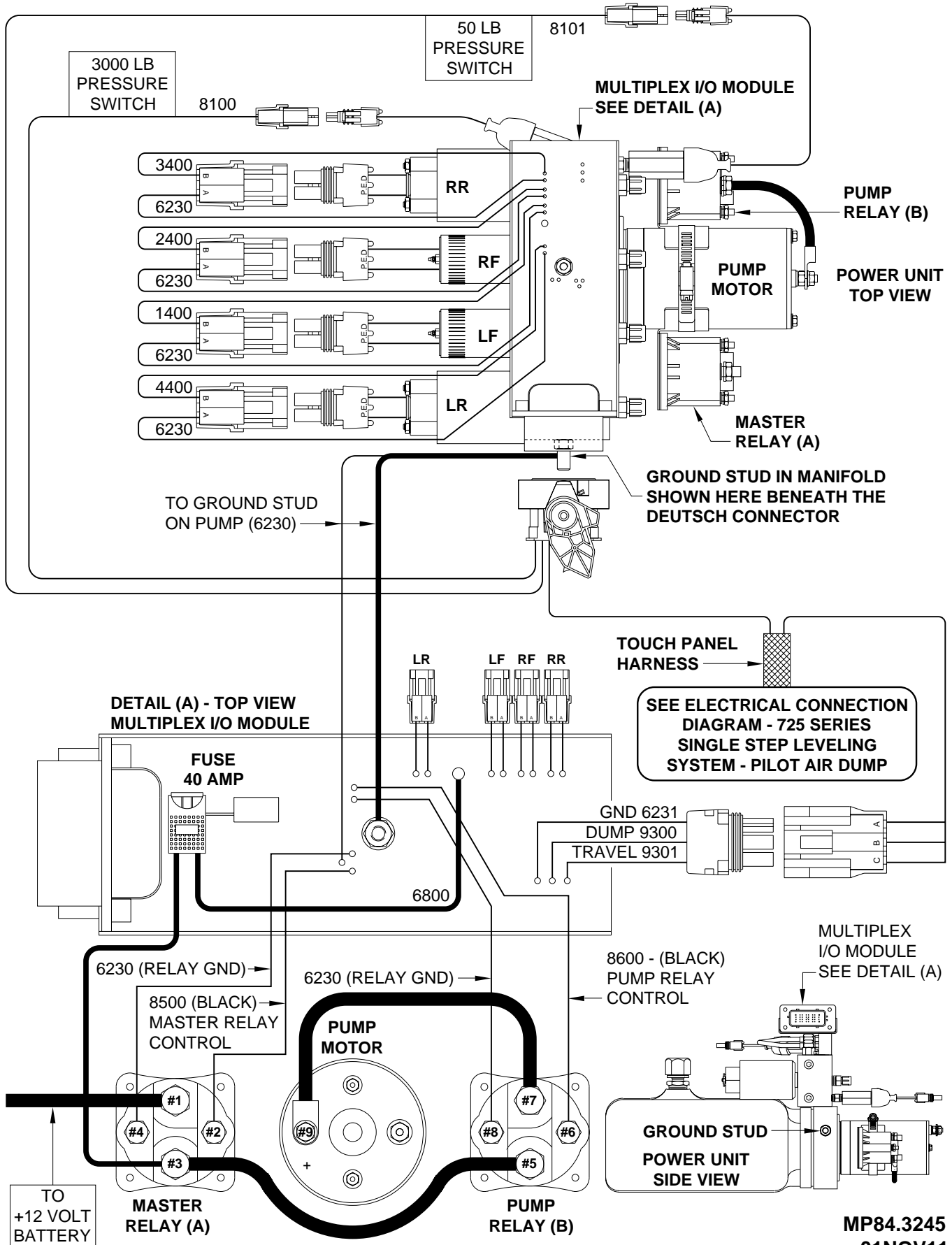

ELECTRICAL CONNECTION DIAGRAM

725 LEVELING SYSTEM

TOUCH PANEL CONNECTIONS

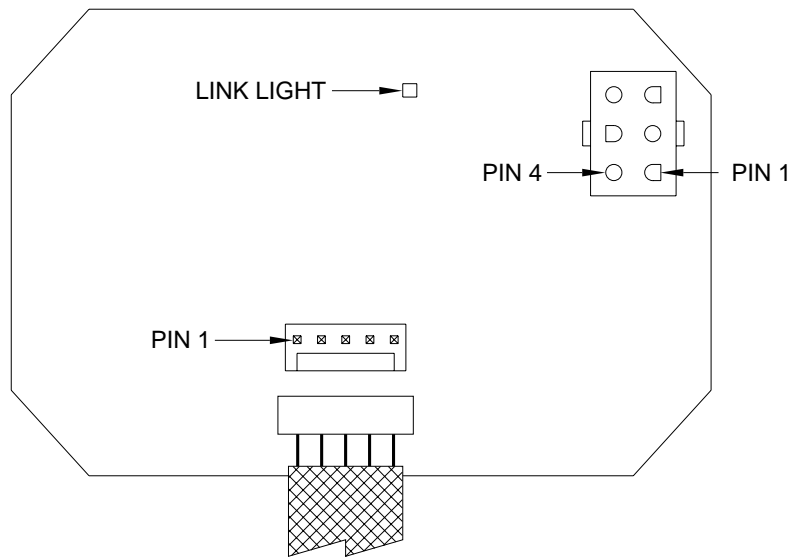
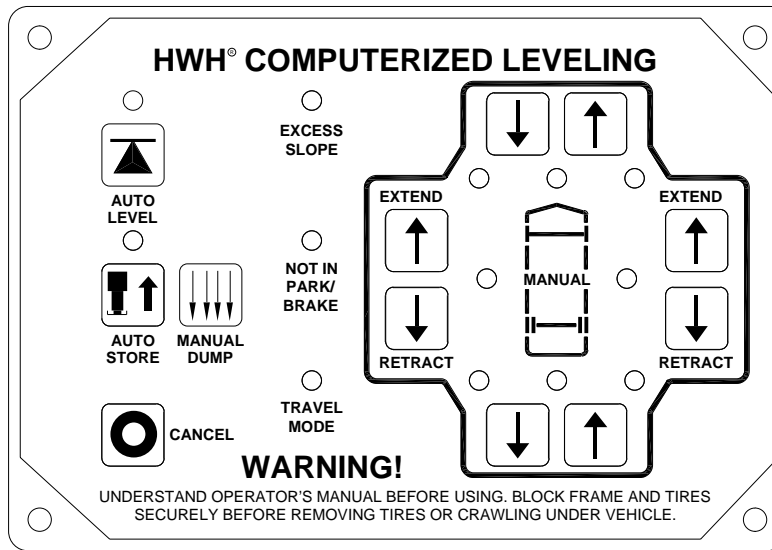

PIN #	WIRE COLOR	WIRE NUMBER	WIRE DESCRIPTION AND FUNCTION
5 PIN MTA CONNECTOR			
1	YELLOW	---	CAN HIGH
2	GREEN	---	CAN LOW
3	---	---	CAN SHIELD
4	WHITE	6230	GROUND FROM CONTROL BOX
5	RED	6800	+12 VOLTS FROM INPUT/OUTPUT MODULE
6 PIN UML CONNECTOR			
1 THRU 4	---	---	NO CONNECTION
5	BLACK	7699	SWITCHED GROUND FOR MASTER WARNING
6	---	---	NO CONNECTION

ELECTRICAL CONNECTION DIAGRAM

LEVEL SENSING UNIT

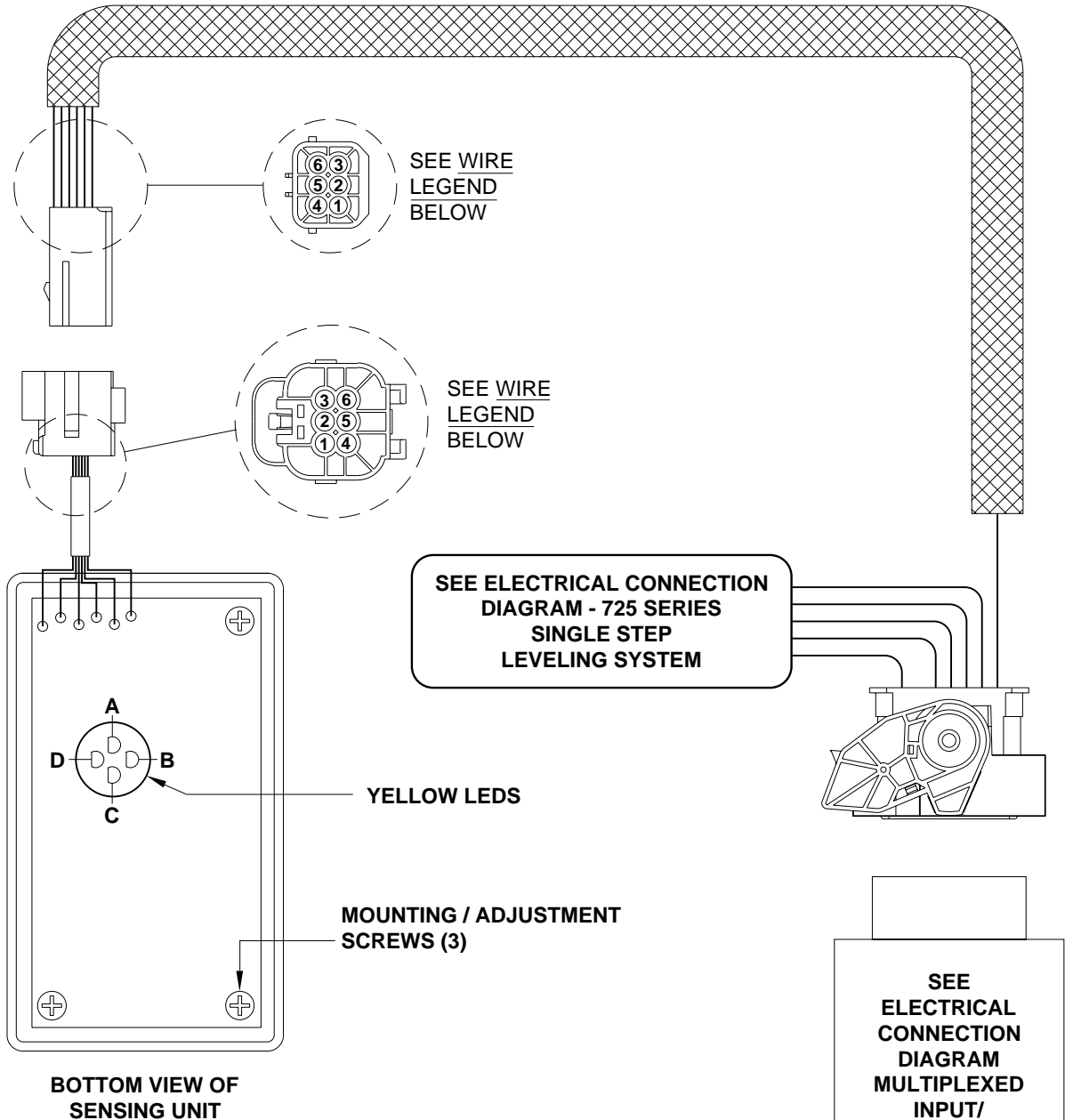

- LED A - FRONT OF VEHICLE
- LED B - LEFT SIDE OF VEHICLE (DRIVER SIDE)
- LED C - REAR OF VEHICLE
- LED D - RIGHT SIDE OF VEHICLE (PASSENGER SIDE)

WIRE LEGEND -

SENSING UNIT PLUG	HARNESS PLUG	
PIN 1 - ORANGE	BLACK - 0400	SWITCHED GROUND WHEN REAR IS LOW
PIN 2 - WHITE - - -	WHITE - 6231	GROUND FROM SENSING UNIT
PIN 3 - RED - - - - -	RED - 6121	+12 VOLT FOR SENSING UNIT
PIN 4 - YELLOW	BLACK - 0100	SWITCHED GROUND WHEN LEFT SIDE IS LOW
PIN 5 - BLACK - - -	BLACK - 0200	SWITCHED GROUND WHEN FRONT IS LOW
PIN 6 - GREEN - -	BLACK - 0300	SWITCHED GROUND WHEN RIGHT SIDE IS LOW

ELECTRICAL CONNECTION DIAGRAM

VOLTAGE TEST INFORMATION

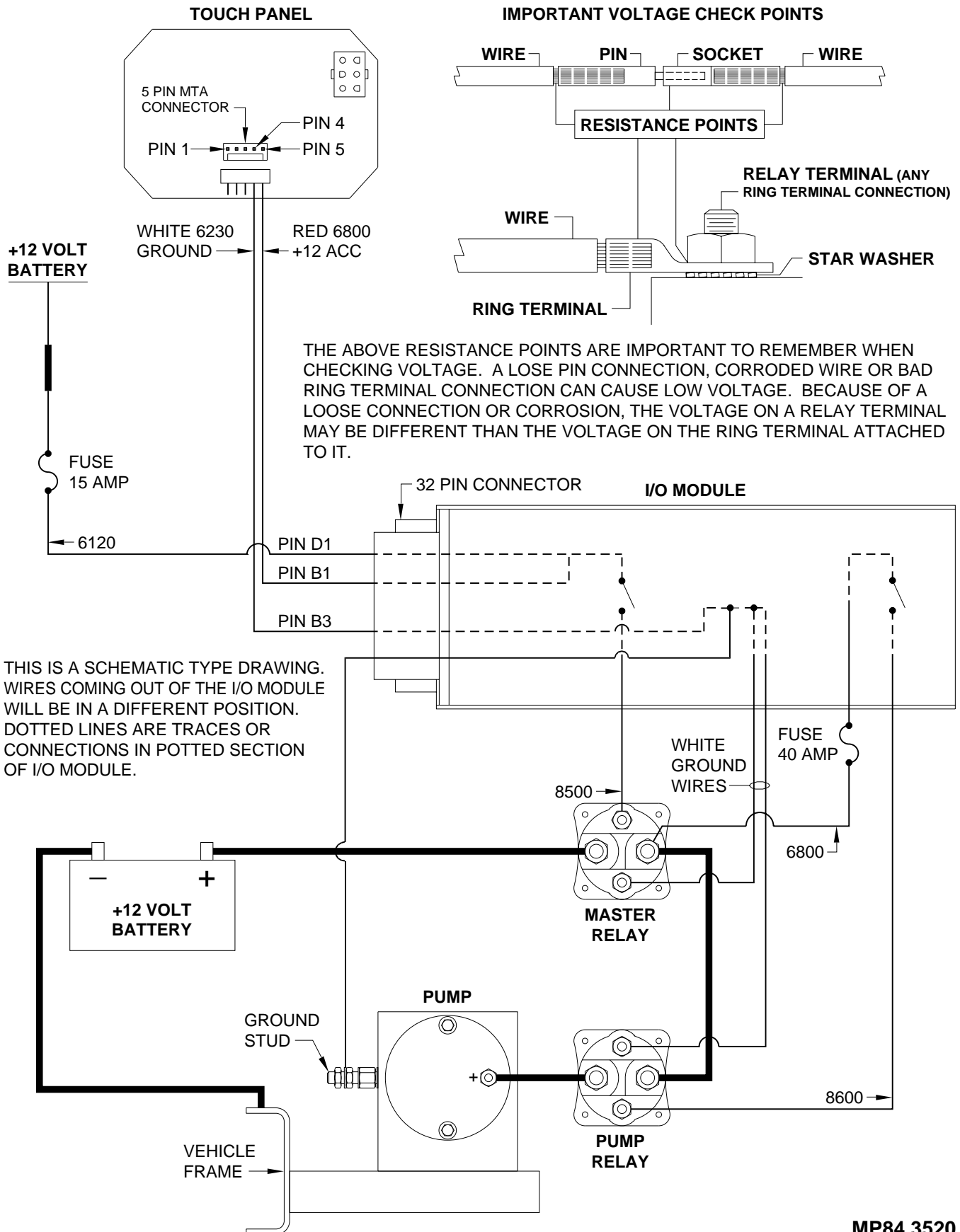

ADJUSTMENT FOR JACK PRESSURE SWITCHES

ADJUSTMENT FOR JACK PRESSURE SWITCHES

The 725 System utilizes a pressure switch on each jack to achieve the proper stabilizing pressure. Each jack should lift the coach 1/2" to 1" when stabilizing the coach. The coach should be leveled in several different positions so that each jack can be checked. These pressure switches are adjustable.

Before adjusting a switch, unplug the wire to prevent the wire from twisting. Loosen the jam nut and use pliers to turn the adjustment body. If a jack needs to lift a little more for stabilizing, turn the adjustment body clockwise. This will increase the pressure. If a jack is lifting too high, turn the adjustment body counterclockwise. This will decrease the pressure. Only turn the adjustment body a half a turn at a time then check the operation of the system. Remember to plug the switch in for the test. Repeat as necessary. When the adjustments are complete, snug the jam nut back down. **DO NOT OVER TIGHTEN.** Hold the adjustment body with pliers to prevent the adjustment body from turning while tightening the jam nut.

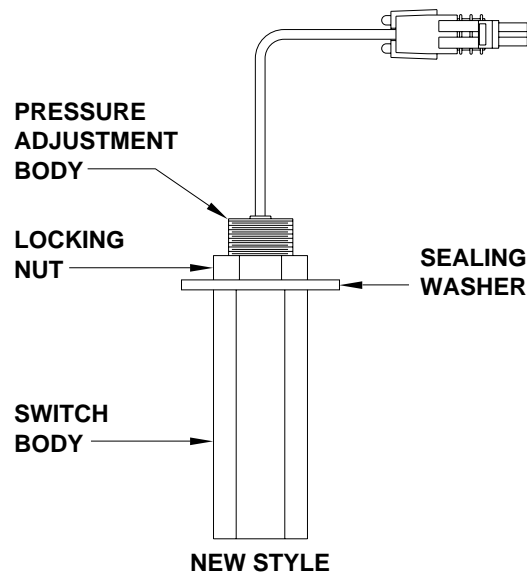

If the jacks or an individual jack comes down but does not touch the ground, do not adjust the level sensor. Adjust the pressure switch(es) as described above.

MASTER LIGHT/BUZZER CONNECTION DIAGRAM

725 SERIES LEVELING SYSTEM

A MASTER WARNING INDICATOR SHOULD ALWAYS BE USED. WHEN THE LEVELING SYSTEM HAS STRAIGHT-ACTING JACKS A WARNING BUZZER MUST BE USED.

NOTE: BY SUPPLYING IGNITION POWER TO THE WARNING BUZZER AND LIGHT, AND "ACC" POWER TO THE TOUCH PANEL, THE SYSTEM MAY BE OPERATED IN ACCESSORY WITHOUT THE BUZZER SOUNDING. THE NEGATIVE SIGNAL FOR THE WARNING INDICATORS MUST ALWAYS COME FROM THE TOUCH PANEL.

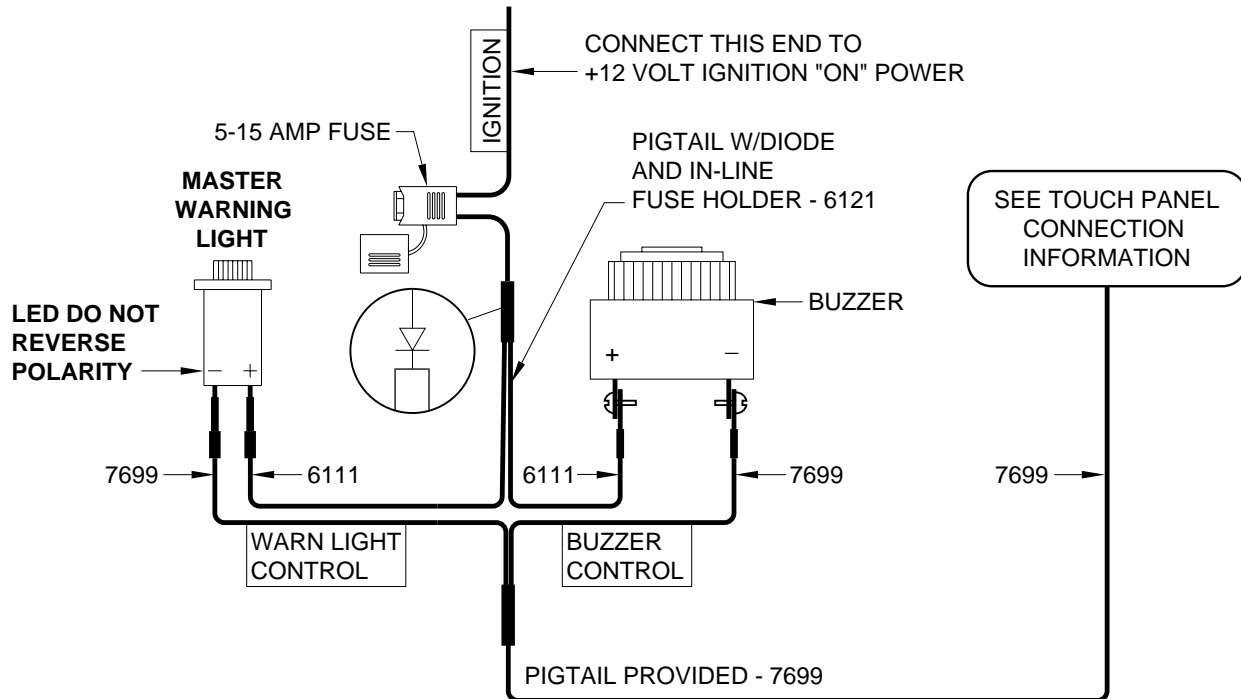

INFORMATION INSERT

HYDRAULIC SOLENOID VALVE

IDENTIFICATION - MANUAL OPERATIONS - REPLACEMENT

REPLACEMENT VALVES MAY HAVE A VALVE RELEASE NUT OR RELEASE CAM

SOLENOID VALVES WITH CAM RELEASE

The cam release style valves are direct replacements for all previous styles of HWH hydraulic solenoid valves.

Valve size and voltage are still factors to be considered when replacing any HWH hydraulic solenoid valve. Replace a small style 12 volt valve with a small style 12 volt valve. Replace a large style 12 volt valve with a large style 12 volt valve. This is true for 24 volt valves also.

Valve installation has not changed, simply turn out the old valve, confirm that no o-ring debris has been left in the manifold block and turn in the new valve.

After installing the valve and without creating stress on the wires at the point where they exit the valve body. Use a wire tie to secure the wires to the valve body to keep the wires from being pinched beneath the cam mechanism during operation.

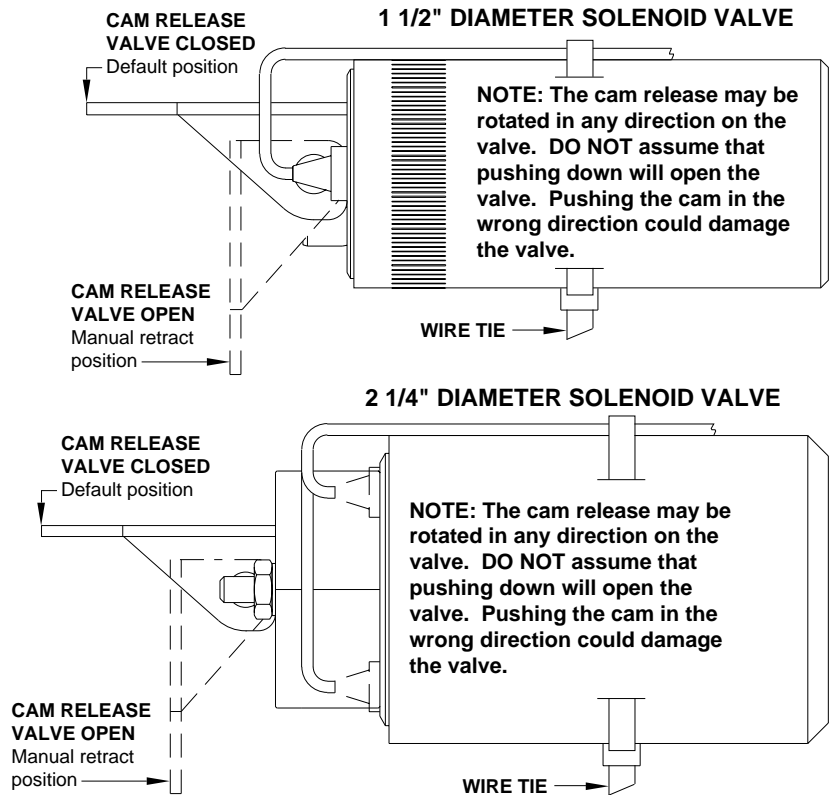

SOLENOID VALVES WITH 1/4" NUT RELEASE

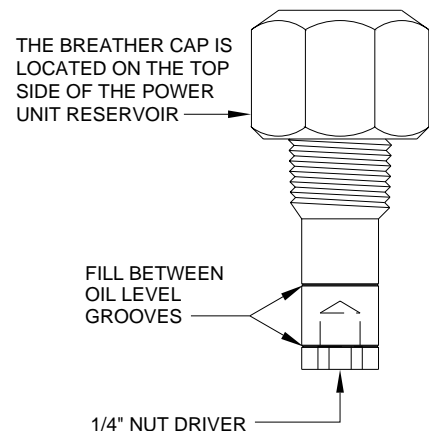
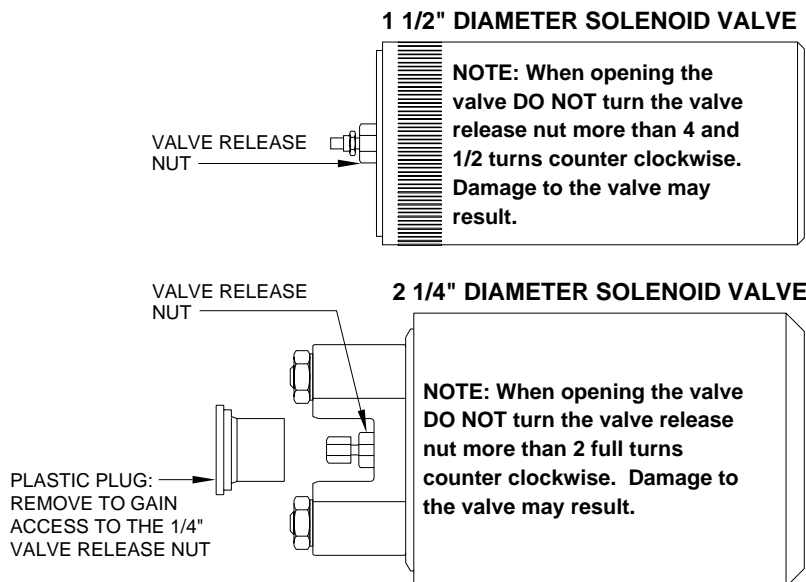

IMPORTANT: PRIOR TO REMOVING THE BREATHER CAP, EITHER TO CHECK THE OIL LEVEL OR TO USE 1/4" NUT DRIVER, CLEAN ANY DEBRIS FROM THE TOP OF THE RESERVOIR. BEFORE RETURNING THE BREATHER CAP TO THE RESERVOIR, REMOVE ANY PAINT CHIPS OR OTHER DEBRIS FROM THE DIPSTICK INCLUDING DEBRIS INSIDE THE 1/4" NUT DRIVER.

725 TROUBLE SHOOTING GUIDE

GLOSSARY

AIR DUMP - PILOT: The pilot operated air dump system is supplied by the chassis manufacturer. This system uses an electronically controlled two position pilot valve that switches the suspension from a travel mode to a dump mode. In the travel mode, the height control valves control the suspension. In the dump mode, the height control valves are isolated from the air bags and the air is exhausted from the air bags. Only the air in the bags is exhausted, the air in the rest of the system remains. The pilot valve has a simple 12 volt coil on each end of the valve. Part of the control harness is supplied by the vehicle manufacturer and the harness from the HWH I/O module is supplied by HWH. There are normally three wires in the HWH harness, a white ground wire, a number 9300 black wire for the dump side and a number 9301 black wire for the travel side of the pilot valve. The HWH I/O module switches +12 volts to control the pilot valve. When power is supplied to either coil on the pilot valve, the valve remains in that position until power is supplied to the other coil.

NOTE: Other types of pilot operated air dump systems may be used such as manually controlled valves, but the above described system is controlled by the HWH leveling system controls.

AIR DUMP VALVE - HWH: The air dump valve is a normally closed valve that is actuated with a 12 volt coil. When power is supplied to the valve, the valve opens to allow air through. When power is removed, the valve is closed with a spring. Although there are different arrangements, the most common is one HWH dump valve for each suspension height control valve. The dump valve is teed into the air line between the height control valve and the suspension air bags. When the dump valves are open, they exhaust all the air from the air bags and the vehicle suspension. Normally the complete harness for this system is supplied by HWH. There are two wires to each valve, a white wire and a black number 9300 wire. The HWH I/O module switches +12 volts to open the air dump valves.

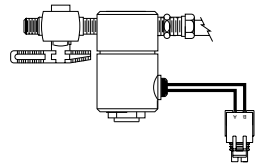

CHECK VALVE - LEVELING SYSTEM HYDRAULIC MANIFOLD: There are two check valves for each solenoid valve. The check valves allow two solenoid valves to be opened at the same time without fluid flowing from one jack to the other. This keeps the vehicle from dropping when one jack is on the ground and another jack is being extended. Although the check valves can be replaced, HWH should be contacted when there are check valve problems.

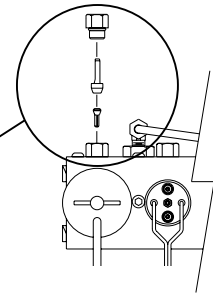

JACK CYLINDER - STRAIGHT-ACTING (PIVOTING JACK) W/SPRING RETRACT: The jack cylinders are hydraulic, single acting cylinders which are used to level and stabilize the vehicle. The cylinders are extended with fluid supplied by the hydraulic pump under pressure. The jacks are retracted by the use of a pair of springs which pull the jack up when it's solenoid valve is open and the pump is not running. Jack cylinders are mounted to the frame of the vehicle in a pivot bracket. The jack cylinder can pivot inboard and outboard slightly when mounted into the jack pivot bracket. The foot of the jack also pivots. The foot is attached to the cylinder with a nut. When a cylinder has a problem such as a leak, only the cylinder should be replaced. The cylinders are available in different capacities, lengths and spring arrangements. The capacities are 4,000#, 6,000#, 9,000#, 12,000#, 16,000# and 24,000#.



JACK - STRAIGHT-ACTING (FIXED MOUNTING) W/SPRING RETRACT: The straight-acting jack is a hydraulic, single-acting cylinder that mounts directly to the frame of the vehicle. The jack cylinder has no pivoting action but the foot does pivot. The foot is attached to the cylinder with a nut. The jack is extended with hydraulic pressure and is retracted with a pair of springs. The Straight Acting jack with a fixed mounting should eventually be available in a full range of capacities 4,000# thru 24,000#.

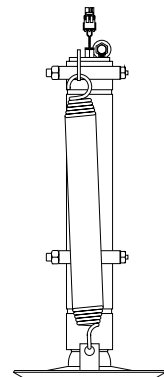

625 TROUBLE SHOOTING GUIDE

GLOSSARY

LEVEL SENSING UNIT: The level sensing unit controls the yellow LEVEL indicators on the touch panel. The sensing unit is mounted in the I/O module. The sensing unit is a rectangular box mounted remote from the multiplexed I/O module. There are 6 wires for the sensing unit: 1 power wire, 1 ground wire and 4 signal wires. The signal wires supply a ground to turn on the yellow level indicator lights. The sensing unit harness connects to the 32 pin I/O module. The sensing unit has 3 mounting screws with a spring at each screw between the sensing unit and mounting surface. The sensing unit is marked for mounting position, "THIS SIDE UP" and an arrow pointing "FRONT". The bottom of the sensing unit has 4 yellow LEDs to assist in adjusting the sensing unit.

NOTE: The level sensing unit has a tolerance for leveling. The vehicle may not always be 100% level and may level somewhat differently when the vehicle is parked in different places. The vehicle should be within approximately 5 inches front to rear and 1 inch side to side when all yellow level lights are out.

MULTIPLEXED INPUT/OUTPUT MODULE (I/O MODULE): The I/O module is mounted to the top of the leveling system hydraulic manifold. The module has one 32 pin latching connector and a group of control and ground wires for solenoid valves, pump relays and air dump equipment. There is also a #10 wire with a 40 amp to provide switched power from the master relay for the solenoid valve outputs. The 32 pin connector contains ignition/acc. power for the module, all inputs from any warning or pressure switches, inputs from the level sensing unit plus power and ground for the sensing unit and the connections for the touch panel harness. The I/O module cannot be repaired and must be replaced with a new module if found to be defective.

MANIFOLD HYDRAULIC: The hydraulic manifold is mounted on top of the pump. The manifold distributes the hydraulic fluid to the jacks as needed to extend the jacks. When retracting jacks the fluid returns to the pump through the manifold. The manifold consists of four solenoid valves, a pair of check valves for each solenoid valve, a 50 p.s.i. pressure switch, a 3000 p.s.i. pressure switch and a shuttle valve. The replaceable parts of the manifold are the solenoid valves, the pressure switches and the shuttle valve. If it is determined a check valve is bad, it may be required to replace the complete manifold. Contact HWH when check valve problems occur.

PRESSURE SWITCH - 3000 P.S.I. MANIFOLD: This pressure switch is a single wire, normally open switch. It is mounted on the leveling system hydraulic manifold. The contacts of this switch will close when the pressure in the manifold reaches 3000 p.s.i. When the contacts of the switch close, this supplies a ground signal to the I/O module. During the leveling mode, if a yellow level light is on and this switch closes, the I/O module will turn the "EXCESS SLOPE" light that is on the touch panel on. The panel will turn off with the "EXCESS SLOPE" light remaining on. The "EXCESS SLOPE" light will be on whenever the ignition is on until the jacks are completely retracted with the "STORE" button or the park brake is released with the ignition on.

PRESSURE SWITCH - 50 P.S.I. MANIFOLD: This pressure switch is a single wire, normally open switch. It is mounted on the leveling system hydraulic manifold. The contacts of this switch will close when the pressure in the manifold reaches 50 p.s.i. When the contacts of the switch close, this supplies a ground signal to the I/O module. The solenoid valves that control the jacks can open when the I/O module sees the ground signal from the 50 p.s.i. switch. If this switch is inoperative, the jack solenoid valves will still function. This switch will not interfere when retracting jacks.

PRESSURE SWITCH - JACK: This pressure switch is a single wire, normally open switch. There is one mounted on each jack. The contacts of this switch close when the pressure the switch is set at is reached. The contacts of this switch, when closed, supply a ground signal to the I/O module. Smaller jacks and replacement switches are set at 140 p.s.i. Larger jacks will be set at a higher pressure. The switches can be adjusted as necessary. The jack pressure switches are used to stabilize the vehicle during the automatic leveling procedure. The jack pressure switches should be adjusted so each jack lifts the vehicle between 1/4 to 3/4 inch after reaching the ground when used to stabilize the vehicle.

NOTE: All hydraulic pressure switches supplied by HWH at this time are manufactured by HWH. These switches all look the same. The switches can be identified by a tag near the Packard connector on the switch wire. The switch part number and the set pressure are listed on the tag.

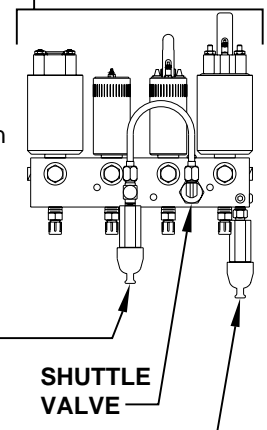
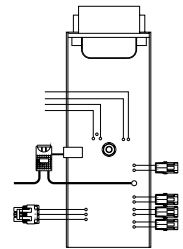
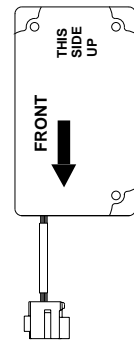

SHUTTLE VALVE

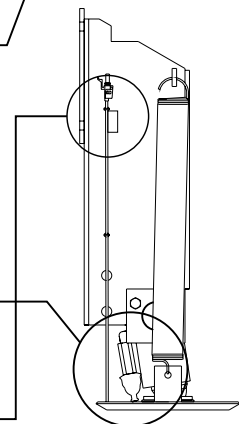

625 TROUBLE SHOOTING GUIDE

GLOSSARY

PUMP: The hydraulic pump supplies fluid to extend the jacks and operate any HWH slide mechanisms. The pump is turned with a +12 volt motor. (Some systems may use a +24 volt motor) The motor is a replaceable part. The pump motor is internally grounded. This requires the pump/manifold assembly to have a good frame ground through the mounting of the assembly. This may require a separate ground cable, minimum size #2, to supply the necessary ground for the assembly. The oil level in the pump reservoir should be checked with all HWH cylinders, leveling jacks and/or slides retracted. The oil level should be (1) inch down from the top of the reservoir fill hole. The pump should not run when the leveling jacks are being retracted. The pump motor does not have thermal protection built into the motor. The correct pump pressure should be 3500 p.s.i. When checking the pump pressure, the minimum pressure should be 3300 p.s.i. and the maximum pressure should be 3600 p.s.i. The pump reservoir is equipped with a breather cap/dipstick that has a 1/4 inch nut driver in the end of the dipstick to manually open solenoid valves with valve release nuts. The reservoir has to be vented and should never be plugged tight.

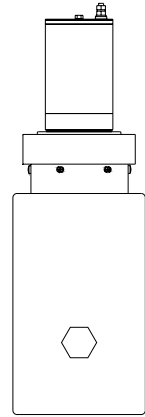

NOTE: There are several different size pump motors used along with a range of different tank capacities. Also, a few pumps have a relief set at a lower pressure. Due to mounting and operational requirements, it is important to obtain the proper replacement components or complete unit.

RELAY - MASTER: The master relay is a continuous duty, normally open, four post relay that consists of one pair of contacts and a coil. The contacts are used to switch +12 volts to the pump relay and to the control box. Power in and power out on the contacts can be reversed. The coil is a +12 coil. There is a small post on the relay for each side of the coil. Either post can be +12 volts with the other post being ground. The control box switches +12 volts to turn the relay on. With the relay turned on, the contacts will close supplying +12 volts to the pump relay and the control box. With the relay off, there should be power on one of the large posts only. With the relay on, the voltage on both large posts should be the same. With the relay off, both sides of the relay coil, the small posts, should show a ground. With the relay on, one small post should show +12 volts, the other small post should show ground. If the ground is missing, both small posts will show +12 volts. The master relay will be on whenever the ignition is on and the park brake is set or while a room control switch is being pushed to EXTEND or RETRACT with the park brake set.

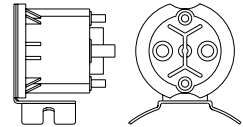

RELAY - PUMP: The pump relay is an intermittent duty, normally open, four post relay that consists of one pair of contacts and a coil. The contacts are used to switch +12 volts to the pump motor. Power in and power out on the contacts can be reversed. The coil is a +12 coil. There is a small post on the relay for each side of the coil. Either post can be +12 volts with the other post being ground. The control box switches +12 volts to turn the relay on. With the relay turned on, the contacts will close supplying +12 volts to the pump motor. With the relay off, there should be power on one of the large posts only. With the relay on, the voltage on both large posts should be the same. With the relay off, both sides of the relay coil, the small posts, should show a ground. With the relay on, one small post should show +12 volts, the other small post should show ground. If the ground is missing, both small posts will show +12 volts.

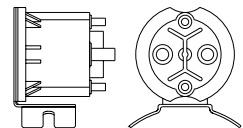

SHUTTLE VALVE: The shuttle valve is located on the leveling system hydraulic manifold. (See MANIFOLD HYDRAULIC) Fluid flows from the pump to the manifold, through a fitting on top of the manifold, through a U shaped tube to a fitting on top of the shuttle valve, then into the manifold to extend the jacks. The fluid flows from the manifold through the shuttle valve back to the pump when retracting the jacks. The shuttle valve is a hydraulically actuated valve. When the pump is running, the shuttle valve shifts to allow the the fluid into the manifold. At the same time, the shuttle valve closes the path for fluid return to the pump. It takes approximately 800 p.s.i. to shift the shuttle valve. When the pump shuts off, the shuttle valve should shift back to the off position. This will allow fluid to flow from the manifold to the pump when the jacks are retracted. The shuttle valve is a replaceable part.

