



**2026  
2041  
Skid-Steer  
Loaders**

**Operator's  
Manual**

**#917179/CP0107**



**Mustang Manufacturing Company, Inc.  
1880 Austin Road, P.O. Box 547  
Owatonna, MN 55060-0547 USA**



Mustang Manufacturing Company, Inc., in cooperation with the American Society of Agricultural Engineers and the Society of Automotive Engineers, has adopted this Safety Alert Symbol to pinpoint precautions which, if not properly followed, can create a safety hazard. When you see this symbol in this manual or on the machine itself, you are reminded to **BE ALERT!** Your personal



Operators must have instructions before running the machine. Untrained operators can cause injury or death.

WRONG

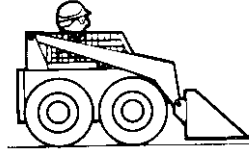

Never use loader without ROPS/FOPS. Never modify the ROPS/FOPS structure.

WRONG

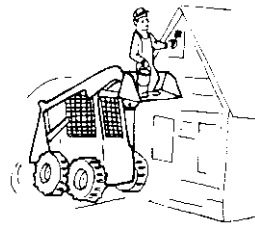

Never use the loader to lift personnel.

CORRECT



Read Operator's Manual before using machine.

WRONG

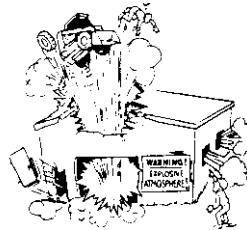

Do not use loader around explosive dust or gas, or where exhaust can contact flammable material.

CORRECT

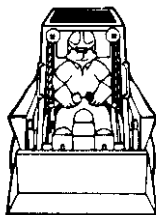

Always fasten seatbelt snugly. Always keep feet on the floor/pedals when operating loader.

# 2026 and 2041 Skid-Steer Loader Operator's Manual

---

## TABLE OF CONTENTS

Introduction . . . . .	1
Safety . . . . .	5
Controls and Safety Equipment . . . . .	17
Operation . . . . .	31
Service . . . . .	41
Troubleshooting . . . . .	57
Maintenance Schedule . . . . .	67
Specifications . . . . .	71
Table of Common Materials and Densities . . . . .	76
Torque Specifications . . . . .	79
Warranty . . . . .	80
Index . . . . .	81

<b>Loader Model Number</b>	
<b>Loader Serial Number</b>	
<b>Engine Serial Number</b>	

All-Tach™ and Hydraloc™ are trademarks of Gehl Company.

## Notes

---

# CHAPTER 1

## INTRODUCTION

This Operator's Manual gives the owner/operator information about maintaining and servicing 2026 and 2041 skid-steer loader models. More importantly, this manual provides an operating plan for safe and proper use of the machine. Major points of safe operation are detailed in the *Safety* chapter of this manual.

We ask that you read and understand the contents of this manual completely and become familiar with your new machine before operating it. See your authorized Mustang dealer if you have any questions concerning information in the manual, require extra manuals or for information concerning the availability of manuals in other languages.

Throughout this manual information is provided set in *italic* type and introduced by the word **Note** or **Important**. Read carefully and comply with those messages – it will improve your operating and maintenance efficiency, help avoid breakdowns and damage, and extend your machine's life.

A manual storage box in the operator's compartment holds the Operator's Manual and AEM Safety Manual (also available in Spanish). Please return the manuals to this box and keep them with the unit at all times. If this machine is resold, we recommend that these manuals be given to the new owner.

The attachments and equipment available for use with this machine have a wide variety of potential applications. Read the manual provided with the attachment to learn how to safely maintain and operate the equipment. Be sure the machine is suitably equipped for the type of work to be performed.

Do not use this machine for any applications or purposes other than those described in this manual or applicable for approved attachments. If the machine is to be used with special attachments or equipment other than those approved by Mustang Manufacturing, consult your Mustang dealer. Any person using non-approved attachments or making unauthorized modifications is responsible for the consequences.

The Mustang dealership network stands ready to provide you with any assistance you may require, including providing genuine Mustang service parts. All service parts should be obtained from your Mustang dealer. Provide complete information about the part and include the model and serial numbers of your machine. Record these numbers in the space provided on the Table of Contents page, as a handy reference.

Please be aware that Mustang strives to continuously improve its products and reserves the right to make changes and improvements in the design and construction of any part without incurring the obligation to install such changes on any unit previously delivered.

## Loader Identification

---

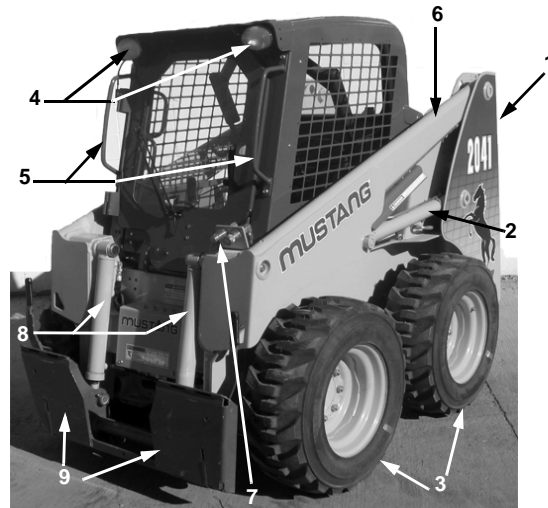



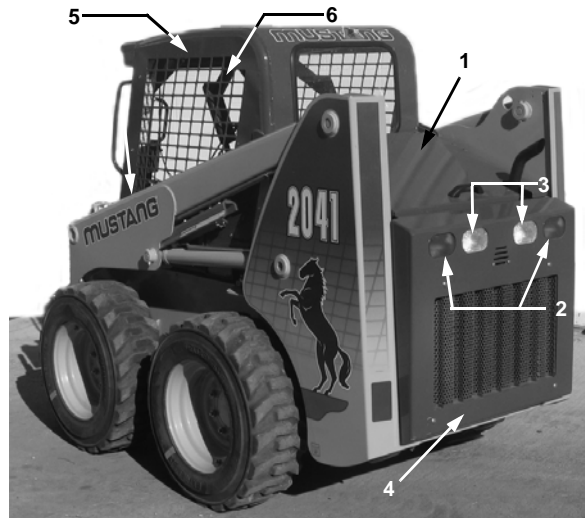











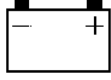





















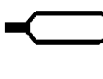
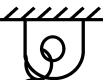



- |                      |                                 |
|----------------------|---------------------------------|
| 1. Upright           | 6. Lift Arm                     |
| 2. Lift Cylinder     | 7. Auxiliary Hydraulic Couplers |
| 3. Tires             | 8. Tilt Cylinders               |
| 4. Front Work Lights | 9. Attachment Bracket           |
| 5. Handholds         |                                 |



- |                     |  |
|---------------------|--|
| 1. Engine Cover     | 5. Roll-Over/Falling Object Protective Structure (ROPS/FOPS) |
| 2. Tail Lights      | 6. Restraint Bar   |
| 3. Rear Work Lights |  |
| 4. Rear Door        |  |

## Control/Indicator Symbols

 Power Off	 Power On	 Engine Start	 Hazard Flasher	 Worklight
 Worklight w/Flasher	 Battery Charge	 Parking Brake	 Read Operator's Manual	 Horn
 Volume - Full	 Volume - Half Full	 Volume - Empty	 Pre-Heat	 Diesel Fuel
 Lift Point	 Neutral	 Safety Alert	 Chaincase Oil	 Seatbelt - Lap Only
 Engine Air Filter	 Engine Oil	 Engine Oil Filter	 Engine Oil Pressure	 Fuel Filter
 Engine Coolant Temperature	 Hydraulic System	 Hydraulic Oil Temperature	 Hydraulic Oil Filter	 Grease Lubrication Point
 Tie-Down	 Machine Travel - Forward	 Machine Travel - Reverse	 Clockwise Rotation	 Counterclockwise Rotation
 Fast	 Slow	 Bucket - Lower	 Bucket - Raise	 Bucket - Float
 Bucket - Rollback	 Bucket - Dump			

## Notes

---



## CHAPTER 2

### SAFETY

 This safety alert symbol means Attention! Become alert! Your safety is involved! It stresses an attitude of “Heads Up for Safety” and can be found throughout this Operator’s Manual and on the decals on the machine.

Before operating this machine, read and study the following safety information. For further reference on the safe operation of skid-steer loaders, Mustang Manufacturing Company suggests that equipment owners obtain the Mustang “Skid-Steer Loader Safety” video, which is available through Mustang dealers. In addition, be sure that everyone who operates or works with this machine, whether family member or employee, is familiar with these safety precautions. It is essential to have competent and careful operators, who are not physically or mentally impaired, and who are thoroughly trained in the safe operation of the machine and the handling of loads. It is recommended that the operator be capable of obtaining a valid motor vehicle operator’s license.

The use of skid-steer loaders is subject to certain hazards that cannot be eliminated by mechanical means, but only by exercising intelligence, care and common sense. Such hazards include, but are not limited to, hillside operation, overloading, instability of the load, poor maintenance and using the equipment for a purpose for which it is not intended or designed.

Mustang Manufacturing Company ALWAYS considers the operator’s safety when designing its machinery, and guards exposed moving parts for the operator’s protection. However, some areas cannot be guarded or shielded in order to assure proper operation. Furthermore, this Operator’s Manual and decals on the machine warn of additional hazards and they should be read and observed closely.

Some photographs in this manual may show doors, guards and shields open or removed for illustrative purposes only. Be sure that all doors, guards and shields are in their proper operating positions before starting the engine to operate the unit.

Different applications may require optional safety equipment, such as a back-up alarm, mirror, strobe light or an impact-resistant front door. Be sure you know the job site hazards and equip your machine as needed.

 **DANGER** “DANGER” indicates an imminently hazardous situation which, if not avoided, will result in death or serious injury.

 **WARNING** “WARNING” indicates a potentially hazardous situation which, if not avoided, could result in death or serious injury.

 **CAUTION** “CAUTION” indicates a potentially hazardous situation which, if not avoided may result in minor or moderate injury. May also alert against unsafe practices.

## **Mandatory Safety Shutdown Procedure**

---

Before cleaning, adjusting, lubricating, servicing the unit, or leaving it unattended:

1. Move the drive control handle(s) to the neutral position.
2. Lower the lift arm and attachment completely. If the lift arm *must* be left in the raised position, BE SURE to properly engage the lift arm support device (page 20).
3. Move the throttle to the low idle position, shut off the engine and remove the key.
4. Before exiting, move the lift/tilt control(s) to verify that the controls do not cause movement of the lift arm or attachment.

## **Safety Reminders**

---

### **Before Starting**

- Do not modify the ROPS/FOPS unless instructed to do so in installation instructions. Modifications such as welding, drilling or cutting can weaken the structure and reduce the protection it provides. A damaged ROPS/FOPS cannot be repaired – it must be replaced.
- To ensure safe operation, replace damaged or worn-out parts with genuine Mustang service parts.
- Mustang skid-steer loaders are designed and intended to be used only with Mustang attachments or approved referral attachments. Mustang Manufacturing Company cannot be responsible for operator safety if the loader is used with a non-approved attachment.
- Remove all trash and debris from the machine each day, especially in the engine compartment, to minimize the risk of fire.
- Always face the loader and use the handholds and steps when getting on and off the loader. Do not jump off the loader.
- Never use starting fluid (ether).
- Walk around the machine and warn all nearby personnel before starting the machine.
- Always perform a daily inspection of the machine before using it. Look for damage, loose or missing parts, leaks, etc.

## During Operation

- Machine stability is affected by: the load being carried, the height of the load, machine speed, abrupt control movements and driving over uneven terrain. **DISREGARDING ANY OF THESE FACTORS CAN CAUSE THE LOADER TO TIP, THROWING THE OPERATOR OUT OF THE SEAT OR LOADER, RESULTING IN DEATH OR SERIOUS INJURY.** Therefore: ALWAYS operate with the seatbelt fastened and the restraint bar lowered. Do not exceed the machine's Rated Operating Load. Carry the load low. Move the controls smoothly and gradually, and operate at speeds appropriate for the conditions.
- When operating on inclines or ramps, always travel with the heavier end of the loader toward the top of the incline for additional stability.
- Do not raise or drop a loaded bucket or fork suddenly. Abrupt movements under load can cause serious instability.
- Never activate the float function with the bucket or attachment loaded or raised, because this will cause the arm to lower rapidly.
- Do not drive too close to an excavation or ditch; be sure that the surrounding ground has adequate strength to support the weight of the loader and the load.
- Never carry riders. Do not allow others to ride on the machine or attachments, because they could fall or cause an accident.
- Always look to the rear before backing up the skid-steer loader.
- Operate the controls only from the operator's seat.
- Always keep hands and feet inside the operator's compartment while operating the machine.
- New operators must operate the loader in an open area away from bystanders. Practice with the controls until the loader can be operated safely and efficiently.
- Always wear safety goggles, ear and head protection while operating the machine. Operator must wear protective clothing when appropriate.
- Exhaust fumes can kill. Do not operate this machine in an enclosed area unless there is adequate ventilation.
- When you park the machine and before you leave the seat, check the restraint bar for proper operation. The restraint bar, when raised, deactivates the lift/tilt controls and auxiliary hydraulics, and applies the parking brake.

## Maintenance

- Never attempt to by-pass the keyswitch to start the engine. Use only the jump starting procedure detailed in the *Operation* chapter of this manual.
- Never use your hands to search for hydraulic fluid leaks. Instead, use a piece of paper or cardboard. Escaping fluid under pressure can be invisible and can penetrate the skin and cause serious injury. If any fluid is injected into your skin, see a doctor at once. Injected fluid must be surgically removed by a doctor or gangrene may result.

- Always wear safety glasses with side shields when striking metal against metal. In addition, it is recommended that a softer (chip-resistant) material be used to cushion the blow. Failure to heed could lead to serious injury to the eyes or other parts of the body.
- Do not smoke or have any spark-producing equipment in the area while filling the fuel tank or while working on the fuel or hydraulic systems.

## Potential Hazards

---

A skid-steer loader operator must ALWAYS be conscious of the working environment. Operator actions, environmental conditions and the job being done require the full attention of the operator so that safety precautions can be taken.

ALWAYS maintain a safe distance from electric power lines and avoid contact with any electrically charged conductor or gas line. Accidental contact or rupture can result in electrocution or an explosion. Contact the North American One-Call Referral System at: 1-888-258-0808 for the local “Digger’s Hotline” number or the proper local authorities for utility line locations BEFORE starting to dig!

Exposure to crystalline silica (found in sand, soil and rocks) has been associated with silicosis, a debilitating and often fatal lung disease. A Hazard Review (Pub. No. 2002-129) by the U.S. National Institute for Occupational Safety and Health (NIOSH) indicates a significant risk of chronic silicosis for workers exposed to inhaled crystalline silica over a working lifetime. NIOSH recommends an exposure limit of 0.05 mg/m<sup>3</sup> as a time-weighted average for up to a 10-hr workday during a 40-hr workweek. NIOSH also recommends substituting less hazardous materials when feasible, using respiratory protection and regular medical examinations for exposed workers.

## Safety Decals

---

The skid-steer loader has decals that provide safety information and precautions around the loader. These decals must be kept legible. If missing or illegible, they must be replaced promptly. Replacements can be obtained from your Mustang dealer. New equipment must have all decals specified by the manufacturer affixed in their proper locations.

## New Decal Application

Surfaces must be free of dirt, dust, grease and foreign material before applying the decal. Remove the smaller portion of the decal backing paper and apply the exposed adhesive to the clean surface, maintaining proper position and alignment. Peel the rest of the backing paper and apply hand pressure to smooth out the decal surface. Refer to the following pages for proper decal locations. Text decals begin on page 9; no-text decals begin on page 12.

## Safety Decals inside the ROPS/FOPS



137628 – Located on manual box, operator's right

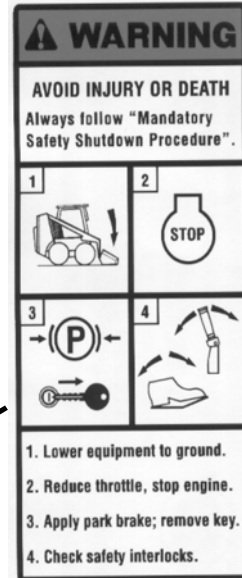

137683 – Located on ROPS left panel



137647 – Located on operator's lower left side

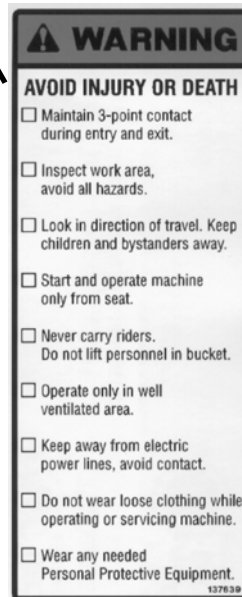

137639 – Located on ROPS left panel

## Safety Decals on the outside of the Skid Loader

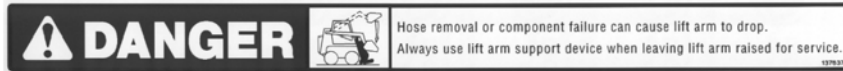

137637 – Lift arm support device, loader left side

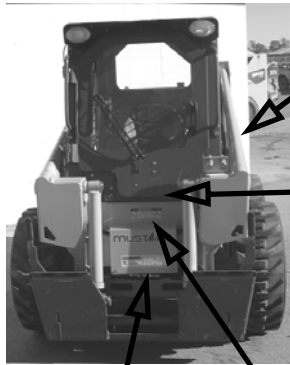

184214 – Under ROPS



137655 – Front of loader



137720 – Front of loader

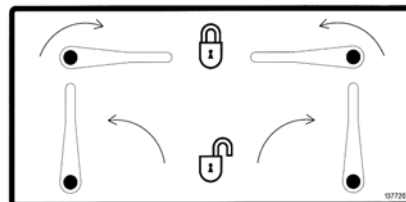

## Safety Decals in the Engine Compartment

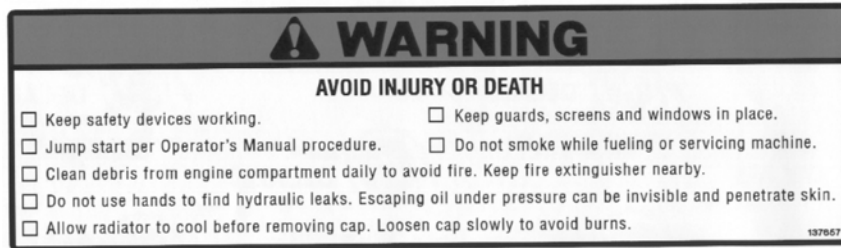

137657 – Right of hydraulic filter

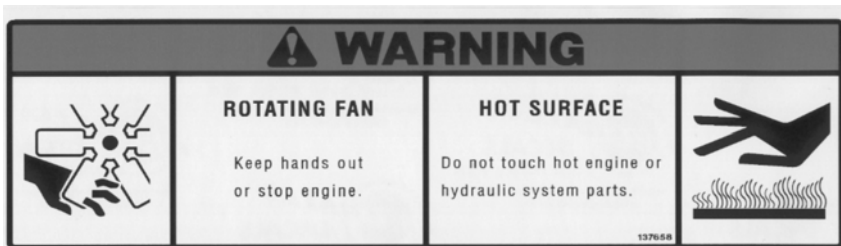
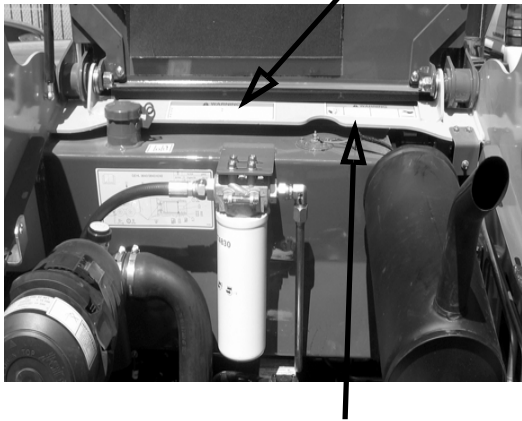

137658 – On radiator

## ISO-Style (used Internationally) Safety Decals inside the ROPS/FOPS



**137842 – Located on manual storage box**

Safety alert: Read Operator's Manual and all safety signs before using machine. The owner is responsible to ensure all users are instructed on safe use and maintenance.



Safety alert: Always follow "Mandatory Safety Shutdown Procedure" in Operator's Manual.

- 1 – Lower equipment to ground.
- 2 – Reduce throttle, stop engine.
- 3 – Apply parking brake; remove key.
- 4 – Check safety interlocks.

**137847 – Part of left instrument panel**

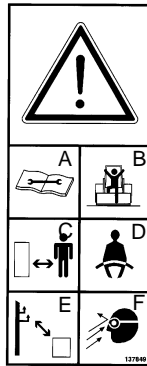
**Safety alert:**

- A** – Check machine before operating; Service per Operator's Manual. Contact dealer (or manufacturer) for information and service parts.
- B** – Maintain 3-point contact during entry and exit.
- C** – Inspect work area. Avoid all hazards. Look in direction of travel. Keep children and bystanders away.
- D** – Start and operate machine only from seat.
- E** – Keep away from power lines; avoid contact.
- F** – Wear any needed Personal Protective Equipment. Do not wear loose clothing while operating or servicing machine.

**137849 – Part of left instrument panel**

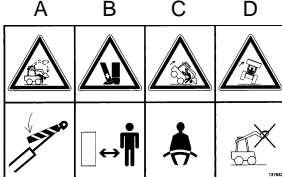

**137843 – Located on operator's lower left side**







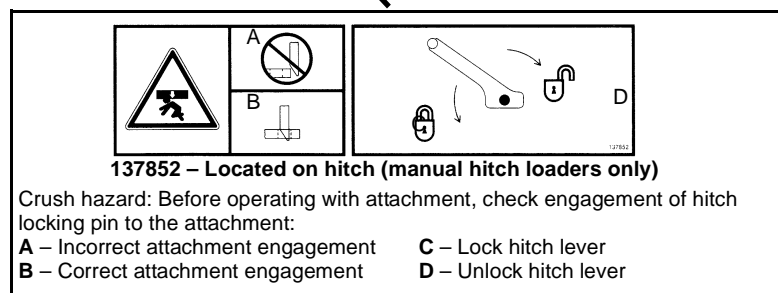
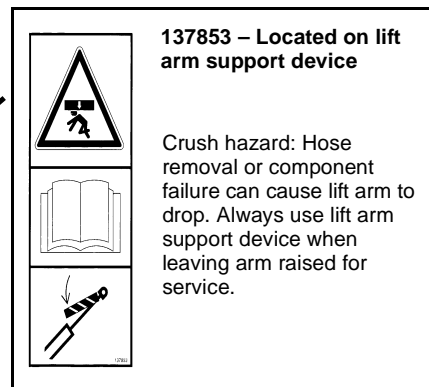
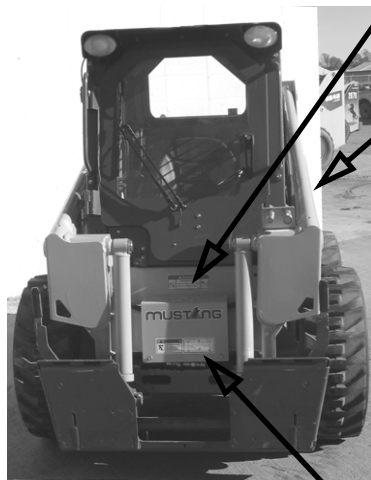
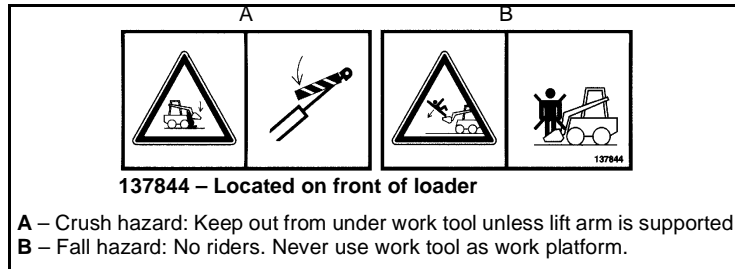



- A** – Crush hazard: Keep out from under lift arm unless lift arm is supported.
- B** – Crush hazard: Keep hands, feet and body inside cab when operating.
- C** – Forward tip hazard: Fasten seat belt. Carry load low. Do not exceed Rated Operating Load.
- D** – Side tip hazard: Avoid steep slopes and high speed turns. Travel up and down slopes with heavy end uphill.



## ISO-Style (used Internationally) Safety Decals on the outside of the Skid-Steer Loader

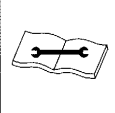

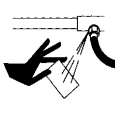
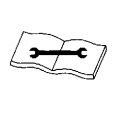

## ISO-Style (used Internationally) Safety Decals in the Engine Compartment

A	B	C	D	E	F
					
					

137845

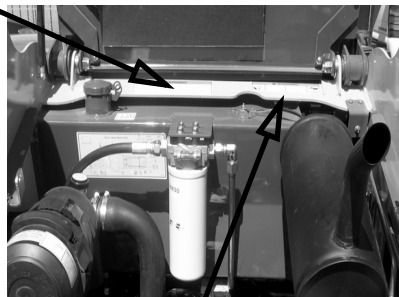
**137845 – Located on cross member for frame**  
**A** – Safety alert: Keep safety devices in place and in working order. Keep guards, screens and windows in place.  
**B** – Fire hazard: Do not smoke while fueling or servicing machine. Clean debris from engine compartment daily to avoid fire. Keep fire extinguisher nearby.  
**C** – Run-over hazard: Jump-start per Operator’s Manual procedure.  
**D** – Oil injection hazard: Do not use hands to find hydraulic leaks. Escaping oil under pressure can be invisible and penetrate skin. Use a piece of cardboard to find leaks.  
**E** – Burn hazard: Allow radiator to cool before removing cap. Loosen cap slowly to avoid burns.  
**F** – Suffocation hazard: Operate only in a well-ventilated area.

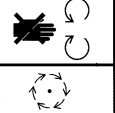
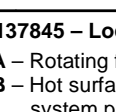
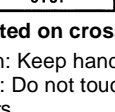

A	B
	
	

137845

**137845 – Located on cross member for frame**  
**A** – Rotating fan: Keep hands out or stop engine.  
**B** – Hot surface: Do not touch hot engine or hydraulic system parts.

## Product and Component Plate Locations

---

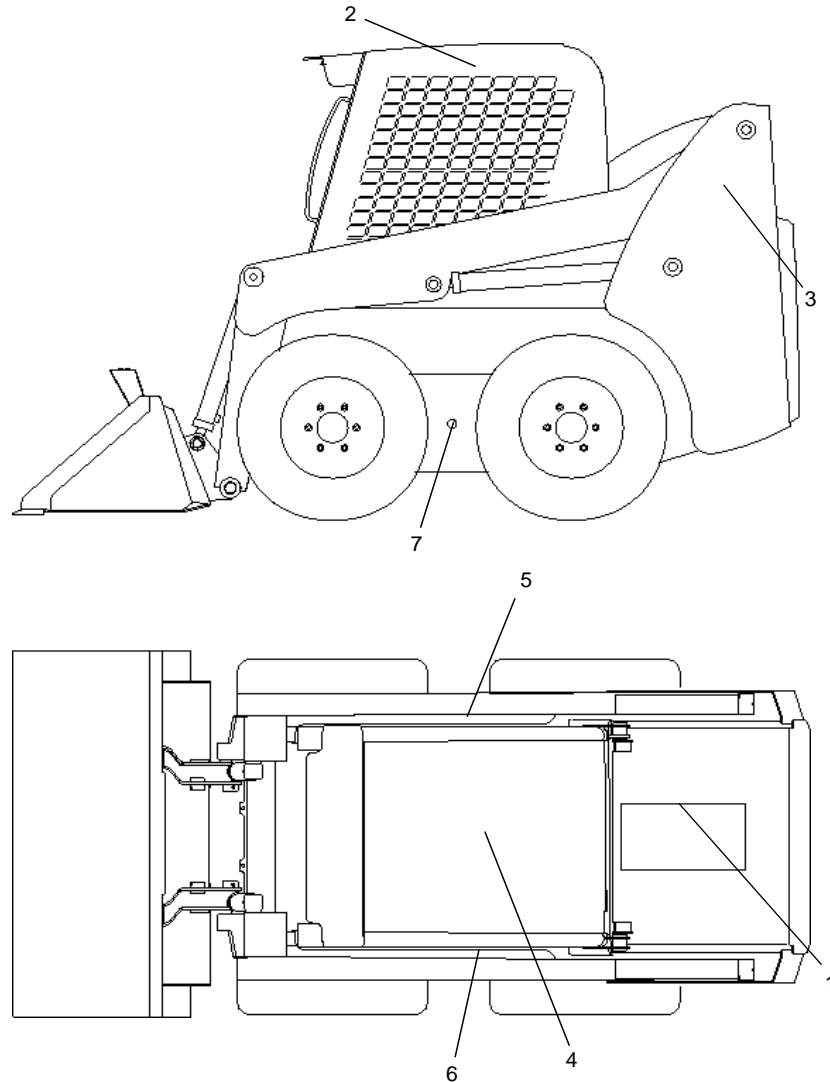

### Product and Component Plates

1. Engine plate: with e.g. type designation, product and serial number
2. Operator protective system plate: with e.g. model, certification and operator protection system serial number
3. Product plate: with Product Identification Number and e.g. model/type designation
4. Seat plate according to ISO 7096
5. Component plate rear drive axle: with e.g. product and serial number
6. Component plate front drive axle: with e.g. product and serial number
7. Component plate transmission: with e.g. product and serial number

## Notes

---

## CHAPTER 3

### CONTROLS AND SAFETY EQUIPMENT

 **CAUTION** Become familiar with and know how to use all safety devices and controls on the skid-steer loader before operating it. Know how to stop loader operation before starting it. This Mustang loader is designed and intended to be used only with a Mustang attachment or a Mustang-approved referral attachment or accessory. Mustang cannot be responsible for operator safety if the loader is used with a non-approved attachment.

#### Guards and Shields

---

Whenever possible and without affecting loader operation, guards and shields are provided to protect against potentially hazardous areas. In many places, safety decals are also provided to warn of potential hazards and/or to display special operating procedures.

 **WARNING** Read and thoroughly understand all safety decals on the loader before operating it. Do not operate the loader unless all factory-installed guards and shields are properly secured in place.

#### Operator Restraint Bar

---

Lower the restraint bar after entering the operator's compartment. The restraint bar is securely anchored to the ROPS. The restraint bar switch is wired in series with the seat switch forming an interlock for the lift arm, tilt, drive and starter circuits (refer to the *Safety Interlock System* topic on page 18 for more information).

 **WARNING** Never defeat the operator restraint bar or seat switch electrically or mechanically. Always wear your seatbelt.

## Operator's Seat

---

The seat is mounted on rails for backward or forward repositioning. A spring-loaded latch handle activates the seat adjustment mechanism.

Suspension seat (optional): A weight adjustment knob is provided with this seat for operator comfort.

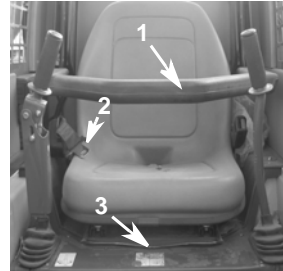

**Figure 1 Operator's Seat**

1. Restraint Bar
2. Seatbelt
3. Seat Adjustment Lever

## Upper-Torso Restraint

---

**⚠ WARNING** ALWAYS wear the upper-torso restraint when operating skid-steer.

The seat belt should always be fastened during operation.

**Important:** *Inspect the seat belt(s) for damage before use, and replace if damaged. Keep seatbelt(s) clean. Use only soap and water to wash seat belt(s). Cleaning solvents can cause damage to seatbelts.*

## Safety Interlock System

---

**⚠ WARNING** NEVER defeat the safety interlock system by mechanically or electrically bypassing any switches, relays or solenoid valves.

An interlock system is used on the loader for operator safety. Together with solenoid valves, switches and relays, the interlock system:

- Prevents the engine from starting unless the operator is sitting on the seat and the operator restraint bar is down.
- Disables the lift arm, attachment tilt and wheel drives when the operator leaves the seat, turns the keyswitch to OFF or raises the restraint bar.
- Disables auxiliary hydraulic system when the restraint bar is raised or the keyswitch is OFF.

## Testing the Safety Interlock System

Before leaving a parked machine, check the safety interlock system for proper operation:

### Restraint Bar

With the engine running, raise the restraint bar. Move each of the controls. There should be not more than a slight movement of the lift arm, attachment and machine. If there is any significant movement, troubleshoot and correct the problem immediately. Contact your dealer if necessary.

### Seat Switch

With the engine off and the restraint bar lowered, unfasten the seatbelt. Lift your weight up off the seat. Try to start the engine. If the engine starts, turn off the engine, and troubleshoot and correct the problem. Contact your dealer if necessary.

## ROPS/FOPS

---

The ROPS/FOPS (Roll Over/Falling Object Protective Structure) is designed to provide protection for the operator from falling objects and in case the loader tips or rolls over, provided the operator is secured inside the ROPS by the seatbelt and restraint bar.

**⚠ WARNING** Never operate the loader with the ROPS/FOPS removed or locked back.

## Parking Brake

---

This skid-steer loader is equipped with a spring-applied hydraulic-released parking brake. The parking brake engages when the operator lifts the restraint bar, leaves the operator's seat or shuts off the engine. The brake can also be applied manually by using the switch located on the right control panel of the ROPS. The red indicator on the switch lights when the parking brake is applied.

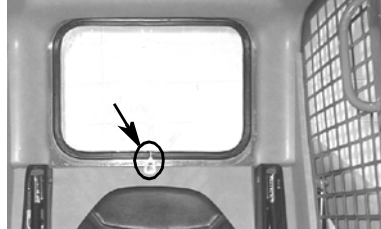

**Figure 2 Parking Brake Switch**

## Rear Window Emergency Exit

The ROPS rear window has three functions: noise reduction, flying objects barrier and emergency exit.

To use the emergency exit, pull on the yellow warning tag at the bottom of the window and remove the seal. Push out the window and exit.



**Figure 3 Rear Window  
Emergency Exit**

1. Pull Tag

## Lift Arm Support Device

The lift arm support device on the left lift cylinder is used as a cylinder lock to prevent the raised lift arm from unexpectedly lowering. Be sure to engage the support device when the lift arm is raised for service. When the support device is not being used, store it under the lift arm using the lock pin. The support device is a safety device that must be kept in proper operating condition at all times. The following steps ensure correct usage:

**⚠ WARNING** The safest method of engaging the lift arm support device requires two people – one person inside the loader and another person to engage the support device.

*Note: With the keyswitch OFF and the solenoid valve working, the lift arm will stay raised when the lift control is moved to lower the lift arm. If the valve does not hold the lift arm and it begins to lower, do not leave the operator's compartment. Instead, have someone store the support device for you. Then, contact your Mustang dealer immediately to determine why the lift arm lowers while the keyswitch is OFF.*



## Engagement

**⚠ WARNING** Always engage the lift arm support device before leaving the operator's compartment to work on the loader with the lift arm raised.

To engage the lift arm support device:

1. Lower the lift arm fully onto the loader frame.
2. Stop the engine.
3. Leave the operator's compartment. Remove the lock pin holding the support device up against the lift arm. Allow the support device to drop down into contact with the lift cylinder.
4. Return to the operator's compartment and start the engine.
5. Raise the lift arm until the lift arm support device drops over the end of the lift cylinder and around the cylinder rod. Slowly lower the lift arm until the support device contacts the top end of the lift cylinder.
6. Be sure the support device is secure against the cylinder end. Then, stop the engine, remove the key and leave the operator's compartment.



**Figure 4 Lift Arm Support Device Engaged**

## Disengagement

**⚠ WARNING** Never leave the operator's compartment to disengage the lift arm support device with the engine running.

To return the lift arm support device to its storage position:

1. Raise the lift arm completely.
2. Stop the engine, remove the key and take it with you.



Figure 5 Lock Pin in storage Position

**⚠ WARNING** Before testing the loader, always clear people from the area.

3. Before leaving the operator's compartment, be sure that the lift arm is being held in the raised position by the solenoid valve.
4. To store the support device, raise it up until it contacts the lift arm. Slide the lock pin through the support device and catch under the lift arm. Once the pin is secure, flip the lock pin loop so that it locks the pin in.

## Accessory Outlet

---

The optional 12-volt accessory outlet is located at the bottom of the left instrument panel.

## Engine Speed Control

---

A right-hand controlled throttle lever is provided on all models for adjusting the engine speed. Move the control forward to increase the engine speed and rearward to decrease the engine speed.

**T-Bar Controls Only:** A right-foot operated accelerator pedal is provided to control the engine speed. The pedal linkage is spring-loaded to return to the adjusted hand-operated throttle setting.

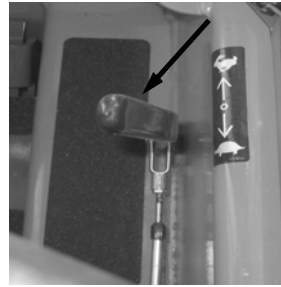

Figure 6 Throttle Lever

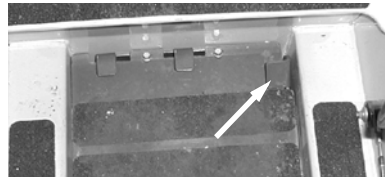

Figure 7 Foot Pedal (T-Bar)

## Instrument Panel

The instrument panel contains the following switches and indicators. Symbols on the panel represent various functions and conditions, and are visible only when indicator lamps are on.

1. **Hourmeter** – Displays the total operating hours on the loader.
2. **Fuel Level Gauge** – Displays the amount of fuel in the tank.
3. **Engine Coolant Temperature Gauge** – Indicates the engine coolant temperature.

*Note: Items 4 through 9 are indicator lamps which display the following:*

4. **Fasten Seatbelt** – A momentary visual (and audible) indicator to remind the operator to fasten the seatbelt.
5. **Engine Oil Pressure** – Lights if the engine oil pressure drops too low, warning the operator to immediately stop the engine and determine the cause for the pressure drop. During normal operation, this indicator should be OFF.
6. **Battery** – Lights if the charging voltage is too high or too low. During normal operation, this indicator should be OFF.
7. **Preheat Indicator Lamp** – Lights when the preheat switch is pressed. During normal operation, this indicator should be OFF.
8. **Engine Coolant Temperature** – Lights if the engine coolant becomes too hot, warning the operator to stop the engine. Allow the engine to cool, determine the cause for the high temperature and correct the problem before restarting the engine. During normal operation, this indicator should be OFF.
9. **Hydraulic Oil Temperature** – Lights if the hydraulic oil becomes too hot, warning the operator to stop engine. Allow the hydraulic system to cool and determine the cause of the high temperature. During normal operation, this indicator should be OFF.

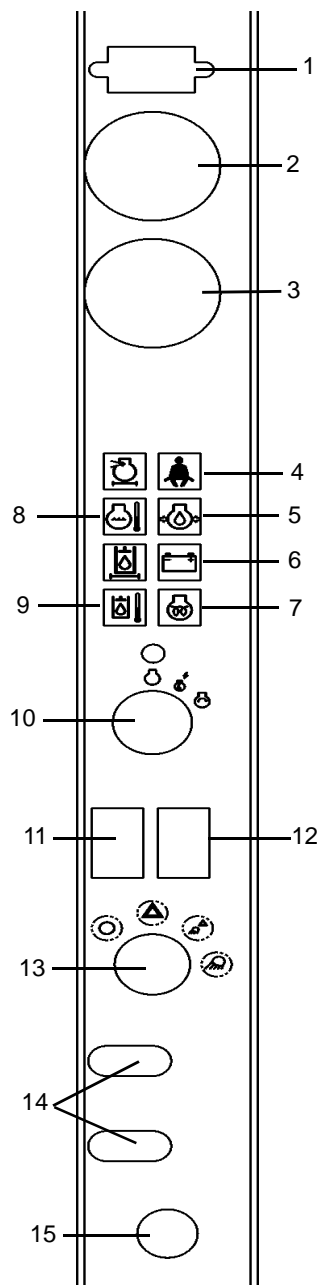

Figure 8 Instrument Panel

**10. Keyswitch** – In a clockwise rotation, these positions are:

**OFF Position** – With the key vertical, power from the battery is disconnected to the controls and instrument panel electrical circuits. This is the only position the key can be inserted or removed from the keyswitch.

**ON (or Run) Position** – With the key turned one position clockwise from vertical, power from the battery is supplied to all control and instrument panel electrical circuits.

**START Position** – With the key turned fully clockwise, the electric starter energizes, start the engine. Release the key to the RUN position after the engine starts.

*Note: The engine cannot be started unless the operator is sitting in the seat and the restraint bar is lowered.*

**11. Parking Brake Switch** – Used to manually apply the parking brake. The red indicator on the switch lights when the parking brake is applied.

**12. Preheat Switch** – Used to preheat the engine for starting in cold conditions.

**13. Light Switch** – Controls all the lights on the loader. Symbols denote the four positions of the light switch. In a clockwise direction these are:

- OFF
- Hazards
- Front work lights, red tail lights and hazards
- Front work lights, red tail lights and rear work lights

For the lights to function, the keyswitch must be in the RUN position.

**14. Circuit Breakers** – Four circuit breakers on the instrument panel protect the loader's electrical circuits.

*Important: Do not attempt to defeat the circuit protection by jumping across a circuit breaker or by using a higher amperage circuit breaker.*

**15. Accessory Outlet** – 12-volt DC power outlet.

## T-Bar Controls

The Mustang loader may be equipped with the T-Bar control option. The left T-Bar controls the drive and the right T-Bar controls the lift/tilt.

### Drive Controls

Forward, reverse, speed and turning maneuvers are controlled by movement of the left T-Bar. To go **forward**, push the control forward; for **reverse**, pull the control rearward. To turn **right**, twist the control clockwise; to turn **left**, twist the control counterclockwise. For gradual turns, twist the T-Bar slightly clockwise or counterclockwise. For sharp turns, twist the control fully clockwise or counterclockwise.

Moving the T-Bar farther from neutral increases the speed steadily to the maximum travel speed. Tractive effort decreases as speed increases. For maximum tractive effort, move the T-Bar only slightly from the neutral position. The engine will stall if the control is moved too far forward when loading the bucket.

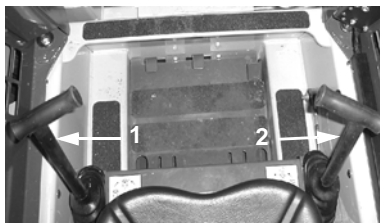

**Figure 9 T-Bar Controls**

1. Drive Control
2. Lift/Tilt Control

**WARNING** Be sure the controls are in neutral before starting the engine. Operate the controls gradually and smoothly. Excessive speed and quick control movements without regard for conditions and circumstances are hazardous and could cause an accident.

### Lift/Tilt Control

Moving the lift arm and tilting the attachment are accomplished by movement of the right T-Bar. To **raise** the lift arm, pull the control straight rearward; to **lower** the lift arm, push the control straight forward. To **tilt the attachment downward**, twist the control clockwise; to **tilt the attachment up** or back, twist the control counterclockwise.

*Note: The speed of the lift/tilt motion is directly proportional to the amount of T-Bar movement and engine speed.*

To place the lift arm into the detent (“float”) position, push the right T-Bar all the way forward into the detent. This position allows the lowered lift arm to “float” while traveling over changing ground conditions.

**WARNING** Never push the lift/tilt T-Bar control into the float position with the attachment loaded or raised, because this will cause the lift arm to lower rapidly.

## Hand/Foot Controls

The Mustang loader may be equipped with the hand/foot control option. The handles control the drive and the foot pedals control the lift/tilt.

### Drive Controls

Forward, reverse, speed and turning maneuvers are controlled by movement of the control handles. To go **forward**, push both handles forward; for **reverse**, pull both handles rearward. For **turning**, move one handle farther forward or rearward than the other handle. Turn direction is determined by which handle is moved the farthest forward; to turn left, move the right handle farther forward than the left handle. For sharp turns, move the handles in opposite directions.

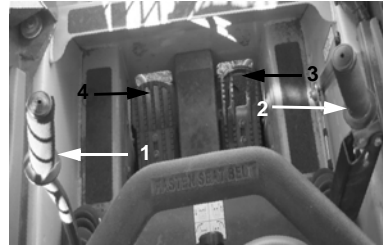

**Figure 10 Hand/Foot Controls**

1. Left Drive Control Handle
2. Right Drive Control Handle
3. Tilt Control Foot Pedal
4. Lift Control Foot Pedal

Moving the handles farther from neutral increases the speed steadily to the maximum travel speed. Tractive effort decreases as speed increases. For maximum tractive effort, move the handles only slightly from the neutral position. The engine will stall if the controls are moved too far forward when loading the bucket.

**⚠ WARNING** Be sure the controls are in neutral before starting the engine. Operate the controls gradually and smoothly. Excessive speed and quick control movements without regard for conditions and circumstances are hazardous and could cause an accident.

### Lift/Tilt Controls

Moving the lift arm and tilting the attachment are accomplished by movement of the foot pedals. The left pedal raises and lowers the lift arm; the right pedal tilts the attachment. To **raise** the lift arm, use your heel to push down on the left pedal; to **lower** the lift arm, use your toes to push down on the left pedal. To **tilt the attachment downward**, use your toes to push down on the right pedal; to **tilt the attachment up** or back, use your heel to push down on the right pedal.

*Note: The speed of the lift/tilt motion is directly proportional to the amount of pedal movement and engine speed.*

To place the lift arm in the detent (“float”) position, use your toes to push the left pedal all the way down into the detent. This position allows the lowered lift arm to “float” while traveling over changing ground conditions.

**⚠ WARNING** Never push the left pedal into the float position with the attachment loaded or raised, because this will cause the lift arm to lower rapidly.

## Auxiliary Hydraulic Controls

---

Auxiliary hydraulics are used with an attachment that has a mechanism requiring hydraulic power of its own.

**Important:** Always be sure the auxiliary hydraulic control is in neutral before starting the loader or removing the auxiliary hydraulic couplers.

Couplers are located on the left lift arm. “A” port is pressure, “B” port is return when the auxiliary control is in the detent position (refer to page 34).

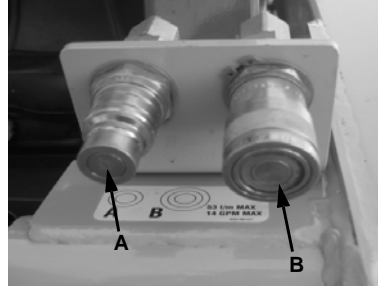

Figure 11 Auxiliary Couplers

### T-Bar Controlled Loaders

A foot pedal is used to control the direction of oil flow.

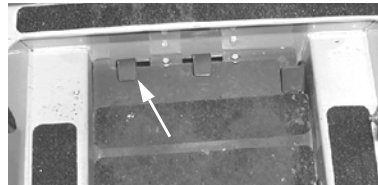

Figure 12 T-Bar Auxiliary Control



## Hand/Foot Controlled Loaders

The right handle controls the direction of oil flow. A locking pin locks it in the up position for continuous operation.



**Figure 13 Hand/Foot Auxiliary Control**

## Attachment Mounting

The Mustang loader is equipped with a two-pin All-Tach™ attachment bracket for mounting a bucket or other attachment. Two latch levers secure the attachment. Rotate the levers until they are horizontal to engage the latch pins. Rotate the levers until they are vertical to disengage the latch pins.



**Figure 14 All-Tach™ Attaching Mechanism (Hitch)**

**⚠ WARNING** To prevent unexpected attachment release from the hitch, be sure to secure the lock pins by rotating the levers downward into a horizontal position.

## Notes

---

# CHAPTER 4

## OPERATION

 **WARNING** Before starting the engine and operating the loader, review and comply with all safety recommendations in the *Safety* chapter of this manual. Know how to stop the loader before starting it. Also, be sure to fasten and properly adjust the seatbelt and lower the operator restraint bar.

### Before Starting the Engine

---

Before starting the engine and running the loader, refer to the *Controls and Safety Equipment* chapter and familiarize yourself with the various operating controls, indicators and safety devices on the loader.

### Starting the Engine

---

The following procedure is recommended for starting the engine:

1. Carefully step up onto the back of the bucket or attachment and grasp the ROPS handholds to get into the operator's compartment.
2. Fasten the seatbelt and lower the restraint bar.
3. Verify the following:
  - the lift/tilt, drive and auxiliary controls are in their neutral positions,
  - the brake is on.
4. Push the throttle forward to half speed.

*Note:* When the key is turned to the *RUN* position, an indicator will light on the instrument panel and a buzzer will sound momentarily to remind you to check that your seatbelt is fastened.

5. Turn the keyswitch to the *START* position.

**Important:** Do not engage the starter for longer than 15 seconds at a time. Longer use can overheat and damage the starter. Allow the starter to cool for 20 seconds between uses.

After the engine starts, allow a sufficient warm-up time before attempting to operate the controls.

**Important:** If the warning lights do not go off, stop the engine and investigate the cause.

### Cold Starting Procedure

---

 **WARNING** Do not use starting fluid (ether) with preheat systems. An explosion can result which can cause engine damage, injury or death.

Push the PREHEAT button on the instrument panel for a maximum of 30 seconds to preheat the engine. If the temperature is below 32°F (0°C), try the following to make starting the engine easier:

- Replace the engine oil with SAE 5W30.
- Make sure the battery is fully charged.
- Install a block heater on the engine.

Let the engine run for a minimum of five minutes to warm the engine and hydraulic fluid before operating the loader.

## Stopping the Loader

---

The following procedure is the recommended sequence for stopping the loader:

1. Check that the drive control handle(s) is (are) in “neutral” position.
2. Lower the lift arm and rest the attachment on the ground.
3. Pull the throttle lever back to the low idle position (and/or take your foot off the accelerator pedal for hands-only controlled machines).
4. Turn the keyswitch to the OFF position to shut off the engine.
5. Raise the restraint bar, unfasten the seatbelt and grasp the hand holds while climbing out of the operator’s compartment.

*Note: The skid-steer loader is equipped with a spring-applied automatic parking brake. The parking brake is engaged when the operator lifts the restraint bar, leaves the operator’s seat, shuts off the engine or when the brake switch is applied.*

## Parking the Loader

---

Park the loader on level ground away from traffic. If this is not possible, park the loader across the incline and block the tires to prevent movement.

## Jump Starting the Engine

---

If the battery becomes discharged or does not have enough power to start the engine, use jumper cables and the following procedure to jump-start the loader engine.

 **WARNING** The ONLY safe method for jump starting with a discharged battery is for TWO PEOPLE to perform the following procedure. The second person removes the jumper cables so that the operator does not have to leave the operator’s compartment with the engine running. NEVER make jumper cable connections directly to the starter solenoid of either engine. DO NOT start the engine from any position other than on the operator’s seat and then ONLY after being sure ALL controls are in “neutral”.

**Closely follow the procedure, in order, to avoid personal injury. In addition, wear safety glasses to protect your eyes and avoid leaning over the batteries while jump-starting.**

DO NOT jump-start the battery if it is frozen, because it may rupture or explode.

*Note: BE SURE the jumper battery is a 12-volt D.C. battery.*

1. Turn the keyswitches of both vehicles to OFF, be sure the vehicles are in “neutral” and NOT touching each other.
2. Connect the positive (+) jumper cable to the positive (+) battery terminal on the disabled loader first. DO NOT allow the positive clamps to touch any metal other than the positive (+) battery terminals.
3. Connect the other end of the positive jumper cable to the jumper vehicle’s battery positive (+) terminal.
4. Connect the negative (-) jumper cable to the jumper vehicle’s battery negative (-) terminal.
5. Make the final negative (-) jumper cable connection to the disabled loader’s engine block or loader frame (ground) – NOT to the disabled battery’s negative post. If connected to the engine, keep the jumper clamp away from the battery, fuel lines and moving parts.
6. Start the loader. If it does not start at once, start the jumper vehicle engine to avoid excessive drain on the booster battery.
7. After the disabled loader is started and running smoothly, have the second person remove the jumper cables (negative (-) jumper cable first) from the jumper vehicle’s battery and then from the disabled loader while being sure NOT to short the two cables together.

Allow sufficient time for the skid-steer loader alternator to build-up a charge in the battery before attempting to operate the loader or shut the engine off.

## Changing Attachments

**⚠ WARNING** To prevent unexpected attachment release from the attachment bracket, be sure to properly secure the latch pins by rotating the latch levers to a horizontal position.

The skid-steer loader features a All-Tach™ attaching mechanism for mounting a bucket or other attachment. Two latch levers secure the attachment.

### Connecting an Attachment

1. Rotate the latch levers to a vertical position to fully retract the latch pins.
2. Start the loader engine and make sure the lift arm is lowered and in contact with the loader frame.
3. Align the loader squarely with the back of the attachment.
4. Tilt the attachment bracket forward until the top edge of the bracket is below the flange on the back side of the attachment and centered between the vertical plates.

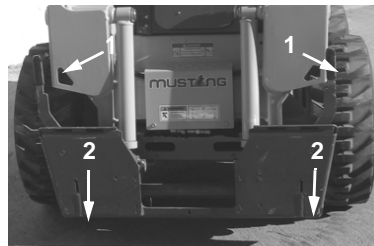

**Figure 15 Hitch – disengaged**

1. Latch Levers
2. Latch Pins

5. Slowly drive the loader forward and, at the same time, tilt the attachment bracket back to engage the flange on the back side of the attachment.
6. Stop forward travel when the flange is engaged, but continue to tilt the attachment bracket back to lift the attachment off the ground.
7. Exercise the MANDATORY SAFETY SHUTDOWN PROCEDURE (page 6).
8. With the loader engine OFF, leave the operator's compartment and rotate the latch levers to a horizontal position to fully engage the latch pins.

**Important:** To check that the attachment is properly installed, apply down pressure to the attachment prior to operating.

### Connecting Auxiliary Hydraulic Couplings

**Note:** With the engine OFF, key in the ON position and the restraint bar down, the auxiliary hydraulic control can be moved to relieve any pressure in the hydraulic system.

The hydraulic couplers are located on the left lift arm. “A” port is pressure, “B” port is return when the auxiliary control is in the detent position.

## Removing Attachments

1. Tilt the attachment bracket back until the attachment is off the ground.
2. Exercise the MANDATORY SAFETY SHUTDOWN PROCEDURE (page 6).
3. Relieve any hydraulic pressure in the auxiliary and attachment lines.
  - a. Turn the key switch, but do not start the engine.
  - b. With the restraint bar down, move the auxiliary hydraulic control back and forth. This will relieve the pressure in the hydraulic system.
4. With the engine OFF, leave the operator's compartment, disconnect the auxiliary hydraulic hoses and rotate the latch levers completely vertical to fully retract the latch pins.
5. Start the engine and be sure that the lift arm is fully lowered and in contact with the loader frame.
6. Tilt forward and slowly back the loader until the attachment is free from the loader.

## Self-Leveling (optional)

---

The feature is designed to keep the attachment level while the lift arm is being raised.

## Using a Bucket

---

 **WARNING** Always maintain a safe distance from electric power lines and avoid contact with any electrically charged conductor or gas line. Accidental contact or rupture can result in electrocution or an explosion. Contact the “Digger’s Hotline” or proper local authorities for utility line locations before starting to dig.

## Driving over Rough Terrain

When traveling over rough terrain, drive slowly with the bucket lowered.

## Driving on an Incline

When traveling up or down on an incline, travel with the heavy end pointing uphill. Try to avoid traveling on an incline, but always travel with the bucket as possible to maintain stability.

## Loading a Bucket

Approach the pile with the lift arm fully lowered and the bucket tilted slightly forward until the edge contacts the ground. Drive forward, lifting the lift arm and tilting back the bucket to fill it. Back away from the pile.

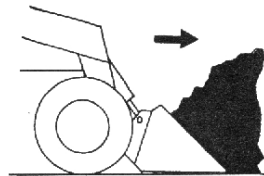

Figure 16 Loading

**⚠ WARNING** Always carry the loaded bucket with the lift arm resting on the loader frame. For additional stability when operating on inclines, always travel with the heavier end of the loader toward the top of the incline.

## Digging with a Bucket

Approach the digging site with the lift arm slightly raised and the bucket tilted forward until the edge contacts the ground. Break the ground by driving forward and gradually lowering the lift arm.

With the bucket filled, tilt the bucket back, and back the loader away from the material. Rest the lift arm against the loader frame before proceeding to the dumping area.

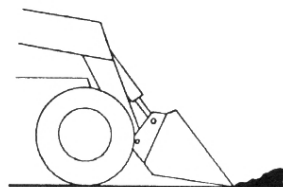

Figure 17 Digging

## Dumping the Load onto a Pile

Carry a loaded bucket as low as possible until reaching the pile. Gradually stop forward motion and raise the lift arm high enough so that the bucket clears the top of the pile. Then slowly move the loader ahead, to position the bucket to dump the material on top of the pile. Empty the bucket and back the loader away while tilting the bucket back and lowering the lift arm.

**⚠ WARNING** Never push the controls into the float position with the bucket or attachment loaded or raised, because this will cause the lift arm to lower rapidly.



## Dumping the Load Into a Box

Carry the loaded bucket low and approach the vehicle or bin. Stop your approach as close to the side of the box as possible while allowing for clearance to raise the lift arm and loaded bucket. Next, raise the lift arm until the bucket clears the top of the box and move the loader ahead, to position the bucket over the inside of the box, slowly dump the bucket. After the material is dumped, back away from the box while tilting the bucket back and lowering the lift arm.

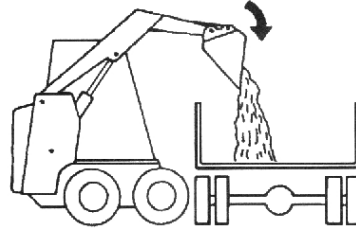

Figure 18 Dumping Into a Box

## Dumping the Load Over an Embankment

**⚠ WARNING** Do not drive too close to an excavation or ditch. Be sure the surrounding ground has adequate strength to support the weight of the loader and the load.

Carry the loaded bucket as low as possible while traveling to the dumping area. Stop the loader where the bucket extends half-way over the edge of the embankment. Tilt the bucket forward and raise the lift arm to dump the material. After the material is dumped, back away from the embankment while tilting the bucket back and lowering the lift arm.

## Scraping with a Bucket

For scraping, the loader should be operated in the forward direction. Position the lift arm down against the loader frame. Tilt the bucket cutting edge forward at a slight angle to the surface to be scraped. While traveling slowly forward with the bucket in this position, material can flow over the cutting edge and collect inside the bucket.

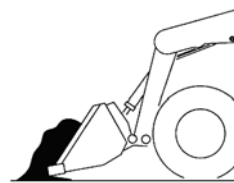

Figure 19 Scraping

## Leveling the Ground

Drive the loader to the far edge of the area to be leveled. Tilt the bucket forward to place the bucket cutting edge at a 30 to 45 degree angle to the surface to be leveled. Then place the lift arm into the “float” position and drive the loader rearward dragging the dirt and, at the same time, leveling it.

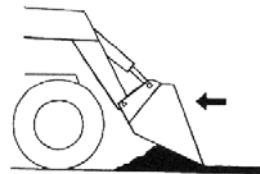



Figure 20 Leveling the Ground

*Note:* The float (detent) position for T-Bar controlled loaders is reached by pushing the right handle all the way forward. For hand/foot controlled loaders, use your toes to push the front of the left pedal all the way down.

 **WARNING** Check that the work area is clear of people and obstacles. Always look in the direction of travel.

## Highway Travel

---

If it becomes necessary to move the loader a long distance, obtain and use a properly rated trailer. For short distance highway travel, attach an SMV (Slow Moving Vehicle) emblem (purchased locally) to the back of the loader. For highway operation, obtain and install dual amber flashers or a strobe light. Check state and local laws and regulations.

## Lifting the Loader

---

The loader can be lifted using a single-point or four-point lift kit, which is available from your Mustang dealer.

 **WARNING**

- **Before lifting, check the lift kit for proper installation.**
- **Never allow riders in the operator's compartment while the loader is lifted.**
- **Keep everyone a safe distance away from the loader while it is lifted.**
- **Loader may only be lifted with an empty bucket or empty pallet forks, or with no attachment. Never lift the loader with attachments other than those stated.**

Lift equipment used and its installation is the responsibility of the party conducting the lift. All rigging **MUST** comply with applicable regulations and guidelines.

1. Using suitable lift equipment, hook into the lift eyes. Adjust the length of the slings or chains to lift the loader level.

**Important:** As needed, use a spreader bar to prevent the slings or chains from rubbing the sides of the ROPS/FOPS. (Four-point lift only)

**Note:** The loader may be slightly off level (10 degrees max.) when lifted, depending on loader model and attachment (single-point lift only.)

2. Center the hoist over the ROPS/FOPS. To prevent shock loading of the equipment and excessive swinging, slowly lift the loader off the ground. Perform all movements slowly and gradually. As needed, use a tag line to help position the loader.

## Storing the Loader

---

If your skid-steer loader is to be stored for a long period of time, the following procedure is suggested:

1. Fully inflate the tires.
2. Lubricate all grease zerks.
3. Check all fluid levels and replenish as necessary.
4. Add stabilizer to the fuel per the fuel supplier's recommendations.
5. Remove the battery, charge fully and store in a cool, dry location.
6. Protect against extreme weather conditions such as moisture, sunlight and temperature.

## Transporting the Loader

---

**⚠ WARNING** Park the truck or trailer on a level surface. Be sure the vehicle and its ramps have the weight capacity to support the loader. Make sure the vehicle surface and its ramps are clear of debris and slippery material that may reduce traction. Move the loader on and off the vehicle ramp slowly and carefully. Failure to follow these instructions could result in an overturn accident.

Observe all local regulations governing the loading and transporting of equipment. Ensure that the hauling vehicle meets all safety requirements before loading the skid-steer loader.

1. Place blocks at the front and rear of the hauling vehicle's tires.
2. If the loader has an attachment, lift it slightly off the ground.
3. Back the loader slowly and carefully up the ramp onto the vehicle.
4. Lower the loader attachment to the vehicle deck, turn off the engine and remove the key.
5. Fasten the loader to the hauling vehicle at the points indicated by the tie-down decals.
6. Measure the clearance height of the loader and hauling vehicle. Post the clearance height in the cab of the vehicle.



**Figure 21 Front Tie Down/Retrieval point**

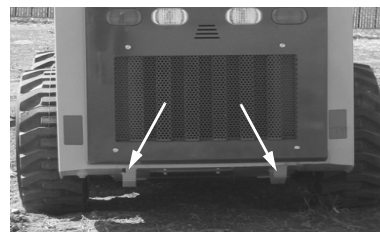

**Figure 22 Rear Tie Down/Retrieval point**

## Notes

---

# CHAPTER 5

## SERVICE

**WARNING** Before servicing the machine, unless expressly instructed to the contrary, exercise the **MANDATORY SAFETY SHUTDOWN PROCEDURE** (page 6).

After service has been performed, be sure to restore all guards, shields and covers to their original positions before resuming loader operation.

This *Service* chapter details procedures for performing routine maintenance checks, adjustments and replacements. Most procedures are referred to in the *Troubleshooting* and *Maintenance Schedule* chapters of this manual. Refer to the separate engine manual provided for engine-related adjustments, lubrication and servicing procedures.

*Note:* All service procedures, except those described under the “Dealer Services” topic are owner-operator responsibilities.

*Important:* More frequent service than the recommended intervals may be required under severe operating conditions. You must decide if your operation requires more service.

*Important:* Always dispose of waste lubricating oils and hydraulic fluids according to local regulations or take to a recycling center for disposal. Do not pour onto the ground or down the drain.

### Dealer Services

The following areas of component service, replacement and adjustments require special tools and knowledge for proper servicing and should be performed only by your authorized Mustang skid-steer loader dealer: hydrostatic components, hydraulic system gear pump, valves, cylinders, electrical components (other than the battery, circuit breakers).

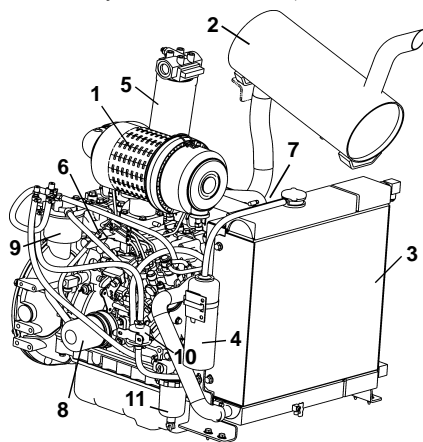

**Figure 23 Engine Compartment**

1. Air Cleaner
2. Muffler
3. Radiator/Cooler
4. Coolant Recovery Tank
5. Hydraulic Oil Filter
6. Engine Oil Dipstick
7. Engine Oil Fill Cap
8. Engine Oil Filter
9. Fuel Filter
10. Fuel Pump
11. Water Trap

## Tilting Back the ROPS/FOPS

---

For service, unbolt the two anchor bolts at the front of the ROPS/FOPS and tilt it back slowly, moving the control handles out of the way. A gas-charged spring helps tilt it back. A self-actuating lock mechanism engages to lock the ROPS/FOPS in a rolled-back position. To lower the ROPS/FOPS, apply upward force on it while pulling the lock mechanism handle toward the front of the loader. Lower the ROPS slowly onto the chassis, moving the control handles out of the way. Reinstall the anchor bolts, washers and locknuts.



Figure 24 ROPS Lock Mechanism

**⚠ WARNING** Never operate the loader with the ROPS/FOPS removed or locked back. Be sure the lock is securely engaged when the ROPS/FOPS is tilted back. Properly support the ROPS/FOPS when unlatching the lock mechanism and lowering the ROPS/FOPS. Be sure to reinstall the anchor bolts, washers and locknuts before resuming loader operation.

## Loader Raising Procedure

---

To raise the skid-steer loader so all four tires are off the ground, use the procedure below:

**⚠ WARNING** Do not rely on a jack or hoist to maintain the “raised” position without additional blocking and supports. Serious personal injury could result from improperly raising or blocking the skid-steer loader.

1. Using a jack or hoist capable of lifting the fully-equipped weight of the loader (with all attached options), lift the rear of the loader until the rear tires are off the ground.
2. Stack wooden blocks under the flat part of the loader chassis. They should run parallel with, but not touch, the rear tires (Figure 25).
3. Slowly lower the loader until its weight rests on the blocks. If the tires still touch the ground, raise the loader again, add more blocks and lower again.
4. Repeat Steps 1 through 3 for the front end. When the procedure is finished, all four tires will be off the ground so they can be removed.

## Loader Lowering Procedure

---

When service or adjustment procedures are complete, the skid-steer loader can be taken down from the “raised” position. To lower the loader onto its tires:

1. Using a jack or hoist, raise the front of the loader until its weight no longer rests on the front blocks.
2. Carefully remove the blocking under the front of the loader.
3. Slowly lower the loader until the front tires are resting on the ground.
4. Repeat Steps 1 through 3 for the rear of the loader. When the procedure is finished, all four tires will be on the ground and the blocks removed from under the loader.



**Figure 25 Blocked Loader**

## Replacement Parts

Part Description	Mustang Part No.
Air Cleaner Element, Primary	188814
Air Cleaner Element, Secondary	188817
Hydraulic Oil Filter Element	074830
Engine Oil Filter Element	182131
Fuel Filter Cartridge	182130

*Note: Part numbers may change. Your Mustang dealer will always have the latest part numbers.*

## Adjustments

### Control Handles

The control handles do not require routine adjustment. Refer to the *Service Manual* for the initial setup procedure.

### Fuel Sender

The fuel sender, located in the fuel tank, sends a signal to the fuel gauge indicating the amount of fuel left in the fuel tank.

Check the fuel sender periodically to ensure that the mounting screws are tight and that there is no fuel seepage around the gasket. If replacement is required, apply an RTV or gasket sealant around the gasket when restoring the fuel sender.

## Engine Speed Control

The throttle cable does not require routine adjustment. Refer to the *Service Manual* for the initial setup procedure.

Besides throttle cable adjustment, the throttle lever friction pad pressure can be readjusted if the throttle lever does not hold its position. Belleville washers and a lock nut on the throttle lever are used for making this adjustment.

## Drive Chains

The drive chains do not require routine adjustment. Refer to the *Service Manual* for the initial setup procedure.

## Lubrication

Listed below are the locations, temperature ranges and types of recommended lubricants to be used when servicing this machine. Refer to the separate engine manual for more information regarding recommended engine lubricants, quantities required and grades.

<b>Hydraulic System</b>	Use Mobil DTE 15M or equivalent that contains anti-rust, anti-foam and anti-oxidation additives, and conforms to ISO VG46. <b>Capacity:</b> 8 U.S. gallons (30 liters)
<b>Chaincases</b>	Use SAE15W-40 motor oil. <b>Capacity</b> (each side): 8 U.S. quarts (7.6 liters)
<b>Grease Fittings</b>	Use lithium based grease
<b>Engine</b>	Below 32°F (0°C) – Use SAE Grade* 10 or 10W-30 Above 32°F (0°C) – Use SAE Grade* 15W-40 *Service Classification: API - CH-4/CI-4 <b>Capacity:</b> 3-cylinder: 7.6 U.S. quarts (7.2 liters) 4-cylinder: 9.0 U.S. quarts (8.6 liters)

Refer to the following figure for grease fitting locations. Wipe dirt from the fittings before greasing them to prevent contamination. Replace any missing or damaged fittings. To minimize dirt build-up, avoid excessive greasing.





**Figure 26 Grease Every 10 Hours (or daily)**

1. Lift arm pivots (2)
2. Lift cylinder pivots (4)
3. Tilt cylinder pivots (2)
4. Attachment Bracket pivots (2)

## Engine Air Cleaner

**Important:** Failure to follow proper filter servicing instructions could result in catastrophic engine damage.

The air cleaner consists of an outer (primary) filter element and an inner (secondary) filter element. An air filter restriction indicator for monitoring the condition of the elements is located on the right side of the front of the air cleaner. If the air filter becomes restricted, this indicator will turn red to warn the operator that the element(s) require service. Push the reset button located on the end of the indicator after fitting a clean element. For

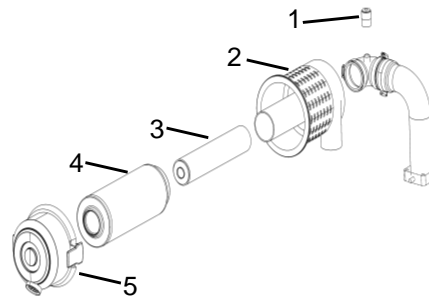

**Figure 27 Dual-Element Air Cleaner**

1. Restriction Indicator
2. Element Housing
3. Inner Filter Element
4. Outer Filter Element
5. Element Cover

replacement elements, refer to the “Replacement Parts” topic (page 43).

**Note:** *Before replacing the filter element(s), push the reset button on the indicator. Start the engine and adjust the throttle to full speed. If the indicator does not turn red, do **not** replace the element(s).*

The outer element should be replaced only when the restriction indicator turns red. The inner element should be replaced every third time the outer element is replaced, unless the outer element is damaged or the inner element is dirty.

Along with a daily check of the restriction indicator, check the air cleaner intake hose and clamps, and the mounting bracket hardware to be sure they are properly tightened.

### **Access**

1. Open the rear door and engine access cover.
2. Unlatch the clamps on the air cleaner and remove the cover. Clean out any dirt built up in the cover assembly.

### **Outer Element**

1. Carefully pull the outer element out of the housing. Never remove the inner element unless it is to be replaced.
2. Clean out any dirt built up in the housing. Leave the inner element installed during this step to prevent debris from entering the engine intake manifold.
3. Replace the outer element.

**Note:** *Mustang does not recommend cleaning the outer element.*

4. Use a trouble light inside the outer element to inspect for spots, pinholes or ruptures. Replace the outer element if any damage is noted. The outer element must be replaced if it is oil- or soot-laden.

### **Inner Element**

**Note:** *Replace the inner element only if it is dirty or if the outer element has been replaced three times.*

1. Before removing the inner element from the housing, clean out any dirt built up in the housing. Leave the inner element installed during this step to prevent debris from entering the engine intake manifold.
2. Remove the inner element.

## Reinstallation

1. Check the inside of the housing for any damage that may interfere with the elements.
2. Be sure that the element sealing surfaces are clean.
3. Insert the element(s), making sure that they are seated properly.
4. Secure the cover to the housing with clamps.
5. Check the hose connections and be sure they are all clamped and tightened properly.
6. Reset the restriction indicator by pressing the reset button.

## Engine Service

---

### Check Engine Mounting Hardware

All bolts that secure the engine mounting brackets to the engine and the loader frame should be checked and re-tightened as necessary.

**⚠ WARNING** Allow hot engine and hydraulic system components to cool before servicing.

### Checking Engine Oil Level

*Important:* For new units, the initial oil change should be after the first 50 hours.

Open the rear door and engine access cover. Pull out the dipstick and check the oil level. Markings on the dipstick represent FULL and LOW (add oil) levels.

Refer to the *Maintenance Interval Chart* (page 67) for the service interval for replacing the engine oil and filter.

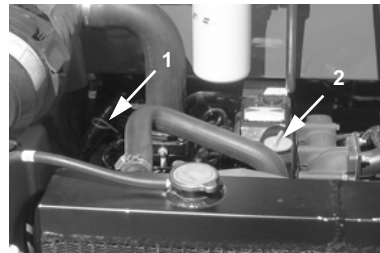

**Figure 28 Oil Dipstick and Fill Cap**

1. Oil Dipstick
2. Oil Fill Cap

## Changing Engine Oil and Filter

1. Run the engine until it is at operating temperature. Stop the engine. Remove the rear belly pan.
2. Remove the drain plug.
3. From the engine compartment, remove the oil filter. Clean the filter sealing surface.
4. Put clean oil on the new oil filter gasket. Install the filter and tighten 3/4 of a turn past the point where the gasket contacts the filter head.
5. Reinstall and tighten the drain plug.
6. Remove the oil cap and add the recommended oil. Refer to the “Lubrication” topic in this chapter for oil specifications and capacities.
7. Start the engine and let it run for several minutes at low idle. Stop the engine. Check for leaks at the oil filter, drain plug and remote oil drain hose. Check the oil level. Add oil if it is not at the top mark on the dipstick.



**Figure 29 Rear Belly Pan**

For a replacement element, refer to the “Replacement Parts” topic (page 43).

## Changing Fuel Filter

The engine has a fuel filter located on the left side of the engine. To change it:

1. Shut off the fuel supply by turning the fuel shutoff valve on top of the water trap.
2. Shut off return line by turning valve on the fuel tank.
3. Remove the fuel filter element.
4. Lubricate new fuel filter element gasket with diesel fuel.
5. Install and tighten the filter element one-half turn past point the where the gasket contacts the filter head.
6. Turn shutoff valve on water separator to ON.
7. Turn on the fuel supply at fuel tank.

The engine is self-priming. To remove air before starting, turn the ignition key to the ON position for 30 seconds.

For a replacement element, refer to the “Replacement Parts” topic (page 43).

## Servicing Water Separator

Periodically check for water in water separator by checking level of float in water separator bowl. If water is present:

1. Shut off the fuel supply by turning the fuel shutoff valve on top of the water separator.
2. Turn nut to release the bowl from the valve head. Dispose remaining fuel and water.
3. Clean bowl and filter element with warm water until all foreign material is removed. Replace fuel filter if damaged. Refer to Parts Manual for part number.
4. Place element onto valve head. Lubricate o-ring on bowl with diesel fuel and place on valve head. Turn nut to tighten.
5. Turn on fuel supply.

## Releasing Water from Separator

1. Check red float located in the water separator bowl. If red float is raised, open valve on the bottom of the bowl to drain water.
2. Close valve quickly after float reaches the bottom of the bowl.

## Spark Arrestor Muffler

---

**Important:** *The loader is factory-equipped with a spark arrestor type muffler. Muffler maintenance is required to keep it in working condition. Refer to local laws and regulations for spark arrestor requirements.*

1. Stop the engine, open the rear door and engine cover.
2. Remove the plug from the bottom of the muffler.
3. Block the outlet of the muffler with a non-combustible material.
4. Start the engine and run it for 10-15 seconds.
5. Stop the engine and remove the blockage.
6. Put anti-seize coating on the plug.
7. Reinstall and tighten the plug.

## Alternator/Fan Belt

---

Refer to the separate engine manual for setting proper belt tension. If the belt is worn, cracked or otherwise deteriorated, replace the belt by following the procedure in the separate engine manual.

## Hydraulic System

---

### Checking Hydraulic Oil Level

The loader has a dipstick located in the engine compartment. Check the fluid level with the lift arm lowered and the attachment on the ground.

When hydraulic fluid is required, allow the system to cool. Slowly remove the oil fill cap, allowing the pressure to dispel before removing the cap completely.

Add hydraulic fluid as required. Refer to the *Lubrication* topic (page 44) for oil recommendations. Replace the cap.

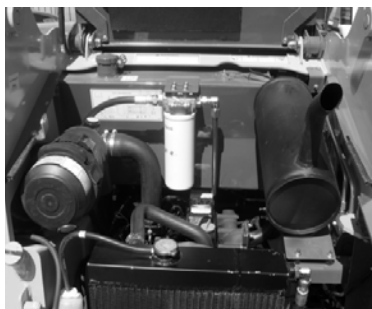

Figure 30 Hydraulic Oil Service

### Changing Hydraulic Oil Filter



#### WARNING

Before servicing the hydraulic filter, be sure the lift arm is lowered.

1. Open the rear door and engine cover to access the filter. Unscrew the filter.
2. Clean the surface of the filter housing where the element seal contacts the housing. Put clean oil on the rubber gasket of the new filter element.
3. Install and tighten the filter element 3/4 of a turn past the point where the gasket contacts the filter head.
4. For a replacement element, refer to the *Replacement Parts* topic (page 43).



Figure 31 Drain Plug

### Changing Hydraulic Oil

The hydraulic oil must be replaced if it becomes contaminated, after major repairs, and after 1000 hours or one year of use.

1. Remove the oil filler cap.
2. Install a catch pan of sufficient capacity under the oil reservoir (8 gallons [30 liters])
3. Remove the drain plug located on the bottom left of the oil reservoir.
4. Remove and replace the hydraulic oil filter.
5. Reinstall the drain plug.
6. Refill the reservoir until the oil is between the two lines on the dipstick gauge.
7. Start the engine and operate the hydraulic controls.

8. Stop the engine and check for leaks at the filter and reservoir drain plug.
9. Check the fluid level and add fluid if needed.

## Cooling Systems

---

**Important:** Check the cooling system every day to prevent overheating, loss of performance or engine damage.

### Checking Coolant Level

1. Open the rear door. Check the coolant level in the coolant recovery tank on the inside of the rear door. The coolant recovery tank must be 1/3 to 1/2 full with a cold engine and 2/3 to 3/4 full with a hot engine.
2. Allow the coolant to cool. Do not remove the cap when the coolant is hot. Serious burns may occur.
3. Add premixed coolant, 50% water and 50% ethylene glycol, to the recovery tank if the coolant level is low.



**Figure 32 Cooling System**

1. Recovery Tank
2. Radiator/Cooler
3. Drain Plug

### Cleaning Cooling System

1. Park the loader on a level surface, lower the lift arm and stop the engine. Allow the engine to cool.
2. Open the rear door. Lift the engine cover.
3. Clean the radiator and oil cooler by blowing through the fins with high pressure water or air.

**Note:** The radiator can be tipped out for cleaning by loosening and rotating the over-center links on each side. This will also help in cleaning the oil cooler.

### Draining/Flushing Cooling System

1. Open the rear door. Lift the engine cover.
2. Slowly remove the radiator cap, allowing pressure to dispel before removing completely.

**⚠ WARNING** Liquid cooling systems build up pressure as the engine becomes hot. Before removing the radiator cap, stop the engine and let the system cool. Remove the radiator cap only after the coolant has cooled. Remove the cap slowly or severe burns may result.

3. Remove the drain plug and drain the coolant into a suitable container.
4. Replace the drain plug.

**Note:** Protect the cooling system by adding premixed 50% water and 50% ethylene glycol to the system. This mixture will protect the cooling system to -34°F (-36°C).

5. Fill the radiator fully and the recovery tank half full with the premixed coolant.
6. Reinstall the radiator cap.
7. Run the engine until it is at operating temperature. Stop the engine and let it cool. Check the coolant level. Add more coolant if required.



**Figure 33 Check Plug**

## Chaincases

The chaincase contains the drive sprockets and drive chains. There are two plugs in each chaincase. One is to drain the fluid and the other is to check the fluid level. Refer to the *Maintenance Schedule* chapter (page 67) for change intervals. Refer to the *Lubrication* topic (page 44) for information on oil type and quantity.

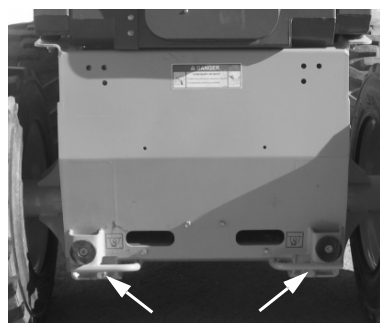

**Figure 34 Drain Plugs**

### Checking and Adding Oil

1. Park the loader on a level surface. Stop the engine.
2. Remove the check plug from each chaincase housing. If the oil can be reached with the tip of your finger, the oil level is adequate.
3. If the level is low, add fluid through the check plug until the oil level reaches the edge of the hole. Reinstall the check plug.

### Draining Oil

1. Raise the rear of the machine to aid in draining the chaincases.
2. Remove the drain plug on each chaincase and drain the oil into a suitable container.
3. Reinstall and tighten the drain plugs.
4. Refill the chaincases at the check plugs.

## Seat and Restraint Bar Switches

Electrical switches in the seat and restraint bar must be closed (operator sitting in the seat and restraint bar lowered) to complete the circuit and start the engine.



## Bucket Cutting Edge

---

The bucket cutting edge should be replaced when it is worn to within 1 in. (25 mm) of the bucket body.

## Wheel Nuts

---

Wheel nut torque must be checked before initial operation and every two hours thereafter until the wheel mounting hardware torque stabilizes at the recommended setting of 120-130 ft-lbs (161-175 N·m). When tires are removed and replaced, this procedure must be repeated.

## Tires

---

Rear tires usually wear faster than the front ones. To keep tire wear even, rotate the tires from front to rear and rear to front.

It is important to keep the same size tire on each side of the loader to prevent excessive wear on tires or other damage. If different sizes are used, each tire will be turning at different speeds, causing excessive wear.

The tread bar of all tires must face the same direction.

## Mounting Tires

 **WARNING** Inflating or servicing tires can be dangerous. When possible, trained personnel should service and mount tires. To avoid possible death or serious injury, follow the safety precautions below.

1. Be sure the rim is clean and free of rust.
2. Lubricate the tire beads and rim flanges with a soap solution. Do not use oil or grease.
3. Use a clip-on tire chuck with remote hose and gauge, allowing you to stand clear while inflating the tire. Do not place your fingers on the tire bead or rim during inflation.
4. Never inflate beyond 35 psi (240 kPa) to seat the beads. If the beads have not seated by the time the pressure reaches 35 psi (240 kPa), deflate the assembly, reposition the tire on the rim, lubricate both parts and re-inflate. Inflation pressure beyond 35 psi (240 kPa) with unseated beads may break the bead or rim with explosive force sufficient to cause death or serious injury.
5. After seating the beads, adjust the inflation pressure to the recommended operating pressure.
6. Do not weld, braze or otherwise attempt to repair and use a damaged rim.

## Checking Tire Pressure

Tire Size	Inflation Pressure	
	psi	kPa
10 x 16.5 8-ply Heavy-Duty Flotation	60	414
27 x 8.5 –15 8-ply Heavy-Duty	60	414
27 x 10.5 – 15 8-ply Heavy-Duty	60	414
6.5 x 16 – 5.50 Solid Rubber	-	-
7.00-15 SS Chevron Narrow 8-ply	60	414

Correct tire pressure should be maintained for all tires to enhance operating stability and extend tire life. Refer to the above chart for the proper inflation pressure.

When installing tires, be sure they are the same size and style on each side of the loader. Always replace tires with the same size as the original equipment.

## Electrical System

---

### Circuit Breakers

The circuit breakers for the loader are located on the right instrument panel. There is also a 35-amp main circuit breaker located on the right side of the engine compartment, directly behind the ROPS/FOPS.

## Battery

 **WARNING** Before servicing the battery or electrical system, be sure the battery disconnect switch (if equipped) is in the “OFF” position. If not equipped with a disconnect switch, disconnect the ground (-) terminal from battery.

The battery on the loader is a 12-volt, wet-cell battery. To access the battery, open the rear door and lift the engine cover.

The battery top must be kept clean. Clean it with an alkaline solution (ammonia or baking soda and water). After foaming has stopped, flush the battery top with clean water. If the terminals and cable connection clamps are corroded or have a build-up, disconnect the cables and clean the terminals and clamps with the same alkaline solution.

 **WARNING** Explosive gas is produced while a battery is in use or being charged. Keep flames or sparks away from the battery area. ALWAYS charge the battery in a well-ventilated area.

Never lay a metal object on top of a battery, because a short circuit can result.

Battery acid is harmful on contact with skin or fabrics. If acid spills, follow these first-aid tips:

1. Immediately remove any clothing on which acid spills.
2. If acid contacts the skin, rinse the affected area with running water for 10 to 15 minutes.
3. If acid contacts the eyes, flood the eyes with running water for 10 to 15 minutes. See a doctor at once. Never use any medication or eye drops unless prescribed by the doctor.
4. To neutralize acid spilled on the floor, use one of the following mixtures:
  - a. 1 pound (0.5 kg) of baking soda in 1 gallon (4 L) of water
  - b. 1 pint (0.5 L) of household ammonia in 1 gallon (4 L) of water

Whenever the battery is removed, be sure to disconnect the negative (-) battery terminal connection first.

## Notes

---

# CHAPTER 6

## TROUBLESHOOTING

### Electrical System

Problem	Possible Cause	Remedy
<b>Entire electrical system does not function.</b>	Battery disconnect switch is OFF. 15-ampere breakers tripped. Main wiring harness connectors at rear of ROPS not properly plugged in. Battery terminals or cables are loose or corroded. Battery is faulty.	Turn battery disconnect switch to ON. Check circuit and locate trouble before resetting breaker. Check main harness connectors. Clean battery terminals and cables and retighten them. Test battery and replace as needed.
<b>No instrument panel lamps with keyswitch turned to "ON."</b>	25 ampere breakers are tripped. Battery terminals or cables are loose or corroded.	Check circuit and locate trouble before resetting breaker. Clean battery terminals and cables and retighten them.
<b>Seatbelt buzzer not sounding when key turned to "ON," indicator lamps work properly.</b>	Buzzer is disconnected. Faulty buzzer.	Reconnect wires to buzzer. Replace buzzer.
<b>Fuel gauge does not work.</b>	Faulty fuel gauge sender. Faulty fuel gauge. Loose wiring/terminal connections.	Replace fuel gauge sender. Replace fuel gauge. Verify wiring connections.
<b>Engine temperature gauge does not work.</b>	Faulty temperature sender. Faulty temperature gauge. Loose wiring/terminal connections.	Replace temperature sender. Replace temperature gauge. Verify wiring connections.
<b>Hourmeter does not work.</b>	Loose wiring/terminal connections. Faulty alternator. Faulty hour meter.	Verify wiring connections. Repair the alternator. Replace hour meter.

## Electrical System

Problem	Possible Cause	Remedy
<b>Starter will not engage when key is turned to START.</b>	<p>Seat or restraint bar switch malfunctioning or not activated.</p> <p>Poor connections to starter relay in instrument panel.</p> <p>Battery terminals or cables loose or corroded.</p> <p>Faulty starter relay in instrument panel.</p> <p>Battery discharged or defective.</p> <p>Starter solenoid not functioning.</p> <p>Ignition wiring, seat switch, restraint bar switch, etc. loose or disconnected.</p> <p>Starter or pinion faulty.</p>	<p>Replace switches as needed. If engine still doesn't start, contact your dealer.</p> <p>Verify relay connections.</p> <p>Clean terminals, cables and retighten.</p> <p>Contact your dealer.</p> <p>Recharge or replace battery.</p> <p>Troubleshoot circuit. Replace the starter solenoid.</p> <p>Check wiring for poor connections, broken leads; repair wiring or connection.</p> <p>Remove starter; repair/replace as needed.</p>
<b>Work lights not functioning properly.</b>	<p>Single light doesn't work: Light bulb burned out, faulty wiring.</p> <p>No lights at all; 25-ampere breaker tripped.</p> <p>Faulty light switch or poor ground.</p>	<p>Check and replace light bulb as needed. Check wiring connection to light.</p> <p>Check circuit and locate trouble before replacing fuse.</p> <p>Replace light switch. Check ground wire connections.</p>
<b>Lift/Tilt and/or drive lock solenoids do not work.</b>	<p>Wiring to solenoids disconnected or faulty.</p> <p>Faulty seat or restraint bar switch.</p> <p>Faulty solenoid valve coil.</p> <p>Faulty hydraulic solenoid relay in instrument panel.</p>	<p>Troubleshoot circuit, repair.</p> <p>Contact your dealer.</p> <p>Contact your dealer.</p> <p>Contact your dealer.</p>

## Engine

Problem	Possible Cause	Remedy
<p><b>Engine turns over but will not start.</b></p>	<p>Engine cranking speed too slow.</p> <p>Auxiliary valve engaged.</p> <p>Fuel tank empty or faulty fuel gauge sender.</p> <p>Glow plug module malfunctioning.</p> <p>Fuel shut-off solenoid not energizing.</p> <p>Engine oil not warm enough.</p> <p>Ambient temperature is too low.</p> <p>Fuel pump not working.</p>	<p>Battery requires recharging or replacing, or, in cold temperatures, pre-warm the engine.</p> <p>Return control valves to neutral.</p> <p>Refill fuel tank. Replace fuel gauge sender.</p> <p>Check connection and voltage, replace as needed.</p> <p>Check electrical connections and voltage to shut-off solenoid.</p> <p>Install a pan heater.</p> <p>Install a pan heater.</p> <p>Contact your dealer.</p>
<p><b>Engine overheats.</b></p>	<p>Crankcase oil level too low or too high.</p> <p>Fan air circulation blocked or restricted.</p> <p>Fan shroud improperly positioned.</p> <p>Grade of oil improper or excessively dirty.</p> <p>Exhaust restricted.</p> <p>Air filter is restricted.</p>	<p>Add or remove oil as required.</p> <p>With engine OFF, remove blockage or restriction.</p> <p>Contact your dealer.</p> <p>Drain and replace with proper grade new oil.</p> <p>Allow exhaust to cool, remove restriction.</p> <p>Replace the filter(s).</p>

## Hydrostatic System

Problem	Possible Cause	Remedy
<b>No response from either hydrostatic drive or the lift/tilt systems.</b>	Hydraulic oil viscosity is too heavy.	Allow longer warm-up or replace existing oil with the proper viscosity oil.
	Hydraulic oil supply is too low.	Check for low oil level in reservoir. Add oil.
	Drive coupling failure.	Replace the coupling.
<b>Traction drive will not operate in either direction.</b>	Parking brake is engaged.	Disengage parking brake.
	Hydraulic oil supply is low.	Check for low oil level in reservoir. Add oil.
	Control rod linkage disconnected.	Check linkage connection at control levers and neutral centering mechanisms. Reconnect linkage.
	Low or no charge pressure.	Contact your dealer.
	Hydrostatic pump(s) relief valves are malfunctioning.	Contact your dealer.
<b>Sluggish response to acceleration.</b>	Air in hydraulic system.	Cycle lift and tilt cylinders to maximum stroke and maintain pressure for a short time to clear air from system. Also check for low oil level in reservoir, fill as needed.
	Automatic parking brake partially engaged.	Contact your dealer.
	Hydraulic oil supply is too low.	Check for low oil level in reservoir. Add oil.
	Low hydrostatic system charge pressure.	Contact your dealer.
	Drive motor(s) or hydrostatic pump(s) have internal damage or leakage.	Contact your dealer.



## Hydrostatic System

Problem	Possible Cause	Remedy
<p><b>Hydrostatic drive is overheating.</b></p>	<p>Drive system overloaded continuously.</p> <p>Lift/tilt or auxiliary system overloaded continuously.</p> <p>Drive motor(s) or hydrostatic pump(s) have internal damage or leakage.</p> <p>Oil cooler fins plugged with debris.</p> <p>Loader being operated in a high temperature area with no air circulation.</p>	<p>Improve efficiency of operation.</p> <p>Improve efficiency of operation.</p> <p>Contact your dealer.</p> <p>Clean oil cooler fins.</p> <p>Reduce duty cycle; improve air circulation.</p>

## Hydrostatic System

Problem	Possible Cause	Remedy
<b>Hydrostatic (drive) system is noisy.</b>	Hydraulic oil viscosity is too heavy.  Air in hydraulic system.  Drive motor(s) or hydrostatic pump(s) have internal damage or leakage.	Allow longer warm-up or replace existing oil with the proper viscosity oil.  Cycle lift and tilt cylinders to maximum stroke and maintain pressure for a short time to clear air from system. Also check for low oil level in reservoir, fill as needed.  Contact your dealer.
<b>Right side doesn't drive in either direction. Left side operates normally.</b>	Rear hydrostatic pump arm control shaft key missing.  Relief valves on rear hydrostatic pump malfunctioning.  Control rod linkage to rear hydrostatic pump disconnected.	Contact your dealer.  Contact your dealer.  Attach control rod linkage.
<b>Right side doesn't drive in forward direction.</b>	Relief valve on rear hydrostatic pump is malfunctioning.  Rear hydrostatic pump malfunctioning.	Contact your dealer.  Contact your dealer.
<b>Left side doesn't drive in either direction. Right side operates normally.</b>	Key missing on front hydrostatic pump arm control shaft.  Relief valves on front hydrostatic pump malfunctioning.  Control rod linkage to front hydrostatic pump disconnected.	Contact your dealer.  Contact your dealer.  Attach control rod linkage.
<b>Left side doesn't drive in one direction.</b>	Relief valve on front hydrostatic pump is malfunctioning.  Front hydrostatic pump malfunctioning.	Contact your dealer.  Contact your dealer.

## Hydraulic System

Problem	Possible Cause	Remedy
<b>Lift/Tilt controls fail to respond.</b>	<p>Hydraulic oil viscosity is too heavy.</p> <p>Hydraulic oil level is low.</p> <p>Solenoid valve(s) malfunctioning.</p> <p>Restraint bar or seat switch malfunction.</p>	<p>Allow longer warm-up or replace with proper viscosity oil.</p> <p>Check oil level in reservoir. If oil is low, check for an external leak. Repair and add oil.</p> <p>Check electrical connections to lift solenoid and repair.</p> <p>Check switches.</p>
<b>Auxiliary hydraulics do not function.</b>	<p>Restraint bar is raised.</p> <p>Lock solenoid malfunctioning</p> <p>Restraint bar switch malfunctioning.</p>	<p>Lower the restraint bar.</p> <p>Check electrical connections to lock solenoid and repair connections as needed. If lock solenoid is still not functioning properly, contact your dealer.</p> <p>Check electrical connections to restraint bar switch and repair connections as needed. If switch is still not functioning properly, contact your dealer.</p>
<b>Hydraulic cylinder action is slow for lift and/or tilt functions.</b>	<p>Low engine speed.</p> <p>Hydraulic oil viscosity is too heavy.</p> <p>Control linkage is restricted.</p> <p>Hydraulic oil leaking past cylinder piston seals.</p> <p>Worn gear pump.</p> <p>Solenoid valve(s) could be malfunctioning.</p> <p>Relief valve in control valve not functioning correctly. (Squealing noise should be evident while operating.)</p>	<p>Operate engine at higher speed.</p> <p>Allow longer warm-up or replace existing oil with proper viscosity oil.</p> <p>Check for control linkage restriction and adjust.</p> <p>Contact your dealer.</p> <p>Contact your dealer.</p> <p>Check electrical connections to lift solenoid and repair connections as needed. If lift solenoid valve is still not functioning properly, contact your dealer.</p> <p>Contact your dealer.</p>

## Hydraulic System

Problem	Possible Cause	Remedy
<b>Bucket does not level on the lift cycle.</b>	Self-leveling valve misadjusted or malfunctioning.	Contact your dealer.
<b>Jerky lift arm and bucket action.</b>	Seat or restraint bar switch malfunction.  Air in the hydraulic system.  Oil in hydraulic reservoir is low.	Check electrical connections to the switches. Replace as needed.  Cycle lift/tilt cylinders to maximum stroke and maintain pressure for short time to clear air from system.  Check and add oil.
<b>Bucket drifts downward with tilt control in neutral.</b>	Oil leaking past tilt cylinder seals (internal or external).  Self-leveling valve is malfunctioning.  Leaking hydraulic hoses, tubes, or fittings between control valve and cylinders.	Contact your dealer.  Contact your dealer.  Inspect hoses and tubes, tighten fittings. Replace hoses or tubes as needed.
<b>No down pressure on the bucket.</b>	Control valve in float position.  Tilt cylinders are malfunctioning.  Relief valve in control valve not functioning properly. (Squealing noise should be evident while operating.)	Take control out of float position.  Contact your dealer.  Contact your dealer.
<b>Bucket will not tilt, lift arms work properly.</b>	Tilt solenoid valve malfunctioning.    Tilt spool in control valve not actuated or leaking.	Check electrical connections to tilt solenoid and repair connections as needed. If tilt solenoid valves are still not functioning properly, contact your dealer.    Check valve control linkage and/or tube connections to valve.
<b>Slow or no response for bucket tilt, lift works properly (Hand/Foot units only).</b>	Pilot control lines have air in them.  Low charge pressure.  Linkage misadjusted between right foot pedal and pilot valve.	Bleed the pilot control line from the main control valve.  Contact your dealer.  Readjust for full travel without restriction.

## Hydraulic System

Problem	Possible Cause	Remedy
<b>Lift arm does not raise, bucket tilt works properly.</b>	Lift solenoid valve could be malfunctioning.  Lift spool in control valve not actuated or leaking.	Check electrical connections to lift solenoid and repair connections as needed. If lift solenoid valve is still not functioning properly, contact your dealer.  Contact your dealer.
<b>Lift arm doesn't maintain raised position with lift control in NEUTRAL.</b>	Oil leading past lift cylinder seals (internal or external). Oil leaking past lift spool in control valve. Self-leveling valve malfunctioning. Leaking hydraulic hoses, tubes or fittings between control valve and cylinders.	Contact your dealer.  Contact your dealer.  Contact your dealer.  Inspect hoses and tubes, tighten fittings as needed. Replace as needed.
<b>Lift arm will not lower or raise.</b>	Lift arm support device engaged. Lift solenoid valve malfunctioning.  Restraint bar not lowered. Seat or restraint bar switch malfunction.	Raise lift arm and disengage support device.  Check electrical connections to solenoid. Repair or replace as needed.  Lower restraint bar.  Check electrical connections to the switch. Replace switch as needed.

## Notes

---

# CHAPTER 7

## MAINTENANCE SCHEDULE

This Maintenance Interval Chart was developed to match the *Service* chapter of this manual. Detailed information on each service procedure can be found in the *Service* chapter. A Maintenance Log follows the chart for recording the maintenance performed. Recording the 10-hour (or daily) service intervals would be impractical and is therefore not recommended.

**Important:** Under severe operating conditions, more frequent service than the recommended intervals may be required. You must decide, based on your use, if your operation requires more frequent service.

### Maintenance Interval Chart

Service Procedure	Maximum Interval		
	10 Hours (or Daily)	250 Hours	500 Hours (or Yearly)
Check Engine Air Cleaner Restriction Indicator (page 45)	●		
Check Engine Oil Level (page 47)	●		
Check Hydraulic Oil Level (page 50)	●		
Check Tire Pressures (page 54)	●		
Grease Lift Arm, Hitch and Cylinder Pivots (page 44)	●		
Check Bucket Cutting Edge (page 49)	●		
Check Seat and Restraint Bar Operation (page 52)	●		
Check Coolant Level (page 51)	●		
Clean Cooling System (page 51)		●	
Check Wheel Nuts Torque (page 53)	○	●	
Check Oil Level in Chaincases (page 52)		●	
Clean Spark Arrestor Muffler (page 49)		●	
Check Alternator/Fan Belt Tensions (page 49)		●	
Change Engine Oil and Filter (page 48)	□		●
Change Hydraulic Oil Filter (page 50)	□		●
Check Battery (page 55)			●
Check Engine Mounting Hardware (page 47)			●
Change Fuel Filters (page 48)			●
Change Hydraulic Oil (page 50)			◆
Change Chaincase Oil (page 52)	□		◆
Drain/Flush Cooling System (page 51)			●

- Perform the initial procedure at 2 hours then at "●" intervals.
- Perform the initial procedure at 50 hours then at "●" intervals.
- ◆ Perform the maintenance at 1000 hours.







## Notes

---

# CHAPTER 8

## SPECIFICATIONS

### Loader Specifications

Specification	2026	2041
Operating Weight	4000 lbs. (1814 kg)	4600 lbs.(2087 kg)
Shipping Weight <sup>2</sup>	3515 lbs. (1594 kg)	4065 lbs. (1844 kg)
Rated Operating Load <sup>1</sup> (capacity)	1050 lbs. (476 kg)	1350 lbs. (612 kg)
Engine		
Make	Yanmar	Yanmar
Model	3TNV88-XMS2	4TNV88-XMS2
Displacement	100 in <sup>3</sup> (1.64 L)	133 in <sup>3</sup> (2.19 L)
Power (net)	35 hp (26 kW) @ 2600 rpm	46 hp (34 kW) @ 2600 rpm
Peak Torque	80 ft.-lbs. (108 N·m) @ 1200 rpm	103 ft.-lbs. (140 N·m) @ 1200 rpm
Hydraulic System (theoretical)		
Main Hydraulic System Pressure	2750 psi (190 bar)	2750 psi (190 bar)
Standard-Flow Rating	14.5 gpm (55 L/min)	16.5 gpm (62 L/min)
Electrical		
Battery	12-Volt DC, 675 CCA	12-Volt DC, 675 CCA
Starter	Electric	Electric
Alternator	40 amperes	40 amperes
Capacities		
Chaincase (each)	8 U.S. qts. (7.6 L)	8.0 U.S. qts. (7.6 L)
Crankcase	7.6 U.S. qts. (7.2 L)	9.1 U.S. qts. (8.6 L)
Fuel Tank	10.3 U.S. gal. (39 L)	12.4 U.S. gal. (47 L)
Hydraulic Reservoir	8 U.S. gal. (30 L)	8 U.S. gal. (30 L)
Sound (with Deluxe Sound Kit)		
Pressure Level (Operator Ear)	85 dB(A)	85 dB(A)
Power Level (Environmental)	101 dB(A)	101 dB(A)

1. Operating load (capacity) rated for 2026: 55 in. (1397 mm) 10.5 ft<sup>3</sup>, (0.3 m<sup>3</sup>);  
2041: 61 in. (1550 mm) 11.7 ft<sup>3</sup>, (0.3 m<sup>3</sup>) dirt/construction bucket, in accordance  
with SAE J818.

2. 2026 shipped with 27.0 x 8.50 - 15 tires; 2041 shipped with 10.00 x 16.5 tires

## Standard Features

---

- Choice control types:  
T-Bar or Hand/Foot
- Fuel Gauge
- All-Tach™ Attachment System  
(Universal-Type)
- Warning Lamps and Buzzer –  
Engine and Hydraulic  
Oil Temperature
- Battery Charge Indicator Lamp
- Low Oil Pressure Light and Buzzer
- Seatbelt Indicator Lamp and  
Buzzer
- Coolant Temperature Gauge
- Hourmeter
- Manual-Control Hydrostatic Drive
- ROPS/FOPS- Level II – Approved  
Overhead Guard
- Independent Hydraulic Reservoir  
and Hydraulic Oil Cooler
- Foot (T-Bar Only) and Hand Throttle
- Operator Restraint Bar  
with Armrests
- Engine Intake Air Pre-Heater  
Starting Assist (Manual)
- Adjustable Seatbelt
- Lift Arm Support Device
- Hydraloc™ System – Brakes and  
Interlock for Starter, Lift/Tilt  
Cylinders, Auxiliary Hydraulics,  
and Wheel Drives
- Dual Front and Rear Work Lights
- Removable Belly Plate and  
Access Cover
- Dual-Element Air Cleaner with  
Visual Indicator
- Vandalism Lock Provisions
- Top and Rear Windows
- Spark Arrestor Muffler
- Headliner and Acoustical Interior
- Adjustable Seat
- Front Auxiliary Hydraulics with  
3/4-inch Flat-Faced Couplers
- Number 80K Drive Chain
- Visual Hydraulic Filter Indicator
- Power Plug (12-volt)

## Optional Features

---

- Audible Back-Up Alarm
- Engine Block Heater
- Horn
- Suspension Seat
- Cab Door with Wiper and Dome  
Light
- Sliding Side Windows
- Heater/Defroster
- Deluxe Sound Package
- 3-inch Wide Seatbelt – When  
Required by Law
- Rear View Mirror
- Engine Auto-Shutdown System
- Interior Dome Light
- Centrifugal Pre-Cleaner
- Strobe Light
- Impact-Resistant Door
- Single-Point Lift Kit
- Four-Point Lift Kit
- Rear Counterweight
- Battery Disconnect Switch
- Bucket Bolt-On Cutting Edge
- Diesel Engine Exhaust Purifier
- Hydraulic Coupler Kit
- Self-Leveling Lift Action

## Dimensional Specifications

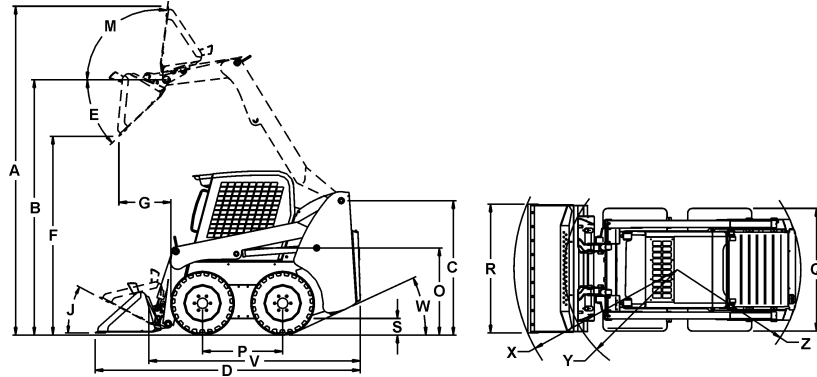

<b>2026</b>		<b>10.5 ft<sup>3</sup> (0.3 m<sup>3</sup>) Bucket w/27 x 8.5 x 15 Tires</b>	
		<b>inches</b>	<b>mm</b>
<b>A</b>	Overall Operation Height – Fully Raised	139.6	3546
<b>B</b>	Height to Hinge Pin – Fully Raised	108.1	2746
<b>C</b>	Overall Height – to ROPS	70.3	1786
<b>D</b>	Overall Length – Bucket Down	114.0	2896
<b>E</b>	Dump Angle at Full Height	42°	
<b>F</b>	Dump Height	84.5	2146
<b>G</b>	Dump Reach – Bucket Full Height	22.8	579
<b>J</b>	Rollback at Ground	29°	
<b>M</b>	Rollback Angle at Full Height	99°	
<b>O</b>	Seat to Ground Height	32.6	828
<b>P</b>	Wheel Base – Nominal	34.5	876
<b>Q</b>	Overall Width – Less Bucket	48.4/58.2	1229/1428
<b>R</b>	Bucket Width – Overall	55.3	1404
<b>S</b>	Ground Clearance – to Chassis (Between Wheels)	6.0	152
<b>V</b>	Overall Length (Less Bucket)	88.9	2258
<b>W</b>	Departure Angle	26°	
<b>X</b>	Clearance Circle – Front (With Bucket)	69.4	1763
<b>Y</b>	Clearance Circle – Front (Less Bucket)	44.1	1120
<b>Z</b>	Clearance Circle – Rear	54.1	1374

## Dimensional Specifications

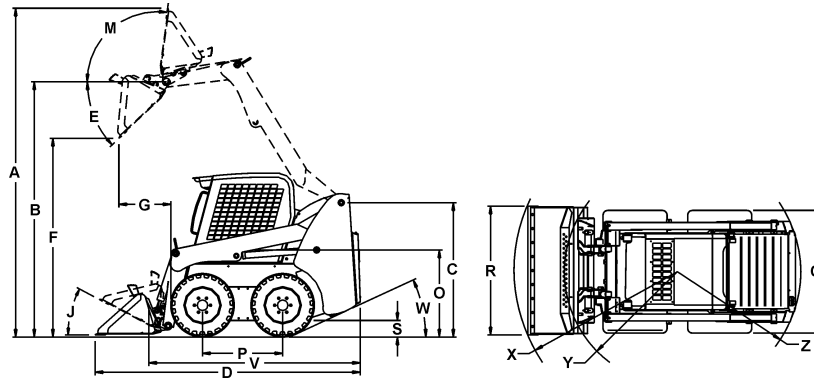

<b>2041</b>		<b>11.7 ft<sup>3</sup> (0.3 m<sup>3</sup>) Bucket w/10 x 16.5 Tires</b>	
		<b>inches</b>	<b>mm</b>
<b>A</b>	Overall Operation Height – Fully Raised	141.1	3584
<b>B</b>	Height to Hinge Pin – Fully Raised	110.0	2794
<b>C</b>	Overall Height – to ROPS	71.9	1826
<b>D</b>	Overall Length – Bucket Down	116.2	2952
<b>E</b>	Dump Angle at Full Height	42°	
<b>F</b>	Dump Height	86.5	2197
<b>G</b>	Dump Reach – Bucket Full Height	20.8	528
<b>J</b>	Rollback at Ground	29°	
<b>M</b>	Rollback Angle at Full Height	99°	
<b>O</b>	Seat to Ground Height	33.6	853
<b>P</b>	Wheel Base – Nominal	36.7	932
<b>Q</b>	Overall Width – Less Bucket	52.5/58.4	1334/1483
<b>R</b>	Bucket Width – Overall	60.6	1539
<b>S</b>	Ground Clearance – to Chassis (Between Wheels)	8.3	211
<b>V</b>	Overall Length (Less Bucket)	91.1	2314
<b>W</b>	Departure Angle	29°	
<b>X</b>	Clearance Circle – Front (With Bucket)	69.2	1758
<b>Y</b>	Clearance Circle – Front (Less Bucket)	43.4	1102
<b>Z</b>	Clearance Circle – Rear	58.4	1484

## Capacities and Ratings

*Note: Use the Table of Common Materials and Densities (page 76) for selecting the appropriate bucket.*

### Dirt/Construction Buckets

Description	Weight	Rated Operating Capacity	
		2026	2041
55 in./10.5 ft <sup>3</sup> (1397 mm/0.30 m <sup>3</sup> )	235 lbs. (107 kg)	1095 lbs. (497 kg)	1383 lbs. (627 kg)
60 in./10.0 ft <sup>3</sup> (1524 mm/0.28 m <sup>3</sup> )	252 lbs. (114 kg)	881 lbs. (340 kg)	1102 lbs. (500 kg)
61 in./11.7 ft <sup>3</sup> (1549 mm/0.33 m <sup>3</sup> )	253 lbs. (115 kg)	1082 lbs. (491 kg)	1370 lbs. (621 kg)

### Construction with High Back Buckets

55.5 in./9.5 ft <sup>3</sup> (1410 mm/0.27 m <sup>3</sup> )	254 lbs. (115 kg)	1061 lbs. (481 kg)	1325 lbs. (601 kg)
61.5 in./13.0 ft <sup>3</sup> (1562 mm/0.37 m <sup>3</sup> )	383 lbs. (174 kg)	975 lbs. (422 kg)	1214 lbs. (551 kg)

### Utility Buckets

55.5 in./13.5 ft <sup>3</sup> (1410 mm/0.38 m <sup>3</sup> )	313 lbs. (142 kg)	1061 lbs. (481 kg)	1325 lbs. (601 kg)
61.5 in./15.2 ft <sup>3</sup> (1562 mm/0.43 m <sup>3</sup> )	335 lbs. (152 kg)	826 lbs. (375 kg)	1064 lbs. (483 kg)
67 in./18.4 ft <sup>3</sup> (1701 mm/0.52 m <sup>3</sup> )	395 lbs. (179 kg)	795 lbs. (361 kg)	1000 lbs. (454 kg)

### Earth and Foundry Bucket

61.5 in./10.9 ft <sup>3</sup> (1562 mm/0.31 m <sup>3</sup> )	331 lbs. (150 kg)	1228 lbs. (557 kg)	1469 lbs. (666 kg)
--	----------------------	-----------------------	-----------------------

### Pallet Forks

15.75 in. (400 mm) Forks with Backrest Rating per EN474-3	470 lbs. (213 kg)	662 lbs. (300 kg)	838 lbs. (380 kg)
19.68 in. (500 mm) Forks with Backrest Rating per EN474-3	470 lbs. (213 kg)	616 lbs. (279 kg)	775 lbs. (352 kg)
24 in. (670 mm) Forks with Backrest Rating per SAE J1197	470 lbs. (213 kg)	575 lbs. (261 kg)	526 lbs. (239 kg)

## Table of Common Materials and Densities

Material	Density	
	lbs/ft <sup>3</sup>	kg/m <sup>3</sup>
Ashes	35-50	560-800
Brick-common	112	1792
Cement	110	1760
Charcoal	23	368
Clay, wet-dry	80-100	1280-1600
Coal	53-63	848-1008
Concrete	115	1840
Cinders	50	800
Coal-anthracite	94	1504
Coke	30	480
Earth-dry loam	70-90	1121-1442
Earth-wet loam	80-100	1281-1602
Granite	93-111	1488-1776
Gravel-dry	100	1602
Gravel-wet	120	1922
Gypsum-crushed	115	1840
Iron ore	145	2320
Lime	60	960
Lime stone	90	1440
Manure-liquid	65	1040
Manure-solid	45	720
Peat-solid	47	752
Phosphate-granular	90	1440
Potash	68	1088
Quartz-granular	110	1760
Salt-dry	100	1602
Salt-Rock-solid	135	2160
Sand-dry	108	1728
Sand-wet	125	2000
Sand-foundry	95	1520
Shale-crushed	90	1440
Slag-crushed	70	1120
Snow	15-50	240-800
Taconite	107	1712

*Note: The densities listed are average values and intended only as a guide for bucket selection. For a material that is not in the table, obtain its density value before selecting the appropriate bucket.*



## Bucket Selections

---

To use the table, find the material name and see what its maximum density is. Then, multiply the loader rating of the attachment by the material density to determine if the attachment can safely be used. See page 75 for a listing of attachments and their loader ratings.

*Note: Where the material density is listed as a range (snow at 15-50 lbs./ft<sup>3</sup>, for example), always use the maximum density (50 lbs./ft<sup>3</sup> in this example) for making calculations. Also, see the following examples.*

**Example 1:** If snow (density of 15-50 lbs./ft<sup>3</sup>) is to be hauled using a 2026 model loader using Dirt/Construction Bucket, the bucket capacity is 10.5 ft<sup>3</sup> and the loader rating is 1050 lbs. Multiply the density of snow (50 lbs./ft<sup>3</sup>) by the capacity of the bucket (10.5 ft<sup>3</sup>) to achieve the weight being carried (50 lbs./ft<sup>3</sup> x 10.5 ft<sup>3</sup> = 525 lbs.). This number is less than the machine rating, so you could safely use this bucket in this application.

**Example 2:** If potash (density of 1088 kg/m<sup>3</sup>) is to be hauled using a 2026 model loader using a 0.3 m<sup>3</sup> Dirt/Construction bucket, the bucket capacity is 0.3 m<sup>3</sup> and the loader rating is 612 kg. Multiply the density of potash (1088 kg/m<sup>3</sup>) by the capacity of the bucket (0.3 m<sup>3</sup>) to achieve the weight to be carried (1088 kg/m<sup>3</sup> x 0.3 m<sup>3</sup> = 326.4 kg). This number is less than the machine rating, allowing safe use of this bucket in this application.

## Notes

---

# CHAPTER 9

## TORQUE SPECIFICATIONS

Use these torque values when tightening hardware (excluding: locknuts, and self-tapping, thread forming, and sheet metal screws) unless otherwise specified.

UNIFIED NATIONAL THREAD	GRADE 2		GRADE 5		GRADE 8	
	DRY	LUBED	DRY	LUBED	DRY	LUBED
8-32	19*	14*	30*	22*	41*	31*
8-36	20*	15*	31*	23*	43*	32*
10-24	27*	21*	43*	32*	60*	45*
10-32	31*	23*	49*	36*	68*	51*
1/4-20	66*	50*	9	75*	12	9
1/4-28	76*	56*	10	86*	14	10
5/16-18	11	9	17	13	25	18
5/16-24	12	9	19	14	25	20
3/8-16	20	15	30	23	45	35
3/8-24	23	17	35	25	50	35
7/16-14	32	24	50	35	70	55
7/16-20	36	27	55	40	80	60
1/2-13	50	35	75	55	110	80
1/2-20	55	40	90	65	120	90
9/16-12	70	55	110	80	150	110
9/16-18	80	60	120	90	170	130
5/8-11	100	75	150	110	220	170
5/8-18	110	85	180	130	240	180
3/4-10	175	130	260	200	380	280
3/4-16	200	150	300	220	420	320
7/8-9	170	125	430	320	600	460
7/8-14	180	140	470	360	660	500
1-8	250	190	640	480	900	680
1-12	270	210	710	530	1000	740
<b>METRIC COARSE THREAD</b>						
	GRADE 8.8		GRADE 10.9		GRADE 12.9	
	DRY	LUBED	DRY	LUBED	DRY	LUBED
M6-1	8	6	11	8	13.5	10
M8-1.25	19	14	27	20	32.5	24
M10-1.5	37.5	28	53	39	64	47
M12-1.75	65	48	91.5	67.5	111.5	82
M14-2	103.5	76.5	145.5	108	176.5	131
M16-2	158.5	117.5	223.5	165.5	271	200

\*All Torque Values are in ft-lbs. except those marked with an \*, which are in-lbs.  
For metric torque value (N-m), multiply ft-lbs. value by 1.355 or the in-lbs. value by 0.113.

**MUSTANG MANUFACTURING COMPANY, INC.**  
**WARRANTY**

MUSTANG MANUFACTURING COMPANY, INC., hereinafter referred to as Mustang, warrants new Mustang equipment to the Original Retail Purchaser to be free from defects in material and workmanship for a period of twelve (12) months from the Warranty Start Date.

**MUSTANG WARRANTY SERVICE INCLUDES:**

Genuine Mustang parts and labor costs required to repair or replace equipment at the selling dealer's business location.

---

**MUSTANG MAKES NO REPRESENTATIONS OR WARRANTIES OF ANY KIND, EXPRESS OR IMPLIED (INCLUDING THE IMPLIED WARRANTIES OF MERCHANTABILITY AND FITNESS FOR PARTICULAR PURPOSE), EXCEPT AS EXPRESSLY STATED IN THIS WARRANTY STATEMENT.**

ANY OF THESE LIMITATIONS EXCLUDED BY LOCAL LAW SHALL BE DEEMED DELETED FROM THIS WARRANTY; ALL OTHER TERMS WILL CONTINUE TO APPLY.

SOME STATES DO NOT PERMIT THE EXCLUSION OR LIMITATION OF THESE WARRANTIES AND YOU HAVE GREATER RIGHTS UNDER THE STATE LAW.

---

**MUSTANG WARRANTY DOES NOT INCLUDE:**

1. Transportation to selling dealer's business location or, at the option of the Original Retail Purchaser, the cost of a service call.
2. Used equipment.
3. Components covered by their own non-Mustang warranties, such as tires, batteries, trade accessories and engines.
4. Normal maintenance service and expendable, wear-out items.
5. Repairs or adjustments caused by: improper use; failure to follow recommended maintenance procedures; use of unauthorized parts or attachments; accident or other casualty.
6. Liability for incidental or consequential damages of any type, including, but not limited to lost profits and expenses of acquiring replacement equipment.

No agent, employee or representative of Mustang has any authority to bind Mustang to any warranty except as specifically set forth herein.

# INDEX

<b>A</b>		Cooling System . . . . .	51
Accessory Plug . . . . .	22	Check Coolant Level . . . . .	51
Adjustments . . . . .	43	Clean . . . . .	51
Control Handles . . . . .	43	Drain/Flush . . . . .	51
Drive Chains . . . . .	44	<b>D</b>	
Engine Speed Control . . . . .	44	Dealer Services . . . . .	41
Fuel Sender . . . . .	43	<b>E</b>	
Alternator/Fan Belt . . . . .	49	Emergency Exit . . . . .	20
Attachments . . . . .	29, 34	Engine Air Cleaner . . . . .	45
Auxiliary Hydraulic Controls . . . . .	28	Engine Mounting Hardware . . . . .	47
Hand/Foot Controlled . . . . .	29	Engine Service . . . . .	45
T-Bar Controlled . . . . .	28	Change Fuel Filter . . . . .	48
<b>B</b>		Change Oil and Filter . . . . .	48
Battery . . . . .	55	Check Oil . . . . .	47
Jump Starting the Engine . . . . .	32	Engine Speed Control . . . . .	23
Bucket Cutting Edge . . . . .	53	<b>G</b>	
Bucket, Usage . . . . .	35	Guards and Shields . . . . .	17
Digging with a Bucket . . . . .	36	<b>H</b>	
Driving on an Incline . . . . .	35	Hand/Foot Controls . . . . .	27
Driving over Rough Terrain . . . . .	35	Drive Controls . . . . .	27
Dumping Into a Box . . . . .	37	Lift/Tilt Controls . . . . .	27
Dumping Onto a Pile . . . . .	36	Highway Travel . . . . .	38
Dumping the Load Over an Embankment . . . . .	37	Hydraulic System . . . . .	50
Leveling the Ground . . . . .	37	Change Oil . . . . .	50
Loading a Bucket . . . . .	36	Change Oil Filter . . . . .	50
Scraping with a Bucket . . . . .	37	Check Oil Level . . . . .	50
<b>C</b>		<b>I</b>	
Capacities and Ratings . . . . .	75	Instrument Panel . . . . .	24
Chaincases . . . . .	52	INTRODUCTION . . . . .	1
Checking and Adding Oil . . . . .	52	<b>L</b>	
Draining Oil . . . . .	52	Lift Arm Support Device . . . . .	20
Circuit Breakers . . . . .	54	Loader	
Cold Starting Procedure . . . . .	31	Lifting . . . . .	38
Control/Indicator Symbols . . . . .	3	Lowering Procedure . . . . .	42
CONTROLS and SAFETY EQUIPMENT . . . . .	17	Raising Procedure . . . . .	42
		Storing . . . . .	39
		Transporting . . . . .	39

Lubrication .....	44	Table of Common Materials and Densities .....	76
<b>M</b>			
MAINTENANCE SCHEDULE .	67	T-Bar Controls .....	26
Maintenance Log .....	68	Drive Controls .....	26
Mandatory Safety Shutdown Procedure .....	6	Lift/Tilt Controls .....	26
Model Identification .....	2	Tires .....	53
<b>O</b>			
OPERATION .....	31	Checking Tire Pressure . . .	54
Operator Restraint Bar .....	17	Mounting Tires .....	53
Operator's Seat .....	18	TORQUE SPECIFICATIONS .	79
<b>P</b>			
Parking Brake .....	19	TROUBLESHOOTING .....	57
Parking the Loader .....	32	Electrical System .....	57
Potential Hazards .....	8	Engine .....	59
<b>R</b>			
Rear Window .....	20	Hydraulic System .....	63, 64, .....
ROPS/FOPS .....	19	Hydrostatic System .....	60, 62
<b>S</b>			
SAFETY .....	5	<b>W</b>	
Safety Decals .....	8	WARRANTY .....	80
New Decal Application . . . .	8	Wheel Nuts .....	53
No-Text Decals .....	12		
Safety Interlock System .....	18		
Testing .....	18		
Safety Reminders .....	6		
Self-Leveling .....	35		
SERVICE .....	41		
Spark Arrestor Muffler .....	49		
SPECIFICATIONS .....	71		
Accessories .....	72		
Standard Features .....	72		
Starting the Engine .....	31		
Before Starting the Engine .....	31		
Stopping the Loader .....	32		
Switches, Seat and Restraint Bar .....	52		
<b>T</b>			
Table of Common Materials & Densi- ties .....	76		

WRONG

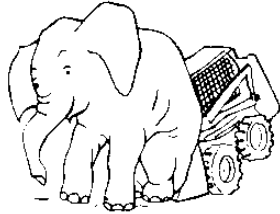

 Never exceed rated operating load.

WRONG

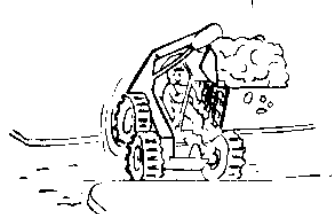

 Always carry attachment as low as possible. Do not travel or turn with the lift arm raised. Load, unload and turn on flat level surface.

WRONG

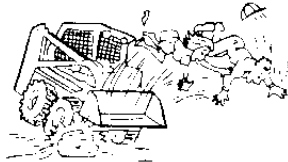

 Never carry riders.

 Keep bystanders away from work area.

WRONG

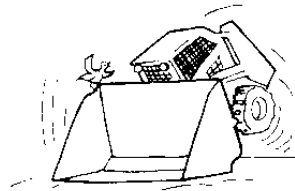

 Never modify equipment.

 Use only attachments approved for the loader.

WRONG

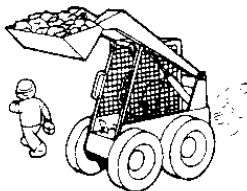

 Never leave loader with engine running or with lift arm up. To park, engage parking brake and put attachment flat on the ground.

**California Proposition 65 Warnings**

Diesel engine exhaust and some of its constituents are known to the State of California to cause cancer and birth defects or other reproductive harm.

Battery posts, terminals and related accessories contain lead and lead compounds, chemicals known to the State of California to cause cancer and birth defects or other reproductive harm. Wash hands after handling battery.