



User manual **EN**

Chest freezer

ECF24460W

ECF27460W

ECF35460W

We were thinking of you
when we made this product

Electrolux. Thinking of you.

Share more of our thinking at www.electrolux.com



Disposal

By ensuring this product is disposed of correctly, you will help prevent potential damaging consequences for the environment and human health.

The symbol on the product indicates that this product may not be treated as household waste, instead it should be taken to the appropriate collection point for the recycling of electrical and electronic equipment. For more detailed information about recycling of this product, please contact your local council, your household waste disposal service or the shop where you purchased the appliance.

Contents

Safety Information	4	Daily use	6
Product Description	4	Care and Cleaning	6
Control panel	4	Helpful hints and tips	7
Display	5	What to do if..	8
Installation	5	Service or repair	9
Electrical connection	5	Technical Data	9
First use	5	Guarantee/Customer Service	10
Switch on-off	5	European Guarantee	11



Safety Information

Before installing and using the appliance read this user's instruction book carefully. It contains safety precautions, hints, information and ideas. If the freezer is used in compliance with the instructions written, it will operate properly and provide you with the greatest satisfaction. These warnings are provided in the interest of safety. You must read them carefully before installing or using the appliance.

- Use the freezer only for storing frozen food, freezing fresh food and making ice cubes.
- Do not eat ice cubes or ice lollies immediately after taking them out of the freezer, as they may cause frost burns.
- Do not allow children to play or hide inside the freezer, as they may become trapped inside and suffocate.
- Do not store glass containers with liquids in the freezer, as they may burst.
- Ensure that the freezer is not resting on the power supply cable.
- Before servicing or cleaning, always unplug the appliance or disconnect the power supply.
- Do not use other electrical appliances (such as ice cream makers) inside the appliance.
- Your appliance contains an environmentally friendly natural gas, isobutane (R600a). Caution is required however, since isobutane is flammable. Therefore it is essential to ensure that the refrigerant pipelines are not damaged.

It is most important that this instruction book should be retained with the appliance for future reference.

Product Description

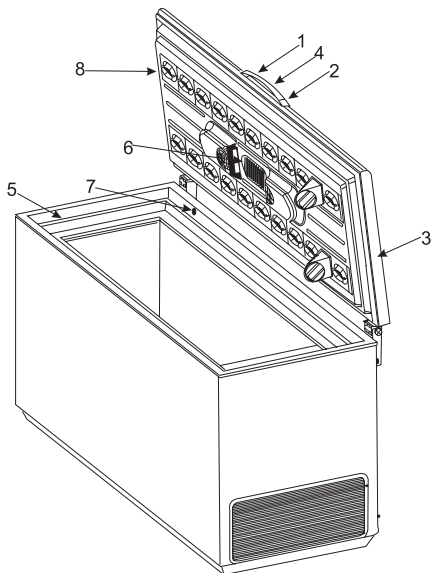

1. Lid handle
2. Security lock
3. Seal
4. Control panel
5. Upper edge
6. Light
7. Valve: easy re-opening of lid
8. Frost Free system: totally eliminates ice-build-up in the chest freezer

Control panel

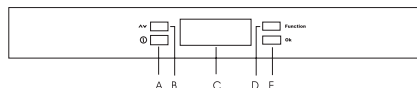

- A - Appliance ON/OFF button
- B - Temperature regulation button
- C - Display
- D - Function button
- E - Confirmation button

Display



****** Indicates the appliance is switched on, speeds up when the Super Freeze function is activated.

! Indicates that the freezer temperature is not sufficiently low or that the lid has been left open.

SUPER Indicates the Super Freeze function is activated for large quantities for fresh food and switches off the beeping alarm.

! Indicates the Drinks Chill function is activated.

! Indicates the Eco Mode function is activated.

! Indicates the Child Lock function is activated.

-00 Indicates the temperature inside the freezer.

00_m Indicates the number of minutes drinks are to be chilled for, when the Drinks Chill function is active.

Installation

- Wait at least 2 hours before connecting the freezer to the power supply to ensure the refrigerant circuit is fully efficient.
- Install the freezer in a dry, well ventilated room. Avoid locations near a source of heat or in direct sunlight.
- The room temperature should correspond to the climatic classification for which the freezer was designed, see chapter "Technical data".
- Place the freezer horizontally on a firm surface, resting on all four feet.

- For optimum operation and in order to avoid damage when the lid is opened, leave a space of at least 5 cm from the rear wall and 5 cm at the sides.
- Before connecting the freezer to the power supply, ensure that the voltage corresponds to that indicated in chapter "Technical data" under "Voltage".



Danger!

- Ensure that the freezer is not resting on the power supply cable.
- Do not remove the power supply cable by pulling on its lead, particularly when the freezer is being pulled out of its niche.
- The power supply cable may only be replaced by a competent service personnel.
- Ensure that the power plug is not squashed or damaged by the back of the freezer.
- There must be adequate ventilation around the appliance.
- Any electrical work required to install this appliance should be carried out by a competent electrician.

Electrical connection

The appliance is supplied with a 13amp plug fitted. In the event of having to change the fuse in the plug supplied, a 13amp ASTA approved (BS1362) fuse must be used. Should the plug need to be replaced for any reason. The wires in the power supply cable are coloured in accordance with the following code:

- Green and Yellow - Earth: must be connected to the terminal marked with the letter "E" or by the earth symbol or coloured green and yellow.
- Blue - Neutral: must be connected to the terminal "N" or coloured black.

- Brown - Live: must be connected to the terminal marked "L" or coloured red.

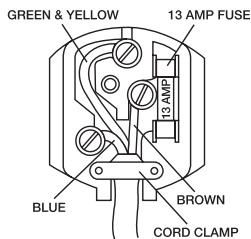

Upon completion there must be no cut, or stray strands of wire present and the cord clamp must be secure over the outer sheath.



Warning! This appliance must be earthed.

First use

- Before first use, the freezer should be cleaned inside, see chapter "Care and cleaning".
- Plug in the appliance.
- Press button (A) to switch the appliance on.
- The display will illuminate.
- The symbol (⚠) will flash on the display and the alarm will beep, since the temperature inside the freezer is not yet sufficiently low for food storage.
- Press button (E) to switch the alarm off. The symbol (⚠) will normally stop flashing after several hours.
- Only place food inside the freezer once the symbol (⚠) has gone. The temperature of the freezer is set to reach -18°C , which is the optimal storage temperature as set in the Eco Mode (☉)

Switch on-off

Switch on the freezer

- Press button (A) to switch the appliance on.
- The display comes on.

Switch off the freezer

- Press button (A) for more than one second until the countdown "3-2-1" disappears and you hear a sequence of beeps.
- The display goes off.

Warning! Do not place objects on the control panel, as they might accidentally switch off the freezer.

Daily use

Temperature adjustment

The temperature may be adjusted between -15°C and -24°C . We suggest setting the freezer temperature to -18°C , which guarantees proper freezing and conservation of frozen food.



- Press button (B) several times until the desired temperature is reached.
- The temperature on the display flashes and indicates the temperature set.
- Press button (E) to confirm the desired temperature. You will hear a beep.
- The temperature on the display stops flashing again and indicates the temperature inside the freezer.
- The newly adjusted temperature is reached after several hours. During this time it is normal that the temperature displayed is different from the temperature set.

Attention! Differences between the temperature displayed and the temperature set are normal, especially when:

- The temperature setting has recently been adjusted.
- The lid has been left open for a long time.
- Warm food has been placed in the freezer.
- The Super Freeze function is activated.



Super Freeze function



If more than 3-4 kg of fresh food is to be frozen, the freezer needs to be pre-cooled.

- At least 24 hours before placing fresh food in the freezer, press button (D) several times until the corresponding symbol () flashes on the display.
- Press button (E) within a few seconds to confirm the Super Freeze activation. The symbol () stops flashing, you will hear a beep and the animation on the display speeds up.
- Place the food in the freezer. After 52 hours this function will automatically stop and the freezer will return to normal storage temperature. This function can be de-activated at any time by pressing button (D) until the corresponding symbol () flashes on the display again and then by pressing button (E) to confirm the de-activation.

Drinks Chill function



Use this function as a safety warning when placing bottles in the freezer, as they may burst when forgotten in the appliance.

- Press button (D) several times until the corresponding symbol () flashes on the display.
- Press button (E) within a few seconds to confirm the Drinks Chill activation. The symbol () stops flashing and you will hear a beep.

- Press button (B) several times or continuously to set the desired number of minutes (from 1 to 90 minutes).
- Place the drinks in the freezer.
- At the end of the set time, the alarm will beep and the symbol () and the time will flash on the display.
- Press button (E) to switch the alarm off.
- Remove the drinks from the freezer. It is possible to de-activate this function at any time by pressing button (D) until the corresponding symbol () flashes on the display again and then by pressing button (E) to confirm the de-activation.



Eco Mode function

Use this function to automatically set the freezer temperature to its best level (- 18°C), which guarantees proper conservation of frozen food at the lowest energy consumption.

- Press button (D) several times until the corresponding symbol () flashes on the display.
- Press button (E) within a few seconds to confirm the Eco Mode activation. The symbol () stops flashing and you will hear a beep. It is possible to de-activate this function at any time by pressing button (B) to change the selected temperature and then by pressing button (E) to confirm the selection.

Child Lock function

This function prevents children from playing with the buttons on the control panel. Any possible pressing of the buttons will have no effect.

- Press button (D) several times until the corresponding symbol () flashes on the display.
- Press button (E) within a few seconds to confirm the Child Lock activation. The symbol () stops flashing and you will hear a beep.
- The buttons on the control panel are now locked. It is possible to deactivate this function at any time by pressing button (D) until the corresponding symbol () flashes on the display again and then by pressing button (E) to confirm the deactivation.

Alarm

If the freezer temperature is not sufficiently low, the alarm will beep and the symbol () and the temperature indication will flash on the display. When normal conditions are restored, only the freezer temperature continues to flash. The highest temperature the freezer reached is memorised.

- Press button (E) to switch the alarm off. The highest temperature the freezer reached then appears on the display for some seconds. Then the

display returns to showing the temperature of the freezer.

- The symbol () remains on as long as the temperature in the freezer is higher than the temperature set.

The alarm can be due to:

- Insertion of a large amount of fresh food.
- Opening the lid too long.
- A defect in the system, see chapter "What to do if...".

Storage baskets

- Hang the baskets on the upper edge (X) or place the stackable baskets inside the freezer (Y).
- Turn and fix the handles for these two positions, as shown in the drawings.

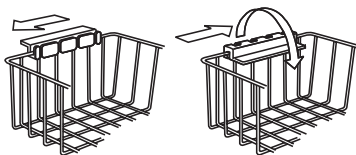

Spare baskets can be obtained from your local Service Force Centre or from the Electrolux website (depending on country). The illustrations on this page show how many baskets can be placed in the various freezer models.



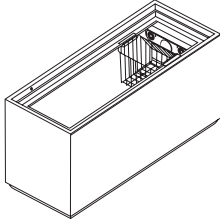

Fast freezing basket

The basket is designed for fast freezing. Important! Never remove this special basket that protects the Frost Free system.



Security lock

The freezer is equipped with a special lock in order to avoid accidental locking. The lock is designed in such manner that you can turn the key and thus close the lid only if you previously push the key into the lock.

- In order to close the freezer, gently push the key into the lock and turn it clockwise towards the symbol .
- In order to open the freezer, gently push the key into the lock and turn it counter-clockwise towards the symbol .

Spare keys are available at the local service center.

Keep the key out of reach of children.

Prior to disposing of your old freezer, remove the key from the lock.

Making ice cubes

- Hold the ice cube tray vertically and fill it with water upto the marked max. line (F).
- Close the ice cube tray with the cap (G) and slide the tray in the lid of the freezer.
- To loosen the ice cubes, either twist

the tray or hold it under running water for a few seconds.

Important! Never use sharp or pointed instruments to remove the ice cube tray

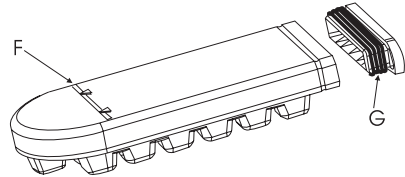

Opening and closing the lid

As the lid is fitted with a tightly closing seal, it will not re-open easily immediately after closing.

- Wait a few minutes before re-opening the lid. The valve will allow the lid to be re-opened easily. Never pull the handle with immense force.

Care and Cleaning

Cleaning

- Disconnect the appliance from the power supply.
- Remove all loose accessories and the vented floor, as shown on the illustration.
- Use a damp cloth to clean your freezer. Use hot water and a mild, non-aromatic detergent.
- Clean the loose accessories and the vented floor, before replacing them again.

Important! Never use strong detergents, scouring powder or aromatic detergents to clean your freezer.

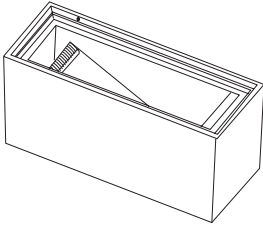

When not in use

- Disconnect the appliance from the power supply.
- Remove all food from the freezer.
- Clean the freezer as described above.
- Leave the lid slightly open.

Changing the light bulb

Helpful hints and tips

Freezing food

- Before freezing, fresh food must be packed in airtight and moisture-proof packaging to prevent it from drying out.
- Only use fresh food of the best quality.
- Always leave hot food to cool to room temperature before placing in the freezer.
- Divide food into small portions before freezing; this ensures that freezing is more rapid, and that you only need to defrost the amount needed for immediate consumption.
- Mark the freezer packaging with the date of freezing.
- Place fresh food for freezing close to the cold sides of the freezer, making sure that it is not in contact with the frozen food already in the freezer.
- Frozen food can be stored anywhere inside the freezer, but should be kept at least 5 mm below the upper edge.

Never fill the freezer further than the loading line shown on the illustration.

If freezing is too slow, the quality of the food being frozen deteriorates. The amount of fresh food (expressed in kg) that can be frozen in 24 hours is indicated in the chapter "Technical data" under "Freezing capacity".

Food storage

- For fresh frozen food, please refer to the storage period table underneath.
- For purchased frozen food, never exceed the expiry date.
- When you buy frozen food, make sure that it has been stored at the correct temperature. Do not buy products which have wet or damaged packaging. Place purchased products in your freezer as quickly as possible. We recommend using an insulated bag to bring such products home with you.

Important! Remember that fully or partially defrosted food must not be refrozen. However, dishes which have been cooked using defrosted food may be frozen.



In the case of a power failure or breakdown

- Do not open the lid.

Important! If the power has been off for longer than the value shown in the chapter "Technical data" under "Hold-over time", the defrosted food must be consumed quickly or cooked immediately and then refrozen (after cooling).

What to do if...

Try the solutions suggested here first to avoid the cost of an unnecessary service call.

Your freezer will not operate

- Is the power supply cord unplugged?
- Has a household fuse blown?
- Is there a power failure?
- Is the temperature control set to the Off position?

The alarm remains audible and/or the red light/symbol () is on

- Is the lid not closed completely? See underneath.
- Is the temperature control set correctly for the surrounding conditions?
- Is the freezer too close to a source of heat?

The inside light does not work

- Is the power supply cord unplugged?
- Is the light bulb loose in the socket or burned out?

The motor seems to run too much

- Is the lid not closed completely? See underneath for any obstructions.
- Is the room temperature hotter than normal?
- Has a large amount of fresh food just been added to the freezer?
- Is the lid opened often?
- Is the temperature control set correctly for the surrounding conditions?

- Is the lid seal damaged or deformed?
- Is there enough air circulation space around the freezer?
- Is the Super Freeze function activated accidentally?

Temperature is too warm

- Has a large amount of food just been added to the freezer?
- Is the lid opened often?
- Is the temperature control set correctly for the surrounding conditions?

The lid will not close completely

- Is there excessive frost or a package preventing the lid from closing?
- Are food packages blocking the lid?
- Is the lid seal dirty or sticky?
- Does the freezer wobble or seem unstable?

The lid is difficult to open

- Is the lid seal dirty or sticky?
- Is the valve blocked?

If you still need help, please contact your local Service Force Centre.

Service or repair

In cases of breakdown or faults, your freezer must be serviced by an authorized Electrolux Service Centre.

Important! Under no circumstances should you attempt to repair the appliance yourself

Technical Data

Model		BMI265 ECF24460W	BMI310 ECF27460W	BMI390 ECF35460W
Volume (gross)	Liter	261	299	378
Volume (net)	Liter	255	292	3368
Height	Cm	87,6	87,6	87,6
Width	Cm	119	132,5	160
Depth	Cm	66,5	66,5	66,5
Weight	Kg	57	63	68
Energy consumption/24h	kWh/24h	0,649	0,696	0,792
Freezing capacity	kg/24h	27	28	29
Hold-over time	Hours	50	52	55
Rated power	Watt	100	120	140
Voltage	Volts	230	230	230
Climatic class		SN/N/ST	SN/N/ST	SN/N/ST

Climatic classification	Ambient temperature limits
SN	from +10°C to +32°C
N	from +16°C to +32°C
ST	from +18°C to +38°C
T	from +18°C to +43°C

 This appliance complies with the following EC Directives:

73/23/EEC of 19. 02. 1973 Low-Voltage Directive

89/336/EEC of 03. 05. 1989 (including Amendment Directive 92/31/EEC - EMC Directive)

www.electrolux.com

www.electrolux.en