

OPERATING INSTRUCTIONS & SERVICE MANUAL

STEREO CONTROL AMPLIFIER

SANSUI AU-70

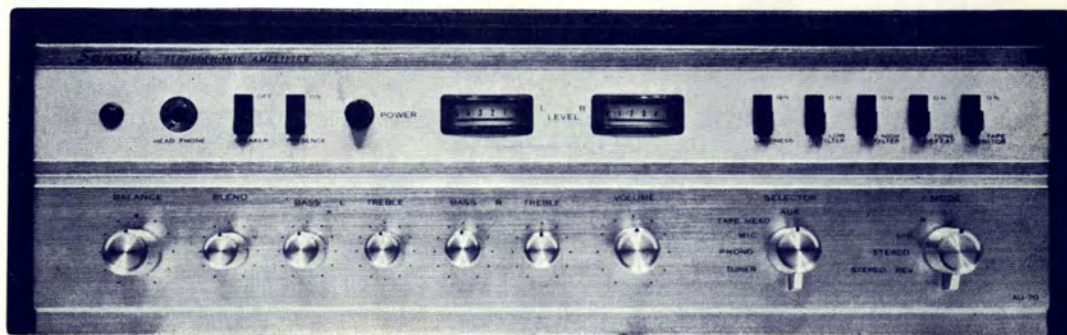

Sansui

SANSUI ELECTRIC COMPANY LIMITED

OPERATING INSTRUCTIONS & SERVICE MANUAL

This amplifier has a maximum output of 50 watts (25W-25W) and features an amazingly low distortion factor of not more than 0.15% at 20W. A high-quality amplifier with many exciting features, it is delivered to you with Sansui's fullest confidence. This booklet explains the steps necessary for operating and caring for your new the AU-70. Read all the instructions carefully and retain for future use.

CONTENTS

FEATURES.....	3, 4
SPECIFICATIONS	5
CHARACTERISTICS	6
CONNECTIONS	7, 8, 9, 10
SWITCHES AND CONTROLS	11, 12
OPERATIONS	13, 14
HINTS ON USE	15, 16
SERVICE NOTE	17, 18
PARTS LIST	19, 20, 21
SCHEMATIC DIAGRAM	22
PARTS LAYOUT	23

SANSUI

STEREO CONTROL AMPLIFIER



AU-70

FEATURES

7189A P.P. PRODUCES 40W WITHOUT DISTORTION (MAX. 0.95% AT 30 CPS AND 0.15% AT 1,000 CPS)

The 7189A power tubes operate in class AB₁P.P. (fixed bias) for high-fidelity reproduction. Their combined maximum output is limited to 50 W. The amplifier incorporates a multiplex feedback circuit (total negative feedback: 26 dB) for the first time in this class of amplifiers in Japan. This makes it extremely low in distortion over the whole frequency range. Total harmonic distortion at 1 kc is 0.15%. At 30 cps, a very low frequency at which it is extremely difficult to minimize harmonic distortion, the distortion is limited to not more than 0.95%. This is quite a feat for a 50-watt amplifier. Another remarkable feature is the damping factor of 18, a figure which is lower than that of triode power tubes coupled in P.P. This is why bass sounds come out with such clarity.

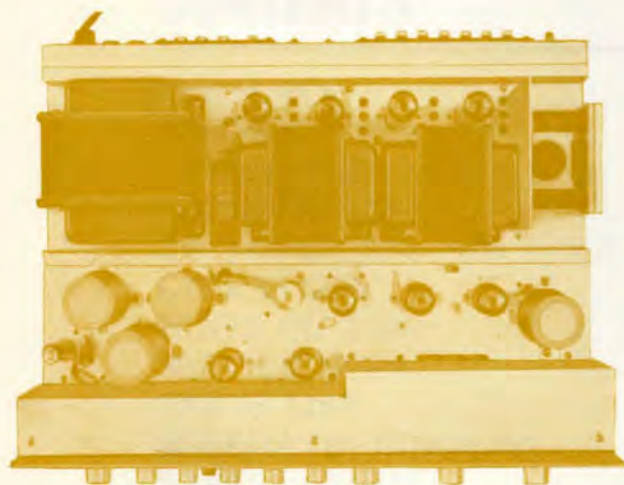

NFB USED IN ALL AMPLIFIER CIRCUITS, FROM PREAMP TO POWER AMPLIFIER

The low distortion of the power amplifier is meaningless if the preamplifier generates distortions. Your AU-70 uses a three-stage amplifier circuit in its intermediate or control amplifier—unlike conventional one-stage control amplifiers—and has all its circuits in a single negative-feedback loop. These make your AU-70 free from noise and distortion.

SUPER-PRECISION TRANSISTOR PREAMPLIFIER ELIMINATES HUM AND NOISE

The exclusive Sansui four-transistor preamplifier, which features a transistor circuit factor of 4—as compared with conventional 5-10—and a transistor noise factor of 2 dB—as compared with conventional 5 dB, eliminates hum and noise, the enemy of high-fidelity reproduction. The amplifier has a much better S/N ratio and a gain three times larger than vacuum-tube amplifiers.

EACH CHANNEL CAN BE OPERATED INDEPENDENTLY EQUIPPED WITH TONE DEFEAT

Each channel has independent tone controls for bass and treble. This makes fine adjustment possible. Moreover, each channel is equipped with tone defeat which cancels the tone control circuits. You can easily obtain a flat frequency response without causing any undulation in response or reduced gain in bass and treble as in the case of conventional mechanical control by means of a tone volume knob. Therefore, you can get an accurate, perfectly flat response from your AU-70 just by flipping a switch.



BLEND CIRCUIT PERMIT CONTINUOUS SHIFT FROM MONAURAL TO STEREO

As you turn the "BLEND" switch clockwise, your AU-70 gradually shifts from monaural to stereophonic reproduction. This feature enables you to get full stereophonic effect by compensating program sources which give a particularly strong effect of the concert hall.



EASY-TO-READ THREE-RANGE OUTPUT LEVEL METERS

Each output level meter can be switched over to any of the three scales of 5, 10 and 25 watts. The meters not only give direct readings of both channels, but also indicate any lack of balance between the right and left outputs. These prove very useful in balancing the outputs.

THREE-DIMENSIONAL PERFORMANCE POSSIBLE WITH CENTER-CHANNEL OUTPUT TERMINAL

Your AU-70 has an output terminal for the center-channel amplifier. Connect it to your monaural amplifier to produce a three-dimensional effect.

EQUIPPED WITH ADVANCED, HIGH-PERFORMANCE ACCESSORY CIRCUITS

Your AU-70 is equipped with various advanced accessory circuits such as loudness control, low and high filters, tape monitor, tone defeat, presence, blend, speaker switch and headphone jack.

SPECIFICATIONS

MAIN AMPLIFIER:

MAXIMUM OUTPUT: 25W-25W (50W total)

HARMONIC DISTORTION:

Max. 0.15% at 20W for 1,000 Hz

Max. 0.95% at 20W for 30 Hz

INTERMODULATION

DISTORTION: Max. 0.85% at 20W, (50 Hz + 5,500 Hz)

FREQUENCY RESPONSE: 10-80,000 Hz at ± 1 dB

OUTPUT IMPEDANCE: 8 and 16 ohms

GAIN AND SENSITIVITY:

PHONO: MAG 84 dB (Output 20W at 1.1mV input)

X-TAL 54 dB (Output 20W at 36mV input)

TAPE: 86 dB (Output 20W at 0.9mV input)

MIC: 86 dB (Output 20W at 0.9mV input)

AUX: (TAPE MON) 51 dB (Output 20W at 50mV input)

TUNER: 51 dB (Output 20W at 50mV input)

RESIDUAL NOISE:

below 0.25 μ W

S/N RATIO

52 dB (at TAPE terminal)

TONE CONTROL:

Type CR

50 Hz +11 to -15 dB

10,000 Hz +12 to -13 dB

EQUALIZER:

Type NF

TAPE:

NARTB (50 μ s)

PHONO:

RIAA

ACCESSORY CIRCUITS:

PRESENCE CONTROL: Turnover at 150 Hz

LOW FILTER: 50 Hz -12.5 dB

HIGH FILTER: 10,000 Hz -13.5 dB

LOUDNESS CONTROL

TONE DEFEAT

TAPE MONITOR

HEADPHONE JACK

TAPE RECORDER PLAYBACK CONNECTION (DIN)

TERMINAL FOR CENTER-CHANNEL AMPLIFIER

LEVEL METER (FOR OUTPUT) Three ranges of 5, 10 and 25W

BLEND CONTROL

VACUUM TUBES, TRANSISTORS AND DIODES:

7189A $\times 4$, 6AN8 $\times 2$, 12AX7 $\times 3$, OA-91 germanium diode $\times 2$, 2SB-381 transistor $\times 4$, SD-1B silicon diode $\times 2$ SW-0503 silicon diode $\times 1$

TOTAL: 9 tubes and 9 diodes

POWER SUPPLY: 117V AC, 50 and 60 Hz

POWER CONSUMPTION: 150VA

DIMENSIONS: Width 15 $\frac{1}{64}$ ". Depth 12 $\frac{19}{32}$ ". Height 5 $\frac{19}{32}$ ".

WEIGHT: 30 lbs

CHARACTERISTICS

TONE CONTROL CHARACTERISTICS

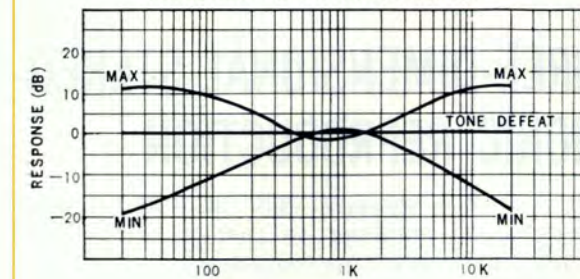

FREQUENCY RESPONSE CHARACTERISTICS

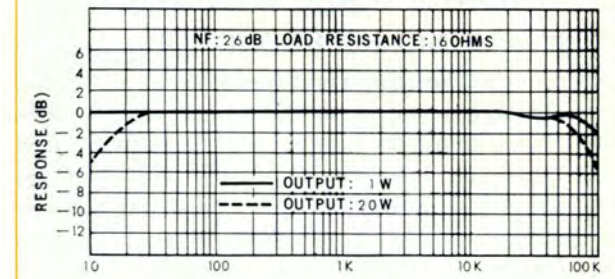

HIGH AND LOW FILTER CHARACTERISTICS

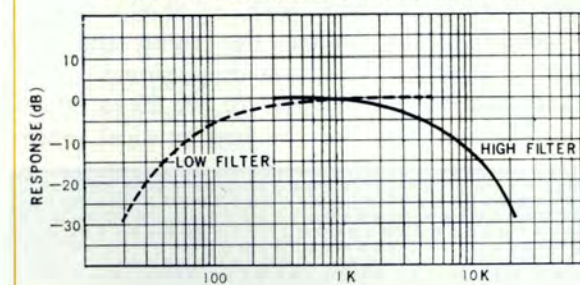

HARMONIC DISTORTION

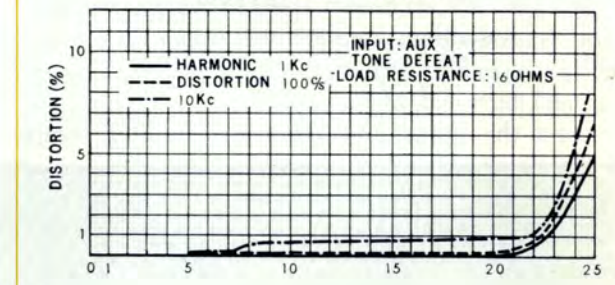

INPUT AND OUTPUT CHARACTERISTICS

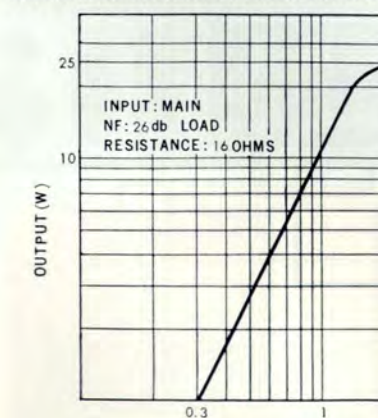

INTER MODULATION DISTORTION

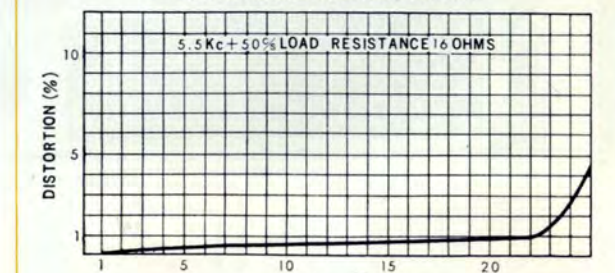

SPEAKER

STEREOPHONIC REPRODUCTION

Connect (+) of the right-hand speaker to the 8- or 16-ohm terminal of the upper R terminals on the back of the amplifier. Connect (-) of the right-hand speaker to (C) of the upper R terminals. Connect (+) of the left-hand speaker to the 8- or 16-ohm terminal of the lower L terminals on the back of the amplifier. Connect (-) of the left-hand speaker to (C) of the lower L terminals.

MONAURAL REPRODUCTION

When you use an 8-ohm speaker system for monaural reproduction, connect the upper and lower 16-ohm speaker terminals of your amplifier to the (+) terminal of the speaker. Connect the upper and lower (C) speaker termi-

nals of your amplifier to the (-) terminal of the speaker.

THREE-DIMENSIONAL STEREO-PHONIC REPRODUCTION

Your AU-70 is equipped with a terminal for a center-channel amplifier so that it can be used for three-dimensional reproduction.

To do this, connect the input terminal of a monaural amplifier (Either a main or combination amplifier can be used) to the pin-jack of the center-channel output terminal at the left of the speaker terminal board with a shielded wire. The center-channel mixes the right and left sounds to produce the three-dimensional effect. Speakers suitable for the AU-70 are 20 to 30-cm coaxial speakers and, for the best musical repro-

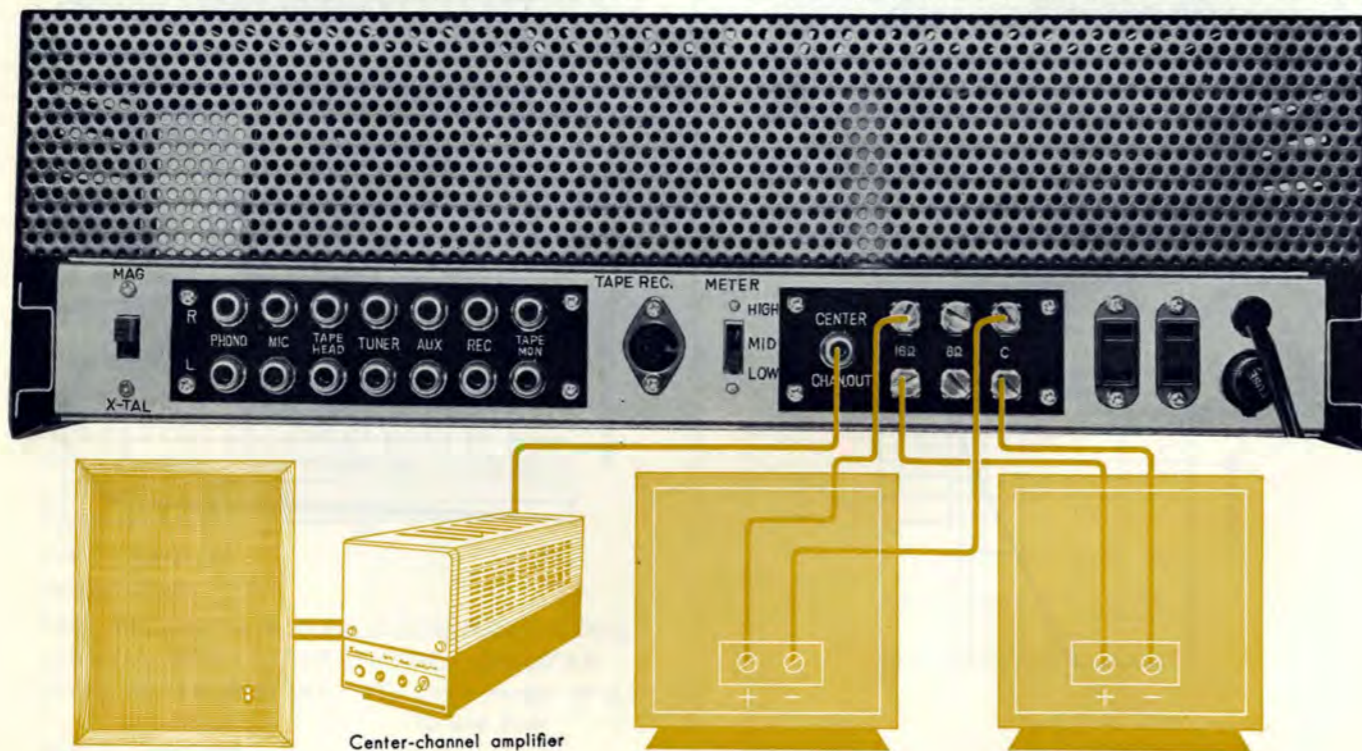

Center-channel amplifier

duction, two or three-way speaker systems which use different speakers for different frequency ranges.

In choosing the cabinet, take account of tonal quality in addition to design.

CAUTION:

If you find that the sounds from both speakers do not mix well, but leave a sort of vacuum midway between the speakers, you can conclude that the amplifier and the speakers do not match in polarity (phase). In such a case, reverse the (+) and (-) connections of either speaker.

When you use two pairs of speakers for stereophonic reproduction, make sure that the speaker output terminal connections do not cause contact between R and L and that the terminals are connected properly. If the connections are faulty, your amplifier will not work normally and may also go out of order.

RECORD PLAYER

1. Connect the output terminals to the "PHONO-R" and "PHONO-L" terminals (in the case of monaural reproduction, to either of these terminals) on the back of your amplifier with shielded wires.
2. Set the cartridge switch on the back of your amplifier to "MAG" or "X-TAL" according to the type of your cartridge.
3. Connect the power-cord plug of the player to the power plug receptacle on the back of your amplifier.

MICROPHONE

Connect the microphone to R or L of the "MIC" terminals on the back of your amplifier. When you use two microphones, connect one to R and the other to L.

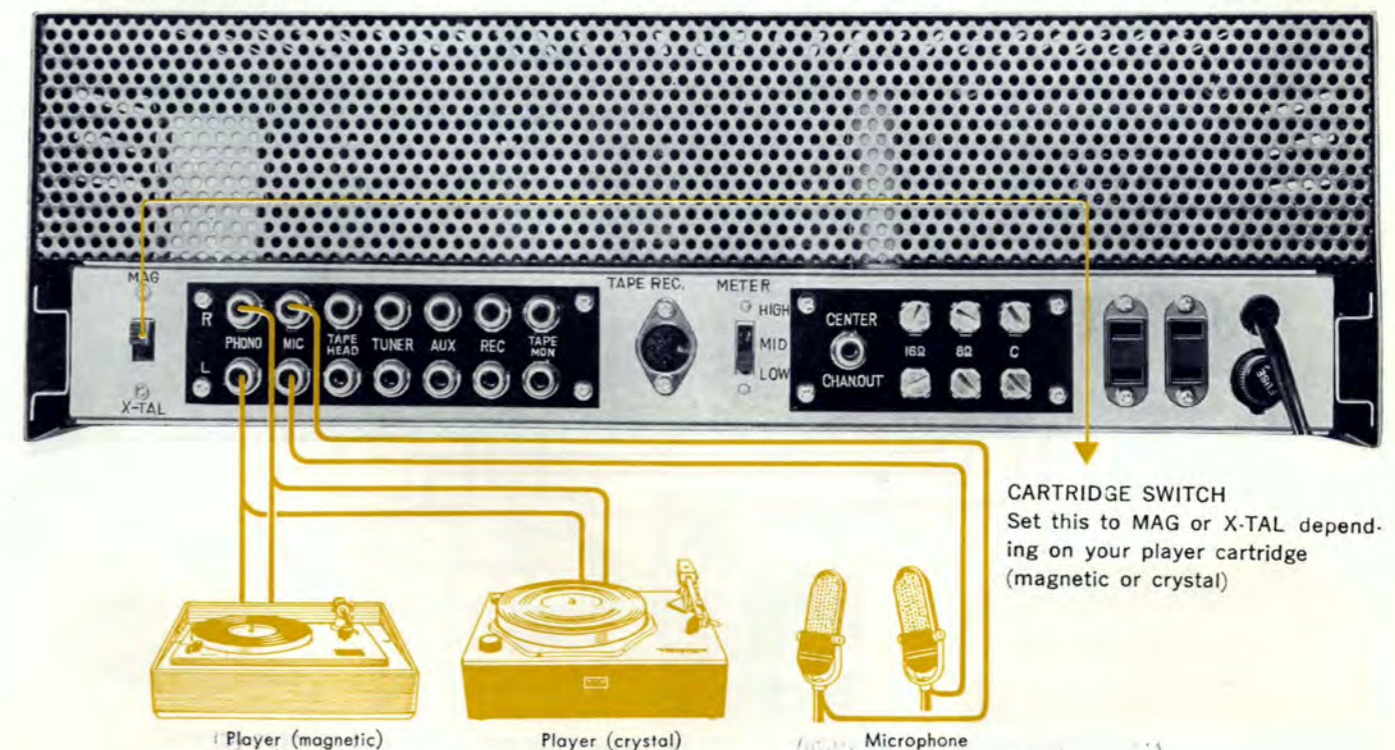

CARTRIDGE SWITCH
Set this to MAG or X-TAL depending on your player cartridge (magnetic or crystal)

CONNECTIONS

TUNER

You can listen to broadcasts easily by connecting your amplifier to a tuner and MPX adaptor.

A) STEREO TUNER

Connect tuner output to the R and L "TUNER" terminals on the back of your amplifier.

B) MONAURAL TUNER

Connect tuner output to either R or L of the "TUNER" terminals on the back of your amplifier.

C) FM MONAURAL TUNER AND FM-MPX ADAPTOR.

Connect monaural tuner output to the input terminal of the FM-MPX adaptor and connect R and L of the adaptor output terminals to R

and L, respectively, of the "AUX" terminals on the back of your amplifier.

TAPE RECORDER

1. SINGLE-CONNECTION TAPE RECORDER (DIN STANDARD SPECIFICATION):

Connect the single-connection connector to the "TAPE-REC" receptacle on the back of your amplifier.

2. PIN-JACK TAPE RECORDER

a) Recording

Connect the tape recorder input terminals to R and L (R or L in the case of monaural operation) of the "REC" terminals on the back of your amplifier with shielded wires.

b) Playback

Connect the tape recorder output terminal ("LINE") to R and L (R or L in the case of monaural operation) of the "TAPE MON" terminals on the back of your amplifier.

3. Playing tapes on the tape deck

Connect the tape deck output terminals to R and L (R or L in the case of monaural operation) of the "TAPE HEAD" terminals on the back of your amplifier.

4. Monitoring with a three-head tape recorder

a) Single-connection tape recorder

Connect the single-connection plug to the "TAPE-REC" receptacle on the back of your amplifier.

b) Pin-jack tape recorder

Connect the tape recorder input terminals to R and L (R or L in the case of monaural operation) of the "REC" terminals on the back of your amplifier. Also, connect the tape recorder output terminal "LINE" to R and L (R or L in the case of monaural operation) of the "TAPE MON" terminals on the back of your amplifier.

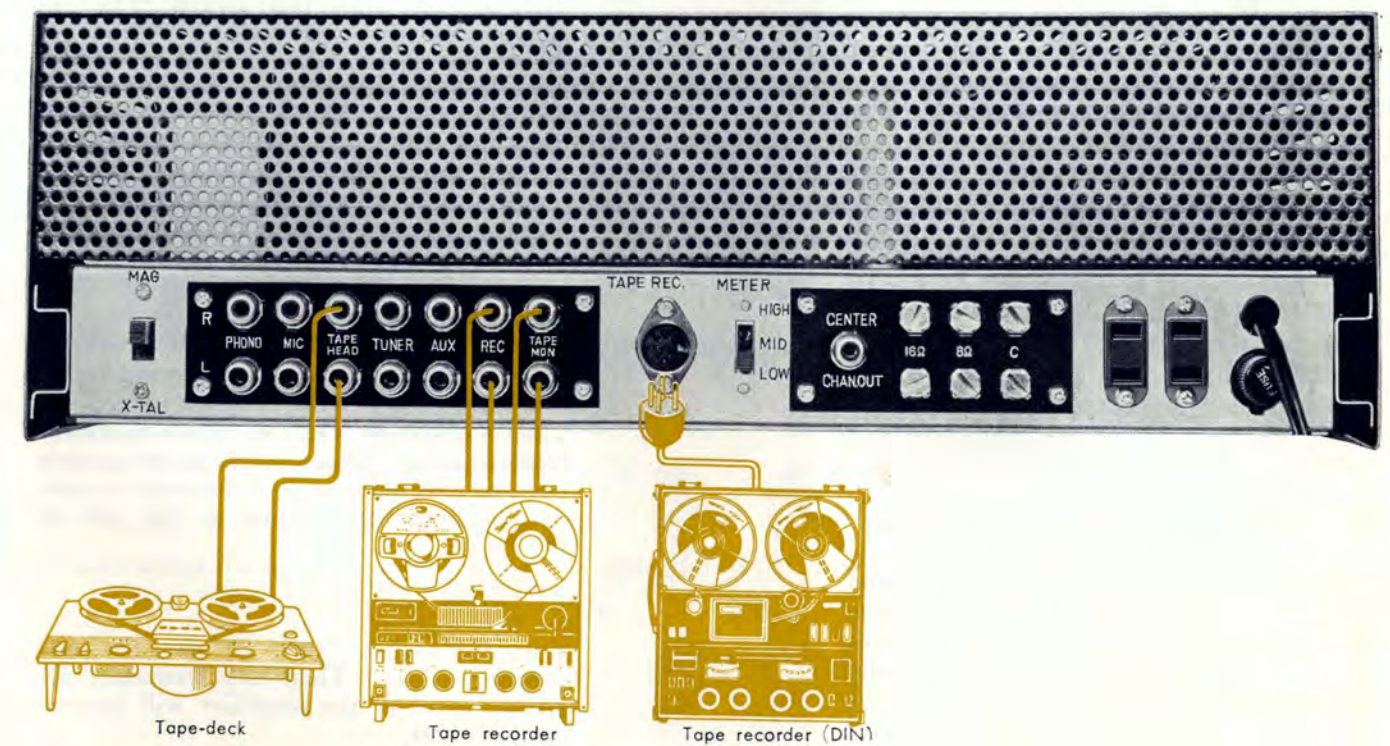
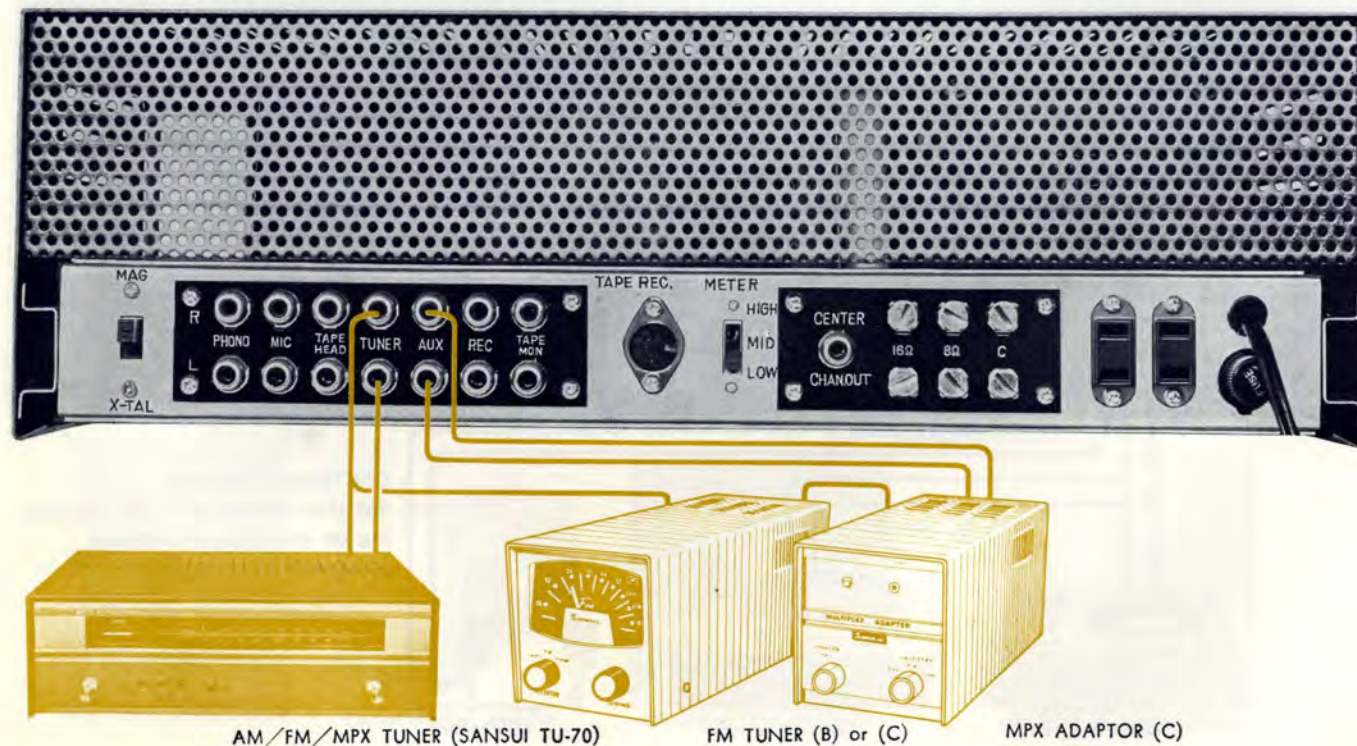

SWITCHES AND CONTROLS

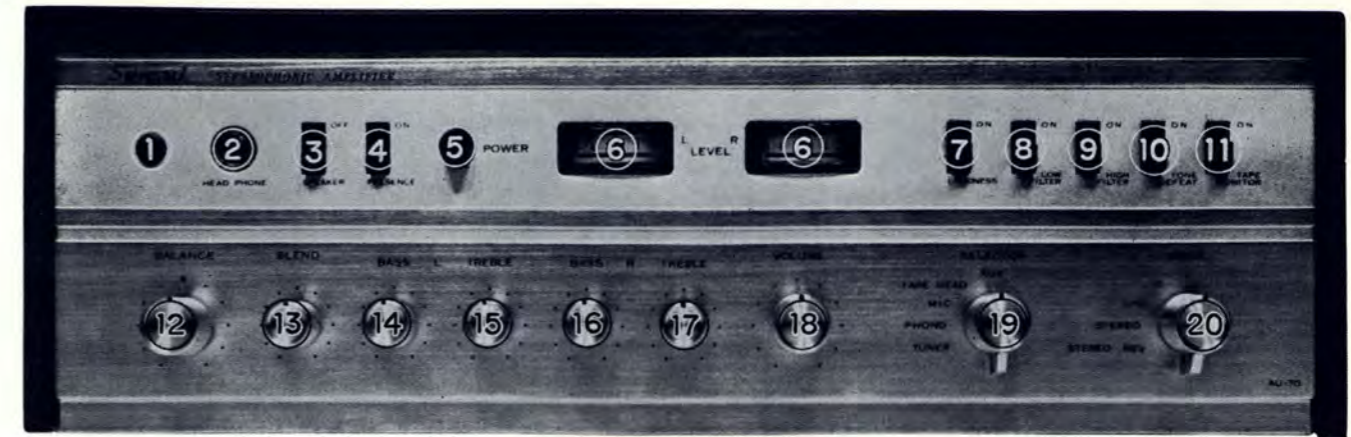

① POWER INDICATOR

This lights up when power is being supplied. It remains on while the amplifier is in operation.



② HEADPHONE JACK

When you want to avoid disturbing others or when you use the amplifier as a monitor, connect headphones to this jack. You can still enjoy stereophonic reproduction through the headphones. For this purpose, you can use any type of headphones or earphones if its plug fits into the jack. But use dynamic headphones designed for stereophonic reproduction, if possible.



③ SPEAKER (SPEAKER OFF)

When you use headphones with the headphone jack, set this switch to "OFF" to cut off sound to the speakers. This feature enables you to enjoy stereophonic reproduction without disturbing others.



④ PRESENCE

If the Tone Control alone is used for bass compensation, slightly higher frequencies are compensated at the same time. To avoid this, turn this switch "ON". This sets the turnover at 150 cps, changing speaker damping and frequency response characteristics to compensate bass. As a result, all sounds become impressive and you can enjoy clear, magnificent bass.



⑤ POWER

This switch is used for connecting and disconnecting the power supply. Push the button for power. Push it again to shut it off. The switch also activates and deactivates the power-supply plug receptacles on the back of the amplifier.



⑥ OUTPUT LEVEL METERS

The right and left meters indicate the output levels of the right and left speakers, respectively.

Since output is shown separately for each channel, the meters provide easy balance adjustment. Besides, you can watch changes in the output of each channel during operation. Each meter can be set to any of the three ranges of 5, 10 and 25 watts by means of the output-level meter switch on the back of the amplifier. Choose the appropriate range according to the output you want. When the "MODE" switch is set to R (or L), the meter for L (or R) does not work.



⑦ LOUDNESS

When sound volume is at a low level, you feel as if bass and treble are missing. In such a case, turn this switch "ON" to compensate bass and treble. This will make you feel as if you were present at an actual concert.



⑧ LOW FILTER (for eliminating low-frequency noise)

Turn this switch "ON" to reduce phono and other unpleasant low-frequency noises.



⑨ HIGH FILTER (for eliminating high-frequency noise)

Turn this switch "ON" to reduce relatively high-frequency noise, such as the scratch from records made of poor material or noise due to fluorescent lamps in the case of the tuner.



⑩ TONE DEFEAT

Turn this switch "ON" to open the tone control circuits. Then the frequency response curve of the amplifier will become perfectly flat.



⑪ TAPE MONITOR

When you make recordings with a three-head tape recorder, turn this switch "ON" to use the amplifier as a monitor. Then the sounds recorded on the tape are reproduced while you are recording. Keep this switch "ON" when you play the tape on the tape recorder. Be sure to keep the switch "OFF" otherwise.



⑫ BALANCE

This knob is used to adjust the balance of volume between the right and left speakers for the best stereophonic effect. Make the adjustment while watching the output level meters and listening to the sounds of both speakers. When the amplifier is adjusted properly, you feel as if the sound comes from a point midway between the two speakers.



⑬ BLEND

This knob permits continuous shift from stereophonic to monaural reproduction. Turn it counter-clockwise to bring reproduction closer to monaural (R+L). For complete monaural reproduction, turn it as far counter-clockwise as possible.



The sounds of the right and left speakers become separated when you turn the knob clockwise (R and L perform their respective functions). The best stereophonic effect is obtained when you turn it as far as possible.



⑭ BASS and ⑮ TREBLE for L

These control the tone of the left speaker.



⑯ BASS and ⑰ TREBLE for R

These control the tone of the right speaker.



⑱ VOLUME

This knob is used to control the volume of the tuner, records and tapes. Turn it clockwise for louder reproduction. To reduce the volume, turn counter-clockwise.



⑲ SELECTOR (input-selector)

TUNER: For receiving broadcasts through the tuner.
PHONO: For playing records.
MIC: For using a microphone.
TAPE HEAD: For playing tapes on the tape deck (directly from the tape head).
AUX: For reproducing voice input or using the MPX adaptor.



⑳ MODE (Stereophonic/monaural switch)

This switch is used to shift from stereophonic to monaural reproduction or vice versa.

STEREO: Set the switch at this position for stereo reproduction. Signals fed into A come out of A's speaker and those fed into B come out of B's speaker.

STEREO-REV: This position, too, is for stereo reproduction. But signals fed into A come out of B's speaker and those fed into B come out of A's speaker. Choose this position when the right and left are reversed in reproduction.

L+R: Signals fed into L and R are blended into one (L+R) in the amplifier before they come out separately from L and R. Signals fed into A and B become A+B in the amplifier and come out of the speakers of A and B in the form of the combined sound A+B.

R (Mono R): Signals fed into A come out of A's and B's speakers. Use this position for reproducing mono broadcasts and tapes.

L (Mono L): Signals fed into B come out of A's and B's speakers. This position is rarely used.

OPERATIONS

RECORD PLAYING

1. Set the "SELECTOR" switch at "PHONO".
2. Set the "MODE" switch at "STEREO" or "STEREO-REV" (at R or L in case of monaural operation).
3. Switch on the player, put on a record and adjust the number of revolutions as necessary before placing the pickup on the record.
4. Balance the sounds from both speakers by means of the "BALANCE" knob while watching the output level meters.
5. Adjust the amount of sound by means of the "VOLUME" knob. Other adjusting knobs and switches can be used to get the most satisfactory reproduction.

When you play a monaural record on a stereo record player, follow the same procedure as for stereo records. This will give you better results.

Catridges are either magnetic or crystal. Both can be used with the AU-70, but, if possible, use a magnetic type for the highest fidelity. If you feel that right and left are reversed when playing a stereo record, turn the "MODE" switch to "STEREO-REV". To balance the sounds from both speakers, play a monaural record in the same way as a stereo record and adjust the "BALANCE" switch in such a way that you feel that the sound comes from a point midway between the right and left speakers. In this case, you can count on the output level meters for a rough determination of the balance. Also, make sure that the "BLEND" knob is kept at the point where it cannot be turned clockwise any further.

When you supply power to the player from the power-plug receptacle on the back of your amplifier, do not forget that the player is switched off when you switch off the amplifier.

BROADCASTS

In the case of A and B above:

1. Set the "SELECTOR" switch at "TUNER".
2. Set the "MODE" switch at "STEREO" or "STEREO-REV" in the case of A and at R or L (according to the channel selected) in the case of B.
3. Tune in with the tuner.
4. Use other adjusting knobs and switches to get the most satisfactory performance.

In the case of C

1. Set the "SELECTOR" switch at "AUX".
2. Set the "MODE" switch at "STEREO" or "STEREO-REV".
3. Tune in with the tuner.
4. Prepare the FM-MPX adaptor for stereophonic reception.
5. Use other adjusting knobs and switches to get the most satisfactory performance.

When you use a tuner or FM-MPX receiver, read the instructions for them carefully. There should be no mistakes in connections and operation.

When you use our TU-70, follow the instructions for A. When you use an FM-tuner (without Multiplex) and MP-2, follow the instructions for C.

USE A MICROPHONE

You can use microphones with your AU-70 amplifier. Any high-impedance (50 kilo-ohm) crystal, dynamic or velocity microphone is acceptable.

1. Set the "SELECTOR" switch at "MIC".
2. Set the "MODE" switch at "STEREO" (when you use only one microphone for stereophonic effect)
at R (when you use only one microphone for monaural reproduction),
or at L+R (when you mix two different pro-



gram sources from two microphones.)

3. During stereophonic operation, you can use the "BLEND" knob for mixing purposes.
4. Other adjusting knobs and switches can be used for the most satisfactory reproduction. Remember that your AU-70 accepts only high-impedance microphones. You cannot get the best performance if you use too long microphone cord, which causes various problems and reduces treble.

Your amplifier has separate tone controls for right and left speakers. You will find this feature very useful when you use one microphone for music and another for voice. Furthermore, it gives added versatility to your amplifier, particularly when you record on tape what is picked up by microphones.

RECORD AND PLAY TAPES

Your AU-70 can be used with a tape recorder for recording and playback and can also play tapes on the tape deck. If you use a three-head tape recorder which has separate record and playback heads, you can make recordings while listening to a reproduction of the recordings. In other words, your amplifier can be used as a monitor which lets you know the quality of your recordings while they are being made.

RECORDING

1. Set the "SELECTOR" switch at the proper position according to the program source (broadcast or record) you are going to record.
 2. Set "MODE" switch at "STEREO" (for stereophonic recording), at R or L (for monaural recording), or at L+R (for monaural recording of a stereophonic source).
 3. Prepare the tape recorder for recording.
 4. Operate the recorder and amplifier adjusting knobs and switches properly.
- Amplifier adjusting knobs do not affect the level and tonal quality of recordings, but only control

those of the sound from the speakers. When you record a broadcast or record, you can obtain better results by connecting the tape recorder directly to your amplifier instead of picking up the sound from the speakers with microphones.

PLAYBACK

1. a) Tape deck
Set the "SELECTOR" switch at "TAPE".
b) Tape recorder
Set the "TAPE MONITOR" switch at "ON".
2. Set the tape recorder in the play position.
3. Other adjusting knobs and switches can be used for the most satisfactory reproduction.

CAUTION

When you use a Tape Recorder, keeping the "TAPE MONITOR" switch at "ON" the "MODE" switch is not operative.

If you want to use the "MODE" switch, connect the recorder output to the "AUX" pin-jacks on the back of your amplifier and the "TAPE MONITOR" switch at off.

TAPE MONITORING

To use your amplifier as a monitor for a three-head tape recorder, follow the same procedure as the one for playing tapes on a recorder. When you use a recorder, read the instruction manual carefully to avoid errors in connection and operation.

Unless you use your amplifier as a tape monitor or for playing a tape with a tape recorder, be sure to switch off the "TAPE MONITOR" switch. Connecting a tape recorder can be done by using either a single-connection connector or by pin-jacks. The single-connection plug conforms with German DIN standard specifications. It makes it easier to connect the tape recorder to your amplifier because it has a five-pin plug for both record and playback. When you use your amplifier as a tape monitor, turn on the "TAPE MONITOR" switch if you want to hear the sound you are recording.

HINTS ON USE

Fig. 1



SPEAKER POLALITY

If the phase (polarity, viz. + and -) of the right and left speakers is not correct, sounds at the center of the frequency range become weak. You will particularly sense an attenuation of bass. To make sure that speaker polarity is all right, play a monaural record on a stereo record player. If the polarity is reversed you will have the result mentioned above. In such a case, reverse the polarity of either speaker. (Connect the - lead-wire to +.) When both speakers are thus made to agree in polarity, you will feel as if the sound comes out of a single speaker placed midway between the right and left speakers.

FUSE

The amplifier does not work when the fuse is blown. In such a case, disconnect the power cord and replace the fuse on the back of the amplifier. Use a 3-ampere fuse encased in a glass tube. Never risk the danger of using fine wire or a fuse of a larger capacity as a substitute. If the fuse has burnt out because the amplifier is out of order, locate the trouble and repair it before replacing the fuse. The fuse blows if you use an AC plug receptacle larger than the specified capacity (80 VA for two).

HEAT GENERATED BY AMPLIFIER

The top of the amplifier case becomes considerably hot after many hours of continuous operation. But this should not worry you because air vents are provided on the top and back of the case. If you place something on the amplifier or put it in a closed box, or keep its front panel facing

up, it might go out of order.

CONNECTIONS

When you connect your amplifier to a tape recorder or tuner, be sure to use an adequately thick shielded wires. If you use untwisted vinyl cord like those used for lights, you will suffer from hum. Furthermore, do not use a wire longer than 2 meters (about 6.5 ft.), because the longer the connecting wire is, the greater the attenuation of treble becomes. For connection to a tuner or FM adaptor, use a wire 1 to 1.5 meters (about 3.3 to 4.8 ft.) long. When you use the amplifier for monaural reproduction, it is easier for operation to use the upper R terminal for connection. Be sure to set the "MODE" switch to the connected channel.

HUM AND HOWLING

When you play a record or tape, you may sometimes hear unpleasant humming or howling. This does not mean that your amplifier is defective. In most cases, humming or howling is a result of these causes:

If you place a record player on or near the speaker box, the vibrations of the speaker cabinet caused by the sound waves from the speaker are transmitted to the player and cause howling. To prevent this, keep the record player away from the speaker cabinet or put a thick cushion between the player and the cabinet.

A low, buzzing sound will also be produced if you do not use shielded wires for connection. If this is not the cause, examine the connections closely. Make sure that the earth and live ends are not reversed so that the motor and arm are inadequately grounded.

Fig. 2

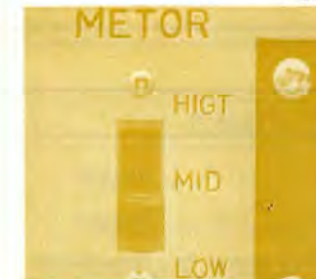
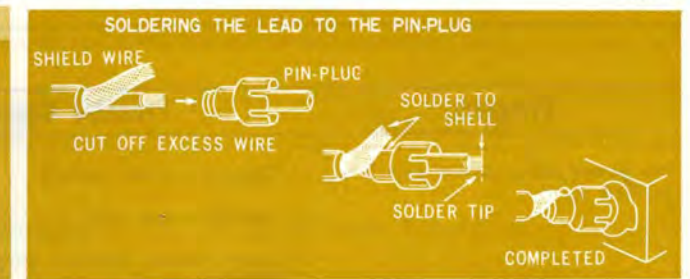

Fig. 3



CONNECT LEADWIRES PROPERLY

Connect leadwires properly to the speaker and other input and output terminals. If connections are loose or touch other parts, your amplifier will not work properly. Moreover, it may produce noise. If you use your amplifier in such a way for a long time, it may eventually break down. Finally, read the instructions for your tuner or tape recorder carefully before you connect it to your amplifier.

LEVEL METER SWITCH

This is used to select the most suitable meter sensitivity from the three ranges of 5, 10 and 25 watts. The variable sensitivity is intended to make it easier to watch needle movement.

high: up to 5 watts

medium: up to 10 watts

low: up to 25 watts (maximum output)

Choose the appropriate range according to volume level you want.

AC OUTLET

The AC outlets on the back panel are connected or disconnected by the power switch on the front panel. The total capacity is 80VA—30VA and another 50VA— Be sure to use them within the limit.

WHERE TO BE PLACED

The amplifier should be installed to the place as given below:

1. Easy to ground;
2. Floor not vibrated;

3. Not wet and dusty;
4. Not exposed to the sun;
5. Well ventilated.

SERVICE NOTE

Symptom	Probable Cause	What to Do
No power when power switch is pushed on	<ol style="list-style-type: none"> Defective power switch. Defective line cord. Loose contact between plug and socket or defective plug. Blown fuse. 	<p>Replace.</p> <p>Replace.</p> <p>Recondition or replace.</p> <p>Replace.</p> <p>If again blown after replacing, check power transformer (T₁) & path condenser (C₃₁) in power circuit for short-circuit.</p>
Power indicator is lit when power switch is pushed on, but;		
A. the unit does not work at all.	<ol style="list-style-type: none"> Defective tube. Abnormal voltage in tubes and other parts. 	<p>Check V₁~V₉ and silicon diodes.</p> <p>Check voltage in tube and other parts and replace, if necessary. If voltage is OK, check AUX input circuit and hereafter.</p>
B. PHONO and TAPE does not function.	<ol style="list-style-type: none"> Defective head amplifier (transistor section). Defective selector switch. Loose contact or short-circuit between input terminal and pin-jack. Defective record player, tape recorder, or others, connected to the unit. Defective coupling condenser. 	<p>Replace transistor head amplifier unit.</p> <p>Replace or repair S_{2a2b} and/or S_{2e}, S_{2f}</p> <p>Replace or repair.</p> <p>Replace.</p> <p>Replace C₇ and/or C₈.</p>
C. Weak sound on AUX, PHONO and TAPE.	<ol style="list-style-type: none"> Abnormal voltage in power circuit and other parts. 	Check and repair.
A. Normal voltage at every part but weak sound on AUX	<ol style="list-style-type: none"> Defective fixed resistance. Short-circuit in output transformer. Discharged capacitor. Aged tube. Defective slide switch or selector switch. 	<p>Check R₃₅~R₃₈, R₆₆~R₇₁ and Compound part CR501, CR502.</p> <p>Check T₁ and T₂.</p> <p>Check C₂₁~C₂₄, C₃₆ and C₃₇ tubular electrolytic capacitor C₂₅, C₂₆, C₄₀, C₄₁.</p> <p>Check V₁~V₉.</p> <p>Replace or repair S_{3a}, S_{3b}, S_{4a}, S_{4b}, S_{6a}~S_{6c}.</p>
B. Normal voltage at every part but weak sound on PHONO and TAPE.	<ol style="list-style-type: none"> Defective selector switch. Abnormal input circuit: loose contact between input terminal and pin-jack; defective shielded wire. Defective record player, tape recorder or others, connected to the unit. Defective coupling condenser. Discharged bypass condenser. 	<p>Replace or repair S_{2a}, S_{2b}, S_{2e}, S_{2f}, S_{3a} and S_{3b}.</p> <p>Replace or repair.</p> <p>Replace</p> <p>Check C₁, C₂, C₃, C₆, C₇, and C₈.</p> <p>Check C₃, C₄, C₉, and C₁₀.</p>

Symptom	Probable Cause	What to Do
A. Distorted sound on AUX.	<ol style="list-style-type: none"> Aged tube. Short-circuit in output transformer. Defective loudspeaker. Defective record player, adaptor or others, connected to the unit. 	<p>Check V₁~V₉.</p> <p>Check and repair T₂ and T₃</p> <p>Replace.</p> <p>Replace</p>
B. Distorted sound on PHONO and TAPE.	<ol style="list-style-type: none"> Defective record player, tape recorder or others, connected to the unit. Defective tubular electrolytic capacitor. Disconnection at fixed resistance. 	<p>Replace.</p> <p>Replace C₁ and/or C₂.</p> <p>Check R₂₇~R₃₂, R₄, R₁₃, R₁₄, R₁₅, R₁₆, R₁₇, R₁₈, R₁₉, R₂₀, R₂₁ and R₂₂.</p>
A. Hum on AUX.	<ol style="list-style-type: none"> Electrolytic capacitor discharged. Defective tube. Defective record player, adaptor or others, connected to the unit. Hum balancer not properly adjusted. Disconnected NF resistor. 	<p>Check C₃₅, C₆₆~C₇₃, C₇₆~C₇₇.</p> <p>Check V₁~V₉.</p> <p>Replace.</p> <p>Check VR₁₄ and VR₁₅.</p> <p>Check R₃₂ and R₃₃.</p>
B. Hum on PHONO and TAPE.	<ol style="list-style-type: none"> Defective shielded wire and/or wrong connection of record player, tape recorder or others. Audio system and shielded wire induced from outside. Residual hum of audio system connected to the unit. 	<p>Replace and connect correctly</p> <p>Keep proper distance between audio system and inductor.</p> <p>Replace or repair.</p>
A. Noise on AUX and TUNER.	<ol style="list-style-type: none"> Fixed resistor badly connected or touched by another part. Capacitor nearly short-circuited or touched by another part. Primary coil of output transformer nearly disconnected. Defective tube. 	<p>Check R₃₇, R₃₈, R₄₁, R₄₂, R₆₃, R₆₄, R₈₄, R₈₅, R₈₆, R₉₇, R₉₂, R₉₃, R₉₅, and R₉₆.</p> <p>Check C₅₆, C₅₇, C₆₀, C₆₁.</p> <p>Check T₂ and T₃.</p> <p>Check V₁~V₉.</p>
B. Noise on PHONO and TAPE.	<ol style="list-style-type: none"> Fixed resistor defective or nearly disconnected. Defective capacitor. Noise or bad connection of audio system connected to the unit. 	<p>Check R₇~R₃₂</p> <p>Check C₁~C₁₀</p> <p>Replace or repair</p>

PARTS LIST

Part No.	Nomenclature
R1	5K Ω 1/4 Watt \pm 10% Carbon Fixed Resistor
R2	5K Ω 1/4 Watt \pm 10% Carbon Fixed Resistor
R3	100K Ω 1/4 Watt \pm 10% Carbon Fixed Resistor
R4	100K Ω 1/4 Watt \pm 10% Carbon Fixed Resistor
R5	150K Ω 1/4 Watt \pm 10% Carbon Fixed Resistor
R6	150K Ω 1/4 Watt \pm 10% Carbon Fixed Resistor
R7	170K Ω 1/4 Watt \pm 10% Carbon Fixed Resistor
R8	170K Ω 1/4 Watt \pm 10% Noise-Less Resistor
R9	100K Ω 1/4 Watt \pm 10% Noise-Less Resistor
R10	100K Ω 1/4 Watt \pm 10% Noise-Less Resistor
R11	15K Ω 1/4 Watt \pm 10% Noise-Less Resistor
R12	15K Ω 1/4 Watt \pm 10% Noise-Less Resistor
R13	300 Ω 1/4 Watt \pm 10% Carbon Fixed Resistor
R14	300 Ω 1/4 Watt \pm 10% Carbon Fixed Resistor
R15	15K Ω 1/4 Watt \pm 10% Noise-Less Resistor
R16	15K Ω 1/4 Watt \pm 10% Noise-Less Resistor
R17	70K Ω 1/4 Watt \pm 10% Noise-Less Resistor
R18	70K Ω 1/4 Watt \pm 10% Noise-Less Resistor
R19	15K Ω 1/4 Watt \pm 10% Noise-Less Resistor
R20	15K Ω 1/4 Watt \pm 10% Noise-Less Resistor
R21	12K Ω 1/4 Watt \pm 10% Noise-Less Resistor
R22	12K Ω 1/4 Watt \pm 10% Noise-Less Resistor
R23	10 Ω 1/4 Watt \pm 10% Carbon Fixed Resistor
R24	10 Ω 1/4 Watt \pm 10% Carbon Fixed Resistor
R25	3K Ω 1/4 Watt \pm 10% Noise-Less Resistor
R26	3K Ω 1/4 Watt \pm 10% Noise-Less Resistor
R27	12K Ω 1/4 Watt \pm 10% Carbon Fixed Resistor
R28	12K Ω 1/4 Watt \pm 10% Carbon Fixed Resistor
R29	16K Ω 1/4 Watt \pm 10% Carbon Fixed Resistor
R30	16K Ω 1/4 Watt \pm 10% Carbon Fixed Resistor
R31	5K Ω 1/4 Watt \pm 10% Carbon Fixed Resistor
R32	5K Ω 1/4 Watt \pm 10% Carbon Fixed Resistor
R33	50K Ω 1/4 Watt \pm 10% Carbon Fixed Resistor
R34	50K Ω 1/4 Watt \pm 10% Carbon Fixed Resistor
R35	2.5K Ω 1/4 Watt \pm 10% Carbon Fixed Resistor
R36	2.5K Ω 1/4 Watt \pm 10% Carbon Fixed Resistor
R37	150K Ω 1/2 Watt \pm 10% Carbon Fixed Resistor
R38	150K Ω 1/2 Watt \pm 10% Carbon Fixed Resistor
R39	100K Ω 1/4 Watt \pm 10% Carbon Fixed Resistor
R40	100K Ω 1/4 Watt \pm 10% Carbon Fixed Resistor
R41	150K Ω 1/2 Watt \pm 10% Carbon Fixed Resistor
R42	150K Ω 1/2 Watt \pm 10% Carbon Fixed Resistor
R43	400K Ω 1/4 Watt \pm 10% Carbon Fixed Resistor
R44	400K Ω 1/4 Watt \pm 10% Carbon Fixed Resistor
R45	1.5K Ω 1/4 Watt \pm 10% Carbon Fixed Resistor
R46	1.5K Ω 1/4 Watt \pm 10% Carbon Fixed Resistor
R47	5M Ω 1/2 Watt \pm 10% Carbon Fixed Resistor
R48	5M Ω 1/2 Watt \pm 10% Carbon Fixed Resistor
R49	100K Ω Enclosed in CRSO2
R50	100K Ω Enclosed in CRSO2

Part No.	Nomenclature
R51	15K Ω Enclosed in CRSO2
R52	15K Ω Enclosed in CRSO2
R53	100K Ω Enclosed in CRSO2
R54	100K Ω Enclosed in CRSO2
R55	50K Ω 1/4 Watt \pm 10% Carbon Fixed Resistor
R56	50K Ω 1/4 Watt \pm 10% Carbon Fixed Resistor
R57	80K Ω 1/4 Watt \pm 10% Carbon Fixed Resistor
R58	80K Ω 1/4 Watt \pm 10% Carbon Fixed Resistor
R59	1.5K Ω 1/4 Watt \pm 10% Carbon Fixed Resistor
R60	1.5K Ω 1/4 Watt \pm 10% Carbon Fixed Resistor
R61	2M Ω 1/4 Watt \pm 10% Carbon Fixed Resistor
R62	2M Ω 1/4 Watt \pm 10% Carbon Fixed Resistor
R63	150K Ω 1/2 Watt \pm 10% Carbon Fixed Resistor
R64	150K Ω 1/2 Watt \pm 10% Carbon Fixed Resistor
R65	20K Ω 1 Watt \pm 10% Carbon Fixed Resistor
R66	2M Ω 1/4 Watt \pm 10% Carbon Fixed Resistor
R67	2M Ω 1/4 Watt \pm 10% Carbon Fixed Resistor
R68	2M Ω 1/4 Watt \pm 10% Carbon Fixed Resistor
R69	2M Ω 1/4 Watt \pm 10% Carbon Fixed Resistor
R70	1M Ω 1/4 Watt \pm 10% Carbon Fixed Resistor
R71	1M Ω 1/4 Watt \pm 10% Carbon Fixed Resistor
R72	50K Ω Enclosed in CRSO1
R73	50K Ω Enclosed in CRSO1
R74	50K Ω Enclosed in CRSO1
R75	50K Ω Enclosed in CRSO1
R76	50K Ω Enclosed in CRSO1
R77	50K Ω Enclosed in CRSO1
R78	300 Ω 1/4 Watt \pm 10% Carbon Fixed Resistor
R79	300 Ω 1/4 Watt \pm 10% Carbon Fixed Resistor
R80	1.5K Ω 1/4 Watt \pm 10% Carbon Fixed Resistor
R81	1.5K Ω 1/4 Watt \pm 10% Carbon Fixed Resistor
R82	2K Ω 1/4 Watt \pm 10% Carbon Fixed Resistor
R83	2K Ω 1/4 Watt \pm 10% Carbon Fixed Resistor
R84	600K Ω 1/2 Watt \pm 10% Carbon Fixed Resistor
R85	600K Ω 1/2 Watt \pm 10% Carbon Fixed Resistor
R86	150K Ω 1/2 Watt \pm 10% Carbon Fixed Resistor
R87	150K Ω 1/2 Watt \pm 10% Carbon Fixed Resistor
R88	12K Ω 1/4 Watt \pm 10% Carbon Fixed Resistor
R89	12K Ω 1/4 Watt \pm 10% Carbon Fixed Resistor
R90	6K Ω 1/4 Watt \pm 10% Carbon Fixed Resistor
R91	6K Ω 1/4 Watt \pm 10% Carbon Fixed Resistor
R92	30K Ω 1/2 Watt \pm 10% Carbon Fixed Resistor
R93	30K Ω 1/2 Watt \pm 10% Carbon Fixed Resistor
R94	50K Ω 1 Watt \pm 10% Carbon Fixed Resistor
R95	30K Ω 1/2 Watt \pm 10% Carbon Fixed Resistor
R96	30K Ω 1/2 Watt \pm 10% Carbon Fixed Resistor
R97	250K Ω 1/4 Watt \pm 10% Carbon Fixed Resistor
R98	250K Ω 1/4 Watt \pm 10% Carbon Fixed Resistor
R99	250K Ω 1/4 Watt \pm 10% Carbon Fixed Resistor
R100	250K Ω 1/4 Watt \pm 10% Carbon Fixed Resistor

Part No.	Nomenclature			
R101	1K Ω	1/4 Watt	$\pm 10\%$	Carbon Fixed Resistor
R102	1K Ω	1/4 Watt	$\pm 10\%$	Carbon Fixed Resistor
R103	1K Ω	1/4 Watt	$\pm 10\%$	Carbon Fixed Resistor
R104	1K Ω	1/4 Watt	$\pm 10\%$	Carbon Fixed Resistor
R105	40K Ω	1/4 Watt	$\pm 10\%$	Carbon Fixed Resistor
R106	40K Ω	1/4 Watt	$\pm 10\%$	Carbon Fixed Resistor
R107	25K Ω	1/4 Watt	$\pm 10\%$	Carbon Fixed Resistor
R108	25K Ω	1/4 Watt	$\pm 10\%$	Carbon Fixed Resistor
R109	50K Ω	1/4 Watt	$\pm 10\%$	Carbon Fixed Resistor
R110	50K Ω	1/4 Watt	$\pm 10\%$	Carbon Fixed Resistor
R111	16 Ω	10Watt	$\pm 10\%$	Wire Wound Resistor
R112	16 Ω	10Watt	$\pm 10\%$	Wire Wound Resistor
R113	30 Ω	1 Watt	$\pm 10\%$	Carbon Fixed Resistor
R114	30 Ω	1 Watt	$\pm 10\%$	Carbon Fixed Resistor
R115	2.5K Ω	1/4 Watt	$\pm 10\%$	Carbon Fixed Resistor
R116	2.5K Ω	1/4 Watt	$\pm 10\%$	Carbon Fixed Resistor
R117	5K Ω	1/4 Watt	$\pm 10\%$	Carbon Fixed Resistor
R118	150K Ω	1 Watt	$\pm 10\%$	Carbon Fixed Resistor
R119	15K Ω	1/2 Watt	$\pm 10\%$	Carbon Fixed Resistor
R120	4K Ω	2 Watt	$\pm 10\%$	Carbon Fixed Resistor
R121	2K Ω	10Watt	$\pm 10\%$	Wire Wound Resistor
R122	12K Ω	20Watt	$\pm 10\%$	Wire Wound Resistor
R123	2k Ω	1/4 Watt	$\pm 10\%$	Carbon Fixed Resistor
R124	500 Ω	1/4 Watt	$\pm 10\%$	Carbon Fixed Resistor
R125	7K Ω	1/4 Watt	$\pm 10\%$	Carbon Fixed Resistor
R126	7K Ω	1/4 Watt	$\pm 10\%$	Carbon Fixed Resistor
R127	7K Ω	1/4 Watt	$\pm 10\%$	Carbon Fixed Resistor
R128	7K Ω	1/4 Watt	$\pm 10\%$	Carbon Fixed Resistor
R129	6K Ω	1/4 Watt	$\pm 10\%$	Carbon Fixed Resistor
R130	2K Ω	1/4 Watt	$\pm 10\%$	Carbon Fixed Resistor
C1	30 μ F	10WV		Electrolytic tubular
C2	30 μ F	10WV		Electrolytic tubular
C3	30 μ F	10WV		Electrolytic tubular
C4	30 μ F	10WV		Electrolytic tubular
C5	30 μ F	12WV		Electrolytic tubular
C6	30 μ F	12WV		Electrolytic tubular
C7	10 μ F	10WV		Electrolytic tubular
C8	10 μ F	10WV		Electrolytic tubular
C9	30 μ F	10WV		Electrolytic tubular
C10	30 μ F	10WV		Electrolytic tubular
C11	0.06 μ F	50WV	$\pm 10\%$	mylar tubular
C12	0.06 μ F	50WV	$\pm 10\%$	mylar tubular
C13	0.025 μ F	50WV	$\pm 10\%$	mylar tubular
C14	0.025 μ F	50WV	$\pm 10\%$	mylar tubular
C15	0.01 μ F	50WV	$\pm 10\%$	mylar tubular
C16	0.01 μ F	50WV	$\pm 10\%$	mylar tubular
C17	150pF	500WV	$\pm 10\%$	mica tubular
C18	150pF	500WV	$\pm 10\%$	mica tubular
C19	0.01 μ F	50WV	$\pm 10\%$	mylar tubular

Part No.	Nomenclature			
C20	0.01 μ F	50WV	$\pm 10\%$	mylar tubular
C21	0.003 μ F	400WV	$\pm 10\%$	oil tubular
C22	0.003 μ F	400WV	$\pm 10\%$	oil tubular
C23	0.1 μ F	250WV	$\pm 10\%$	MP tubular
C24	0.1 μ F	250WV	$\pm 10\%$	MP tubular
C25	4 μ F	20WV		Electrolytic tubular
C26	4 μ F	20WV		Electrolytic tubular
C27	0.001 μ F	400WV	$\pm 10\%$	oil tubular
C28	0.001 μ F	400WV	$\pm 10\%$	oil tubular
C29	150pF	Enclosed	in CRSO2	
C30	150pF	Enclosed	in CRSO2	
C31	0.003 μ F	Enclosed	in CRSO2	
C32	0.003 μ F	Enclosed	in CRSO2	
C33	0.03 μ F	Enclosed	in CRSO2	
C34	0.03 μ F	Enclosed	in CRSO2	
C35	20 μ F	300WV		Electrolytic tubular
C36	0.1 μ F	250WV		MP tubular
C37	0.1 μ F	250WV		MP tubular
C38	30 μ F	6WV		Electrolytic tubular
C39	30 μ F	6WV		Electrolytic tubular
C40	4 μ F	20WV		Electrolytic tubular
C41	4 μ F	20WV		Electrolytic tubular
C42	0.005 μ F	400WV		oil tubular
C43	0.005 μ F	400WV		oil tubular
C44	0.005 μ F	400WV		oil tubular
C45	0.005 μ F	400WV		oil tubular
C46	0.01 μ F	400WV	$\pm 10\%$	oil tubular
C47	0.01 μ F	400WV	$\pm 10\%$	oil tubular
C48	300pF	Enclosed	in CRSO1	
C49	300pF	Enclosed	in CRSO1	
C50	200pF	Enclosed	in CRSO1	
C51	200pF	Enclosed	in CRSO1	
C52	200pF	Enclosed	in CRSO1	
C53	200pF	Enclosed	in CRSO1	
C54	30 μ F	6WV		Electrolytic tubular
C55	30 μ F	6WV		Electrolytic tubular
C56	0.2 μ F	250WV	$\pm 10\%$	MP tubular
C57	0.2 μ F	250WV	$\pm 10\%$	MP tubular
C58	0.5 μ F	250WV	$\pm 10\%$	MP tubular
C59	0.5 μ F	250WV	$\pm 10\%$	MP tubular
C60	80pF	500WV	$\pm 10\%$	mica tubular
C61	80pF	500WV	$\pm 10\%$	mica tubular
C62	0.3 μ F	250WV	$\pm 10\%$	MP tubular
C63	0.3 μ F	250WV	$\pm 10\%$	MP tubular
C64	0.3 μ F	250WV	$\pm 10\%$	MP tubular
C65	0.3 μ F	250WV	$\pm 10\%$	MP tubular
C66	20 μ F	300WV		Electrolytic lug terminal
C67	20 μ F	300WV		Electrolytic lug terminal
C68	20 μ F	300WV		Electrolytic lug terminal
C69	20 μ F	300WV		Electrolytic lug terminal

Part No.	Nomenclature			
C70	40 μ F	500WV		Electrolytic lug terminal
C71	40 μ F	500WV		Electrolytic lug terminal
C72	200 μ F	300WV		Electrolytic lug terminal
C73	200 μ F	300WV		Electrolytic lug terminal
C74	0.005 μ F	600WV	$\pm 10\%$	oil tubular
C75	0.005 μ F	600WV	$\pm 10\%$	oil tubular
C76	50 μ F	50WV		Electrolytic tubular
C77	50 μ F	25WV		Electrolytic tubular
C78	200 μ F	25WV		Electrolytic tubular
C79	200 μ F	25WV		Electrolytic tubular
C80	0.005 μ F	500WV	$\pm 100\%$	Ceramic tubular
C81	0.05 μ F	400WV	$\pm 10\%$	oil tubular
VR1 VR2	500K Ω	(A) Variable Resistor	24 ϕ type	Loudness tap 120K Ω (Volume control)
VR3~VR6	1M Ω	(N) Variable Resistor	24 ϕ type	(Tone control)
VR7 VR8	500K Ω	(A.C) Variable Resistor	24 ϕ type	(Balance control)
VR10~13	50K Ω	(B) Variable Resistor	driver type	
VR14 VR15	100 Ω	Hum Balancer	driver type	
V1~V3b	12AX7	Pre amplifier		
V4a~V5b	6AN8	Phase splitter		
V6~V9	7189A	Power amplifier		
TR1~TR4	25B-381	Head amplifier		
T1		Power transformer		
T2, T3		Output transformer		
SD-1B	Si diode	AC (RMS) 280V ID 500mA		-60 $^{\circ}$ C~+100 $^{\circ}$ C
SW-0503	Si diode	AC (RMS) 90V ID 500mA		-55 $^{\circ}$ C~+100 $^{\circ}$ C
S1(a~b)		Cartridge switch		
S2(a~f)		Input Selector switch		
S3(a~c)		Mode switch		
S4(a~b)		Tape monitor switch		
S5(a~b)		Loudness switch		
S6(a~d)		Tone defeat switch		
S7(a~d)		Low filter switch		
S8(a~b)		High filter switch		
S9(a~b)		Presence switch		
S10(a~b)		Speaker switch		
S11(a~b)		Level meter control switch		
S12		Power switch		
S13a, 13b		Level meter pilot lamp switch		
S14a, 14b		Level meter switch		
CO1~2		AC outlet		
OA-91	Ge. diode	VD=90V ID=25mA		-55 $^{\circ}$ ~75 $^{\circ}$ C

SCHEMATIC DIAGRAM

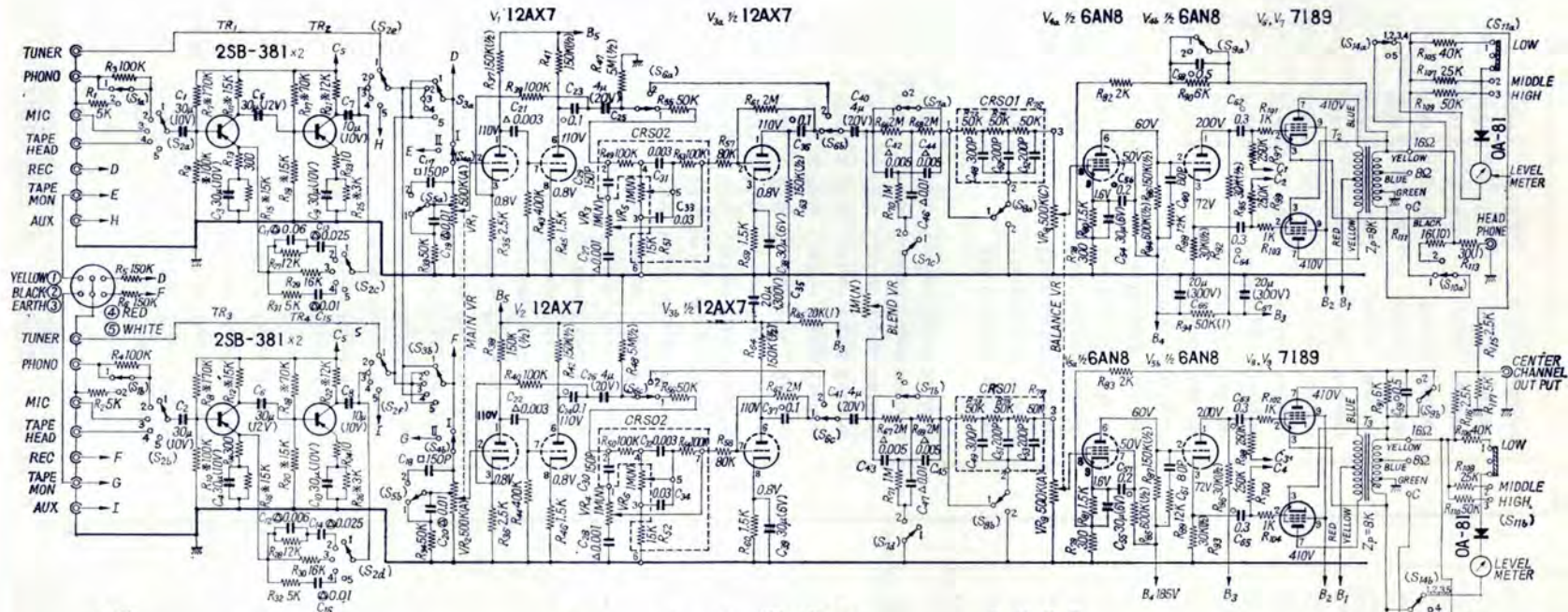

- △ OIL
 - MICA
 - MP
 - MYLAR
 - * NOISE LESS
 - CERAMIC
- S₁ (a-b)**
 1 MAG
 2 Xtal
- S₂ (a-f) INPUT SELECTOR**
 1 TUNER
 2 PHONO
 3 MIC
 4 TAPE
 5 AUX
- S₃ (a-b)**
 1 OFF
 2 ON TUNE DEFEAT
- S₄ (a-b)**
 1 OFF
 2 ON LOW FILTER
- S₅ (a-c) MODE SELECTOR**
 1 REVERSE
 2 NORMAL
 3 MIX (R+L)
 4 CHAN R
 5 CHAN L
- S₆ (a-b)**
 1 OFF
 2 ON LOUDNESS
- S₇ (a-d)**
 1 OFF
 2 ON HIGH FILTER
- S₈ (a-b)**
 1 OFF
 2 ON PRESENCE
- S₉ (a-b)**
 1 OFF
 2 ON AC
- S₁₀ (a-b)**
 1 ON
 2 OFF SPEAKER
- S₁₁ (a-b)**
 1 LEVEL LOW
 2 LEVEL MIDDLE
 3 LEVEL HIGH
- S₁₂**
 1 OFF
 2 ON AC
- S_{13a} PILOT LAMP**
 1,2,3,4 OFF
 5 ON
- S_{13b} PILOT LAMP**
 1,2,3,5 OFF
 4 ON

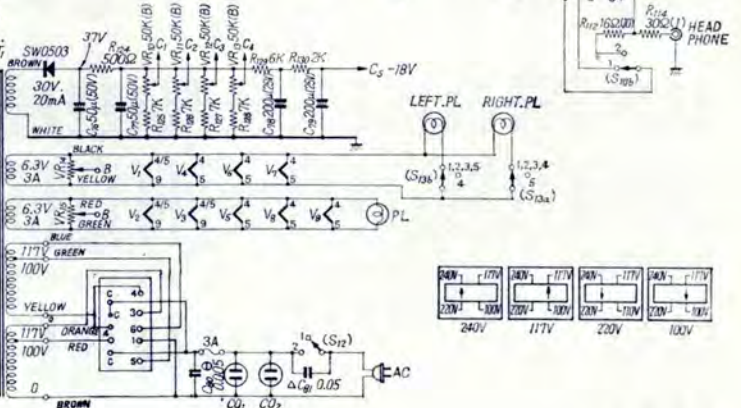
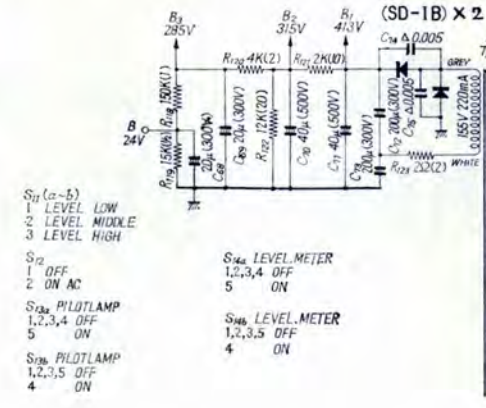

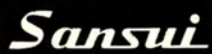
The Sansui logo consists of the word "Sansui" in a stylized, italicized serif font, set against a solid black rectangular background.

SANSUI ELECTRIC COMPANY LIMITED

Head Office; 14-1, 2-chome, Izumi, Suginami-ku, Tokyo, Japan. TEL. 323-1111

Printed in Japan (O1200M6)