

INSPIRON™

SETUP GUIDE





YOURS IS HERE

INSPIRON™

SETUP GUIDE

Model PP29L

Notes, Notices, and Cautions

-  **NOTE:** A NOTE indicates important information that helps you make better use of your computer.
-  **NOTICE:** A NOTICE indicates either potential damage to hardware or loss of data and tells you how to avoid the problem.
-  **CAUTION:** A CAUTION indicates a potential for property damage, personal injury, or death.

Information in this document is subject to change without notice.

© 2008 Dell Inc. All rights reserved.

Reproduction of these materials in any manner whatsoever without the written permission of Dell Inc. is strictly forbidden.

Trademarks used in this text: *Dell*, the *DELL* logo, *Inspiron*, *YOURS IS HERE*, *WiFi-Catcher*, and *DellConnect* are trademarks of Dell Inc.; *Intel*, *Pentium*, and *Celeron* are registered trademarks and *Core* is a trademark of Intel Corporation in the U.S. and other countries; *Microsoft*, *Windows*, *Windows Vista start button logo*, and *Windows Vista* are either trademarks or registered trademarks of Microsoft Corporation in the United States and/or other countries.; *Bluetooth* is a registered trademark owned by Bluetooth SIG, Inc. and is used by Dell under license.

Other trademarks and trade names may be used in this document to refer to either the entities claiming the marks and names or their products. Dell Inc. disclaims any proprietary interest in trademarks and trade names other than its own.

This product incorporates copyright protection technology that is protected by method claims of certain U.S. patents and other intellectual property rights owned by Macrovision Corporation and other rights owners. Use of this copyright protection technology must be authorized by Macrovision Corporation, and is intended for home and other limited viewing uses only unless otherwise authorized by Macrovision Corporation. Reverse engineering or disassembly is prohibited.

October 2008

P/N Y465H

Rev. A01

Contents

Setting Up Your Inspiron Laptop	5	Display Features	21
Before Setting Up Your Computer	5	Removing and Replacing the Battery	22
Connect the AC Adapter	6	Software Features	23
Check the Wireless Switch	6	Solving Problems	26
Connect the Network Cable (optional)	7	Network Problems	26
Press the Power Button	7	Power Problems	28
Microsoft® Windows® Setup	8	Memory Problems	29
Connect to the Internet (Optional)	8	Lockups and Software Problems	30
Using Your Inspiron Laptop	12	Dell Support Center	33
Device Status Lights	12	System Messages	33
Right Side Features	14	Using Support Tools	33
Left Side Features	16	Hardware Troubleshooter	35
Front Side Features	18	Dell Diagnostics	36
Computer Base and Keyboard Features	19	System Restore	38
Media Controls	20		

Contents

Restoring Your Operating System	39	Finding More Information and Resources	52
Windows XP: Using Dell™ PC Restore	40	Basic Specifications	54
Windows Vista: Dell Factory Image Restore	42	Index	64
Operating System Reinstallation	43		
Technical Support and Customer Service	45		
Getting Help	46		
DellConnect™	46		
Online Services	46		
AutoTech Service.	47		
Product Information.	48		
Returning Items for Repair Under Warranty or for Credit.	48		
Before You Call.	49		
Contacting Dell.	50		

Setting Up Your Inspiron Laptop

This section provides information about setting up your Inspiron 1525/1526 laptop and connecting peripherals.

Before Setting Up Your Computer

When positioning your computer, ensure that you allow easy access to a power source, adequate ventilation, and a level surface to place your computer.

Restricting airflow around your Inspiron computer may cause it to overheat. To prevent overheating ensure that you leave at least 10.2 cm (4 in) at the back of the computer and a minimum of 5.1 cm (2 in) on all other sides. You should never put your computer in an enclosed space, such as a cabinet or drawer when it is powered on.

 **NOTICE:** Placing or stacking heavy or sharp objects on the computer may result in permanent damage to the computer.

Connect the AC Adapter

Connect the AC adapter to the computer and then plug it into a wall outlet or surge protector.

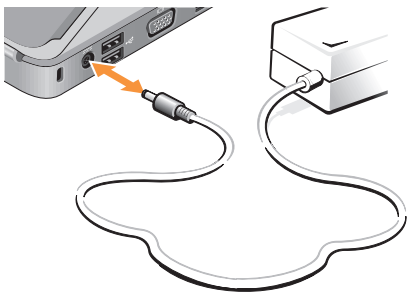

CAUTION: The AC adapter works with electrical outlets worldwide. However, power connectors and power strips vary among countries. Using an incompatible cable or improperly connecting the cable to a power strip or electrical outlet may cause fire or equipment damage.

Check the Wireless Switch

If you plan to use wireless connections, make sure the wireless switch is in the "On" position.



Using The Wireless Switch

To turn on the wireless switch, slide it from the rear to the front of the computer until it clicks into place.

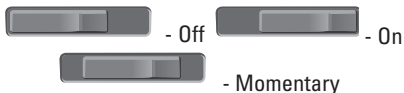

Connect the Network Cable (optional)

If you plan to use a wired network connection, plug in the network cable.

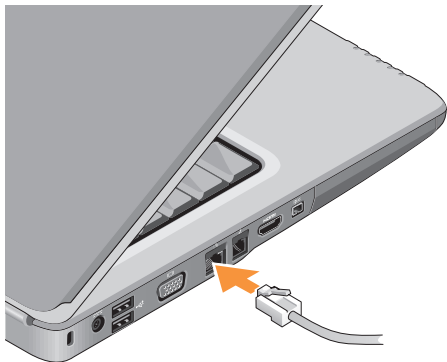

Press the Power Button



Microsoft® Windows® Setup

Your Dell computer is preconfigured with Microsoft Windows operating system. To set up Windows for the first time, follow the instructions on the screen. These steps are mandatory and may take up to 15 minutes to complete. The screens will take you through several procedures including accepting license agreements, setting preferences and setting up an Internet connection.

- ➔ **NOTICE:** Do not interrupt the operating system's setup process. Doing so may render your computer unusable.

Connect to the Internet (Optional)

- 📌 **NOTE:** ISPs and ISP offerings vary by country.

To connect to the Internet, you need an external modem or network connection and an Internet service provider (ISP).

Setting Up a Wired Internet Connection

If you are using a dial-up connection, connect the telephone line to the external USB modem (optional) and to the telephone wall jack before you set up your Internet connection. If you are using a DSL or cable/satellite modem connection, contact your ISP or cellular telephone service for setup instructions.

Setting Up a Wireless Connection

Before you can use your wireless Internet connection, you need to connect to your wireless router. To set up your connection to a wireless router:

1. Save and close any open files, and exit any open programs.
2. Click **Start**  → **Connect To**.
3. Follow the instructions on the screen to complete the setup.

Setting Up Your Internet Connection

To set up an Internet connection with a provided ISP desktop shortcut:

1. Save and close any open files, and exit any open programs.
2. Double-click the ISP icon on the Microsoft® Windows® desktop.
3. Follow the instructions on the screen to complete the setup.

If you do not have an ISP icon on your desktop or if you want to set up an Internet connection with a different ISP, perform the steps in the following section.

 **NOTE:** If you cannot connect to the Internet but have successfully connected in the past, the ISP might have a service outage. Contact your ISP to check the service status, or try connecting again later.

 **NOTE:** Have your ISP information ready. If you do not have an ISP, the Connect to the Internet wizard can help you get one.

Windows Vista

1. Save and close any open files, and exit any open programs.
2. Click **Start**  → **Control Panel**.
3. Under **Network and Internet**, click **Connect to the Internet**.

The **Connect to the Internet** window appears.

Setting Up Your Inspiron Laptop

4. Click either **Broadband (PPPoE)** or **Dial-up**, depending on how you want to connect:
 - a. Choose **Broadband** if you will use a DSL, satellite modem, cable TV modem, or Bluetooth® wireless technology connection.
 - b. Chose **Dial-up** if you will use an optional USB dial-up modem or ISDN.
-  **NOTE:** If you do not know which type of connection to select, click **Help me choose** or contact your ISP.
5. Follow the instructions on the screen and use the setup information provided by your ISP to complete the setup.

Windows XP

1. Save and close any open files, and exit any open programs.
2. Click **Start** → Internet Explorer.
The **New Connection Wizard** appears.

3. Click **Connect** to the Internet.
4. In the next window, click the appropriate option:
 - If you do not have an ISP and want to select one, click Choose from a list of Internet service providers (ISPs).
 - If you have already obtained setup information from your ISP but you did not receive a setup CD, click Set up my connection manually.
 - If you have a CD, click Use the CD I got from an ISP.
5. Click **Next**.

If you selected Set up my connection manually, continue to step 6. Otherwise, follow the instructions on the screen to complete the setup.

-  **NOTE:** If you do not know which type of connection to select, contact your ISP.

6. Click the appropriate option under How do you want to connect to the Internet?, and then click **Next**.
7. Use the setup information provided by your ISP to complete the setup.





Using Your Inspiron Laptop

Your Inspiron 1525/1526 has several indicators, buttons, and features that provide information at-a-glance and time-saving shortcuts for common tasks.

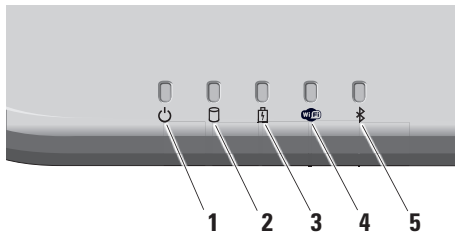
Device Status Lights

The device status lights located at the front left of the computer provide information for wireless communication and keyboard input options.



- 1  **Power light** – Turns on when you turn on the computer, and blinks when the computer is in a power management mode.
- 2  **Hard drive activity light** – Turns on when the computer reads or writes data. A flashing light indicates hard drive activity.
 **NOTE:** To avoid loss of data, never turn off the computer while the hard drive activity light is flashing..
- 3  **Battery status light** – Turns on steadily or blinks to indicate battery charge status.

- 4  **WiFi status light** – Turns on when wireless networking is enabled.

Use the wireless switch located at the, right side of the computer to quickly turn all wireless communication on and off.

Using The Wireless Switch

To turn on the wireless switch, slide it away from the front of the computer until it clicks into place.

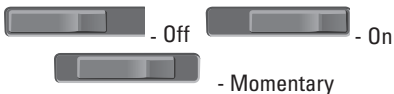



- 5  **Bluetooth® status light** – Turns on when a card with Bluetooth wireless technology is enabled.

 **NOTE:** The card with Bluetooth wireless technology is an optional feature.

To turn off Bluetooth wireless, right-click the bluetooth icon in the notification area of your desktop, and click **Disable Bluetooth Radio** or use the wireless switch.

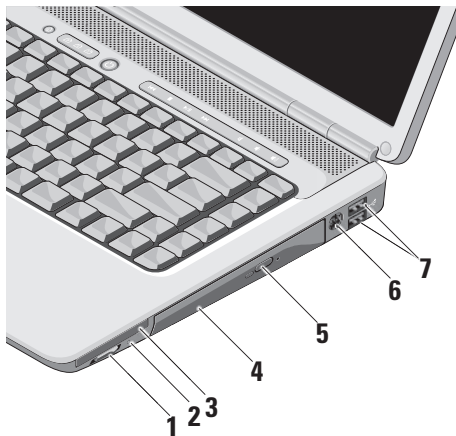
Right Side Features



- 1  **Wireless On/Off switch** – Use this switch to rapidly turn all wireless devices off or on such as WLAN cards and internal cards with Bluetooth wireless technology.

The wireless switch may be in the Off position when your computer is shipped to you. To turn the switch On, slide the switch away from the front of the computer until it clicks into place.



-  **NOTE:** This switch can be deactivated through Dell QuickSet or the BIOS (system setup program).

Off - Disables wireless devices

On - Enables wireless devices

momentary - Scans for WLAN networks

2 Wi-Fi Catcher™ light -

The light operates as follows:

Flashing blue: Searching for networks

Solid blue: Strong network found

Solid yellow: Weak network found

Off: No signal found

3  **ExpressCard slot** – Supports one ExpressCard. The computer ships with a plastic *blank* installed in the slot.

4 Optical Drive – Plays or burns only standard-size and shape (12 cm) CDs, and DVDs. Ensure that the side with print or writing is facing upward when inserting discs.

5 Eject Button – Press the eject button to open the optical drive.

6 S-video TV-out connector – Connects your computer to a TV. Also connects digital audio-capable devices using the TV/digital audio adapter cable.

7  **USB 2.0 connectors (2)** – Connects a USB device, such as a mouse, keyboard, printer, external drive, or MP3 player.

Left Side Features

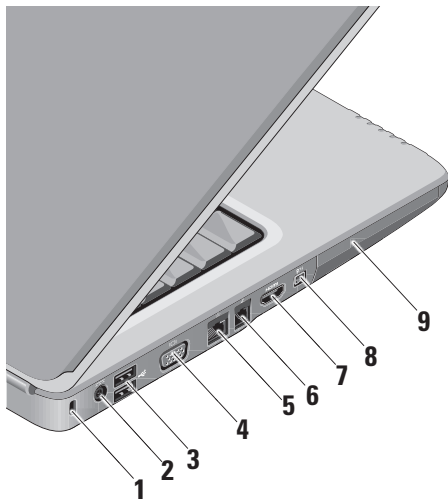

- 1 **Security cable slot** – Used to attach a commercially available antitheft device to the computer.



 **NOTE:** Before you buy an antitheft device, ensure that it works with the security cable slot on your computer.

- 2  **AC adapter connector** – Connects to the AC adapter to power the computer and charge the battery when the computer is not in use.

- 3  **USB connectors (2)**– Connects to a USB device, such as a mouse, keyboard, printer, external drive, or MP3 player.



- 4  **VGA connector** – Connects to a monitor or projector.

- 5  **Network connector** – If you are using a cabled network signal, this connects your computer to a network or broadband device.

- 6  **Modem connector** – Connect the telephone line to the modem connector. For information on using the modem, see the online modem documentation supplied with your computer.
- 7  **HDMI connector** – HDMI (High-Definition Multimedia Interface) connector carries an uncompressed all digital signal to produce hi-definition video and audio.
- 8  **IEEE 1394 connector** – Connects to high-speed serial multimedia devices, such as digital video cameras.
- 9 **Hard Drive** – Stores software and data.

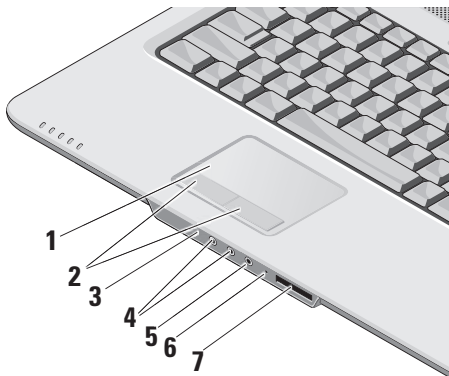
Front Side Features



- 1 Touch pad** – Provides the functionality of a mouse to move the cursor, drag or move selected items, and left-click by tapping the surface.
- 2 Touch pad buttons** – Provide left- and right-click functions those on like a mouse
- 3 Consumer IR** – Infrared sensor for using the Dell Travel Remote.
- 4  Audio Out/ Headphone connectors (2)**
– Connects one pair of headphones, or sends audio to a powered speaker or sound system.
- 5  Audio In/ Microphone connector** – Connects to a microphone or input signal for use with audio programs.
- 6 Analog Microphone** – If you do not have the optional built-in camera with dual microphones, this single microphone is used for conferencing and chat.

7

SD/MMC - MS/Pro - xD

8-in-1 Media card reader – Provides a fast and convenient way to view and share digital photos, music, videos, and documents stored on the following digital memory cards:

- Secure digital (SD) memory card
- SDHC (Secure Digital High Capacity) card
- Multi Media Card (MMC)
- Memory Stick
- Memory Stick PRO
- xD-Picture Card (type - M and type - H)

Computer Base and Keyboard Features

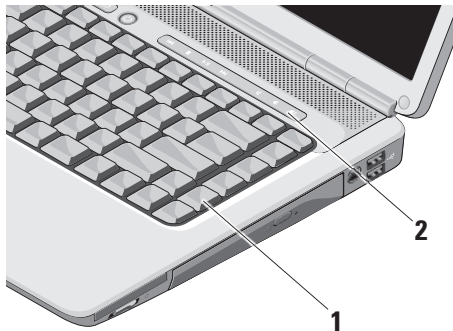

- 1 Keyboard** – The settings for this keyboard can be personalized by using Dell QuickSet. For more information, see the *Dell Technology Guide*.
- 2 Media Controls** – Controls CD, DVD, and media playback.

Media Controls

To use the media controls, press the button and then release.



 Play the previous track or chapter

 Stop

 Play or pause

 Play the next track or chapter

 Mute the sound

 Turn down the volume

 Turn up the volume

Display Features

The display panel holds an optional camera and accompanying dual microphones.

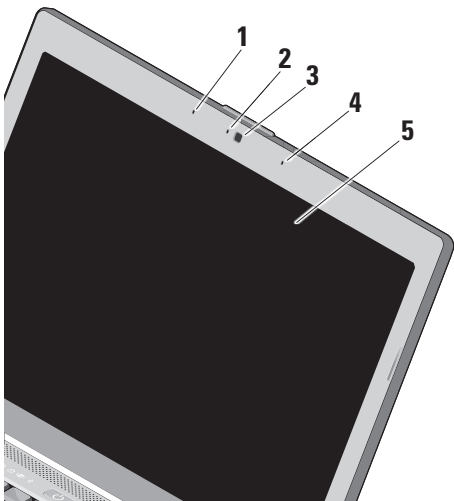

- 1 Left digital array microphone** – Combines with the right digital array microphone to provide high quality sound for video chatting and voice recording.
- 2 Camera activity indicator (optional)** – Light that indicates when the camera is on an off. Based on selections you made when purchasing your computer, your computer may not include a camera.
- 3 Camera (optional)** – Built-in camera for video capture, conferencing, and chat. Based the on selections you made when purchasing your computer, your computer may not include a camera.
- 4 Right digital array microphone** – Combines with the left digital array microphone to provide high quality sound for video chatting and voice recording.
- 5 Display** – Your display can vary based on selections you made when purchasing your computer. For more information about displays, see the *Dell Technology Guide*.

Removing and Replacing the Battery

CAUTION: Using an incompatible battery may increase the risk of fire or explosion. This computer should only use a battery purchased from Dell. Do not use batteries from other computers.

CAUTION: Before removing the battery, shut down the computer, and remove external cables (including the AC adapter).

To remove the battery:

1. Shut down the computer and turn it over.
2. Slide the battery release latch until it clicks into place.
3. Slide the battery out.

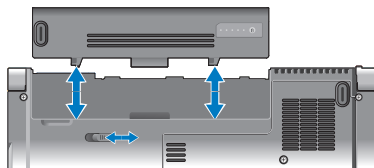

To replace the battery, slide it into the bay until it clicks into place.

Software Features

 **NOTE:** For more information about the features described in this section, see the *Dell Technology Guide* on your hard drive or on the Dell Support website at support.dell.com.

Productivity and Communication

You can use your computer to create presentations, brochures, greeting cards, fliers, and spreadsheets. You can also edit and view digital photographs and images. Check your purchase order for software installed on your computer.

After connecting to the Internet, you can access websites, setup an e-mail account, upload and download files, and so on.

Entertainment and Multimedia

You can use your computer to watch videos, play games, create your own CDs, listen to music and internet radio stations. Your optical

disc drive may support multiple disc media formats including CDs and DVDs.

You can download or copy pictures and video files from portable devices, such as digital cameras and cell phones. Optional software applications enable you to organize and create music and video files that can be recorded to disc, saved on portable products such as MP3 players and handheld entertainment devices, or played and viewed directly on connected TVs, projectors, and home theater equipment.

Customizing the Desktop in Windows Vista

You can customize your desktop to change the appearance, resolution, wallpaper, screensaver, and so on by accessing the **Personalize appearance and sounds** window.

To access the display properties window:

1. Right-click an open area of the desktop.
2. Click **Personalize**, to open the **Personalize appearance and sounds** window and learn more about your customization options.

Customizing the Desktop in Windows XP

You can customize your desktop to change the appearance, resolution, wallpaper, screensaver, and so on by accessing the **Display Properties** window.

To access the display properties window:

1. Right-click an open area of the desktop.
2. Click **Properties**, to open the **Display Properties** window and learn more about your customization options.

Customizing Your Energy Settings

You can use the power options in your operating system to configure the power settings on your computer. Microsoft® Windows Vista® provides three default options:

- **Balanced** — This power option offers full performance when you need it and saves power during periods of inactivity.
- **Power saver** — This power option saves power on your computer by reducing system performance to maximize the life of the computer and by reducing the amount of energy consumed by your computer over its lifetime.
- **High performance** — This power option provides the highest level of system performance on your computer by adapting processor speed to your activity and by maximizing system performance.

Backing Up Your Data on Windows Vista

It is recommended that you periodically back up files and folders on your computer. To back up files:

1. Click **Start**  → **Control Panel** → **System and Maintenance** → **Welcome Center** → **Transfer files and settings**.
2. Click **Back up files** or **Back up computer**.
3. Click **Continue on Your User Account Control** dialog box and follow the instructions in the Back up Files wizard.

Backing Up Your Data on Windows XP

It is recommended that you periodically back up files and folders on your computer. To back up files:

1. Click **Start** → **All Programs** → **Accessories** → **System Tools** → **Backup**.
2. Follow the instructions in the Back up Files wizard.

Solving Problems

This section provides troubleshooting information for your computer. If you can not solve your problem using the following guidelines, see “Using Support Tools” on page 33 or “Contacting Dell” on page 50.

⚠ CAUTION: Only trained service personnel should remove the computer cover. See the *Service Manual* on the Dell Support website at support.dell.com for advanced service and troubleshooting instructions.

Network Problems

Wireless Connections

If the network connection is lost —

The wireless switch may be off. To turn on the wireless switch, slide it from the rear to the front of the computer until it clicks into place.

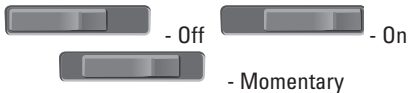

The wireless router is offline or wireless has been disabled on the computer.

- Check your wireless router to ensure it is powered on and connected to your data source (cable modem or network hub).
- Re-establish your connection to the wireless router:
 - a. Save and close any open files, and exit any open programs.
 - b. Click **Start**  → **Connect To**.
 - c. Follow the instructions on the screen to complete the setup.

Wired Connections

If the network connection is lost — The network cable is loose or damaged.

- Check the cable to ensure it is plugged in and not damaged.

The link integrity light on the integrated network connector lets you verify that your connection is working and provides information on the status:

- Green — A good connection exists between a 10-Mbps network and the computer.
- Orange — A good connection exists between a 100-Mbps network and the computer.
- Off — The computer is not detecting a physical connection to the network.

 **NOTE:** The link integrity light on the network connector is only for the wired cable connection. The link integrity light does not provide status for wireless connections.

Power Problems

If the power light is off — The computer is either turned off or is not receiving power.

- Reseat the power cable into both the power connector on the computer and the electrical outlet.
- If the computer is plugged into a power strip, ensure that the power strip is plugged into an electrical outlet and that the power strip is turned on. Also temporarily bypass power protection devices, power strips, and power extension cables to verify that the computer turns on properly.
- Ensure that the electrical outlet is working by testing it with another device, such as a lamp.
- Check the AC adapter cable connections. If the AC adapter has a light, ensure that the light on the AC adapter is on.

If the power light is solid white and the computer is not responding — The display may not be connected or powered on. Ensure that the display is properly connected and then turn it off then back on.

If the power light is blinking white — The computer is in standby mode. Press a key on the keyboard, move the pointer on the trackpad or a connected mouse, or press the power button to resume normal operation.

If the power light is solid amber — The computer has a power problem or an internal device malfunction. For assistance contact Dell, see “Contacting Dell” on page 50.

If the power light is blinking amber — The computer is receiving electrical power, but a device might be malfunctioning or incorrectly installed. You may have to remove and then reinstall the memory modules (for information on removing and replacing memory modules, see the *Service Manual* on the Dell Support website at support.dell.com).

If you encounter interference that hinders reception on your computer — An unwanted signal is creating interference by interrupting or blocking other signals. Some possible causes of interference are:

- Power, keyboard, and mouse extension cables.
- Too many devices connected to a power strip.
- Multiple power strips connected to the same electrical outlet.

Memory Problems

If you receive an insufficient memory message—

- Save and close any open files and exit any open programs you are not using to see if that resolves the problem.
- See the software documentation for minimum memory requirements. If necessary, install additional memory

(See the *Service Manual* on the Dell Support website at support.dell.com).

- Reseat the memory modules (See the *Service Manual* on the Dell Support website at support.dell.com) to ensure that your computer is successfully communicating with the memory.
- If you experience other memory problems** —
- Ensure that you are following the memory installation guidelines (see the *Service Manual* on the Dell Support website at support.dell.com).
 - Check if the memory module is compatible with your computer. Your computer supports DDR2 memory. For more information about the type of memory supported by your computer, see “Basic Specifications” on page 54.
 - Run the Dell Diagnostics (see “Dell Diagnostics” on page 36).

Solving Problems

- Reseat the memory modules (see the *Service Manual* on the Dell Support website at support.dell.com) to ensure that your computer is successfully communicating with the memory.

Lockups and Software Problems

If the computer does not start up — Ensure that the power cable is firmly connected to the computer and to the electrical outlet.

If a program stops responding — End the program:

1. Press <Ctrl><Shift><Esc> simultaneously.
2. Click **Applications**.
3. Click the program that is no longer responding
4. Click **End Task**.

If a program crashes repeatedly — Check the software documentation. If necessary, uninstall and then reinstall the program.

 **NOTE:** Software usually includes installation instructions in its documentation or on CD.

If the computer stops responding —

 **NOTICE:** You might lose data if you are unable to perform an operating system shutdown.

Turn the computer off. If you are unable to get a response by pressing a key on your keyboard or moving your mouse, press and hold the power button for at least 8 to 10 seconds until the computer turns off. Then restart your computer.

If a program is designed for an earlier Microsoft® Windows® operating system —

Run the Program Compatibility Wizard. The Program Compatibility Wizard configures a program so that it runs in an environment similar to non-Windows Vista/non-XP operating system environments.

Windows Vista

1. Click **Start**  → **Control Panel** → **Programs** → **Use an older program with this version of Windows**.
2. In the welcome screen, click **Next**.
3. Follow the instructions on the screen.

Windows XP

1. Click **Start** → **All Programs** → **Accessories** → **Program Compatibility Wizard**.
2. In the welcome screen, click **Next**.
3. Follow the instructions on the screen.

If a solid blue screen appears — Turn the computer off. If you are unable to get a response

by pressing a key on your keyboard or moving your pointer or mouse, press and hold the power button for at least 8 to 10 seconds until the computer turns off. Then restart your computer.

If you have other software problems —

- Back up your files immediately.
- Use a virus-scanning program to check the hard drive or CDs.
- Save and close any open files or programs and shut down your computer through the **Start** menu.
- Check the software documentation or contact the software manufacturer for troubleshooting information:
 - Ensure that the program is compatible with the operating system installed on your computer.
 - Ensure that your computer meets the minimum hardware requirements needed to run the software. See the software documentation for information.

Solving Problems

- Ensure that the program is installed and configured properly.
- Verify that the device drivers do not conflict with the program.
- If necessary, uninstall and then reinstall the program.

Using Support Tools

Dell Support Center

The Dell Support Center helps you find service, support, and system-specific information you need. For more information about Dell Support Center and available support tools, click the **Services** tab at support.dell.com.



Click the  icon in the taskbar to run the application. The home page provides links to access:

- Self Help (Troubleshooting, Security, System Performance, Network/Internet, Backup/Recovery, and Windows Vista)
- Alerts (technical support alerts relevant to your computer)
- Assistance from Dell (Technical Support with DellConnect™, Customer Service, Training

and Tutorials, How-To Help with Dell on Call, and Online Scan with PCCheckUp)

- About Your System (System Documentation, Warranty Information, System Information, Upgrades & Accessories)

The top of the Dell Support Center home page displays your system's model number along with its service tag and express service code.

For more information about the Dell Support Center, see the *Dell Technology Guide* on your hard drive or on the Dell Support website at support.dell.com.

System Messages

If your computer has an issue or error, it may display a System Message that will help you identify the cause and action needed to resolve the issue.

Using Support Tools

 **NOTE:** If the message you received is not listed in the following examples, see the documentation for either the operating system or the program that was running when the message appeared. Alternatively you could see the *Service Manual* on the Dell Support website at support.dell.com or see “Contacting Dell” on page 50 for assistance.

Alert! Previous attempts at booting this system have failed at checkpoint [nnnn]. For help in resolving this problem, please note this checkpoint and contact Dell Technical Support — The computer failed to complete the boot routine three consecutive times for the same error see “Contacting Dell” on page 50 for assistance.

CMOS checksum error — Possible motherboard failure or RTC battery low. Replace the battery. See the *Service Manual* on the Dell Support website at support.dell.com or see “Contacting Dell” on page 50 for assistance.

CMOS checksum error — Possible motherboard failure or RTC battery low. Replace the battery. See the *Service Manual* on the Dell Support website at support.dell.com or see “Contacting Dell” on page 50 for assistance.

CPU fan failure — CPU fan has failed. Replace the CPU fan. See the *Service Manual* on the Dell Support website at support.dell.com.

Hard-disk drive failure — Possible hard disk drive failure during HDD POST see “Contacting Dell” on page 50 for assistance.

Hard-disk drive read failure — Possible hard disk drive failure during HDD boot test see “Contacting Dell” on page 50 for assistance.

Keyboard failure — Keyboard failure or loose cable.

No boot device available — No bootable partition on hard disk drive, the hard disk drive cable is loose, or no bootable device exists.

- If the hard drive is your boot device, ensure that the cables are connected and that the drive is installed properly and partitioned as a boot device.
- Enter system setup and ensure that the boot sequence information is correct

(see the *Service Manual* on the Dell Support website at support.dell.com).

No timer tick interrupt — A chip on the system board might be malfunctioning or motherboard failure (see the *Service Manual* on the Dell Support website at support.dell.com).

USB over current error — Disconnect the USB device. Your USB device needs more power for it to function properly. Use an external power source to connect the USB device, or if your device has two USB cables, connect both of them.

NOTICE - Hard Drive SELF MONITORING SYSTEM has reported that a parameter has exceeded its normal operating range. Dell recommends that you back up your data regularly. A parameter out of range may or may not indicate a potential hard drive problem — S.M.A.R.T error, possible hard disk drive failure. This feature can be enabled or disabled in the BIOS setup (see “Contacting Dell” on page 50 for assistance).

Hardware Troubleshooter

If a device is either not detected during the operating system setup or is detected but incorrectly configured, you can use the **Hardware Troubleshooter** to resolve the incompatibility.

To start the Hardware Troubleshooter:

1. Click **Start**  → **Help and Support**.
2. Type `hardware troubleshooter` in the search field and press <Enter> to start the search.
3. In the search results, select the option that best describes the problem and follow the remaining troubleshooting steps.

Dell Diagnostics

If you experience a problem with your computer, perform the checks in “Lockups and Software Problems” on page 30 and run the Dell Diagnostics before you contact Dell for technical assistance.

It is recommended that you print these procedures before you begin.

 **NOTICE:** Dell Diagnostics works only on Dell computers.

 **NOTE:** The *Drivers and Utilities* media is optional and may not ship with your computer.

See the System Setup section in the *Service Manual* to review your computer’s configuration information, and ensure that the device that you want to test displays in the system setup program and is active.

Start the Dell Diagnostics from your hard drive or from the *Drivers and Utilities* media.

Starting Dell Diagnostics From Your Hard Drive

The Dell Diagnostics is located on a hidden diagnostic utility partition on your hard drive.

 **NOTE:** If your computer cannot display a screen image, see “Contacting Dell” on page 50.

1. Ensure that the computer is connected to an electrical outlet that is known to be working properly.
2. Turn on (or restart) your computer.
3. When the DELL™ logo appears, press <F12> immediately. Select **Diagnostics** from the boot menu and press <Enter>.

 **NOTE:** If you wait too long and the operating system logo appears, continue to wait until you see the Microsoft® Windows® desktop; then, shut down your computer and try again.

 **NOTE:** If you see a message stating that no diagnostics utility partition has been found, run the Dell Diagnostics from the *Drivers and Utilities* media.

4. Press any key to start the Dell Diagnostics from the diagnostics utility partition on your hard drive.

Starting Dell Diagnostics From the Drivers and Utilities Media

1. Insert the *Drivers and Utilities* media.
2. Shut down and restart the computer.
When the DELL logo appears, press <F12> immediately.

 **NOTE:** If you wait too long and the operating system logo appears, continue to wait until you see the Microsoft® Windows® desktop; then, shut down your computer and try again.

 **NOTE:** The next steps change the boot sequence for one time only. On the next start-up, the computer boots according to the devices specified in the system setup program.

3. When the boot device list appears, highlight **CD/DVD/CD-RW** and press <Enter>.

4. Select the **Boot from CD-ROM** option from the menu that appears and press <Enter>.
5. Type 1 to start the CD menu and press <Enter> to proceed.
6. Select **Run the 32 Bit Dell Diagnostics** from the numbered list. If multiple versions are listed, select the version appropriate for your computer.
7. When the Dell Diagnostics **Main Menu** appears, select the test you want to run.

Using Support Tools

You can restore your operating system in the following ways:

- System Restore returns your computer to an earlier operating state without affecting data files. Use System Restore as the first solution for restoring your operating system and preserving data files.
- Dell Factory Image Restore and Dell PC Restore returns your hard drive to the operating state it was in when you purchased the computer. Both procedures permanently delete all data on the hard drive and remove any programs installed after you received the computer. Use the procedures only if System Restore did not resolve your operating system problem.
- If you received an Operating System disc with your computer, you can use it to restore your operating system. However, using the Operating System disc also deletes all data on the hard drive. Use the disc only if System Restore did not resolve your operating system problem.

System Restore

The Windows operating systems provide a System Restore option which allows you to return your computer to an earlier operating state (without affecting data files) if changes to the hardware, software, or other system settings have left the computer in an undesirable operating state. Any changes that System Restore makes to your computer are completely reversible.

 **NOTICE:** Make regular backups of your data files. System Restore does not monitor your data files or recover them.

Restoring Your Operating System

 **NOTE:** The procedures in this document were written for the Windows default view, so they may not apply if you set your Dell™ computer to the Windows Classic view.

Starting System Restore in Windows Vista

1. Click **Start** .
2. In the **Start Search** box, type `System Restore` and press <Enter>.

 **NOTE:** The **User Account Control** window may appear. If you are an administrator on the computer, click **Continue**; otherwise, contact your administrator to continue the desired action.

3. Click **Next** and follow the remaining prompts on the screen.

In the event that System Restore did not resolve the issue, you may undo the last system restore.

Starting System Restore in Windows XP

1. Click **Start**→ **All Programs**→ **Accessories**→ **System Tools**→ **System Restore**.
2. In the welcome screen, click **Next**.
3. Follow the instructions on the screen.

Undoing the Last System Restore in Windows Vista

 **NOTE:** Before you undo the last system restore, save and close all open files and exit any open programs. Do not alter, open, or delete any files or programs until the system restoration is complete.

1. Click **Start** .
2. In the **Start Search** box, type `System Restore` and press <Enter>.
3. Click **Undo my last restoration** and click **Next**.

Undoing the Last System Restore in Windows XP

 **NOTE:** Before you undo the last system restore, save and close all open files and exit any open programs. Do not alter, open, or delete any files or programs until the system restoration is complete.

1. Click **Start**→ **All Programs**→ **Accessories**→ **System Tools**→ **System Restore**.
2. In the welcome screen, click **Undo my last restoration** and then click **Next**.
3. Follow the instructions on the screen.

Windows XP: Using Dell™ PC Restore

 **NOTICE:** Using Dell PC Restore permanently deletes all data on the hard drive and removes any programs or drivers installed after you received your computer. If possible, back up the data before using these options. Use PC Restore only if System Restore did not resolve your operating system problem.

 **NOTE:** Dell PC Restore by Symantec and Dell Factory Image Restore may not be available in certain countries or on certain computers.

Use Dell PC Restore only as the last method to restore your operating system. These options restore your hard drive to the operating state it was in when you purchased the computer. Any programs or files added since you received your computer—including data files—are permanently deleted from the hard drive. Data

files include documents, spreadsheets, e-mail messages, digital photos, music files, and so on. If possible, back up all data before using PC Restore.

Using PC Restore:

1. Turn on the computer.

During the boot process, a blue bar with **www.dell.com** appears at the top of the screen.

2. Immediately upon seeing the blue bar, press <Ctrl><F11>. If you do not press <Ctrl><F11> in time, let the computer finish starting, and then restart the computer again.

 **NOTICE:** If you do not want to proceed with PC Restore, click Reboot.

3. Click Restore and click **Confirm**.

The restore process takes approximately 6 to 10 minutes to complete.

4. When prompted, click **Finish** to reboot the computer.

 **NOTE:** Do not manually shut down the computer. Click **Finish** and let the computer completely reboot.

5. When prompted, click **Yes**.

The computer restarts. Because the computer is restored to its original operating state, the screens that appear, such as the End User License Agreement, are the same ones that appeared the first time the computer was turned on.

6. Click **Next**.

The System Restore screen appears and the computer restarts.

7. After the computer restarts, click **OK**.

Windows Vista: Dell Factory Image Restore

 **NOTICE:** Using Dell Factory Image Restore permanently deletes all data on the hard drive and removes any programs or drivers installed after you received your computer. If possible, back up the data before using these options. Use Dell Factory Image Restore only if System Restore did not resolve your operating system problem.

 **NOTE:** Dell Factory Image Restore may not be available in certain countries or on certain computers.

Use Dell Factory Image Restore only as the last method to restore your operating system. These options restore your hard drive to the operating state it was in when you purchased the computer. Any programs or files added since you received your computer—including data files—are permanently deleted from the hard drive. Data files include documents,

spreadsheets, e-mail messages, digital photos, music files, and so on. If possible, back up all data before using Factory Image Restore.

Dell Factory Image Restore

1. Turn on the computer. When the Dell logo appears, press <F8> several times to access the **Vista Advanced Boot Options** Window.
2. Select **Repair Your Computer**.
3. The **System Recovery Options** window appears.
4. Select a keyboard layout and click **Next**.
5. To access the recovery options, log on as a local user. To access the command prompt, type `administrator` in the **User name** field, then click **OK**.

6. Click **Dell Factory Image Restore**. The **Dell Factory Image Restore** welcome screen appears.

 **NOTE:** Depending upon your configuration, you may need to select **Dell Factory Tools**, then **Dell Factory Image Restore**.

7. Click **Next**. The **Confirm Data Deletion** screen appears.

 **NOTICE:** If you do not want to proceed with Factory Image Restore, click **Cancel**.

8. Click the checkbox to confirm that you want to continue reformatting the hard drive and restoring the system software to the factory condition, then click **Next**.

The restore process begins and may take five or more minutes to complete. A message appears when the operating system and factory-installed applications have been restored to factory condition.

9. Click **Finish** to reboot the system.

Operating System Reinstallation

Before you Begin

If you are considering reinstalling the Windows operating system to correct a problem with a newly installed driver, first try using Windows Device Driver Rollback. If Device Driver Rollback does not resolve the problem, then use System Restore to return your operating system to the operating state it was in before you installed the new device driver. See “Using Microsoft Windows System Restore” on page 38.

 **NOTICE:** Before performing the installation, back up all data files on your primary hard drive. For conventional hard drive configurations, the primary hard drive is the first drive detected by the computer.

To reinstall Windows, you need the following items:

- *Dell Operating System* media
- *Dell Drivers and Utilities* media

Restoring Your Operating System

 **NOTE:** The *Dell Drivers and Utilities* media contains drivers that were installed during the assembly of the computer. Use the Dell Drivers and Utilities media to load any required drivers. Depending on the region from which you ordered your computer, or whether you requested the media, the *Dell Drivers and Utilities* media and *Operating System* media may not ship with your computer.

Reinstalling Windows

The reinstallation process can take 1 to 2 hours to complete. After you reinstall the operating system, you must also reinstall the device drivers, virus protection program, and other software.

1. Save and close any open files and exit any open programs.
2. Insert the *Operating System* disc.
3. Click **Exit** if the **Install Windows** message appears.

4. Restart the computer.
5. When the DELL logo appears, press <F12> immediately.

 **NOTE:** If you wait too long and the operating system logo appears, continue to wait until you see the Microsoft® Windows® desktop; then, shut down your computer and try again.

 **NOTE:** The next steps change the boot sequence for one time only. On the next start-up, the computer boots according to the devices specified in the system setup program.

6. When the boot device list appears, highlight **CD/DVD/CD-RW Drive** and press <Enter>.
7. Press any key to **Boot from CD-ROM**. Follow the instructions on the screen to complete the installation.

Getting Help

If you experience a problem with your computer, you can complete the following steps to diagnose and troubleshoot the problem:

1. See “Solving Problems” on page 26 for information and procedures that pertain to the problem your computer is experiencing.
2. See “Dell Diagnostics” on page 36 for procedures on how to run Dell Diagnostics.
3. Fill out the “Diagnostic Checklist” on page 49.
4. Use Dell’s extensive suite of online services available at Dell Support (support.dell.com) for help with installation and troubleshooting procedures. See “Online Services” on page 46 for a more extensive list of Dell Support online.
5. If the preceding steps have not resolved the problem, see “Contacting Dell” on page 50.

 **NOTE:** Call Dell Support from a telephone

near or at the computer so that the support staff can assist you with any necessary procedures.

 **NOTE:** Dell’s Express Service Code system may not be available in all countries.

When prompted by Dell’s automated telephone system, enter your Express Service Code to route the call directly to the proper support personnel. If you do not have an Express Service Code, open the **Dell Accessories** folder, double-click the **Express Service Code** icon, and follow the directions.

 **NOTE:** Some of the following services are not always available in all locations outside the continental U.S. Call your local Dell representative for information on availability.

Technical Support and Customer Service

Dell's support service is available to answer your questions about Dell hardware. Our support staff uses computer-based diagnostics to provide fast, accurate answers.

To contact Dell's support service, see "Before You Call" on page 49 and then see the contact information for your region or go to support.dell.com.

DellConnect™

DellConnect is a simple online access tool that allows a Dell service and support associate to access your computer through a broadband connection, diagnose your problem and repair it all under your supervision. For more information, go to support.dell.com and click **DellConnect**.

Online Services

You can learn about Dell products and services on the following websites:

- www.dell.com
- www.dell.com/ap (Asian/Pacific countries only)
- www.dell.com/jp (Japan only)
- www.euro.dell.com (Europe only)
- www.dell.com/la (Latin American and Caribbean countries)
- www.dell.ca (Canada only)

You can access Dell Support through the following websites and e-mail addresses:

Dell Support websites

- support.dell.com
- support.jp.dell.com (Japan only)
- support.euro.dell.com (Europe only)

Dell Support e-mail addresses

- **mobile_support@us.dell.com**
- **support@us.dell.com**
- **la-techsupport@dell.com** (Latin America and Caribbean countries only)
- **apsupport@dell.com** (Asian/Pacific countries only)

Dell Marketing and Sales e-mail addresses

- **apmarketing@dell.com** (Asian/Pacific countries only)
- **sales_canada@dell.com** (Canada only)

Anonymous file transfer protocol (FTP)

- **ftp.dell.com**

Log in as user: `anonymous`, and use your e-mail address as your password.

AutoTech Service

Dell's automated support service—AutoTech—provides recorded answers to the questions

most frequently asked by Dell customers about their portable and desktop computers.

When you call AutoTech, use your touch-tone telephone to select the subjects that correspond to your questions. For instructions on accessing the telephone number to call your region, see “Contacting Dell” on page 50.

Automated Order-Status Service

To check on the status of any Dell products that you have ordered, you can go to **support.dell.com**, or you can call the automated order-status service. A recording prompts you for the information needed to locate and report on your order. For the telephone number to call your region, see “Contacting Dell” on page 50 for problems with your order.

If you have a problem with your order, such as missing parts, wrong parts, or incorrect billing, contact Dell for customer assistance. Have your invoice or packing slip handy when you call. For the telephone number to call for your region, see “Contacting Dell” on page 50.

Product Information

If you need information about additional products available from Dell, or if you would like to place an order, visit the Dell website at **www.dell.com**. For the telephone number to call for your region or to speak to a sales specialist, see “Contacting Dell” on page 50.

Returning Items for Repair Under Warranty or for Credit

Prepare all items being returned, whether for repair or credit, as follows:

1. Call Dell to obtain a Return Material Authorization Number, and write it clearly and prominently on the outside of the box.
2. For the telephone number to call for your region, see “Contacting Dell” on page 50.
3. Include a copy of the invoice and a letter describing the reason for the return.
4. Include a copy of the Diagnostics Checklist (see “Diagnostic Checklist” on page 49), indicating the tests that you have run and any error messages reported by the Dell Diagnostics (see “Dell Diagnostics” on page 36).
5. Include any accessories that belong with the item(s) being returned (power cables, software, guides, and so on) if the return is for credit.
6. Pack the equipment to be returned in the original (or equivalent) packing materials.
7. You are responsible for paying shipping expenses. You are also responsible for insuring any product returned, and you assume the risk of loss during shipment to Dell. Collect On Delivery (C.O.D.) packages are not accepted.
8. Returns that are missing any of the preceding requirements will be refused at Dell’s receiving dock and returned to you.

Before You Call

 **NOTE:** Have your Express Service Code ready when you call. The code helps Dell's automated-support telephone system direct your call more efficiently. You may also be asked for your Service Tag (located on the back or bottom of your computer).

Remember to fill out the following Diagnostics Checklist. If possible, turn on your computer before you call Dell for assistance and call from a telephone at or near the computer. You may be asked to type some commands at the keyboard, relay detailed information during operations, or try other troubleshooting steps possible only at the computer itself. Ensure that the computer documentation is available.

Diagnostic Checklist

- Name:
- Date:
- Address:
- Phone number:
- Service Tag (bar code on the back or bottom of the computer):
- Express Service Code:
- Return Material Authorization Number (if provided by Dell support technician):
- Operating system and version:
- Devices:
- Expansion cards:
- Are you connected to a network? Yes /No
- Network, version, and network adapter:
- Programs and versions:

Getting Help

See your operating system documentation to determine the contents of the computer's start-up files. If the computer is connected to a printer, print each file. Otherwise, record the contents of each file before calling Dell.

- Error message, beep code, or diagnostic code:
- Description of problem and troubleshooting procedures you performed:

Contacting Dell

For customers in the United States, call 800-WWW-DELL (800-999-3355).

 **NOTE:** If you do not have an active Internet connection, you can find contact information on your purchase invoice, packing slip, bill, or Dell product catalog.

Dell provides several online and telephone-based support and service options. Availability varies by country and product, and some services may not be available in your area.

To contact Dell for sales, technical support, or customer service issues:

1. Visit **support.dell.com**.
2. Verify your country or region in the **Choose A Country/Region** drop-down menu at the bottom of the page.
3. Click **Contact Us** on the left side of the page.
4. Select the appropriate service or support link based on your need.
5. Choose the method of contacting Dell that is convenient for you.

Finding More Information and Resources

If you need to:**See:**

reinstall your operating system.

your Operating System disc.

run a diagnostic program for your computer, reinstall Notebook System Software (NSS), or update drivers for your computer, and readme files.

the *Drivers and Utilities* disc.



NOTE: Drivers and documentation updates can be found on the Dell™ Support website at **support.dell.com**.

learn more about your operating system, maintaining peripherals, RAID, Internet, Bluetooth®, networking, and e-mail.

the *Dell Technology Guide* installed on your hard drive.

upgrade your computer with new or additional memory, or a new hard drive.

the *Service Manual* on the Dell Support website at **support.dell.com**.

reinstall or replace a worn or defective part.



NOTE: In some countries, opening and replacing parts of your computer may void your warranty. Check your warranty and return policies before working inside your computer.

If you need to:

find safety best practices information for your computer.

review Warranty information, Terms and Conditions (U.S. only), Safety instructions, Regulatory information, Ergonomics information, and End User License Agreement.

find your Service tag/Express Service Code— You must use the service tag to identify your computer on **support.dell.com** or to contact technical support.

find drivers and downloads.

access technical support and product help.

check on your order status for new purchases.

find solutions and answers to common questions.

locate information for last-minute updates about technical changes to your computer or advanced technical-reference material for technicians or experienced users.

See:

the safety and regulatory documents that shipped with your computer and also see the Regulatory Compliance Homepage at: **www.dell.com/regulatory_compliance.**

the back or bottom of your computer.

the Dell™ Support website at **support.dell.com.**

Basic Specifications

System Model

Dell Inspiron 1525/1526

This section provides basic information that you may need when setting up, updating drivers for, and upgrading your computer. For more detailed specifications, see the *Service Manual* on the Dell Support website at support.dell.com.



NOTE: Offerings may vary by region.

For more information regarding the configuration of your computer, click

Start  → **Help and Support** and select the option to view information about your computer.

Processor

Types

AMD® Turion™ 64 X2 Dual-Core Mobile Technology

AMD® Athlon™ 64 X2 Dual-Core Mobile Technology

AMD® Sempron™ Mobile Technology

Intel® Celeron™

Intel® Core™ Duo

Intel® Core™2 Duo

Intel® Pentium® Dual-Core

L2 cache

256 KB or 512 KB per core depending on model (AMD)

1 MB, 2 MB, or 4 MB per core depending on model (Intel)

Processor

External bus frequency	1600 MT HyperTransport(AMD) 533/667/800 MHz (Intel)
------------------------	---

Express Card

ExpressCard controller	ATI RS690T Intel ICH8M
ExpressCard connector	one ExpressCard slot (54 mm)
Cards supported	ExpressCard/34 (34 mm) ExpressCard/54 (54 mm) 1.5 V and 3.3 V
ExpressCard connector size	26 pins

Memory

Connectors	two internally-accessible SO-DIMM sockets
Capacities	512 MB, 1 GB, and 2 GB
Memory type	667 MHz DDR2 SODIMM
Minimum memory	1 GB, 1.5 GB, 2 GB, 3 GB, 4 GB
Maximum memory	4 GB

 **NOTE:** For instructions on upgrading your memory, see the *Service Manual* on the Dell Support website at support.dell.com.

 **NOTE:** In order to take advantage of the dual channel bandwidth capability, both memory slots must be populated and must match in size.

Basic Specifications

Computer Information

System Chipset	AMD M690T Chipset with ATI™ Radeon® X1270 Graphics or Mobile Intel Express GM 965
Data bus width	64 bits
DRAM bus width	dual channel (2) 64-bit buses
Processor address bus width	36 bits (Intel) and 32 bits (AMD)
Flash EPROM	2 MB
PCI Bus	32 bits

Communications

Modem type	v.92 56K Data/FAX MDC
Modem controller	softmodem
Modem interface	Intel High-Definition Audio
Network adapter	10/100 Ethernet LAN on system board
Wireless	internal WLAN, WWAN, UWB (optional) Mini-Cards WWAN ExpressCard Bluetooth® wireless technology

Video

video controller	ATI Radeon® X1270 Graphics Controller (AMD) or Intel 965 GM (Intel)
video memory	dynamic based on system memory capacity
LCD interface	LVDS
TV support	NTSC or PAL in S-video, composite, and component modes

Camera (optional)

Pixel	2.0 megapixel
Video resolution	640x480 at 30fps
Diagonal viewing angle	66°

Audio

Audio type	2 channel High Definition Audio
Audio controller	Sigmatel STAC9228 Codec
Internal Interface	Intel High Definition Audio
External Interface	microphone-in connector, stereo headphones/ speakers connector

Basic Specifications

Audio

Speaker	two 4-ohm speakers
Internal speaker amplifier	1 Watt per channel into 4 ohms
Volume controls	program menus, media control buttons

Ports and Connectors

Network adapter	RJ-45 port
Modem Connector	RJ-11 port
S-video TV-out	7-pin mini-DIN connector (optional S-video to composite video adapter cable)
USB	four 4-pin USB 2.0-compliant connectors
Network adapter	RJ-45 port
Video	15-hole connector

Ports and Connectors

HDMI	one 29 pin Type B HDMI connector.
------	-----------------------------------

Display

Type (active-matrix TFT)	15.4-inch WXGA 15.4-inch WXGA with TrueLife 15.4-inch WXGA+ with TrueLife 15.4-inch WSXGA+with TrueLife
--------------------------	--

Dimensions:

Height	207.0 mm (8.1 in)
Width	331.2 mm (13.0 in))
Diagonal	391.2 mm (15.4 in)

Display

Maximum resolution	1280 x 800 at 262 K colors (WXGA and WXGA with TrueLife), 1440 x 900 at 262 K colors (WXGA+ with TrueLife), 1680 x 1050 at 262 K colors (WSXGA+with TrueLife)
Refresh rate	60 Hz
Operating angle	0° (closed) to 155°
Luminance	250 min. 300 typ. cd/m ² (LED 5 point avg) 200 min. 220 typ. cd/m ² (CCFL 5 point avg)

Display

<i>Viewing Angles:</i>	
Horizontal	±40° (WXGA, WXGA with TrueLife) ±55° (WXGA+ with TrueLife) ±60° (WSXGA+ with TrueLife)
Vertical	+15°/–30° (WXGA, WXGA with TrueLife) ±45° (WXGA+ with TrueLife) +40°/–50° (WSXGA+ with TrueLife)

Basic Specifications

Display

Pixel pitch	0.258 mm (WXGA, WXGA with TrueLife) 0.2304 mm (WXGA+ with TrueLife) 0.197 mm (WSXGA+with TrueLife)
Controls	brightness can be controlled through keyboard shortcuts (see <i>Dell Technology Guide</i> for more information.)

Keyboard

Number of keys	87 (U.S. and Canada); 88 (Europe); 91 (Japan)
Layout	QWERTY/AZERTY/ Kanji

Touchpad

X/Y position resolution (graphics table mode)	240 cpi
<i>Size:</i>	
Width	73.7-mm (2.9-in) sensor-active area
Height	34.0-mm (1.3-in) rectangle

Battery

Type	6-cell smart lithium ion or 6 cell smart lithium polymer
Depth	57.2mm (2.25 in)
Height	20mm (0.78 in)
Width	205.1 mm (8.07 in)
Weight	0.35 kg (0.77 lb) (6-cell)
Voltage	11.1 VDC
Charge time at room temperature (approximate):	4 hours
Computer off	

Battery

Operating time	Battery operating time varies depending on operating conditions and can be significantly reduced under certain power-intensive conditions. <i>See Dell Technology Guide for more information.</i>
Life span (approximate)	300 discharge/charge cycles
	<i>Temperature range:</i>
Operating	0° to 35°C (32° to 95°F)
Storage	-40° to 65°C (-40° to 149°F)
Coin-cell battery	CR-2032

Basic Specifications

AC Adapter

Input voltage	100–240 VAC
Input current (maximum)	1.5 A/1.6 A
Input frequency	50–60 Hz
Output power	65 W or 90 W
Output current (65 W)	3.34 A (continuous) 4.34 A (peak for 4-second pulse)
Rated output voltage	19.5 ± 1 VDC
<i>Dimensions:</i>	
Height	28.2 mm (1.11 in)
Width	57.9 mm (2.28 in)
Depth	137.2 mm (5.4 in)
Weight (with cables)	0.4 kg (0.9 lb)

AC Adapter

Temperature range:

Operating	0° to 35°C (32° to 95°F)
Storage	-40° to 65°C (-40° to 149°F)

Physical

Height	24.1 mm to 37.5 mm (0.9 in to 1.47 in)
Width	357 mm (14.05 in)
Depth	256 mm (10.08 in)
Weight (with 4-cell battery):	
Configurable to less than	2.7 kg (5.9 lb)

Computer Environment*Temperature range:*

Operating	0° to 35°C (32° to 95°F)
Storage	-40° to 65°C (-40° to 149°F)

Relative humidity (maximum):

Operating	10% to 90% (noncondensing)
Storage	5% to 90% (noncondensing)

Maximum vibration (using a random-vibration spectrum that simulates user environment):

Operating	0.66 GRMS
-----------	-----------

Computer Environment

Maximum shock (measured with hard drive in head-parked position and a 2-ms half-sine pulse):

Operating	110 G
Storage	163 G

Altitude (maximum):

Operating	-15.2 to 3048 m (-50 to 10,000 ft)
Storage	-15.2 to 10,668 m (-50 to 35,000 ft)

Airborne contaminant level	G2 or lower as defined by ISA-S71.04-1985
----------------------------	---

Index

A

AC adapter

size and weight **62**

airflow, allowing **5**

AutoTech **47**

B

backups

creating **25**

C

calling Dell **49**

CDs, playing and creating **23**

chipset **56**

computer capabilities **23**

computer, setting up **5**

connect(ing)

to the Internet **8**

conserving energy **24**

Contacting Dell online **50**

customer service **45**

customizing

your desktop **23**

your energy settings **24**

D

damage, avoiding **5**

data, backing up **25**

DellConnect **46**

Dell Diagnostics **36**

Dell Factory Image Restore **38**

Dell Support Center **33**

Dell support website **53**
Dell Technology Guide
 for further information **52**
Diagnostic Checklist **49**
drivers and downloads **53**
DVDs, playing and creating **23**

E

email addresses
 for technical support **47**
energy
 conserving **24**
expansion bus **56**

F

finding more information **52**
FTP login, anonymous **47**

H

hardware problems
 diagnosing **35**
Hardware Troubleshooter **35**
help
 getting assistance and support **46**

I

Internet connection **8**
ISP
 Internet Service Provider **8**

M

memory problems
 solving **29**
memory support **55**

N

- network connection
 - fixing **27**
- network speed
 - testing **27**

O

- order status **47**

P

- power problems, solving **28**
- power strips, using **6**
- problems, solving **26**
- processor **54**
- products
 - information and purchasing **48**

R

- reinstalling Windows **38**
- resources, finding more **52**
- restoring factory image **42**

S

- setup, before you begin **5**
- shipping products
 - for return or repair **48**
- software features **23**
- software problems **30**
- solving problems **26**
- specifications **54**
- support email addresses **47**
- support sites
 - worldwide **46**

System Messages **33**

system reinstall options **39**

System Restore **38**

T

technical support **45**

V

ventilation, ensuring **5**

W

warranty returns **48**

Windows, reinstalling **38**

Windows Vista®

 Program Compatibility Wizard **31**

 reinstalling **44**

 setup **8**

Windows XP **31**

wired network

 network cable, connecting **7**

wireless network connection **26**

wireless switch **6, 13, 26**



Printed in the U.S.A.

www.dell.com | support.dell.com



OY465HA01

Printed in Malaysia.

www.dell.com | support.dell.com



OY465HA01

Printed in China.

Printed on recycled paper.

www.dell.com | support.dell.com



OY465HA01

Printed in Ireland.

www.dell.com | support.dell.com



OY465HA01

Printed in Brazil.

www.dell.com | support.dell.com



OY465HA01