



OPERATOR'S MANUAL

**MOST
WANTED**

V 3.1



© **LAI GAMES**

ISO 9001 CERTIFIED ORGANIZATION



ISO 9001: 2008 Cert No. 17460



TABLE OF CONTENTS

<u>SAFETY PRECAUTIONS.....</u>	<u>1</u>
MACHINE INSTALLATION AND INSPECTION	2
INSTALLING GUN BRACKET AND LEATHER HOLSTER.....	3
INTRODUCTION	5
SPECIFICATIONS	6
HOW TO PLAY	7
<u>OPERATION</u>	<u>8</u>
<i>OPERATIONAL DIAGRAM</i>	<i>8</i>
<i>POWER UP.....</i>	<i>8</i>
<i>ATTRACT MODE</i>	<i>8</i>
<i>GAME PLAY MODE.....</i>	<i>8</i>
GUN ALIGNMENT MODE.....	9
<i>GUN ALIGNMENT SCREEN</i>	<i>9</i>
TEST MODE	10
<i>TEST MODE MAIN SCREEN V3.1</i>	<i>10</i>
<i>TEST MODE PROCEDURE.....</i>	<i>10</i>
<i>TEST MODE OPTIONS DETAILED.....</i>	<i>11</i>
<i>SETTINGS.....</i>	<i>12</i>
<i>SETTINGS SCREEN.....</i>	<i>12</i>
<i>SETTINGS DETAILED.....</i>	<i>13</i>
<i>AUDITS.....</i>	<i>14</i>
<i>AUDITS SCREEN.....</i>	<i>15</i>
<i>PARTS OF AUDITS SCREEN</i>	<i>15</i>
<i>AUDITS DETAILED.....</i>	<i>16</i>
<i>SWITCH TEST.....</i>	<i>16</i>
<i>SWITCH TEST SCREEN.....</i>	<i>17</i>
<i>SCREEN TEST.....</i>	<i>18</i>
<i>SCREEN TEST MAIN SCREEN.....</i>	<i>18</i>
<i>SCREEN TEST DETAILED</i>	<i>18</i>
<i>SOUND TEST.....</i>	<i>19</i>
<i>SOUND TEST SCREEN.....</i>	<i>19</i>
<i>SOUND TEST DETAILED</i>	<i>19</i>
ERRORS AND TROUBLESHOOTING	20
<i>TROUBLESHOOTING GAME ERRORS</i>	<i>20</i>
FUSE INFORMATION	21
<i>FUSE LOCATION DIAGRAM.....</i>	<i>21</i>
<u>SECTION A: SERVICE INSTRUCTIONS</u>	<u>22</u>



LOCATING AND ACCESSING PARTS 23
PARTS LOCATION DIAGRAM..... 23
PARTS DESCRIPTION..... 25
LAMPS 27
MAINTENANCE 28
SECTION B: TECHNICAL DETAILS..... 29
MAINS VOLTAGE ADJUSTMENT 30
TICKET DISPENSER REFERENCE GUIDE 31
MOST WANTED JAMMA & CONNECTOR LIST..... 36
3D EXPLODE PARTS 37
MOST WANTED WIRING DIAGRAM..... 38



SAFETY PRECAUTIONS

The following safety precautions and advisories are used throughout this manual and are defined as follows.

*** WARNING! ***

Disregarding this text could result in serious injury.

*** CAUTION! ***

Disregarding this text could result in damage to the machine.

*** NOTE! ***

- An advisory text to hint or help understanding.



BE SURE TO READ THE FOLLOWING



*** WARNING! ***

***Always** turn **OFF** Mains AC power and unplugged the game, before opening or replacing any parts.*

***Always** when unplugging the game from an electrical outlet, grasp the plug, not the line cord.*

***Always** connect the Game Cabinet to grounded electrical outlet with a securely connected ground line.*

***Do Not** install the Game Cabinet outdoors or in areas of high humidity, direct water contact, dust, high heat or extreme cold.*

***Do Not** install the Game Cabinet in areas that would present an obstacle in case of an emergency, i.e. near fire equipment or emergency exits.*

*** CAUTION! ***

***Always** use a Digital Multimeter, logic tester or oscilloscope for testing integrated circuit (IC) logic PC boards. The use of a continuity tester is not permitted.*

***Do Not** Connect or disconnect any of the integrated circuit (IC) logic PC boards while the power is **ON**.*

***Do Not** use any fuse that does not meet the specified rating.*

***Do Not** Subject the game cabinet to extreme temperature variations. Reliability of electrical components deteriorates rapidly over 60 °C.*



MACHINE INSTALLATION and INSPECTION

When installing and inspecting “*Most Wanted*”, be very careful of the following points and pay attention to ensure that the players can enjoy the game safely.

- Be sure to turn the power **OFF** before working on the machine.

*** WARNING! ***

***Always** Turn **OFF** mains power before removing safety covers and refit all safety covers when work is completed.*

- Make sure the power cord is not exposed on the surface (floor, ground, etc.) where people walk through.
- Check that the rubber glide feet levelers are set evenly on the floor so that the game cabinet is unable to roll and is stable.
- Always make complete connections for the integrated circuit (IC) logic PC Boards and other connectors. Insufficient insertion can damage the electrical components.

*** CAUTION! ***

***Before** switching the machine on be sure to check that it has been set on the correct voltage for your area!*

***Refer** to the mains voltage adjustment section of this. Machines are normally shipped on 220V AC unless otherwise specified.*

- Only qualified personnel should inspect or test the integrated circuit (IC) logic PC Boards.
- If any integrated circuit (IC) logic PC Boards should need servicing. Please contact the nearest **LAI GAMES** distributor. (*Refer to the back page of this manual*)

INSTALLING GUN BRACKET AND LEATHER HOLSTER

For transportation safety we put the gun, bracket and leather holster with 4 L bolts M5x 15 on top of the control panel,



Installation process, before proceed you need to equipped with M5 Allen key.

Step 1.

Take the gun, bracket and leather holster from control panel. As shown down here



Step 2.

Unscrew 4 L bolts on each side of control panel, as shown below,



Step 3,
Open the control panel by pull the whole control panel as shown below,



Step 4,
Position the bracket on it's hole until all the four hole match with bracket inside the control panel as shown below,

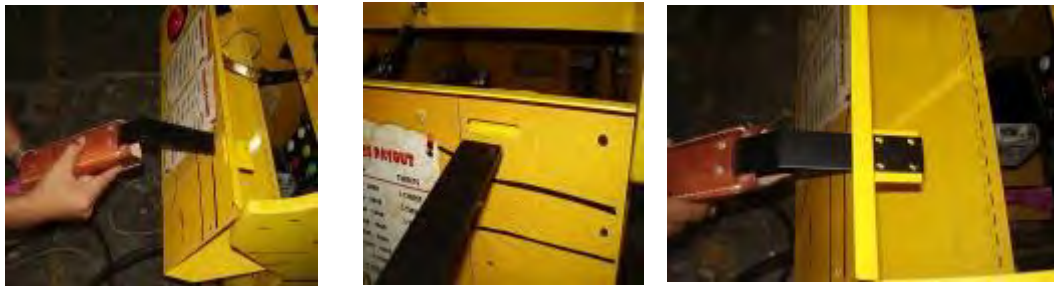

Step 5,
Screw the 4 supplied L bolts to hold the bracket as shown below,



Step 6 Finishing,
Close the control panel and screw the 4 L bolts to its position,

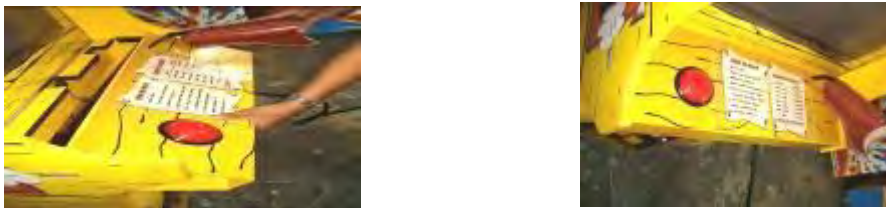



INTRODUCTION

CONGRATULATIONS! You have just bought the “*Most Wanted*”, another great product from **LAI GAMES**. In the old Wild West, it was easy to tell the difference between the good guys and the villains. In this fast action shooting game, players have to make quick decisions to shoot only the bad guys and leave everyone else alive.

We hope you take the time to read this manual and learn about the many other features and user-friendly adjustments that can be made to “fine-tune” the game for maximum earning potential.

DESCRIPTION

The “*Most Wanted*” is a single player fast action shooting game. Players aim to shoot as many villains before the game timer expires. The more villains hit, the more tickets won.

PACKAGING

- At delivery, the machine should arrive in good condition. To move the packaged machine for transport or placement, use a forklift and take care not to hit the package or stack heavy objects on top, as this may cause damage to the machine.

CONTENTS

- The “Most Wanted” cabinet
- Keys: 2 x coin door keys
 2 x back door keys
 2 x ticket door key
- Operator’s manual
- IEC Power Cord (In cash box)
- Parts & Accessories (In cash box)



SPECIFICATIONS

DIMENSIONS

- Weight: 160 kg (353lb)
- Height: 2134.5mm (84")
- Width: 989 mm (39")
- Length: 895 mm (35.2")
- Power: Maximum 450 W – (220V @ 2.1A)(120V @ 3.8A)

ELECTRIC SUPPLY

- The game has the option to operate on a 110V, 120V, 220V or 240V AC 50/60Hz single phase mains electric supply.
The supply must be a three wire grounded supply.

*** CAUTION! ***

Before switching the machine on be sure to check that it has been set on the correct voltage for your area!

Please Refer to the mains voltage adjustment section of this manual. Machines are normally shipped on 220V AC unless otherwise specified.

LOCATION REQUIREMENTS

- Ambient temperature: between 5°C and 40°C.
- Ambient humidity: Low
- Ambient U.V. radiation: Very low
- Vibrations level: Low

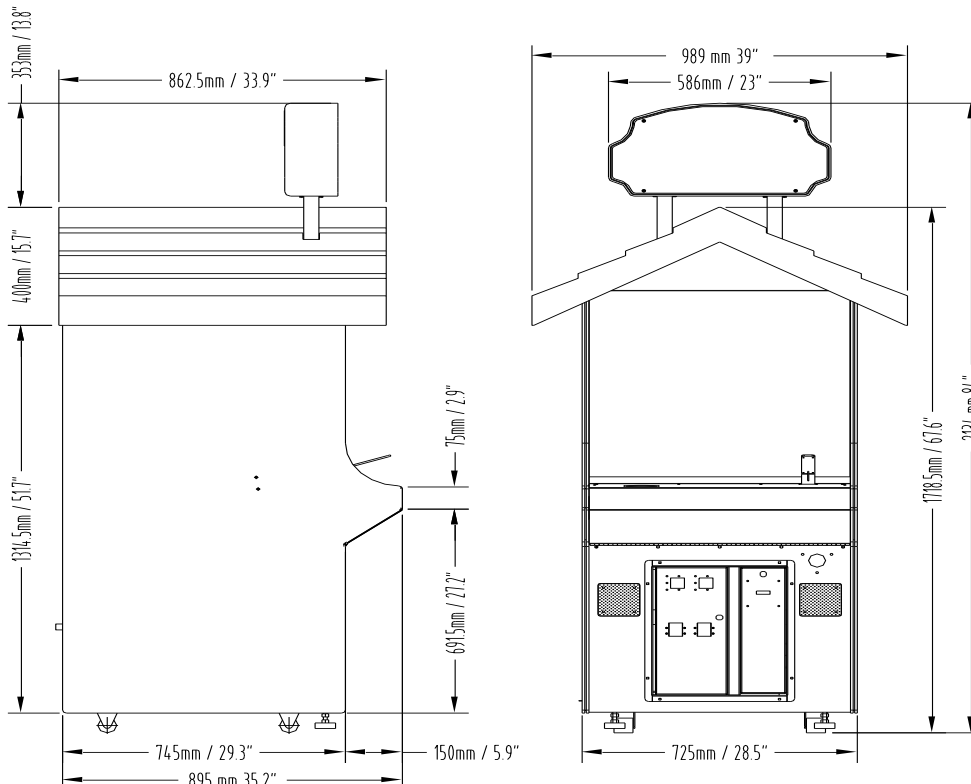



HOW TO PLAY

PLAYERS SHOOT VILLAINS TO SCORE POINTS FOR TICKETS

- Insert coin/s for credits.
- Take the Gun from the holster and Press the Start Button to begin a game.
- Use the Gun to shoot the villains when the windows open to score points.
- The faster you can shoot the villains the more sets of windows are available before the game timer expires.
- Shooting the innocent will result in lost time and points.
- Bonus Round can be played by shooting a certain number of villains before the game timer expires.
- In Bonus Round, try to shoot all the villains before the window sets change.
- Tickets are awarded based on points scored during the game.
- At the end of a game, Extra Tickets can be won by shooting one of the closed windows in the Mystery Bonus Jackpot.
- Players with the highest scores can use the gun to enter their initials for display in the High Score table.





OPERATION

The “*Most Wanted*” game has five operational modes: Power Up mode, Attract mode, Game Play mode, Gun Alignment Mode and Test Mode.

OPERATIONAL DIAGRAM

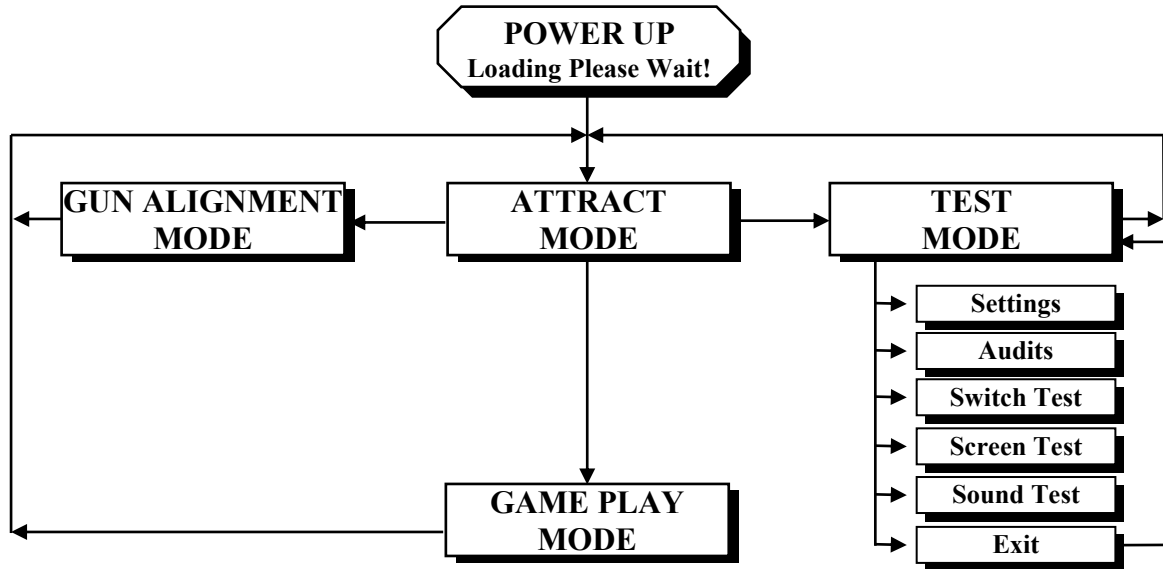

POWER UP

- The Power Up mode is active when power is first applied to the game. During this time, a **LOADING PLEASE WAIT!** phrase will appear on screen. Please wait for about 10 seconds for the loading to complete.

ATTRACT MODE

- The Attract mode provides game sound and display while the game is not being played. This feature is to attract potential customers to play the game.

GAME PLAY MODE

- The Most Wanted has two play modes. The Standard *Coin Play* mode, where a coin, or coins are inserted. Or *Free Play* where no coins are necessary.

COIN PLAY

The *Coin Play* mode is entered from Attract mode, by inserting coins in any of the two coin slots on the front of the machine cabinet, then following the instructions in the “How to Play” section of this manual.

FREE PLAY

The *Free Play* mode is entered by setting the Coin per Credit to “**free**”.

For a single free game, just press the Service button once. When issuing single free games in this manner, Tickets can be won as normal.



GUN ALIGNMENT MODE

The Most Wanted has a *Gun Alignment Mode* allowing you to set the calibration for gun accuracy. To enter *Gun Alignment Mode*, press the yellow Gun Calibration push button located on the service bracket.

The screen will display a background with white and red targets; one will appear in the upper left of the screen and the other in the lower right. To calibrate the gun alignment, aim and shoot first the upper left target and then the lower right target. The game will exit into Attract Mode automatically.
(Refer to the *Gun Alignment Screen* below).

GUN ALIGNMENT SCREEN





TEST MODE

The Most Wanted has *Test Mode* from which you can adjust the game settings, see the audits, do switch test, screen test, and sound test. From the main screen of the Test Mode you can choose one of the six options available that is suitable to your need. (Refer to the Test Mode Main Screen below).

TEST MODE MAIN SCREEN V3.1

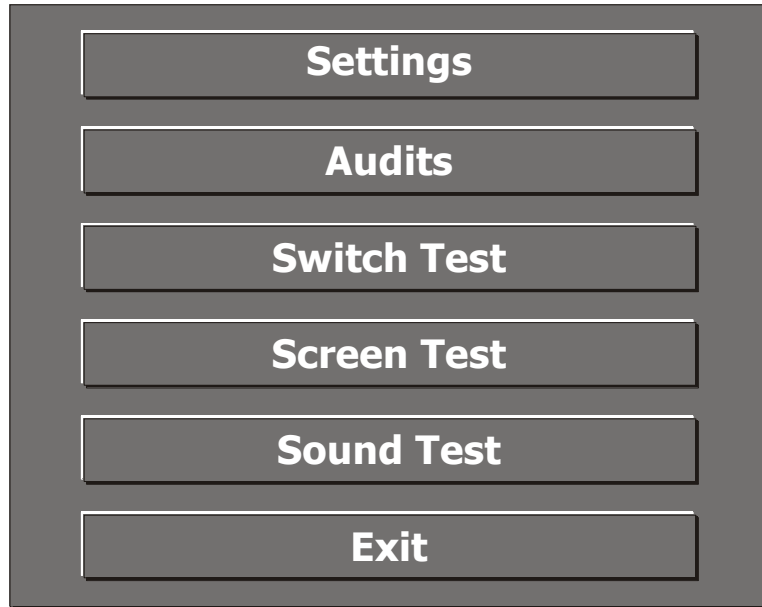

TEST MODE PROCEDURE

- **ENTER** The *Test Mode* can be entered by pressing the red Test button located on the service bracket while in Attract mode once.
- **SELECT** The green Service button is pressed to step through each of the Test Mode options, starting from **Settings** stepping down through **Exit** and then looping again until the mode is exited.

*** NOTE! ***

- By holding down the SERVICE button, you can step through the options quicker.

- **ENTERING OPTIONS SETTINGS**

The two white Up and Down buttons are used to enter the chosen Test Mode option.

- **EXIT** The *Test mode* is exited by highlighting the **Exit** using Service button and pressing one of the white buttons.



SERVICE BRACKET



TEST MODE OPTIONS DETAILED

■ SETTINGS

Highlighting **SETTINGS** and pressing one of the two white buttons will advance to the Settings screen. In this screen you can do some adjustments related to the game.

■ AUDITS

Highlighting **AUDITS** and pressing one of the two white buttons will advance to the Audits screen. In this screen you can see the audits of the game.

■ SWITCH TEST

This test is used to test all the game switches. To enter the Switch Test, highlight **SWITCH TEST** in the Test Mode main screen and press one of the white buttons.

■ SCREEN TEST

This test is used to test the game screen. To enter the Screen Test, highlight **SCREEN TEST** in the Test Mode main screen and press one of the white buttons.

■ SOUND TEST

This test is used to test the audio channel of the game. To enter the Sound Test, highlight **SOUND TEST** in the Test Mode main screen and press one of the white buttons.

■ EXIT

To exit the Test Mode main screen, highlight **EXIT** in the Test Mode main screen and press one of the white buttons.



SETTINGS

- **ENTER** The Settings can be entered by highlighting **SETTINGS** while in Test Mode main screen and pressing the white buttons. Or, by pressing the red Test button while in Attract mode once, highlighting **SETTINGS**, and pressing the white buttons.
- **SELECT** The Service button is pressed to step through each of the adjustment configurations, starting from the highlighted **“Cancel”** dialog button, stepping through each adjustment and then looping again until the Settings is exited.
- **CHANGE** The two white buttons change the displayed value, Up to increase and Down to decrease. For the dialog buttons, either of the white buttons will activate the highlighted dialog button.

*** NOTE! ***

- Certain adjustments have a fast adjustment feature. By holding down the UP or DOWN push buttons, the values step through quicker.

- **EXIT** The Settings is exited into Test Mode main screen by highlighting and pressing one of the white buttons on the **“OK”** dialog button to exit & save the changes. Or by highlighting and pressing the white buttons on the **“CANCEL”** dialog button to exit without saving the changes.

SETTINGS SCREEN

Base Time :	45	OK	Cancel
Coins per Credit :	1	Reset Default	
Bonus Round Time :	15		
Villains Hit for Bonus :	50		
Mystery Bonus Average :	5		
Jackpot Tickets :	10		
Ticket Payout :	On		
Attract Mode Sounds :	On		
Calibrate X :	0		
Calibrate Y :	0		

Ticket Payout Table

Ticket(s)	Score(s)
1	0
2	1500
3	3000
4	4500
5	6000
6	7500
+1	3000



SETTINGS DETAILED

■ CANCEL

(Exit Without Save Changes)

Highlighting the **CANCEL** dialog button and pressing either of the two white buttons will exit the *Settings* **without** save any changes made.

■ OK

(Exit & Save Changes)

Highlighting the **OK** dialog button and pressing either of the two white buttons will exit the *Settings* and save any changes made.

■ RESET DEFAULT

(Reset all Adjustments to Default)

Highlighting the **RESET DEFAULT** dialog button and pressing either of the two white buttons will reset all adjustments back to factory defaults.

■ BASE TIME

(Default 45) (Adjustable 45 – 90, Steps ± 15)

This variable sets the minimum time a game will play, this is regardless if player hits or misses any villains.

■ COINS PER CREDIT

(Default 1) (Adjustable Free, 1 – 5, Steps ± 1)

This sets the number of coins that need to be inserted into the coin mechanisms for each credit. The setting “Free” will sets the game in Free Play Mode.

■ BONUS ROUND TIME

(Default 15) (Adjustable 10 – 30, Steps ± 5)

This variable sets the time in seconds that the bonus round is active. Bonus Round Time is added to the Base Time if the play hits the required number of Villains.

■ VILLAINS HIT FOR BONUS

(Default 50) (Adjustable 20 – 100, Steps ± 5)

This variable sets the number of Villains that need to be hit to get to the bonus round.

■ MYSTERY BONUS AVERAGE

(Default 5) (Adjustable 1 – 9, Steps ± 1)

This variable sets the desired number of tickets the operator would like to average on the Mystery Bonus Round at the end of a game.

■ JACKPOT TICKETS

(Default 10) (Adjustable 1 – 20, Steps ± 1)

This variable sets the maximum number of Jackpot tickets that can be won on a Mystery Bonus Round at the end of a game.



■ TICKET PAYOUT

(Default ON) (Adjustable ON-OFF)

This setting turns the ticket payout **ON** or **OFF**. If sets to **ON**, the machine will payout tickets won by player. If sets to **OFF**, the machine will not dispense tickets.

■ ATTRACT MODE SOUNDS

(Default ON) (Adjustable ON-OFF)

This adjustment turns the *attract mode sounds* **ON** or **OFF**. This is the sound and music that the game generates to attract customers when it is not being played.

■ CALIBRATE X & CALIBRATE Y

(Displayed for Information Only)

This displays the X & Y off-set values stored in memory for the Gun Calibration. The display of “#” indicates an invalid value and calibration is required.

■ TICKET PAYOUT TABLE

(Adjustable 0 – 30,000, Steps ±50)

Default Values

No. of Tickets	Score
1	0
2	1500
3	3000
4	4500

No. of Tickets	Score
5	6000
6	7500
+1	3000

These variables set the number of score points required for tickets. The points needed from 1 to 6 tickets can be set individually for scalable payout. For more than 6 tickets, +1 is set to the number of extra points needed for each additional ticket above 6 tickets.

*** NOTE! ***

- It is recommended that Number of Tickets 1 to 6 have progressively increasing score values, or unpredictable ticket payout may occur.

AUDITS

- **ENTER** The Audits can be entered by highlighting **AUDITS** while in Test Mode main screen and pressing the white buttons. Or, by pressing the red Test button while in Attract mode once, highlighting **AUDITS**, and pressing the white buttons.
- **SELECT** The Service button is pressed to step between “Clear” and “Exit” dialog buttons repeatedly until the Audits is exited.
- **ACTIVATE** The two white buttons will activate the highlighted dialog button.
- **EXIT** The Audits is exited into Test Mode main screen by highlighting and pressing one of the white buttons on the “Exit” dialog button.



AUDITS SCREEN

User			
Num Coins [1] :	<input type="text" value="0"/>	Num Tickets [1] :	<input type="text" value="146"/>
Num Coins [2] :	<input type="text" value="19"/>	Num Tickets [2] :	<input type="text" value="0"/>
Num Services :	<input type="text" value="12"/>	Total Game Plays :	<input type="text" value="23"/>
		<input type="button" value="Clear"/>	<input type="button" value="Exit"/>

Machine			
Num Coins [1] :	<input type="text" value="0"/>	Num Tickets [1] :	<input type="text" value="146"/>
Num Coins [2] :	<input type="text" value="19"/>	Num Tickets [2] :	<input type="text" value="0"/>
		Total Game Plays :	<input type="text" value="23"/>

PARTS OF AUDITS SCREEN

■ USER

The User section enables the operator to see statistics for number of coins inserted, tickets dispensed, Service button pressed, and games played since the last game audits cleared. The statistics in this section can be cleared by highlighting the Clear dialog button, press one of the white buttons, and choose YES in the dialog box that appears.

*** NOTE! ***

- If an audit value in the User section reaches the value of 999,999, it will automatically stop increasing.

■ MACHINE

The Machine section displays total statistics for number of coins inserted, tickets dispensed, Service button pressed, and games played. The statistics in this section is the total number of statistics that were in the User section. Every statistics that were in the User section will be added to statistics in this section. Statistics in this section cannot be cleared.

*** NOTE! ***

- If an audit value in the Machine section reaches the value of 999,999, it will reset itself to 0.



AUDITS DETAILED

■ CLEAR

Highlighting the **CLEAR** dialog button, pressing either of the two white buttons, and choosing YES in dialog box appeared will clear the statistics in the User section.

■ EXIT

Highlighting the **EXIT** dialog button and pressing either of the two white buttons will exit the *Audits* and go back to Test Mode main screen.

■ NUM COINS [1]

This audit tells the number of coins inserted into coin mechanism 1. It is available in User and Machine section.

■ NUM COINS [2]

This tells the number of coins inserted into coin mechanism 2. This audit is available in User and Machine section.

■ NUM TICKETS [1]

This audit tells the number of tickets payout from ticket mechanism 1. It is available in User and Machine section.

■ NUM TICKETS [2]

This audit tells the number of tickets payout from ticket mechanism 2. It is available in User and Machine section.

■ NUM SERVICES

This tells how many times the Service button are pressed since the last game audits cleared. This audit is only available in the User section of the Audits.

■ TOTAL GAME PLAYS

This audit tells the number of games played. It is available in User and Machine section of the Audits.

SWITCH TEST

- **ENTER** The Switch Test can be entered by highlighting **SWITCH TEST** while in Test Mode main screen and pressing the white buttons. Or, by pressing the red Test button while in Attract mode once, highlighting **SWITCH TEST**, and pressing the white buttons.

■ TESTING GAME SWITCHES

To test the game switches, activate any of the game switches and see in the Switch Test screen whether the activated switch is ON or OFF. When ON the switch is active, if OFF the switch is not active.



■ **TICKET DISPENSER NOTCH**

The Ticket Notch Switch (C1) can be activated or deactivated from the Ticket Feed Button on the Ticket Dispenser PCB or by manually pushing the tickets from the ticket holder through the dispenser after pulling the ticket release rod upwards.

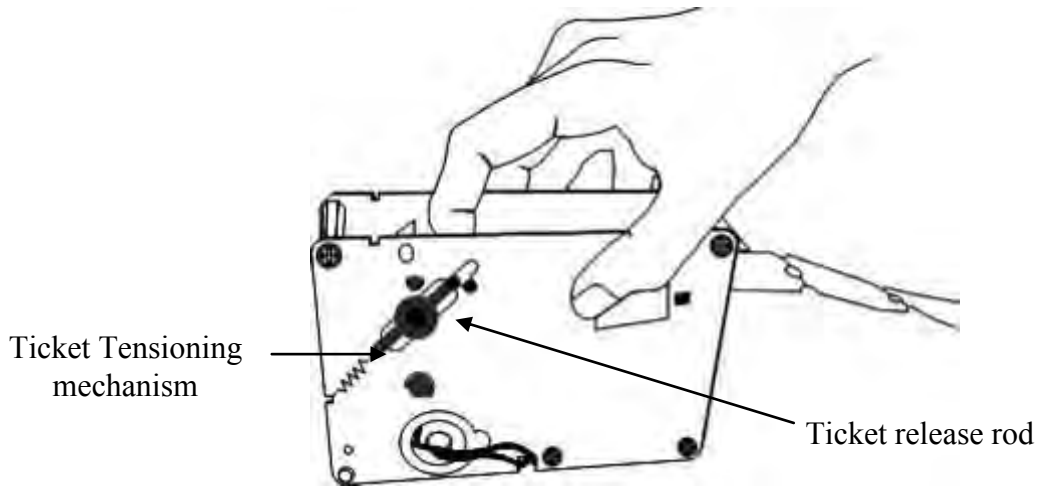

*** NOTE! ***

- For more information on the servicing and testing the ticket dispenser please look at the Dispenser Reference guide.

- **EXIT** The Switch Test is exited into Test Mode main screen by pressing the Service button once.

SWITCH TEST SCREEN

GUN X	0
GUN Y	0
GUN FIRE BUTTON	OFF
GUN CALIBRATION BUTTON	OFF
START BUTTON	OFF
TEST BUTTON	OFF
COIN1 BUTTON	OFF
COIN2 BUTTON	OFF
UP BUTTON	OFF
DOWN BUTTON	OFF
TICKET NOTCH	OFF



SCREEN TEST

- **ENTER** The Screen Test can be entered by highlighting **SCREEN TEST** while in Test Mode main screen and pressing the white buttons. Or, by pressing the red Test button while in Attract mode once, highlighting **SCREEN TEST**, and pressing the white buttons.
- **SELECT** The Service button is pressed to step through each of the Screen Test options available, starting from **Scale** stepping down through **Exit** and then looping again until the Screen Test is exited.
- **ENTERING OPTIONS SETTINGS**
One of the white Up and Down buttons is pressed to enter the chosen Screen Test option.
- **EXIT** The Screen Test is exited by highlighting the **Exit** using Service button and pressing one of the white buttons.

SCREEN TEST MAIN SCREEN

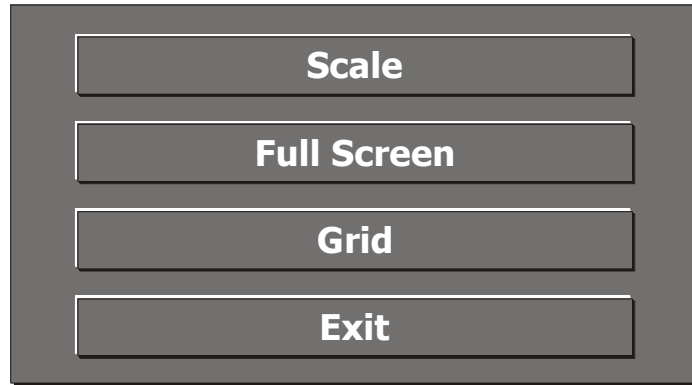

SCREEN TEST DETAILED

- **SCALE**
This option is used for adjusting the color balance of the screen monitor. To enter the color Scale display, highlight Scale in the Screen Test main screen and press one of the white buttons. The color Scale display is exited into Screen Test main screen by pressing Service button once.
- **FULL SCREEN**
Full Screen display is used for adjusting the color purity of the screen monitor. It is entered by highlighting Full Screen in the Screen Test main screen and pressing one of the white buttons. The Full Screen display is exited into Screen Test main screen by pressing Service button once.
- **GRID**
Grid is used for adjusting the screen geometric of the screen monitor. It is entered by highlighting Grid in the Screen Test main screen and pressing one of the white buttons. Grid is exited into Screen Test main screen by pressing Service button once.
- **EXIT**
Highlighting Exit and pressing one of the white buttons will exit the Screen Test main screen and go back to Test Mode main screen.



SOUND TEST

- **ENTER** The Sound Test can be entered by highlighting **SOUND TEST** while in Test Mode main screen and pressing the white buttons. Or, by pressing the red Test button while in Attract mode once, highlighting **SOUND TEST**, and pressing the white buttons.
- **SELECT** The Service button is pressed to step through each of the Sound Test options available, starting from **Left Channel** stepping down through **Exit** and then looping again until the Sound Test is exited.
- **ENTERING OPTIONS SETTINGS**
One of the white Up and Down buttons is pressed to enter the chosen Sound Test option.
- **EXIT** The Sound Test is exited by highlighting the **Exit** using Service button and pressing one of the white buttons.

SOUND TEST SCREEN

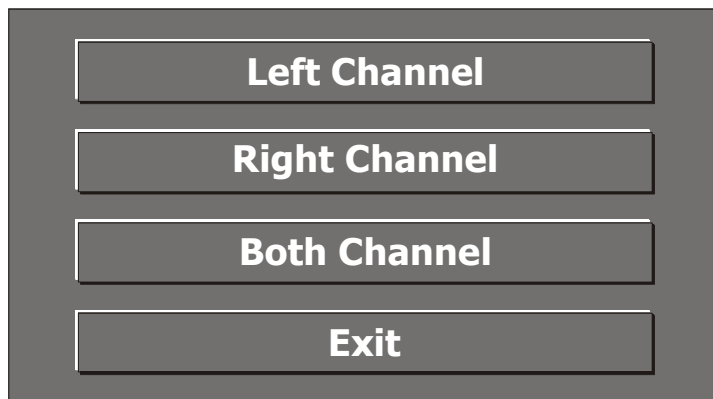

SOUND TEST DETAILED

- **LEFT CHANNEL**
This is for testing the left audio channel of the machine. When this option is chosen, sound will come out only from the left audio channel. To test the Left Channel, highlight Left Channel and press one of the white buttons while in Sound Test screen.
- **RIGHT CHANNEL**
This is for testing the right audio channel of the machine. When this option is chosen, sound will come out only from the right audio channel. To test the Right Channel, highlight Right Channel and press one of the white buttons while in Sound Test screen.
- **BOTH CHANNEL**
Both Channel is used to test both audio channels of the machine. When this option is chosen, sound will come out from both audio channels. Highlight Both Channel and press one of the white buttons while in Sound Test screen to test both audio channels.
- **EXIT**
Highlighting Exit and pressing one of the white buttons will exit the Sound Test screen and go back to Test Mode main screen.



ERRORS AND TROUBLESHOOTING

If the microprocessor detects any problems with the operation of the game, an Error will be displayed on the screen. There is one error message for Most Wanted, listed as follows:

ERROR DESCRIPTION	SOLUTION
TICKET ERROR Jammed tickets, no tickets or no ticket notch pulse for longer than 3 seconds.	Clear ticket/capsule dispenser jam or replenish tickets. After this, push Test button once to clear error.

TROUBLESHOOTING GAME ERRORS

■ CLEARING GAME ERRORS

Game errors can be cleared, by pushing the test button ONCE. The game will try and check if the error is fixed. If the reason for the error is fixed, the game will continue as normal. If the error is not fixed, the error will remain on the screen.

■ TICKET ERROR

This usually occurs if the game has run out of tickets or there is a ticket jam. A less common reason is if the game PCB tries to dispense tickets but doesn't get a notch pulse for approximately three seconds. Test the notch pulse by passing a ticket in and out of the notch sensor.

If the game was out of tickets, replace the tickets, clear the ticket jam and then push the test button once to clear the error. The game will then payout any owed tickets.



FUSE INFORMATION

*** WARNING! ***

*Always turn **OFF** Mains power and unplugged the game, before replacing any fuses.*

■ **MAIN AC SUPPLY FUSE (1 x 6 AMP FAST BLOW, M205 TYPE)**

This fuse is for the main AC supply and is situated in the IEC mains input socket.

*** NOTE! ***

- The power cord must be removed before the fuse can be accessed.

■ **MONITOR POWER FUSE (1 x 3 AMP FAST BLOW, M205 TYPE)**

This fuse is for the power supply on the 29" SVGA Monitor PCB.

*** CAUTION! ***

Do Not use any fuse that does not meet the specified rating.

FUSE LOCATION DIAGRAM

As viewed from rear

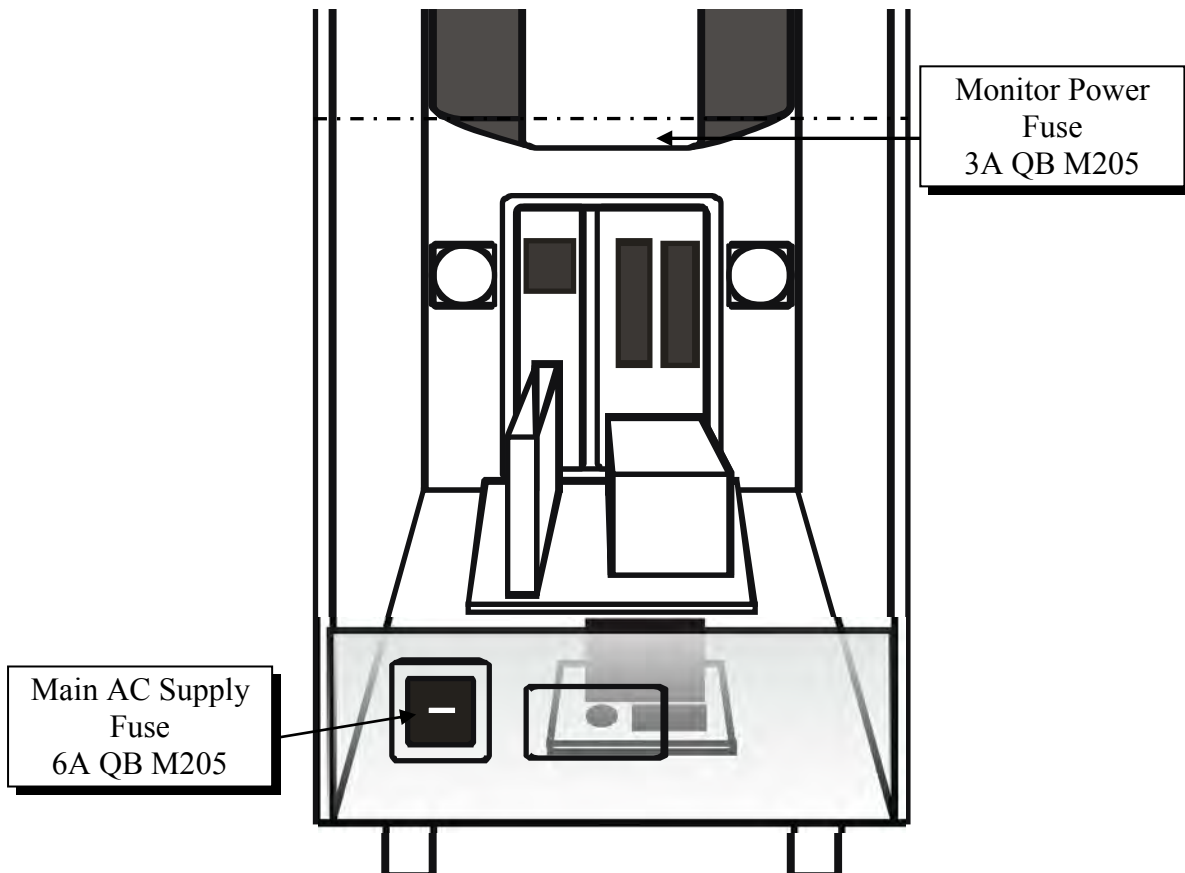



SECTION A: SERVICE INSTRUCTIONS

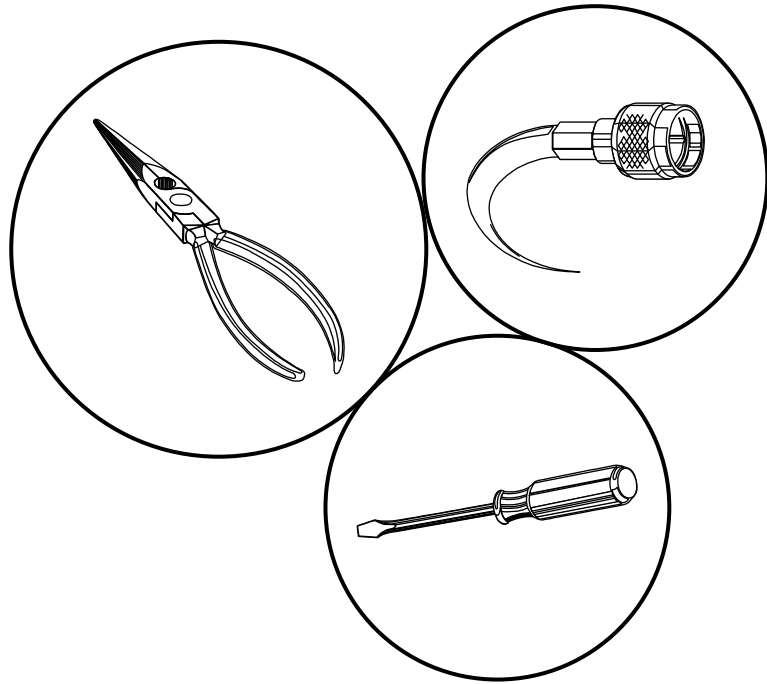

BE SURE TO READ THE FOLLOWING
Carefully before servicing this machine



A



LOCATING AND ACCESSING PARTS

PARTS LOCATION DIAGRAM

As viewed from front

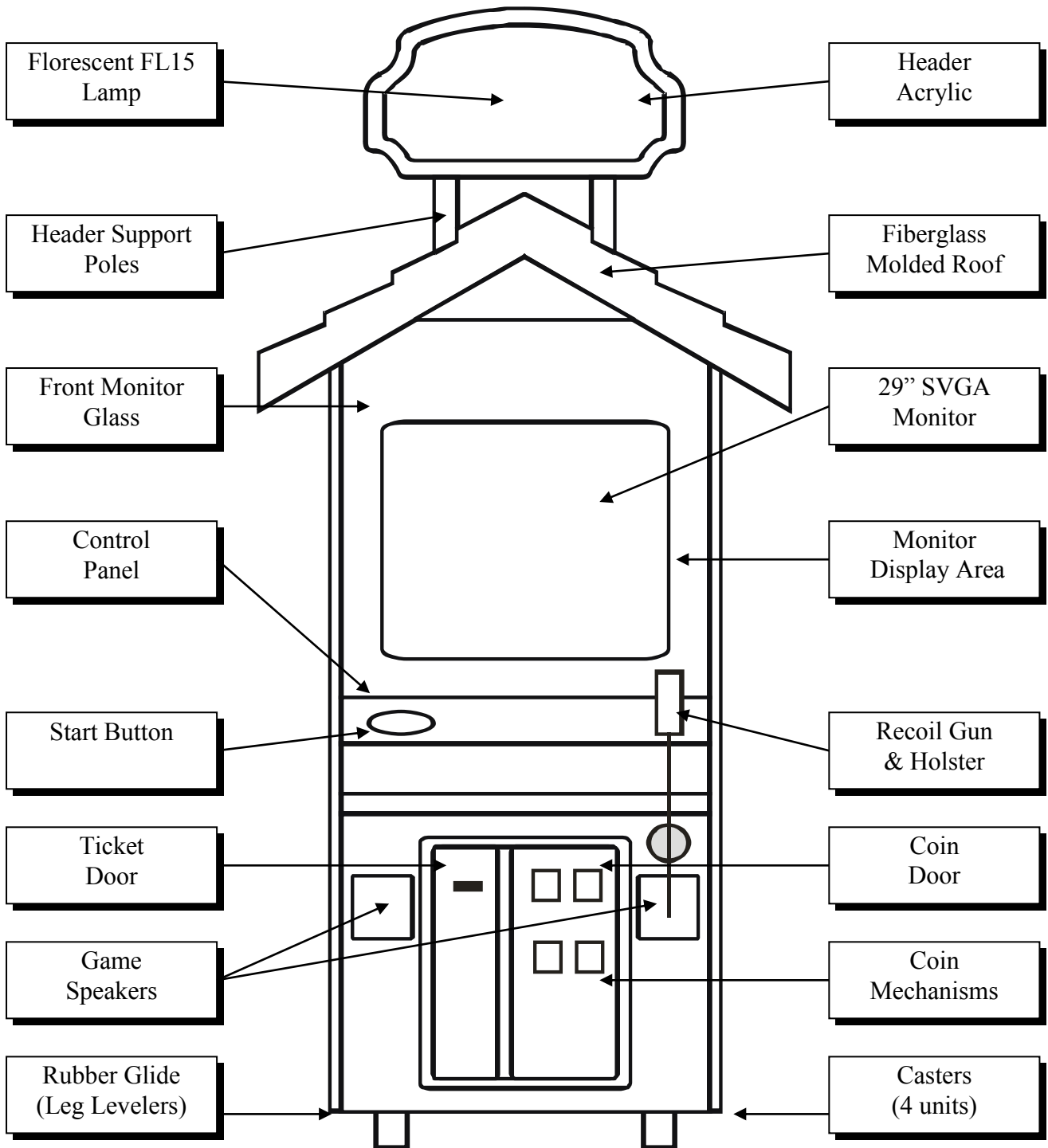



PARTS LOCATION DIAGRAM Cont.

As viewed from rear

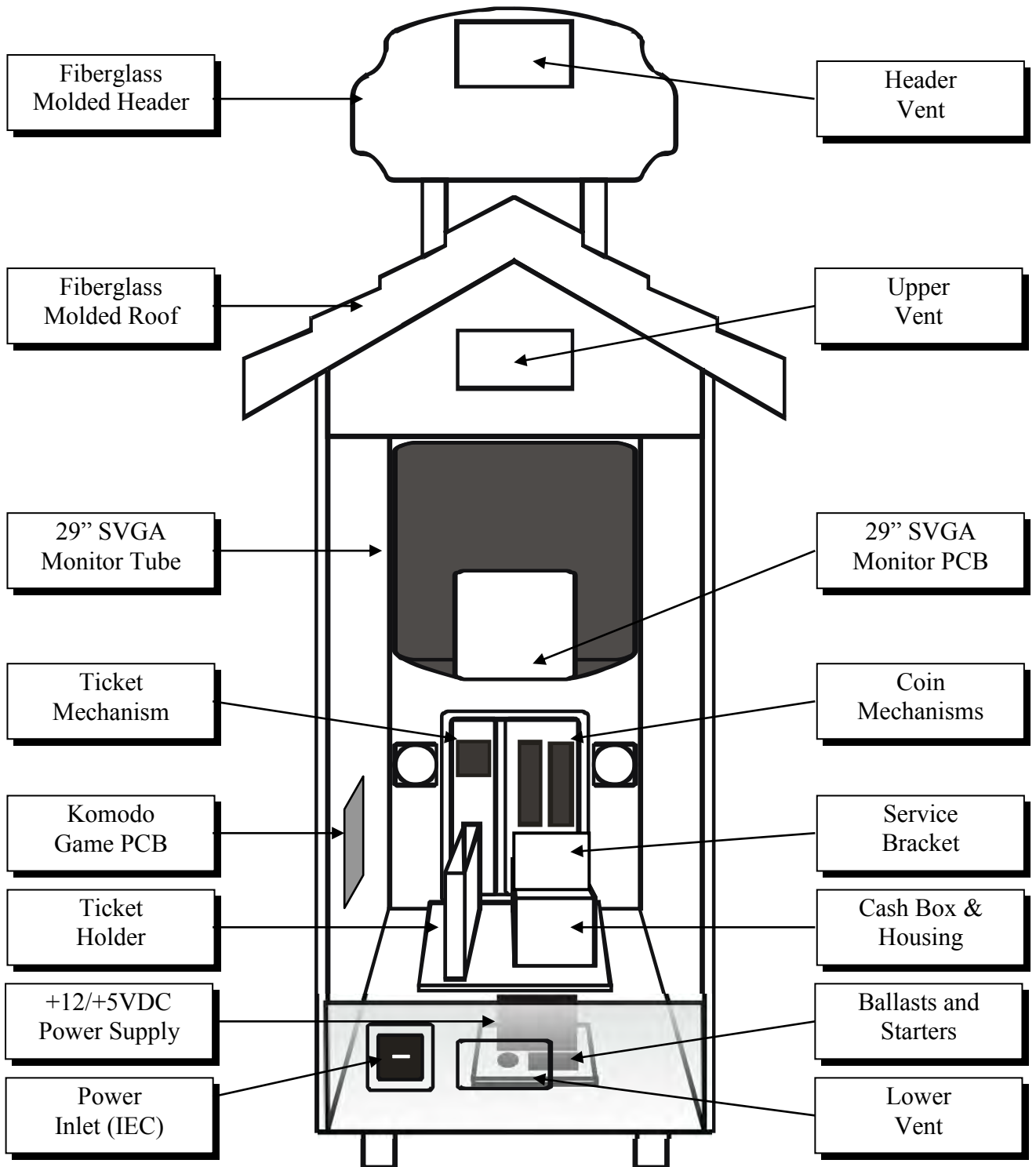

PARTS DESCRIPTION

■ COIN MECHANISMS

The coin mechanisms can be accessed inside the Coin door on the front of the machine cabinet.

■ CASH BOX

The cash box is located inside the coin door on the front of the machine cabinet.

■ TICKET MECHANISM

The ticket mechanism can be accessed inside the ticket door to the Right on the front of the machine cabinet.

■ SPEAKERS

Two speakers are located to the front of the cabinet below the control panel. Access is through the rear door.

■ SERVICE CONTROLS:

Located on the service panel mounted on top of the cash box and accessed through the Coin Door.

SERVICE BUTTON: Used to input credits to the game without activating the coin counter, and to perform adjustment procedures in combination with the test button

TEST BUTTON: Used to perform the adjustment mode, in combination with the Service button.

UP BUTTON: Used to increase values in the adjustment mode, in combination with the Service & Test buttons.

DOWN BUTTON: Used to decrease values in the adjustment mode, in combination with the Service & Test buttons.

GUN CALIBRATE BUTTON: Used to enter the Gun Calibration Mode in combination with the Recoil Gun.

VOLUME KNOB: Used to adjust the speaker's sound level.

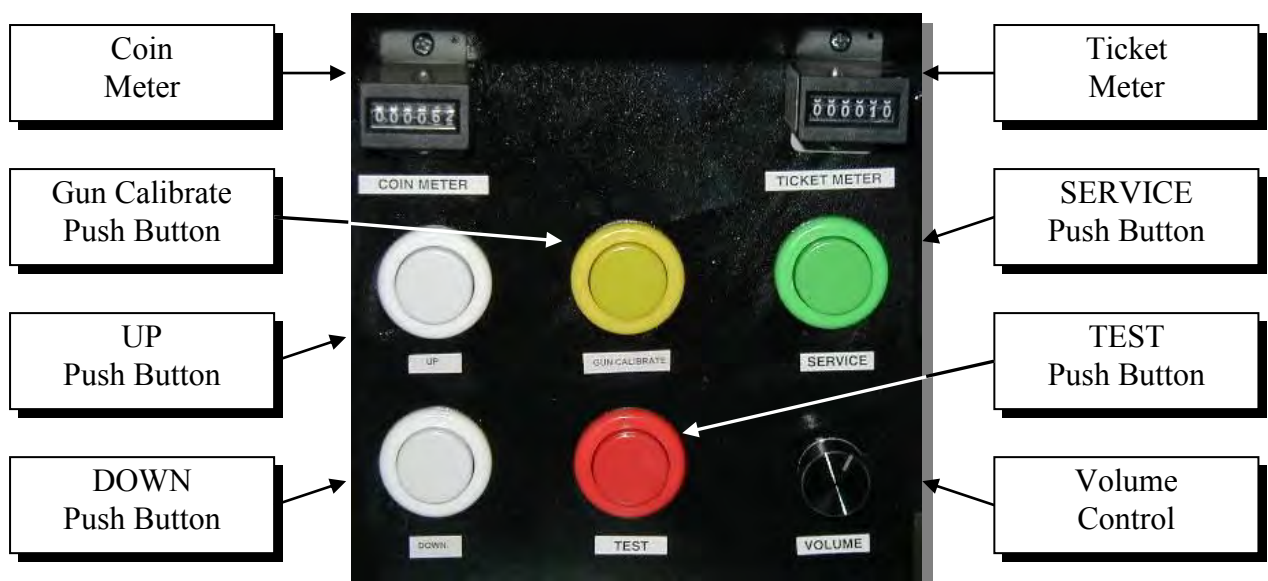



■ GAME CONTROLS:

Located in the center of the machine cabinet. The control panel can be Access through removing the six Allan head bolts on the control panel.

START BUTTON: The Start button is the large RED round illuminated button. This button is used to start a game.

RECOIL GUN: The recoil gun is located at the right-hand side of the control panel in a leather holster. The gun is used to shoot targets on the screen.

■ POWER CORD

The power cord is a standard IEC power cord (as used on computers) that is plugged in to the power inlet socket at the rear of the machine. The power cord can be removed for transport.

■ POWER INLET

The power inlet is located at the rear of the machine on the Left-hand side as viewed from the rear. It is a standard IEC inlet socket.

■ MAINS SWITCH

The mains switch is located on the power inlet assembly along with the mains fuse, and IEC inlet socket.

■ FUSES

For locations of all fuses refer to Fuses and Fuse location of this manual.

* WARNING! *

***Always** turn **OFF** Mains power and unplugged the game, before replacing any fuses*

***Always** use the correct rated fuse. Refer to page for fuse information.*

■ PCB's

For location of all game PCB's, refer to the Parts Location diagram page 23 of this manual.

■ POWER SUPPLY

The power supply is located at the back of the cabinet and is accessed from the rear of the machine. It is a multi voltage switching power supply.

■ BALLAST & STARTER

The header fluorescent ballast & starter is located at the back of the cabinet and is accessed from the rear of the machine. It is a 15W Ballast and F2 Starter.

■ 29" SVGA MONITOR

The 29" SVGA Monitor is located to the left at the back of the cabinet and is accessed from the rear of the machine.



LAMPS

*** WARNING! ***

***Always** turn **OFF** Mains power and unplugged the game, before replacing any lamps.*

***Always** allow time for cooling as Lamps that have been active for a time may still be too hot to touch.*

■ **COIN DOOR LAMPS**

The coin door lamps all are 12V/DC GE194 or equivalent and can be accessed through the coin door.

■ **BUTTON LAMP**

The button lamp is 12V/DC GE194 or equivalent and can be accessed through the coin door or back door.

■ **HEADER LAMP**

There is one standard FL 15 fluorescent tube for the Header Display. Access is by the removing of the machine header cover and accessing the tube from the front.

*** CAUTION! ***

***Always** replace the lamps with the same or equivalent size, wattage and voltage.*



MAINTENANCE

CLEANING AND CHECK UP

■ EXTERIOR

Regularly dust and clean the external cabinet areas as required, using a soft water-damp cloth and mild soap. Check for blown bulbs and replace as required.

Any scratches or marks in the fiberglass or acrylic can be buffed out using car polish or cut and polish.

*** CAUTION! ***

Do not use solvents on the panels as it may affect the artwork.

■ INTERIOR

Regularly dust and vacuum the interior of the cabinet, taking care to remove any objects that may have fallen on the PCBs. Check and tighten all fixing hardware and fasteners as required.

*** WARNING! ***

Always turn **OFF** Mains power and unplugged the game, before cleaning the interior of the machine.



Always after cleaning the cabinet interior, check all harness connectors and restore all loose or interrupted connections.

Regularly check that the Button Lamp is operating and the Gun accuracy is good. Replace the lamp if blown and calibrate the gun if necessary.

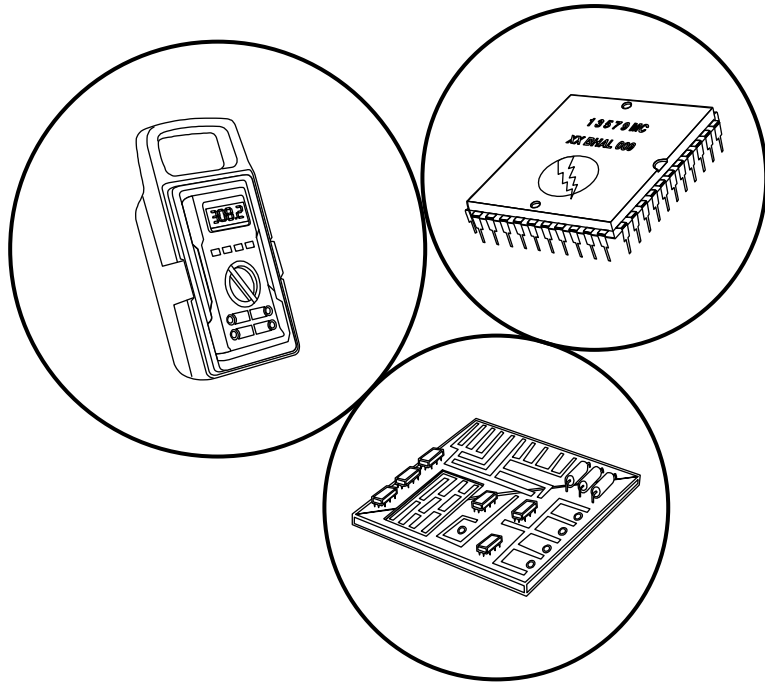

SECTION B: TECHNICAL DETAILS



 It is advised that anybody using SECTION B for repairing or modifying any of the components of the game should be a qualified technician, having at least a basic knowledge of digital components, integrated circuits and electricity. 



B



MAINS VOLTAGE ADJUSTMENT

■ POWER SUPPLY

The Switch Mode Power Supply has a switch to set the mains voltage range. It is located at the rear of the game cabinet, and is accessed via the back door. Use a thin blade screwdriver to move the selector switch to the desired mains voltage (See Diagram Below)

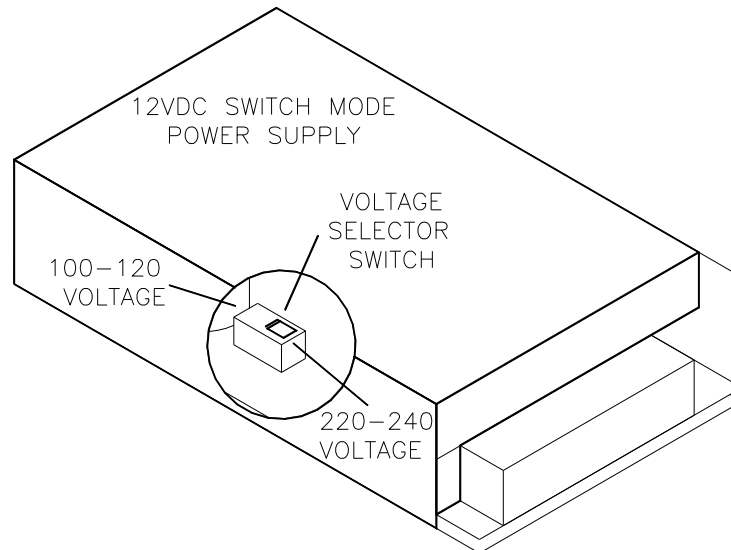

■ FLORESCENT TUBE BALLASTS AND STARTERS

Locate the florescent tube ballasts and starters in the back of the cabinet. If unsure of the location of any ballasts or starters, refer to Parts location diagram on page 23 of this manual. These have to be removed and replaced with an equivalent wattage at you local mains voltage level.

■ 29" SVGA MONITOR

The 29" SVGA Monitor is a "Voltage Free" type and can run on any AC source between 95VAC and 250VAC.



TICKET DISPENSER REFERENCE GUIDE

“Quick Release” Ticket Dispenser Manual

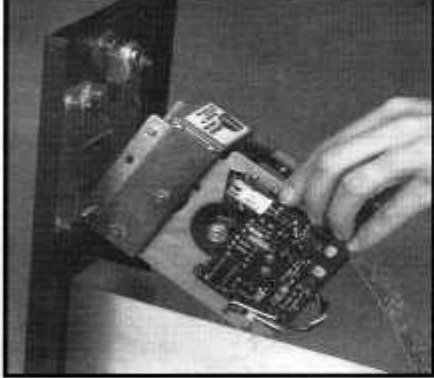

U.S. Patent 5833104
Additional Patents Pending

The “Quick Release” Ticket Dispenser

- Quick release face plate
- Bottom metal ticket guide
- Foolproof braking system
- Optical sensor dust cover

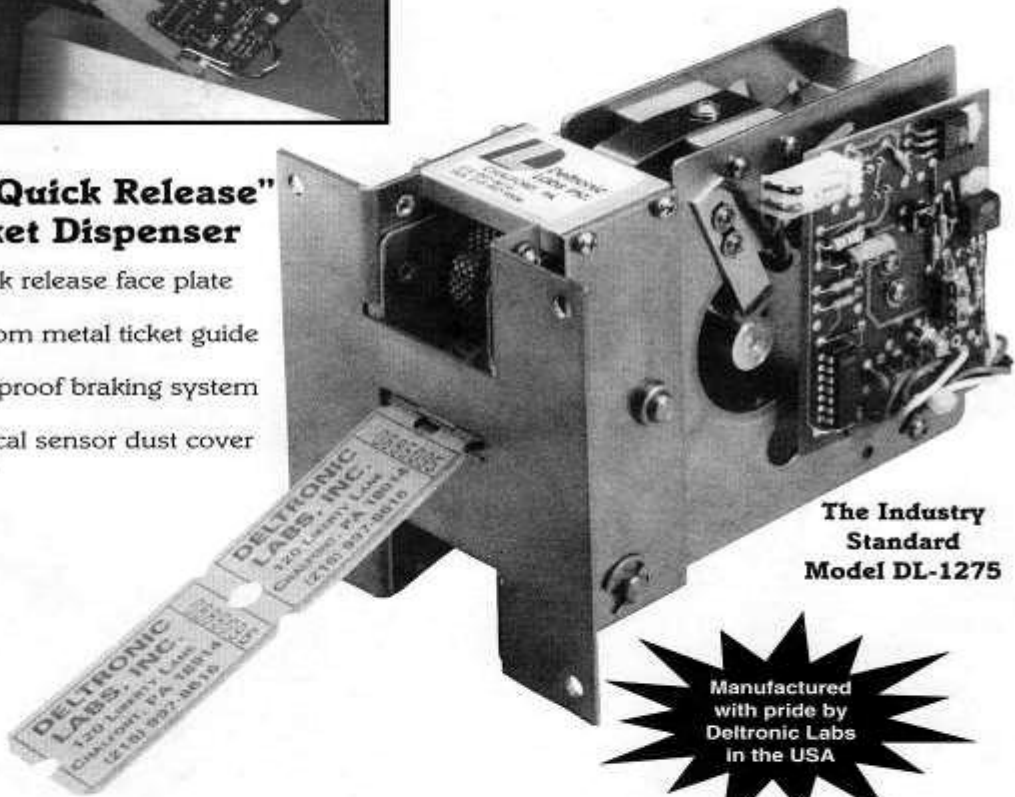

The Industry
Standard
Model DL-1275



**Another quality product from Deltronic Labs . . .
the industry leader in ticket dispensers.**



Deltronic Labs, Inc. 120 Liberty Lane, Chalfont, PA 18914
215-997-8616 • FAX# 215-997-9506 • Web Site: www.deltroniclabs.com

“Quick Release” Ticket Dispenser

Features

All Models

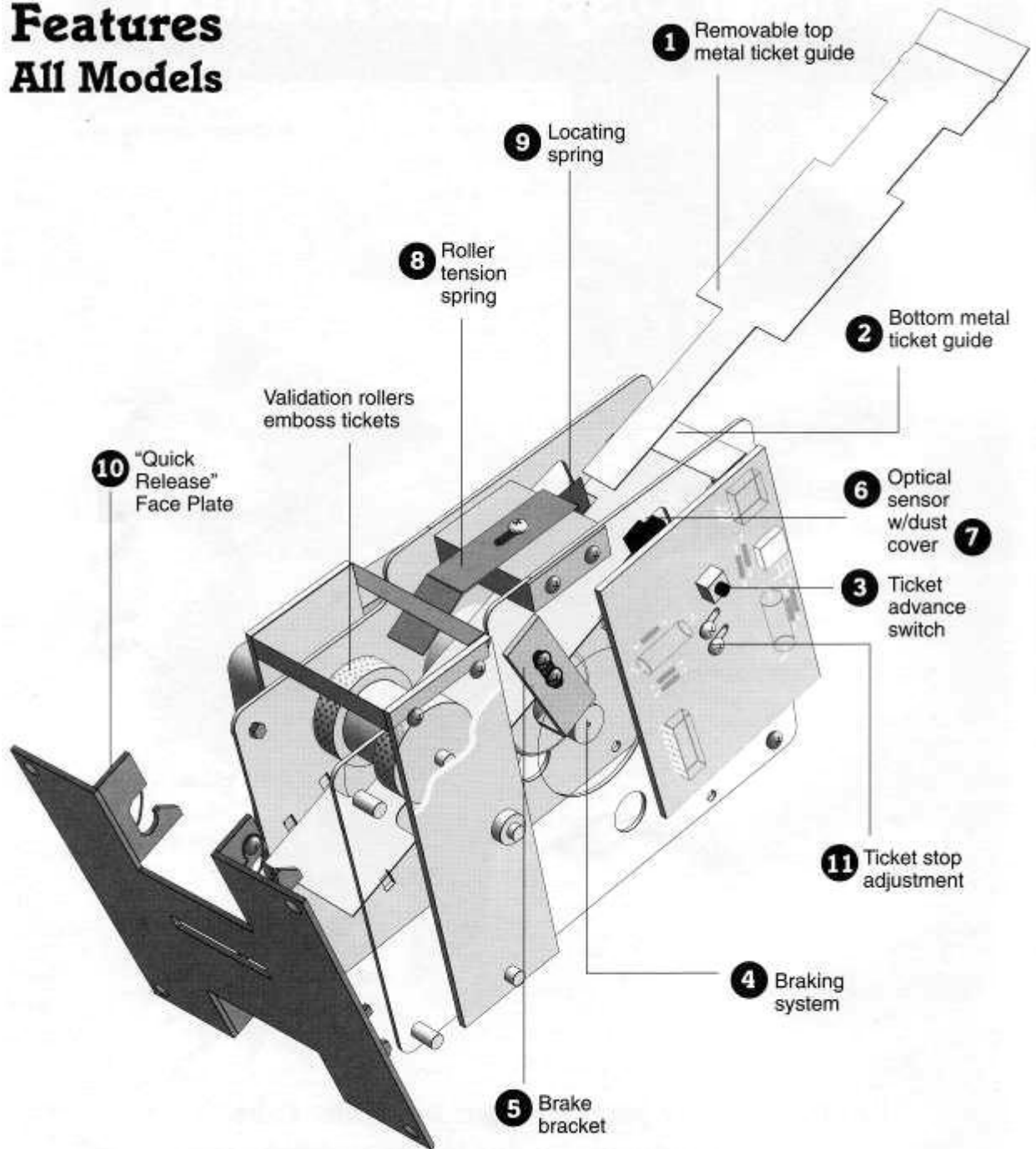

Deltronic Labs, Inc. 120 Liberty Lane, Chalfont, PA 18914 • 215-997-8616 • FAX# 215-997-9506 • www.deltroniclabs.com

Ticket Dispenser Assembly

Details of Parts			
F/N	Qty	Deltronic Labs P/N	Name
11	1	SHFT-IDLRLR/TD/	IDL. ROLLER SHAFT
12	1	RM-SFTMTR/TD/	MOTOR PIVOT SHAFT
13	1	SPAC PIVBLK/TD/HOL	PIVOT BRACKET SPAC
14	1	RM-SPCPB/TD/	SPACER BLOCK
15	2	RM-PLRDL/TD/VALD	IDLER ROLLER
16	1	RM-PLRDRV/TD/VALD	DRIVE ROLLER
17	2	SPRG-TENSN/TD/	TENSION SPRING
18	2	RM-BKTPVT/TD/	MTR PIVOT BKT
19	1	RM-FRNLFT/TD/NCFM	FRONT PANEL
20	1	RM-WHLBPK/TD/	BRAKE WHEEL
21	1	SPRG-LOCAT/TD/	LOCATING SPRING
22	1	RM-BKTBRK/TD/	BRAKE BRACKET
23	1	RM-BKTUB/TD/3/8	URETHANE BRAKE
24	1	PCBD-1275/TD/+	PC BOARD
25	1	RM-MOTOR/TD/	MOTOR
26	2	RM-PLATFR/TD/	FRAME PLATE
27	1	RM-CONN2PTE/20G	2-PIN FEMALE CONN.
28	4	BRNG-F312/TD/BRASS	BUSHING
29	1	SPAC-PCBD/TD/	P.C. BOARD SPACER
30	1	SPAC-HEX/TD/1-1/4	HEX SPACER 1-1/4"
31	1	RM-1M/TD/50V	JMFD 50V
32	1	SPAC-HEX/TD/1/4"	STAND OFF
33	1	GUID-BOTTOM/TD/MET	LOWER GUIDE MET.
34	4	RING-E25R/TD/	RETAINING RING
35	1	GUID-TOP/TD/MET	TOP GUIDE METAL
36	2	PULY-SP212/TD/NYLN **	SPACER WASHER
37	2	SPRG-FRONT/TD/	SPRING FRONT-PLATE
38	4	RM-PEMNU/TD/FRPL	PEWNUIT FRAME
39	2	RM-PEMNU/TD/FRPN	PEWNUIT FRONT
40	1	COVR-H21A/TD/OPTO	DUST COVER
41	1	CONN-MOLEX/TD/4PM	4 WIRE MOLEX MA.
42	1	RM-LABEL/TD/ALUM.	LABEL ALUMINUM
43	1	WIRE-REDBLK/TD/MOTOR	
44	2	SPAC-PVBRK/TD/HEX+***	SPACER 1/4" HEX.

* Order by Model #

** Note: F/N #36 replaces .032 and .093 spacer washers.

*** Note: F/N #44 replaces large spacer block.

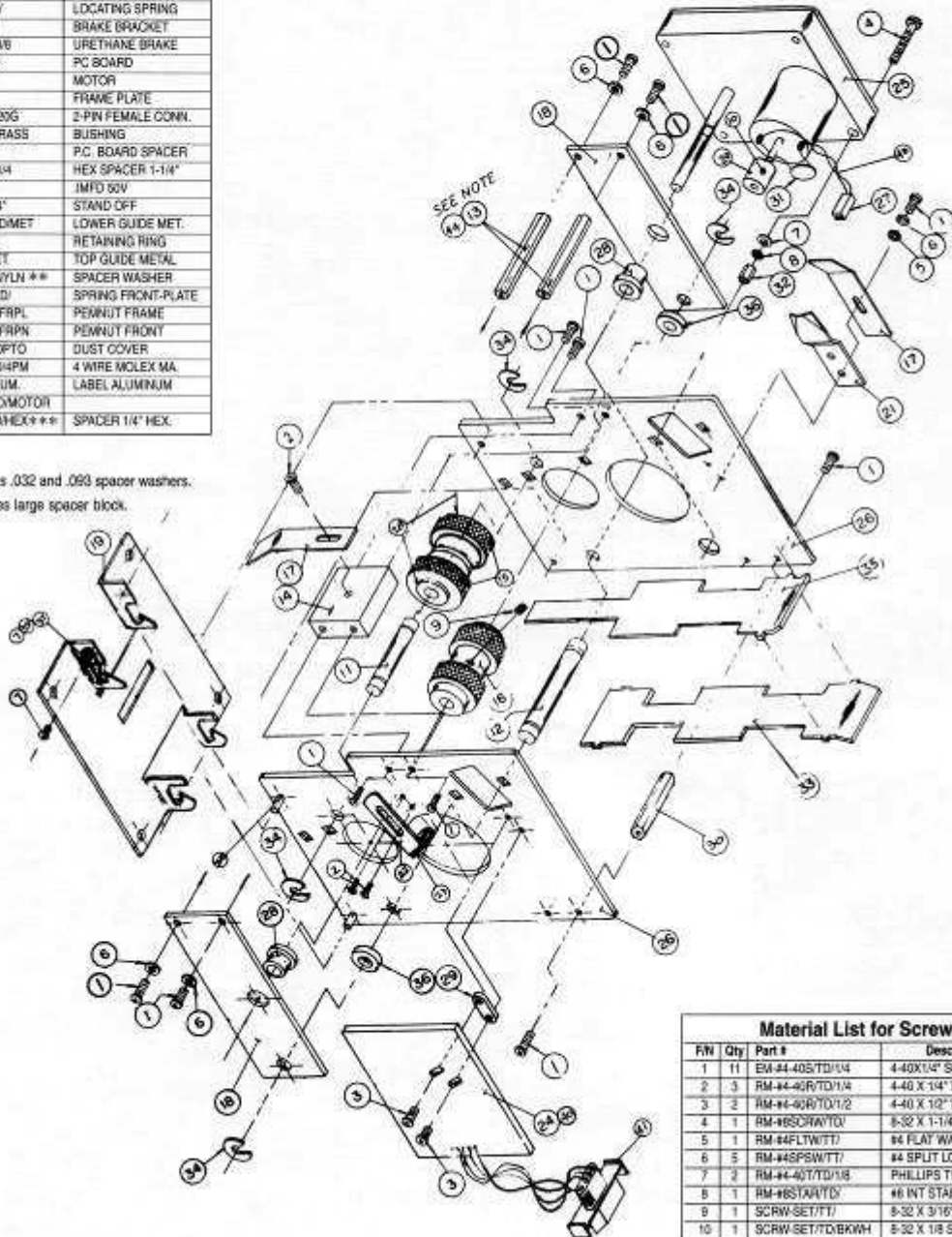

Material List for Screws			
F/N	Qty	Part #	Description
1	11	EM-#4-40S/TD/1/4	4-40X1/4" SCREW
2	3	RM-#4-40R/TD/1/4	4-40 X 1/4" WASHER HEAD
3	2	RM-#4-40R/TD/1/2	4-40 X 1/2" WASHER HEAD
4	1	RM-#6SCRW/TD/	6-32 X 1-1/4"
5	1	RM-#4FLTW/TD/	#4 FLAT WASHER
6	5	RM-#4SPSW/TD/	#4 SPLIT LOC. WASHER
7	2	RM-#4-40T/TD/1/8	PHILLIPS TRUSSHEAD
8	1	RM-#6STAR/TD/	#6 INT STAR WASHER
9	1	SCRW-SET/TD/	6-32 X 3/16" SET SCREW
10	1	SCRW-SET/TD/BKWH	6-32 X 1/8 SET SCREW

Deltronic Labs, Inc. 120 Liberty Lane, Chalfont, PA 18914 • 215-997-8616 • FAX# 215-997-9506 • www.deltroniclabs.com



Control Board Rev. 8

DL-1275 with 12V meter output

This dispenser is controlled by the game software. The game turns on the dispenser with a logic high signal and monitors a return notch signal from the ticket dispenser to turn it off. It will dispense as many tickets as game options allow.

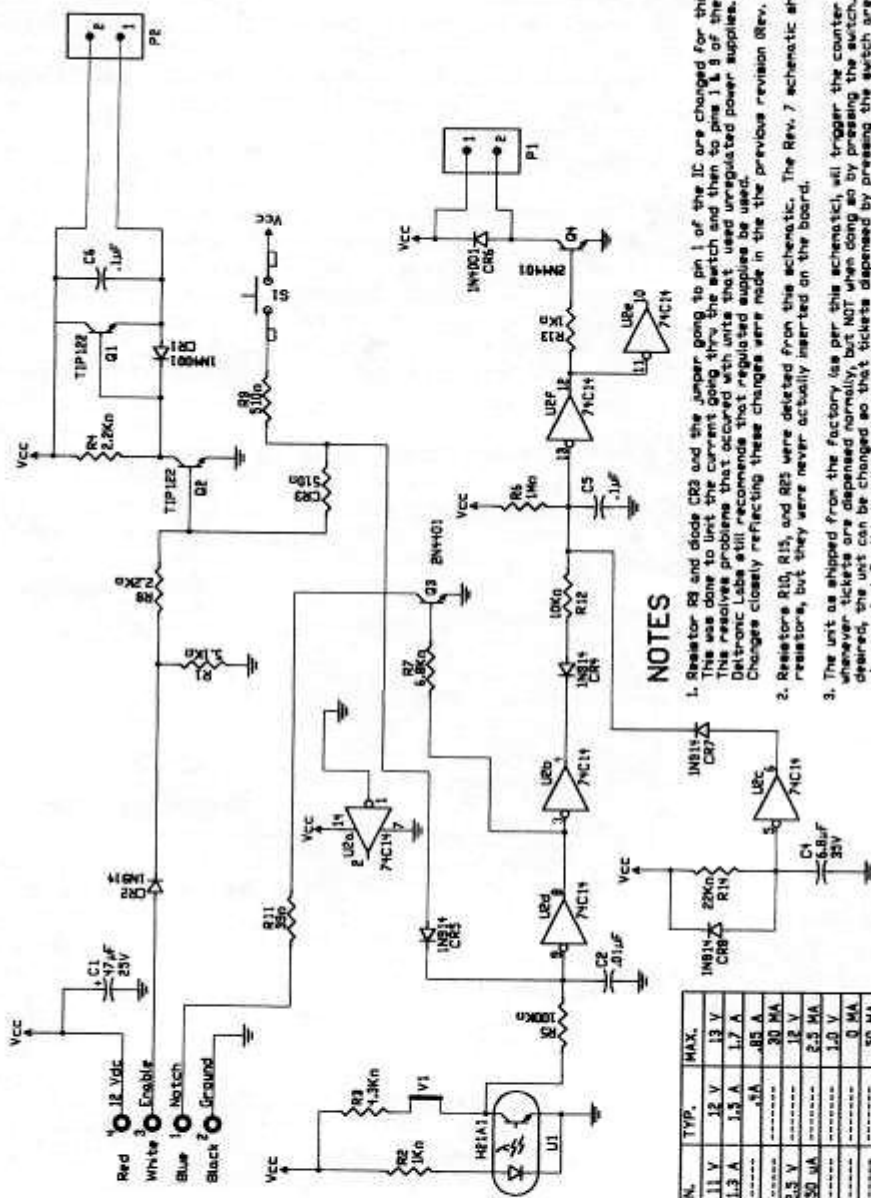

NOTES

1. Resistor R9 and diode CR3 and the jumper going to pin 1 of the IC are changed for this revision. This was done to limit the current going thru the switch and then to pins 1 & 8 of the IC. This resolves problems that occurred with units that used unregulated power supplies. Deltronic Labs still recommends that regulated supplies be used. Changes closely reflecting these changes were made in the previous revision (Rev. 7).
2. Resistors R10, R15, and R25 were deleted from the schematic. The Rev. 7 schematic shows these resistors, but they were never actually inserted on the board.
3. The unit as shipped from the factory (as per this schematic), will trigger the counter whenever tickets are dispensed normally, but NOT when done so by pressing the switch. If desired, the unit can be changed so that tickets dispensed by pressing the switch are also counted. Do this by deleting diode CR5.
4. This unit can be made to conform to CE specifications by the addition of 4 components not shown here. If this is desired, please order the CE version, and the unit will be shipped with the necessary components.
5. The unit can be configured in a number of ways. Please check our "Full Options" schematic to see the different configurations. If this schematic is not included with your manual, contact us for a copy.
6. If tickets are highly translucent, the 1.2Kohm resistor (R2) can be lowered in value (e.g. 2.2 Kohm). For more sensitive adjustment, the Jumper V1 can be replaced with a 2K pot, and the 1.2 Kohm resistor (R2) changed to 1Kohm.

MIN.	TYP.	MAX.
11 V	12 V	13 V
1.2 A	1.5 A	1.7 A
0.1A	0.5 A	0.5 A
2.5 V	---	12 V
250 uA	---	2.5 MA
---	---	0 MA
---	---	50 MA
---	---	30 V

MOTOR SUPPLY - V ---
I (START) ---
I (RUN) ---
I (STANDBY) ---
MOTOR ENABLE ON - V ---
MOTOR ENABLE OFF - V ---
TICKET NOTCH - I SINK ---
V PULL UP ---

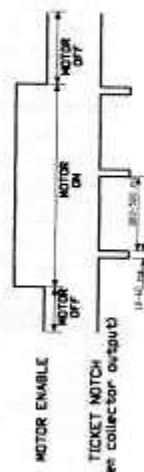

Control Board

Models DL-4-S-S DL-4-P-S

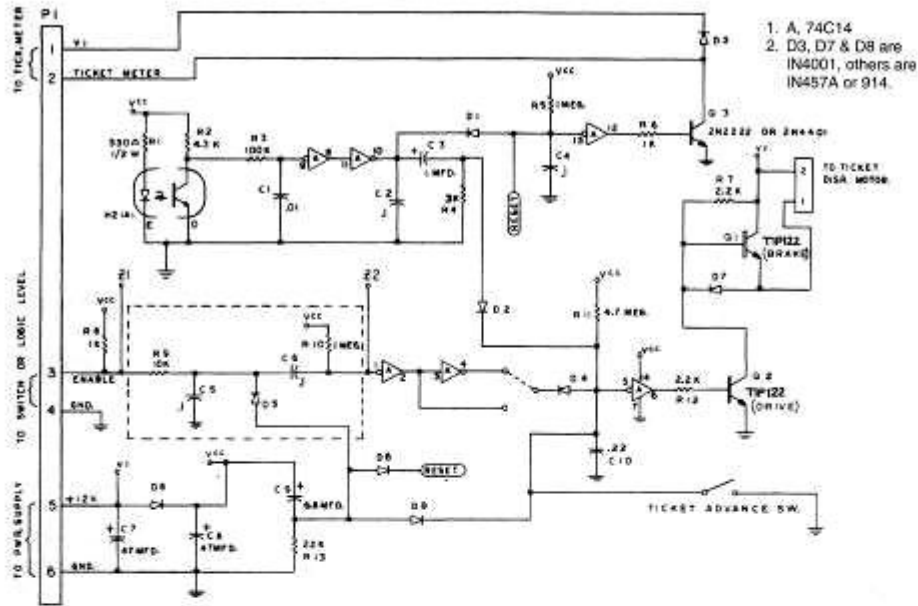

1. A, 74C14
2. D3, D7 & D8 are IN4001, others are IN457A or 914.

Model #DL-4-S-S, SW Input
Model #DL-4-P-S, Logic Input.

Note: With logic input components and dotted lines are omitted and Z1 is jumpered to Z2.

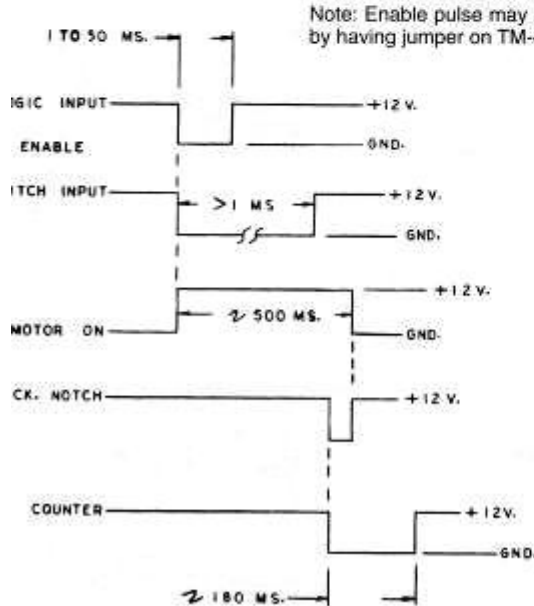

Note: Enable pulse may be positive or negative by having jumper on TM-4 in proper place.

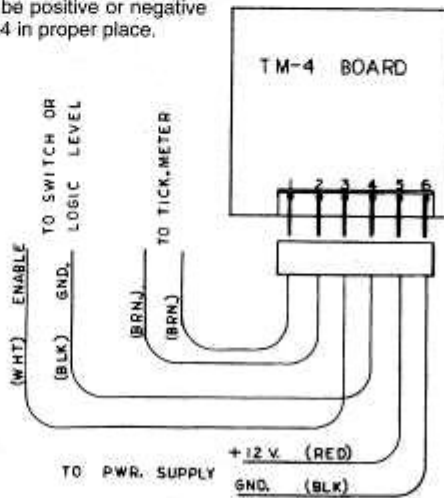

Note: On PCB TM-4, Rev. 1 & 2, Q1 and Q2 transistors are D40K1 or equivalent.

Model #DL-4-S-S
Model #DL-4-P-S



MOST WANTED JAMMA & CONNECTOR LIST

SOLDER SIDE	JAMMA	1	PARTS SIDE
GND	A	1	GND
GND	B	2	GND
+5V	C	3	+5V
+5V	D	4	+5V
	E	5	
+12V	F	6	+12V
POLARIZING KEY	H	7	POLARIZING KEY
	J	8	TICKET DRIVE
	K	9	START LAMP
SPEAKER +R	L	10	SPEAKER –R
SPEAKER +L	M	11	SPEAKER –L
(NC) GREEN*	N	12	(NC) RED*
(NC) SYNC*	P	13	(NC) BLUE*
SERVICE	R	14	(NC) VIDEO GND*
	S	15	TEST
COIN SWITCH 2	T	16	COIN SWITCH 1
TRIGGER SWITCH	U	17	START SWITCH
	V	18	UP SWITCH
DOWN SWITCH	W	19	
	X	20	
CALIBRATE SWITCH	Y	21	
	A	22	
	a	23	
	b	24	TICKET NOTCH
COIN COUNTER	c	25	TICKET COUNTER
	d	26	
GND	e	27	GND
GND	f	28	GND

ULN DRIVER	
1	RECOIL SOLENOID*
2	RECOIL SOLENOID*
3	RECOIL SOLENOID*
4	RECOIL SOLENOID*
5	(NC)
6	(NC)
7	(NC)
8	(NC)
9	(NC)

*Note: Solenoid Drivers all
Wired in Parallel

EXTERNAL VOLUME	
1	AUDIO RETURN 1
2	AUDIO OUT 1
3	AUDIO RETURN 2
4	AUDIO OUT 2
5	AUDIO GND (SHIELD)

Note: Set onboard volume to
Minimum levels when
Using external controls

GUN CONNECTOR	
1	OPTICAL INPUT
2	+5VDC
3	(NC)
4	(NC)
5	LOGIC GND

*Note: JAMMA Video Outputs used for CGA Games only.
Use the 15pin Monitor Plug for Most Wanted (VGA)

*** NOTE! ***

- Polarity Key is to prevent accidental reverse insertion of edge connector
- Check and adjust the +5VDC that it is between 4.8 and 5.1 Volts at the edge connector.



3D EXPLODE PARTS

NO	PART NO.	DESCRIPTION	QTY
01	HM5509	FIBER GLASS MOLDING FOR FD	1 SET
01A	E03434	LAMP NEON END CAP HOLDER	2
02	E02835	LAMP NEON 15W COOL WHITE	1
02A	E04034	LAMP NEON WITH END CAP	2
03	MH-FM-009-R1	NAME POST BOARD	2
04	AT3235	ACRYLIC HEADER	1
05	MZ2309	STICKER AESTHIC MOST WANTED TOP HEADER PC	1
06	MH-FM-03A-R0	FIBER GLASS MOLDING FOR FD	1 SET
06A	AT3231	SIDE WALL WITH STICKER	1R,1L
07	EC3828	STICKER MOST WANTED SIDE RIGHT PC	1
08	EC3828	STICKER MOST WANTED SIDE LEFT PC	1
09	BP5119	CABLE VGA DB 15W MALE 1.5 MTR	1
09A	MH-FM-005	PCB PANEL NAME BOARD CONTROLLER	1
10	MH-FM-005	RECORDER ASSEMBLY	1
10A	MH-FM-005	RECORDER LEATHER WITH BRACKET	1
10B	MH-FM-005	RECORDER MOUNTS 3P-X 7/N/A 101	1
11	MH-FM-005-R0	MONITOR MOUNTED MASK MONITOR COVER PC	1
11A	AT3236	MONITOR MOUNTED MASK MONITOR COVER PC	1
12	MH-FM-001-R0	SAFETY CLASS MIRROR	1
13	E41059	COLOUR PICTURE TUBE 29"	1
14	MH-FM-002	TICKET DOOR ASSEMBLY	1 SET
14A	MH-FM-19-19-R0	TICKET DOOR METAL ONLY	1
14B	E41102	LOCK DOOR	1
14C	MH-FM-002	LOCK DOOR WITH ENTRY	1
14D	AT3233	STICKER MOST WANTED FRONT CABINET PC	1
14E	MH-FM-19-19-R0	TICKET DOOR HINT	1
15	MH-FM-002	TICKET DOOR HARNESS	1
15A	E40621	CORRIDOR DOUBLE SLOT ASSY	1 SET
15B	E40622	SWITCH SMALL ROUND WHITE BUTTON	1
15C	E40623	SWITCH SMALL ROUND YELLOW BUTTON	2
15D	MH-FM-01-R0	CON DOOR	1
15E	MH-FM-20-20-R0	CORRIDOR DOUBLE SLOT METAL ONLY	1
15F	MH-FM-002	LOCKING COVER	1
15G	AT3233	STICKER MOST WANTED FRONT CABINET PC	1
15H	MH-FM-002b	CORRIDOR DOUBLE SLOT HARNESS	1
16	MH-FM-01-R0	CON DOOR DBA 1 SLOT HARNESS	1
16A	MH-FM-07A-R1	CON DOOR ASSEMBLY	1
17	MH-FM-07A-R1	WALL FOOT WITH STICKER	1
18	MH-FM-012-R0	STICKER MOST WANTED FRONT CABINET PC	2
19	E41276	SPEAKER 2" LOW BOSTON 1023-MW	2
20	HM0010	RUBBER MACHINE COUSE	4
21	MH-FM-001	CASH BOX MOUNTING CASH BOX	1 SET
22	MH-FM-21-21-R1	SERVICE PANEL ASSEMBLY ONLY	1
22A	E40519	SWITCH SMALL ROUND RED BUTTON	1
22B	E40520	SWITCH SMALL ROUND GREEN BUTTON	1
22C	E40521	SWITCH SMALL ROUND BLUE BUTTON	1
22D	E40522	SWITCH SMALL ROUND YELLOW BUTTON	1
22E	E40523	CONSOLE MOUNTING	1
22F	E40524	FRONT MOUNTING	1
22G	E40525	FRONT MOUNTING	1
22H	E40526	FRONT MOUNTING	1
22I	E40527	FRONT MOUNTING	1
22J	E40528	FRONT MOUNTING	1
22K	E40529	FRONT MOUNTING	1
22L	E40530	FRONT MOUNTING	1
22M	E40531	FRONT MOUNTING	1
22N	E40532	FRONT MOUNTING	1
22O	E40533	FRONT MOUNTING	1
22P	E40534	FRONT MOUNTING	1
22Q	E40535	FRONT MOUNTING	1
22R	E40536	FRONT MOUNTING	1
22S	E40537	FRONT MOUNTING	1
22T	E40538	FRONT MOUNTING	1
22U	E40539	FRONT MOUNTING	1
22V	E40540	FRONT MOUNTING	1
22W	E40541	FRONT MOUNTING	1
22X	E40542	FRONT MOUNTING	1
22Y	E40543	FRONT MOUNTING	1
22Z	E40544	FRONT MOUNTING	1
23	E40545	FRONT MOUNTING	1
24	E40546	FRONT MOUNTING	1
25	MH-FM-005-R0	MONITOR BRACKET LOWER	1
26	MH-FM-005-R0	MONITOR BRACKET UPPER	1
27	MH-FM-001-R0	BACK DOOR	1
28	MH-FM-005-R0	MONITOR BRACKET UPPER	1
29	MH-FM-005-R0	MONITOR BRACKET UPPER	1
30	MH-FM-005-R0	MONITOR BRACKET UPPER	1

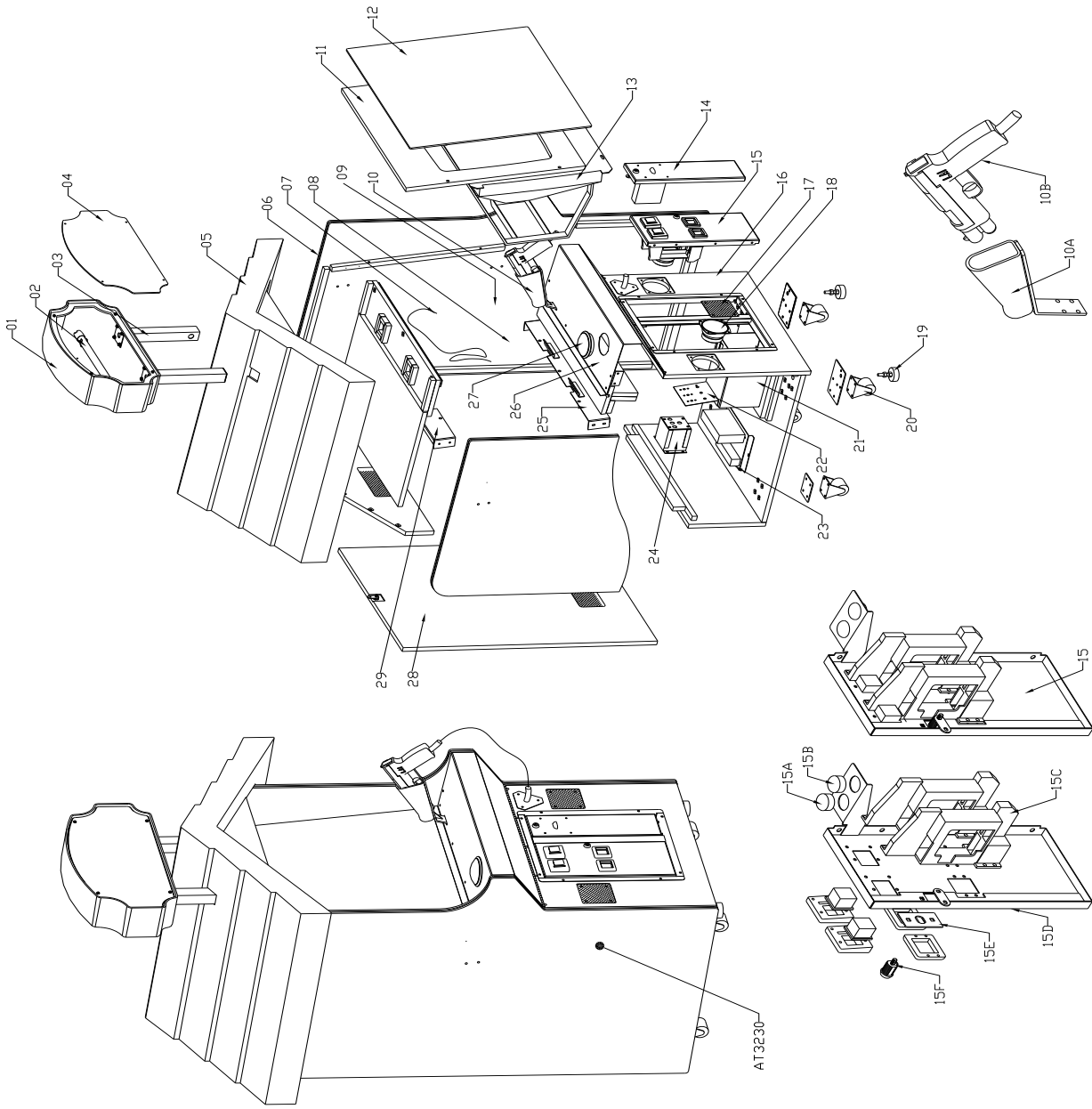



MOST WANTED WIRING DIAGRAM

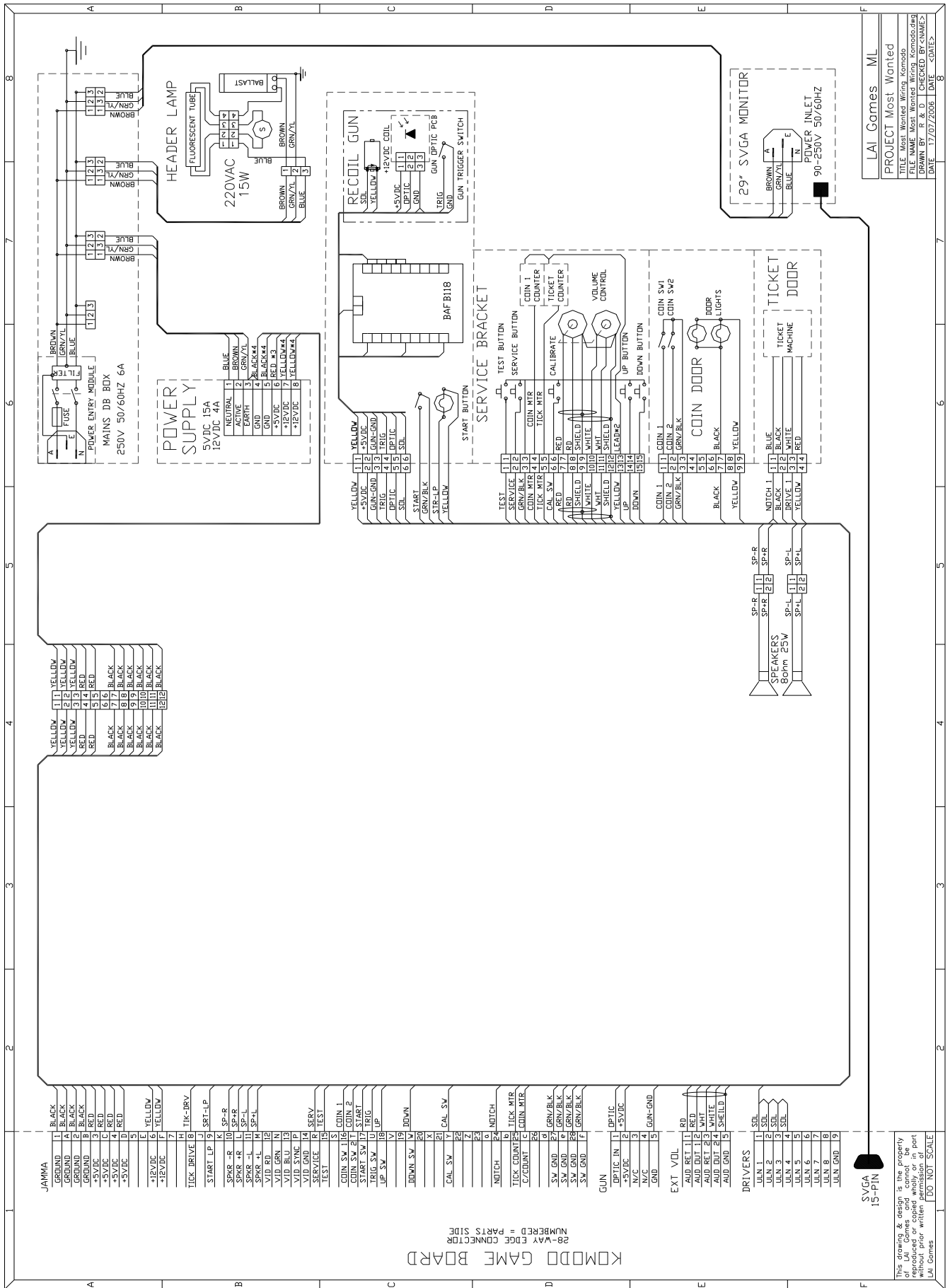



DISCLAIMER

OPERATOR WILL TAKE NOTE.

BY ACCEPTING DELIVERY OF AND PLACING THIS HARDWARE AND LICENSED SOFTWARE INTO OPERATION, OPERATOR REPRESENTS AND WARRANTS THAT IT WILL ONLY OPERATE THE HARDWARE AND LICENSED SOFTWARE PROVIDED BY LAI GAMES IN COMPLIANCE WITH THE REGULATORY REQUIREMENTS OF THE COUNTRY, STATE, AND/OR MUNICIPALITY IN WHICH THE HARDWARE AND LICENSED SOFTWARE ARE USED AND/OR OPERATED. LAI GAMES HAS PROVIDED THIS HARDWARE AND LICENSED THE SOFTWARE **ONLY** FOR LEGITIMATE AND LEGAL USE, AND ANY USE OF THE HARDWARE AND LICENSED SOFTWARE IN A MANNER THAT VIOLATES ANY LAWS OF THE COUNTRY, STATE, AND/OR MUNICIPALITY IN WHICH THE HARDWARE AND LICENSED SOFTWARE ARE USED AND/OR OPERATED IS WHOLLY UNAUTHORIZED AND SHALL BE AT OPERATOR'S SOLE AND COMPLETE RISK.

Operator assumes any and all risk and liability for any civil or criminal legal claims or causes of action arising from the unauthorized use and/or operation of the provided hardware and licensed software, such improper and unauthorized use specifically including, but not limited to:

- (a) Operating or allowing the operation of the hardware and licensed software in a manner that violates the laws and regulations of the country, state, and/or municipality in which the hardware and licensed software are used or operated;
- (b) Assembling or causing the assembly of the hardware in a manner not authorized by or disclosed in this manual;
- (c) Any tampering with, changes to, or modifications of the licensed software that occur after the software leaves LAI GAMES' factory that is not made by authorized LAI GAMES personnel and that is directly or indirectly caused by Operator; and
- (d) Any tampering with the computer chip/electronic programmable read only memory (EPROM) by or on behalf of Operator that directly or indirectly causes the tamper-indicating holographic seal on the computer chip/EPROM to be broken or damaged in any way.

LAI GAMES shall have no liability related to such improper and unauthorized use and/or operation of the hardware and licensed software, and Operator shall indemnify, defend, and hold LAI GAMES harmless for any claim or cause of action brought against LAI GAMES arising from Operator's or Operator's representative's improper and unauthorized use and/or operation of the hardware and licensed software.

ANY IMPROPER AND UNAUTHORIZED USE SHALL COMPLETELY AND TOTALLY VOID ANY AND ALL WARRANTIES, BOTH EXPRESS AND IMPLIED, OF THE HARDWARE AND LICENSED SOFTWARE PROVIDED BY LAI GAMES.

WARRANTY

LAI GAMES warrants its manufactured products for a period of 3 months inclusive of parts and labor from the date of sale.

LAI GAMES exclusive obligation is to repair any item with any defects as a result of faulty workmanship or materials, providing the defective item or items of equipment are returned to the *LAI GAMES* distributor from which the machine was purchased.

LAI GAMES shall have no obligation to make repairs necessitated by negligence or interference to any component by any unauthorized personal. This will automatically void any existing warranty.

IF MAKING A WARRANTY CLAIM:

- (a) A Copy of the sales invoice must accompany the claim.
- (b) To and from Transport and freight costs are not covered by the warranty.
- (c) Warranty is not transferable with the sale of a machine from one owner to another.

