

Repairing the **Kodak Instamatic M80 Projector**

**Includes the
variations in other
M-series projectors.**

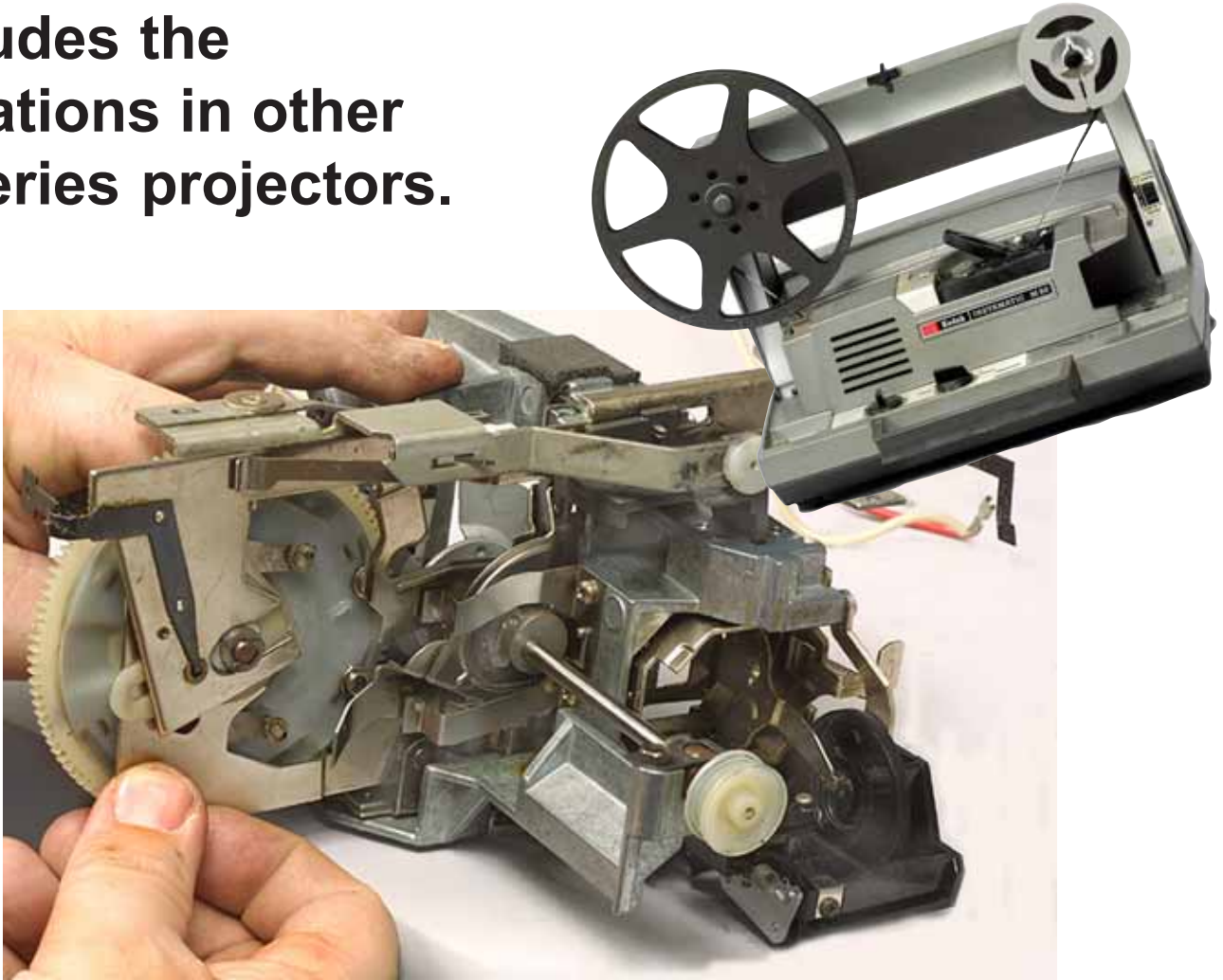

**Plus...Normal Repairs on the
Kodak Moviedeck Projectors.**

A Publication of Fargo Enterprises, Inc.

REPAIRING THE KODAK INSTAMATIC M80 PROJECTOR

...and other models in the M-series.

Plus tips on repairing the Kodak Moviedeck projectors.



Contents

By Curt Fargo & Larry Lyells



M-SERIES

REPAIRING THE M-SERIES PROJECTORS	1
FLOW CHART	2
RECOMMENDED TOOLS	3
INSPECTION, REMOVING THE BOTTOM COVER	4
DISASSEMBLY	6
CHECKING THE CAM BUSHING	12
DISASSEMBLY OF THE MECHANISM	12
SHUTTER REPAIRS & INSTALLATION	16
REPAIRS ON THE CAM-SHAFT ASSEMBLY --	21
INSTALLING AND TIMING THE DRIVE-CAM ASSEMBLY	23
REPLACING THE DAMPING ARM	25
COMPLETING REASSEMBLY OF THE MECHANISM	27
REPLACING THE REWIND DRIVER	31
TESTS AND ADJUSTMENTS	32
FINAL STEPS OF REASSEMBLY	36
TROUBLESHOOTING SUMMARY	36
LUBRICATION SUMMARY	37
WIRING PICTORIALS	37

M80 SPECS AND OPERATION FROM THE KODAK MANUAL	38
Tools, specifications	38
Operation	38
Pulldown system	38
Film selector	39
Spindle operation	40
Rewind operation	40
Direction of shifting operation	41

Courtesy Kodak.



MOVIEDECK SERIES

NORMAL REPAIRS IN THE KODAK MOVIEDECK PROJECTORS	42
DISASSEMBLY STEPS	42
DISASSEMBLY TO REMOVE THE SHUTTER	44
REMOVING AND REPLACING THE SHUTTER	46

©2001 by Fargo Enterprises, Inc. All rights reserved. This publication is for information purposes only. Fargo Enterprises, Inc. is not responsible for any damage caused to projectors while following these procedures. Success in projector repair depends on the skill of the technician.

REPAIRING THE *M-SERIES* PROJECTORS



FIG. B1 The Kodak Instamatic M80 projector.

Many repairs on the M-series of Kodak Instamatic movie projectors are now practical. True, Kodak no longer supplies parts—the projectors have been out of production for too many years. But you can get many parts—including those most frequently needed—through Fargo Enterprises, Inc.

Fargo Enterprises, Inc. has arranged for the frequently needed parts to be specially manufactured or rebuilt. Also, Fargo Enterprises, Inc. acquired the remaining supply of parts from Kodak. If you would like a list of the parts available, contact Fargo Enterprises, Inc. and request a copy of the Micro-Tools catalog. Or check the parts online at www.fargo-ent.com/kodak.htm.

For several years, Fargo Enterprises has also been repairing the M-series projectors. We've gathered our M-series experience for this manual. Here you'll find the instructions for making the normal repairs to the Kodak M-series projectors.

This manual focuses on the M80 projector. But all projectors in the series are very similar. Where there are significant differences, we've described the variations during the disassembly. That way, you can follow these instructions while you're working on any projector in the M-series.

What are the differences? Here's a list of the main variations in the series:

M80. The first projector in the series runs both super-8 and regular-8 film. The special super-8 adapter shown here fits over the supply spindle, increasing the diameter for super-8 reels. The projector has two lamp brightnesses and three running speeds—54 fps, 6fps, and *NORMAL* (18fps). The M80 uses the 120V projection lamp.



M85. A less-expensive version of the M80, the M85 has only one lamp brightness and one running speed (18fps). The M85 also runs both super-8 and regular-8 film. The projector uses the 120V lamp.

M70. The main differences between the M70 and the M80

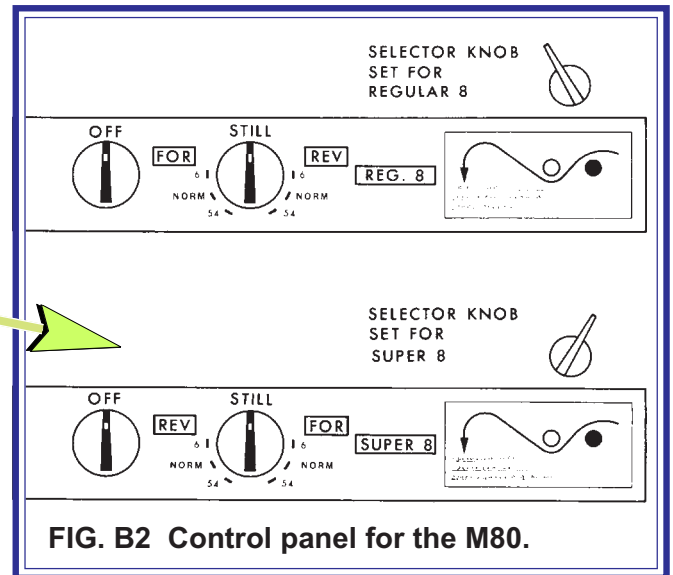

FIG. B2 Control panel for the M80.

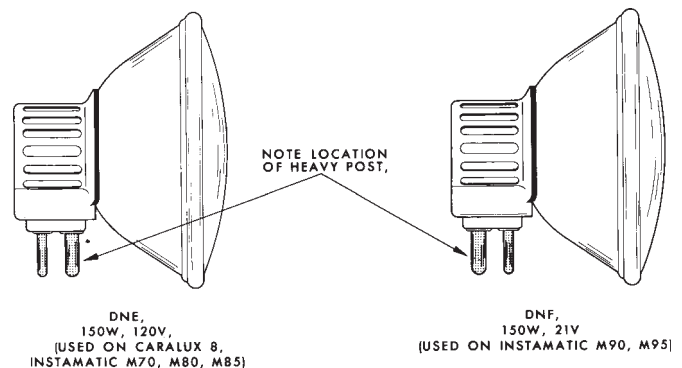

FIG. B3 The two types of lamps. Note that each lamp has one thick pin and one thin pin—the pins are reversed in the two types.

are that the M70 runs only super-8 film and has a single-blade shutter (the M80 has a double-blade shutter). The M70 uses the 120V lamp with two lamp brightnesses.

M90. The M90 is the same projector as the M70 with one exception—the M90 uses the 21V lamp, a variation that requires a step-down transformer in the projector to drop the line voltage to 21V.

M95. Here is the top-of-the line projector in the series. The M95 has all the M-series features. Like the M90, the M95 uses a 21V lamp that requires the step-down transformer.

Another very similar projector is the **Ektagraphic MFS-8**, a super-8 projector closely related to the Instamatic M-series projectors. The MFS-8 has three running speeds, uses the 120V DNE lamp, and adds the convenience of a remote control. There are a few internal variations among the different projectors. You'll see these differences during the disassembly. To see the major electrical differences, turn to the wiring pictorials on page 37.



If you're new to the repair field, you'll need certain tools you probably don't have. See the next section for the recommended tools. Also, there are some standard disassembly/reassembly tips you might keep in mind:

1. You'll see this precaution over and over—but, for your own safety, **never plug in the projector with the bottom cover removed.** Unplug the projector, remove the bottom cover, make any repairs or adjustments, replace the bottom cover, and then plug in the projector to check operation.
2. Try to leave a large enough work area that you can spread out the parts. Keep screws with the parts they hold. A large, clean work area is also desirable to avoid losing parts. Remember, the projectors have been out of production for a long time, and not all parts are available. If you lose a part, you may need to keep searching—it's not always possible to buy a replacement.

3. In this manual, we'll go through reassembly as well as disassembly. But you can always establish your own reassembly sequence—just reverse the order of your disassembly. For this reason, it helps to place the parts in order as you remove them. In some cases, we have used slight variations in the reassembly sequence (for the purposes of testing or to make reassembly a little easier). But you can still simply reverse your disassembly sequence—it's not necessary to follow our reassembly sequence in exact order.

4. It helps to make sure you understand a part's operation before you remove that part. If you're in doubt about some phase of the operation, you might take a disassembly break and check the *Operation* section starting on page 38. Here we used the explanations and drawings provided in the original the Kodak manual, a manual that's no longer available from Kodak.

FLOW CHART

The flow chart for the M80 shows the sequence of operations—what drives what. During the discussions of disassembly, troubleshooting, adjustments, and operation, you may wish to refer to this flow chart to see the order of control. Only the major actions are shown.

An arrow shows the direction of control. A dashed line indicates that the two boxes are actually one part—for example, the up-and-down cams are formed on the shutter-drive shaft.

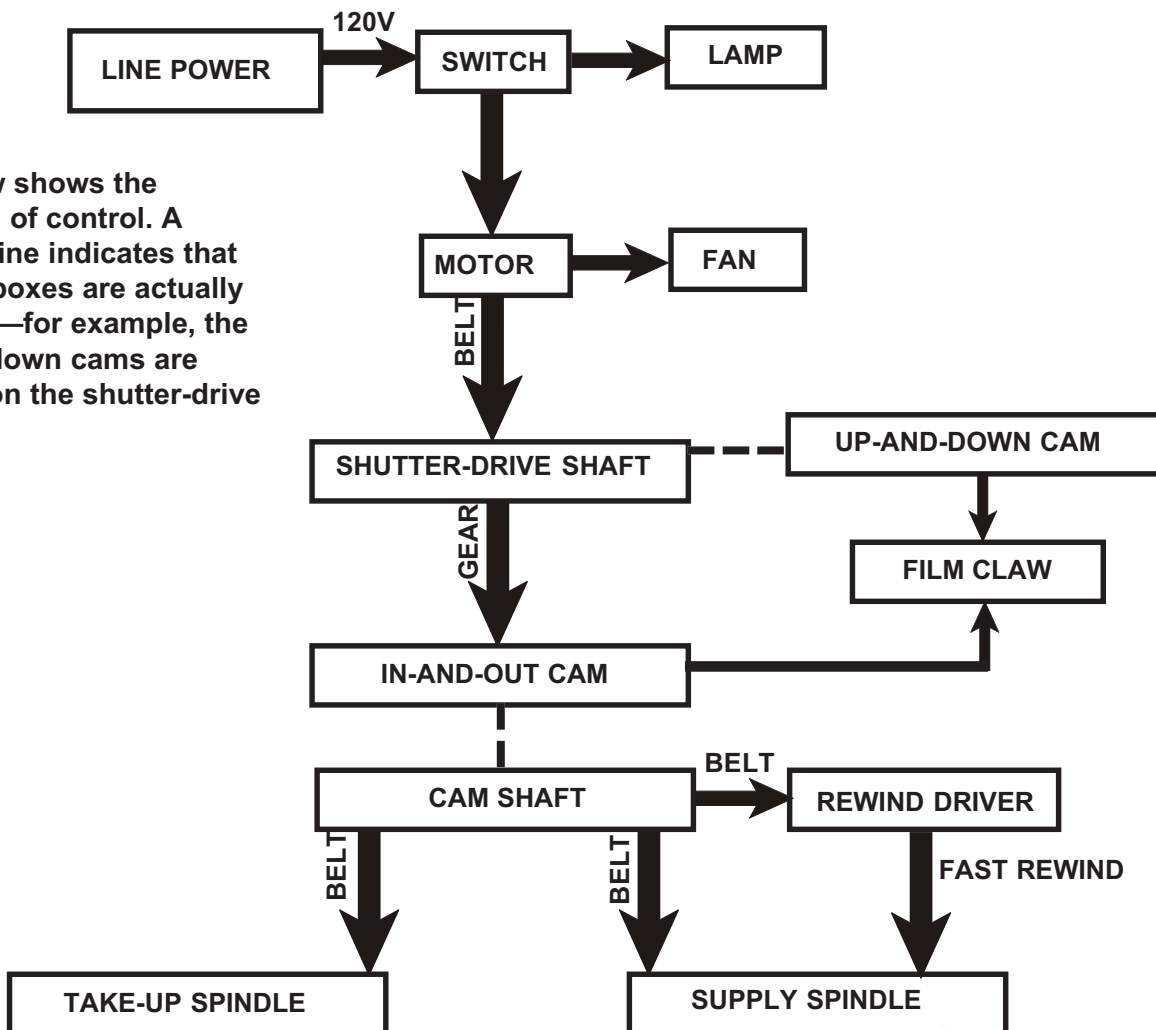

RECOMMENDED TOOLS



FRONT ROW, LEFT TO RIGHT: straight hemostat *HEM-885-10*, curved tweezers *TWZ-302-28*, spring tool *51-1852*.

SECOND ROW, LEFT TO RIGHT: single-edge razor blade, probe (pick) *DD6*, scriber with magnet *7077HS*.

THIRD ROW, LEFT TO RIGHT: Starrett 6" digital caliper *721A-6-150*, Wiha Phillips screwdriver 1x60mm *26110*.

FOURTH ROW, LEFT TO RIGHT: cleaning brush (toothbrush) *BRUSH*, Wiha thin-walled 1/4" nut driver *26563*.

FIFTH ROW, LEFT TO RIGHT: heavy-duty syringe (glass and metal) *DV-101* with blunt needle *18-2* (for grease), syringe *B205-TPR* (for oil), cotton-tip applicator *FB100 362-P* (for a quantity of 100).

BACK ROW, LEFT TO RIGHT: Pliobond adhesive 3oz bottle *P-601-F*, canned air (dusting gas) *1623*, cleaner *AK225 Asahikinlin* 8oz *1663-85-F*, Super Lube grease 3oz tube *21033*, shutter oil *NYOIL*.

There are two types of screws you encounter in the projector—one type has a standard Phillips head and the other type has a hex head (a head with six flat sides). The Phillips screwdriver shown above will handle all the Phillips-head screws. Use the 1/4" nut driver for the hex-head screws. Because of the tight clearances in some cases, the thin-walled nut driver is essential. For the cleaning brush, you can substitute a discarded toothbrush. But you don't want crossed bristles, bending heads, or the other amenities often found in today's toothbrush—that's why we offer a simple, inexpensive toothbrush that's great for scrubbing projector parts. The numbers and letters in italics following the item indicate the order code.

For a complete catalog of tools, contact Fargo Enterprises, Inc. Or check the tools online at www.micro-tools.com/



INSPECTION, REMOVING THE BOTTOM COVER

Inspection—that's the first step when you receive a projector for repair. In a minimum amount of time, you can determine what's wrong with the projector and what parts you may need.

From the outside of the projector, evaluate the overall condition. Check the damping arm, Fig. D1. There's a good chance the plastic has become brittle with age and has broken away, as in the illustrated projector, Fig. D2. Replacing the damping arm requires that you remove the projector mechanism from the housing. But before you order a new damping arm, there are a few more things to check.

To check the shutter mechanism, we'll remove the bottom cover, Fig. D3. **Caution: Be sure to unplug the projector from the wall outlet before you remove the bottom cover.** Working on a partially disassembled projector that's connected to line voltage risks serious electrical shock.

1. Take out the four 1/4" drive screws located within the cavities at bottom of the projector, Fig. D3.
2. Some projectors have an additional two Phillips screws located near the handle. Remove these screws also, Fig. D3.
3. Lift aside the bottom cover as shown in Fig. D7.
4. The power cord in the bottom cover still connects to the projector. To completely remove the bottom cover, first twist off the wire tie, Fig. D7, to separate two of the wires.
5. The other lead of the power cord connects to the switch, Fig. D6. Note the position of the power-cord lead. The power-cord lead connects to the port labeled "L." But the "L" port may be in the lower right-hand corner as in Fig. D6 or in

UPPER BOTTOM-COVER SCREWS



BOTTOM-COVER SCREWS

FIG. D3 Bottom of the M80 projector. Not all projectors have the two upper screws. Note that the bottom cover stores the take-up reel.

FRONT PLATE



FIG. D1 Front view of the M80 projector.

DAMPING ARM



FIG. D2 A broken damping arm.

the upper left-hand corner. Insert your curved tweezers next to the power-cord lead as shown in Fig. D6. Then pull the power-cord lead out of the switch port.

VARIATIONS: If you're working on an M90 or an M95, note the differences in Fig. D8 and Fig. D9. The M90 and M95 use the 21V projection lamp rather than the 120V projection lamp. Projectors that use the 21V lamp have a large step-down transformer, Fig. D9, to drop the line voltage. Also note the difference in the switch position, Fig. D8—the "L" port for the power-cord lead is in the upper left-hand corner.

The bottom cover is now completely disconnected from the projector. Set aside the bottom cover while you examine the projector mechanism.

If the projector won't advance the film, the most likely problem is a damaged shutter gear. Look in the area shown by the dashed circle, Fig. D7. Fig. D4 and Fig. D5 show enlargements of this area. In Fig. D4, the shutter gear has been chewed away—the gear teeth are completely missing. In Fig. D5, the entire gear is missing—the gear has broken, and the sections may be inside the projector.



TIP: Before getting too far into the projector, check the plastic guide—the guide is black plastic in Fig. D7 and white plastic in Fig. D9. If the guide is cracked or broken, there's no use proceeding with the disassembly—you can't get the guide as a replacement part. If the projector belongs to a customer, return it as unrepairable. If you own the projector, you can use it for parts or as a practice mechanism. Or perhaps you can locate an unrepairable projector you can use for parts.

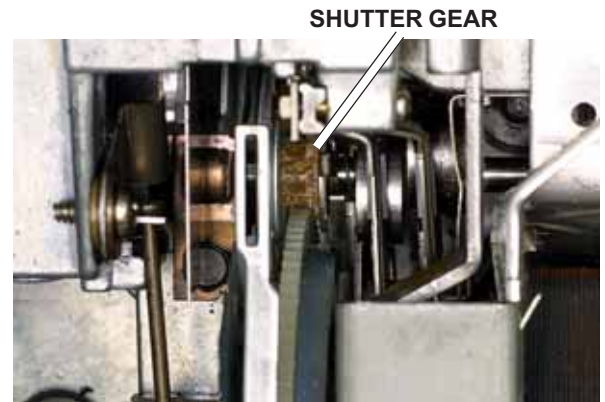

FIG. D4 This projector has a broken shutter gear—a new shutter is needed.

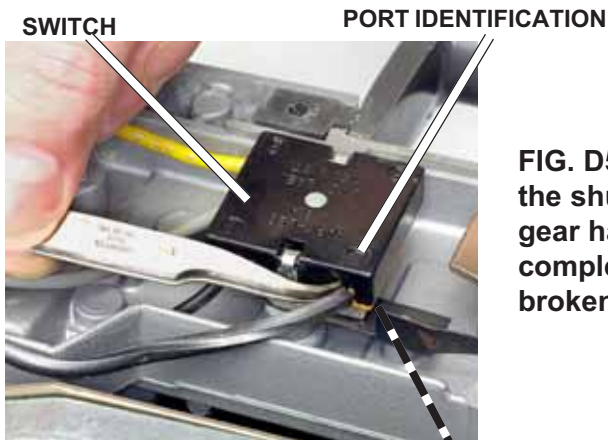

FIG. D5 Here the shutter gear has completely broken away.

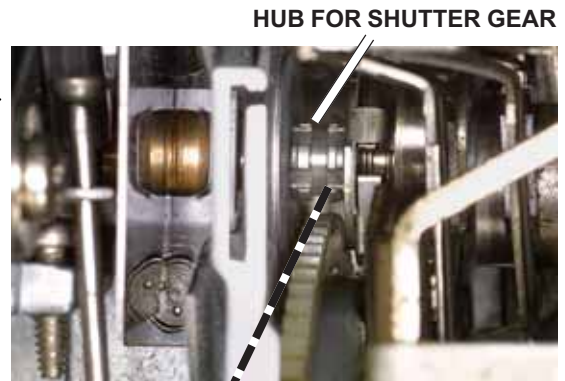

FIG. D6 Unplug the lead of the power cord from the switch.

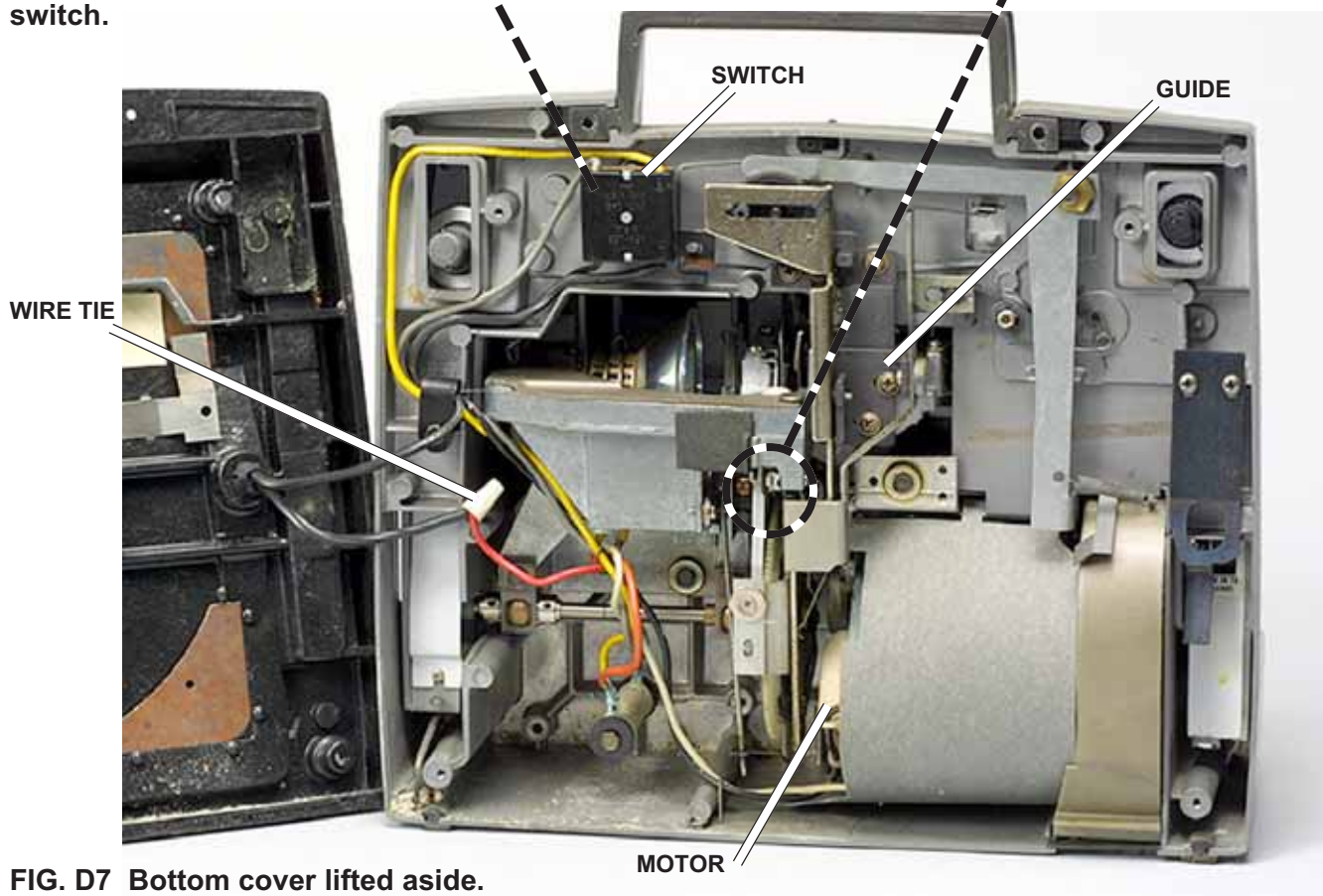

FIG. D7 Bottom cover lifted aside.





FIG. D8 Variation—the switch position is slightly different in the M90 and M95 projectors. The L port is in the upper left-hand corner.

FIG. D9 Variation—the M90 and M95 projectors use a transformer to drop the line voltage for the 21V lamp.

DISASSEMBLY

With either a broken shutter gear or a broken damping arm, it's necessary to remove the mechanism from the projector housing. You'll see the other normal repairs as we proceed. But remember that you'll occasionally encounter the repair you can't perform—simply because the projector is so old that parts are no longer available.

Use your canned air (duster) to blow out the dirt from the inside of the projector. Keep the canned air handy. You'll probably be using it throughout the disassembly to clean out the projector.

1. Lift out the loose grille, Fig. D10.
2. Bow in the paper baffle, Fig. D10, until the slot at its top edge disconnects. Lift out the paper baffle to uncover the motor, Fig. D9.
3. Go now to the front of the projector and lift the top cover as shown in Fig. D1. Snap off the front plate, Fig. D1. Spring tabs hold the front plate to the projector.
4. Still at the front of the projector, remove the lamp, Fig. D11—just push down the wire clip and unplug the lamp.
5. Pull forward the pressure-plate tension arm as shown by the arrow in Fig. D12; then lift up the pressure-plate tension arm to lock it in place. Lift out the pressure plate, Fig. D12.
6. Push down the film-path cover plate as indicated by the arrow in Fig. D13. Lift out the film-path cover plate as you're pushing it down. The U-shaped lower end of the film-path cover plate fits over a post.
7. Slide out the projection lens toward the front of the projector, Fig. D14.

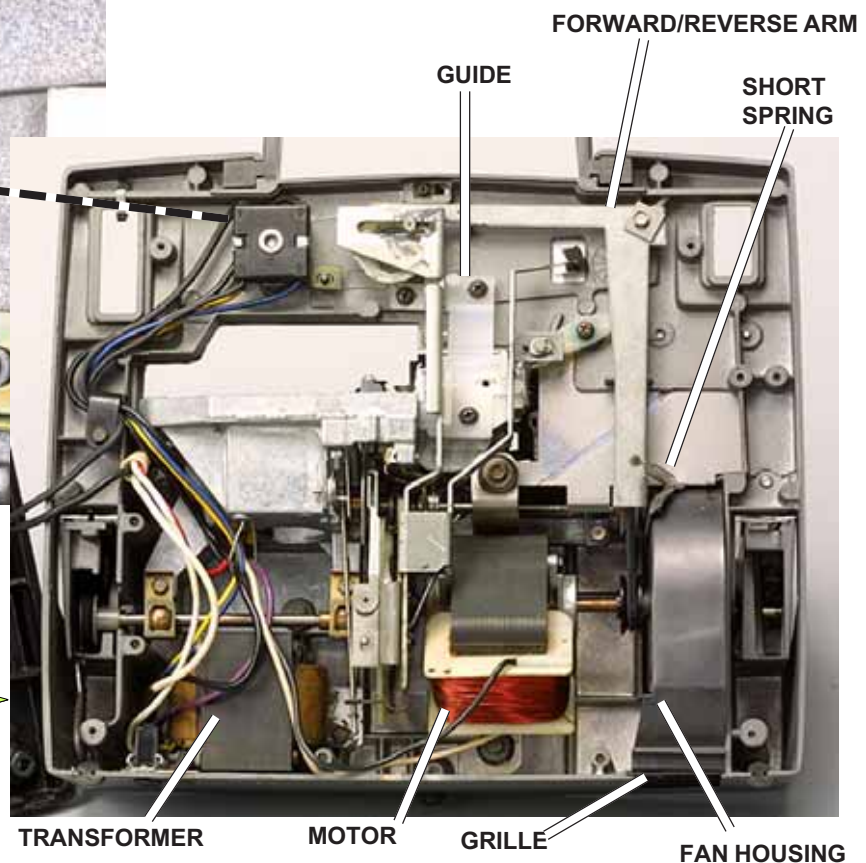

CAUTION: While we're at the front of the projector, note the odd-shaped screwheads on the aperture plate, Fig. D12. No normal screwdriver fits these screws. The odd shape serves as a warning—do not disturb the screws. The screws secure a critical adjustment. Kodak has a special tool that fits the screwheads.

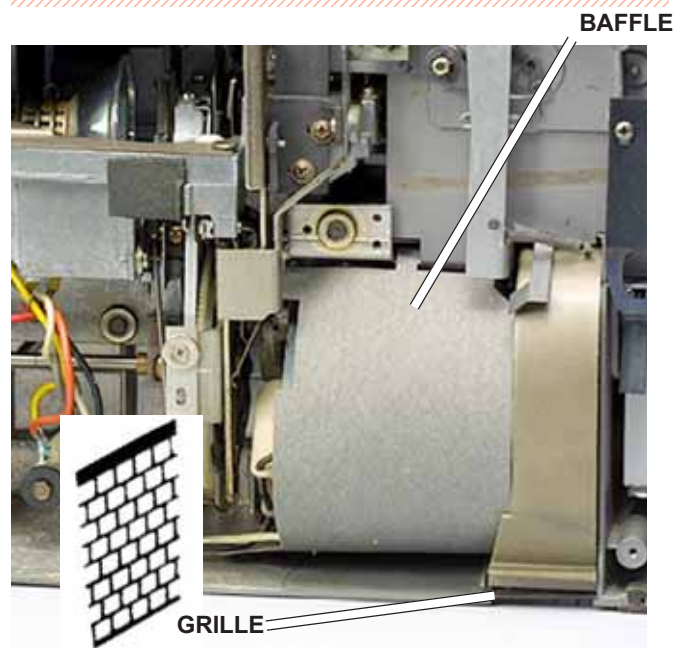

FIG. D10 Bottom of projector, lower right-hand corner.



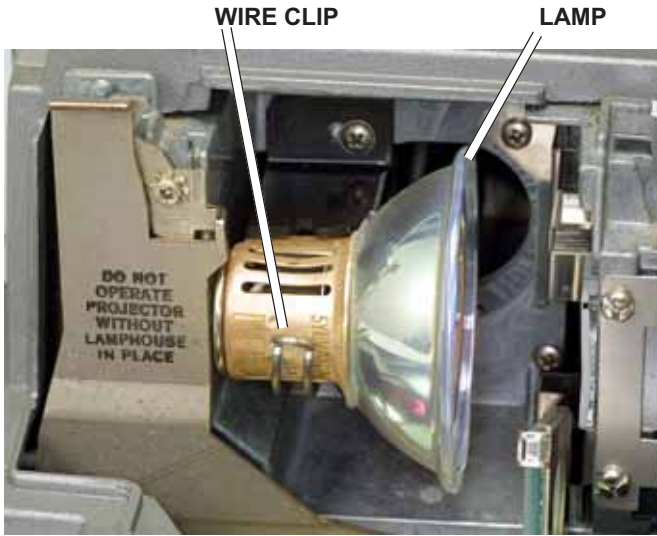

FIG. D11 Front view with front cover removed.



FILM-PATH COVER PLATE

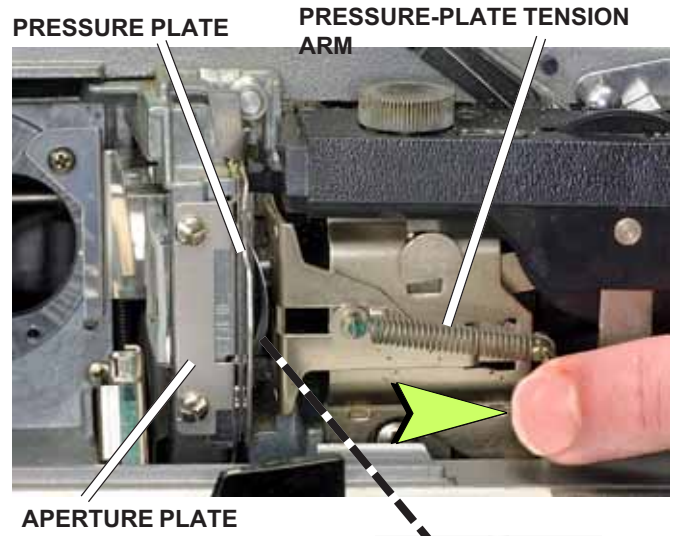
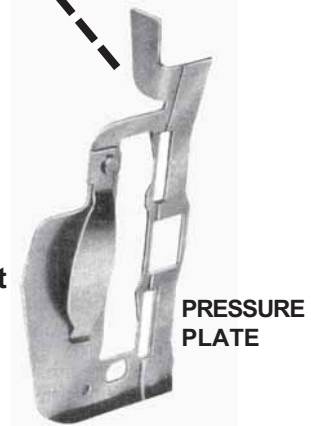

FIG. D12 Front view, front cover removed—removing the pressure plate.



PRESSURE PLATE

FIG. D12 Front view, front cover removed—removing the film-path cover plate.



FIG. D13 Front view, front cover removed—removing the lens.



FIG. D14 M80 with the parts to remove at the front of the projector.



Fig. D14 shows the front of the projector with the parts we just removed. Now return to the bottom of the projector and locate the forward/reverse arm, Fig. D18. The pivot for the forward/reverse arm is an eccentric. The eccentric provides one of the adjustments in the projector. We'll cover adjustments after reassembly. But you can normally avoid having to disturb the adjustment on the forward/reverse arm. Just use your scriber to mark the position of the eccentric as shown in Fig. D15—one scribe mark on the eccentric and a matching scribe mark on the forward/reverse arm. On reassembly, turn the eccentric to line up your scribe marks. You've just retained the adjustment. Unless the adjustment was incorrect at the beginning, it should remain correct.

- Next:
1. Use your 1/4" nut driver to remove the screw passing through the center of the eccentric on the forward/reverse arm, Fig. D15.
 2. Disconnect the spring at the bottom of the forward/reverse arm, Fig. D18.

VARIATION: Kodak uses one of two types of springs on the forward/reverse arm—a short spring (1/2") or a long spring (1"). Your projector may have either type. Fig. D18 shows the long spring; Fig. D9 shows the short spring. Note the difference in the spring-hooking point. The short spring hooks to the tab above the fan housing, Fig. D9; the long spring hooks to a spring-hooking tab nearer the outside edge of the projector, Fig. D18.

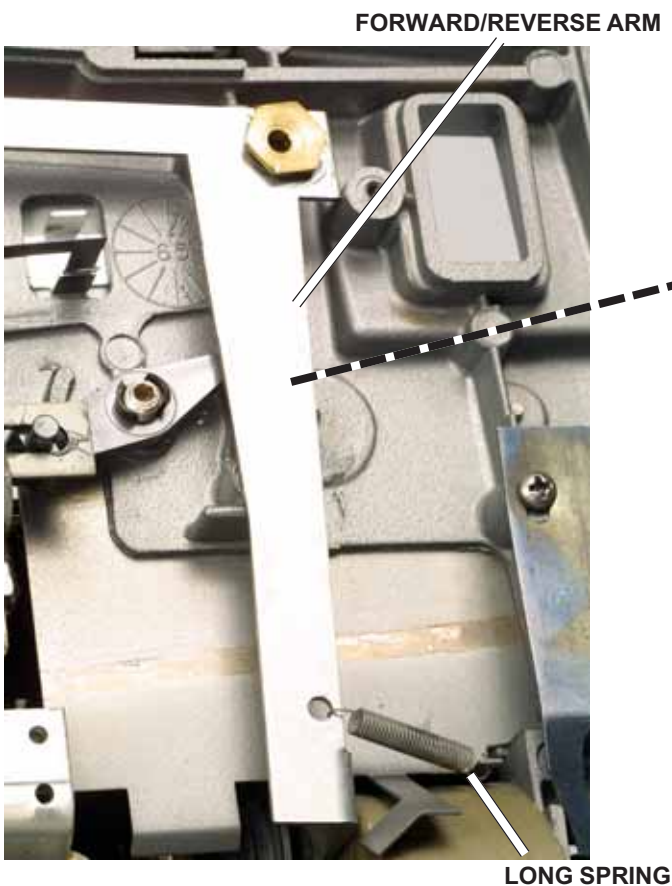
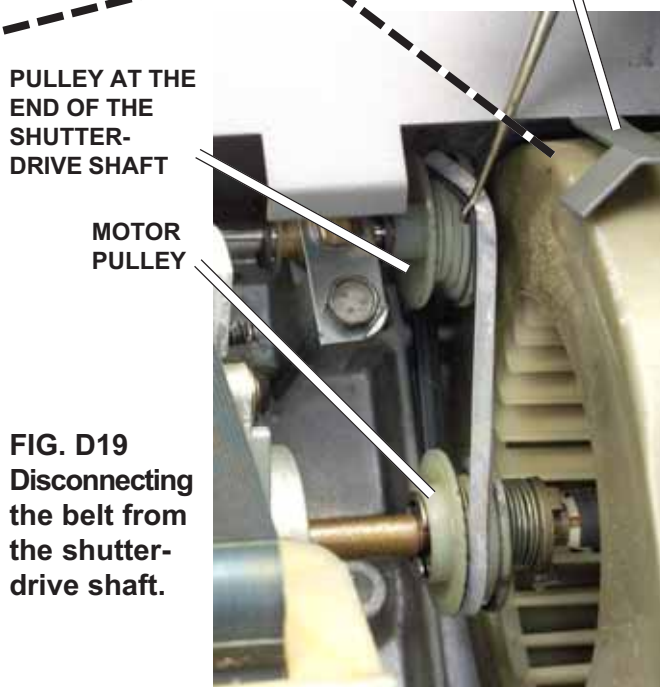
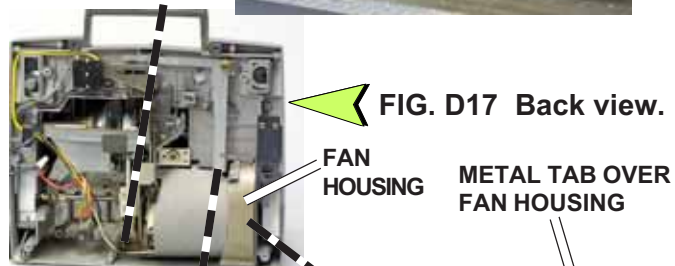
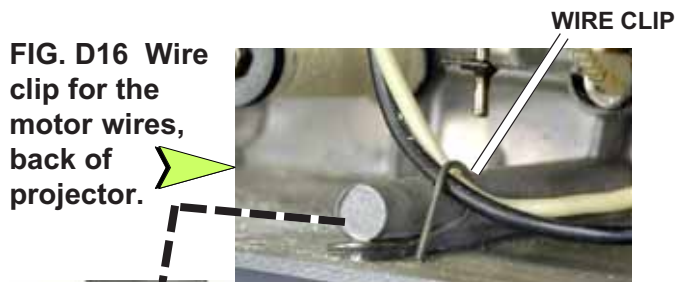

FIG. D18 Bottom view of projector, right-hand side.



FIG. D15 Scribing the eccentric bearing for the forward/reverse arm.



3. Lift out the forward/reverse arm.
4. Using your spring-hooking tool, disconnect the rubber belt from the pulley at the end of the shutter-drive shaft, Fig. D19 (the belt is just to the left of the fan). The belt connects the shutter-drive shaft to the motor. So, as the motor runs, it turns the shutter-drive shaft. And the shutter-drive shaft turns the other parts of the projector.
5. Bend up the metal tab over the fan housing, Fig. D19, to the position shown in Fig. D20 (bending up the metal tab frees the fan housing).
6. Twist out the fan housing to the position shown in Fig. D20.
7. Use your 1/4" nut driver to remove the 2 screws holding the motor, Fig. D22.

TIP: The motor screws pass through rubber grommets. You may find that there's a metal washer between the screwhead and the rubber grommet as in Fig. D21. In that case, the screw should come out without a problem. But if there's no metal washer, the rubber grommet tries to turn with the screw. To turn the screw without tearing the rubber grommet, put some shutter oil between the rubber grommet and the screwhead. The screw will then break loose from the rubber grommet. On reassembly, also apply oil to the rubber grommet; the oil allows the screw to turn without turning or tearing the rubber grommet.

8. Remove the wire clip that holds the black and white wires, Fig. D16.

VARIATION: Some projectors don't use the wire clip for the black and white motor wires. The wires then pass under the casting post as shown in Fig. D23.

9. Remove the wire clip that holds the red, black, white, and yellow wires, Fig. D24 (squeeze together the sides of the wire clip and lift it out).

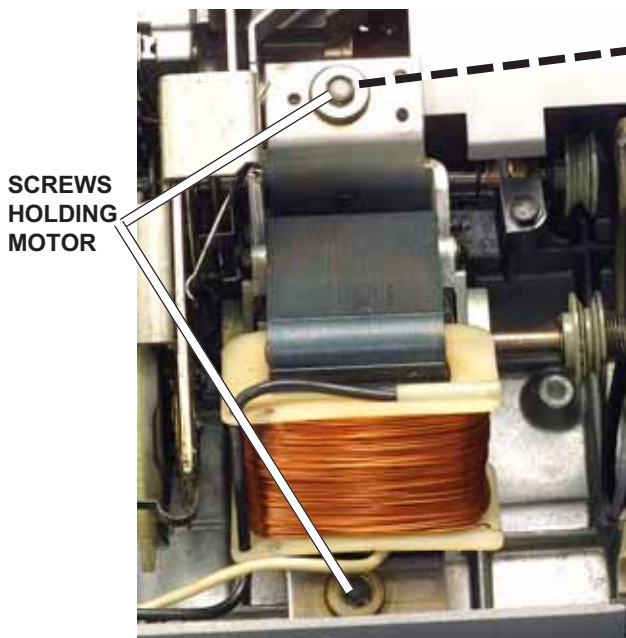
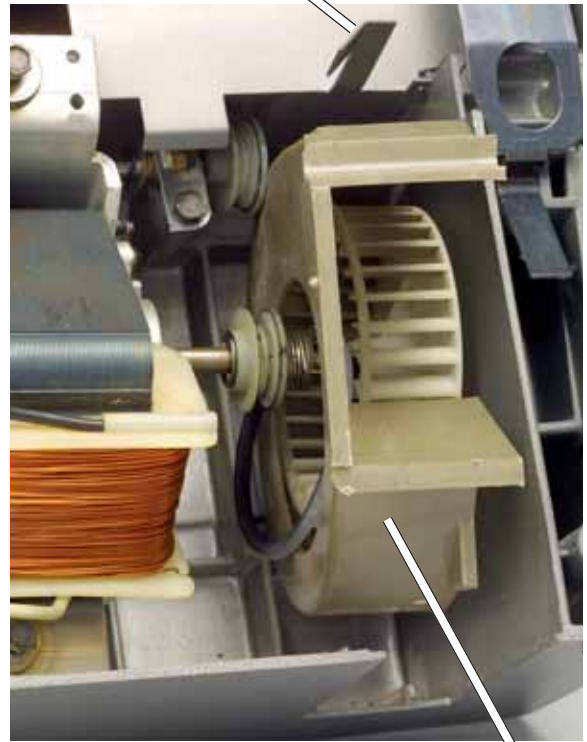

FIG. D22 Back view, lower right-hand corner.

METAL TAB BENT UP FOR CLEARANCE



FAN HOUSING IN POSITION FOR REMOVING THE MOTOR
FIG. D20 Back view, lower right-hand corner.

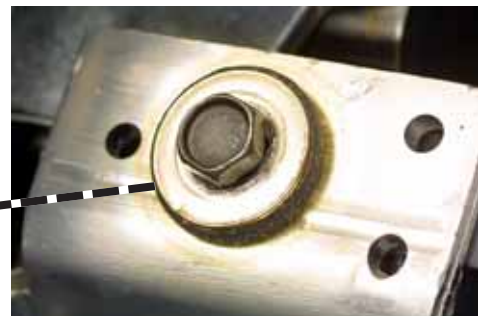

FIG. D21 Motor screw with washer over grommet.

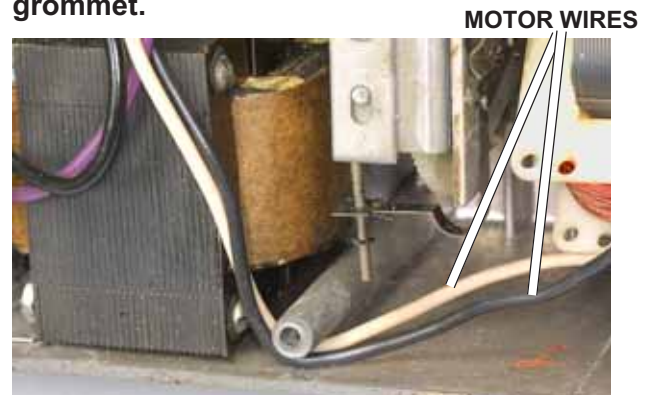

FIG. D23 Variation—routing of the motor wires when no wire clip is used; the photo shows an M95 projector.



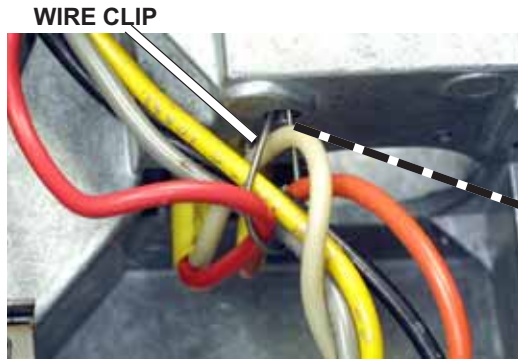

FIG. D24 Remove the wire clip holding the wire bundle.

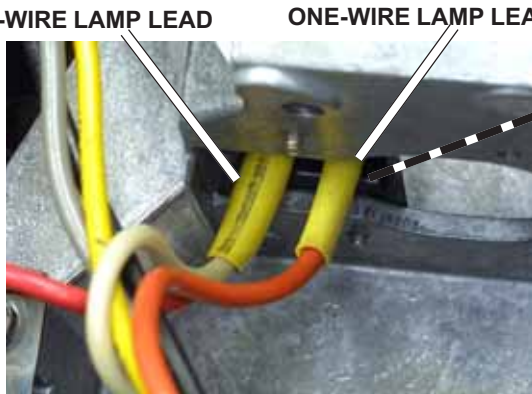

FIG. D26 Unplug the lamp leads.

10. Lift out the motor (leave the wires connected).
11. Pull off the red and white lamp leads, Fig. D26. One lamp lead has two wires—one red and one white. The yellow insulator normally falls off when you disconnect this lead. The insulator on the red-wire lead (the lead with just one wire) normally stays with the wire.
12. Unscrew the long screw holding the wirewound resistor, Fig. D25.

VARIATION: The M80 has two lamp levels. At the lower brightness, the wirewound resistor drops part of the voltage. If the projector you're working only has one lamp brightness, such as the M85, there's no wirewound resistor. And, as you saw earlier, projectors using the 21V lamp have a step-down transformer rather than the resistor.

NOTE: About that corrosion on the wirewound resistor...the corrosion on the wirewound resistor is normal and presents no problem. If the corrosion is severe, you might wipe off the wirewound resistor. The corrosion then won't flake off and get into the mechanism.

13. Remove the Phillips screws holding the guide, Fig. D27 (there are usually three screws, but some projectors have four screws holding the guide—the guide in Fig. D27 has four screws).
14. Using your spring-hooking tool, disconnect the rubber belt from the pulley at the end of the cam shaft, Fig. D29. The other end of this rubber belt goes to the pulley that drives the spindles.

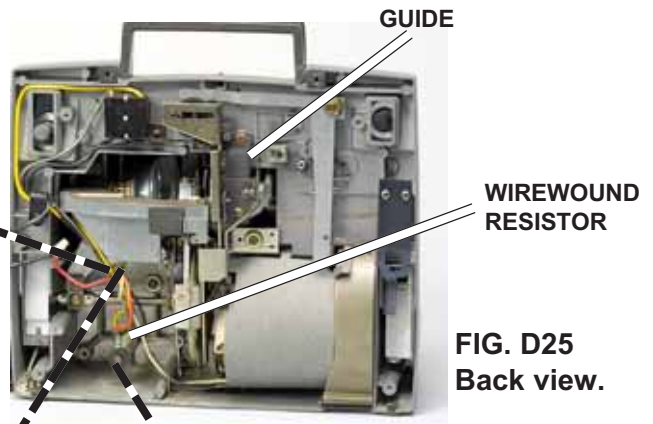

FIG. D25 Back view.



FIG. D27 The wirewound resistor.

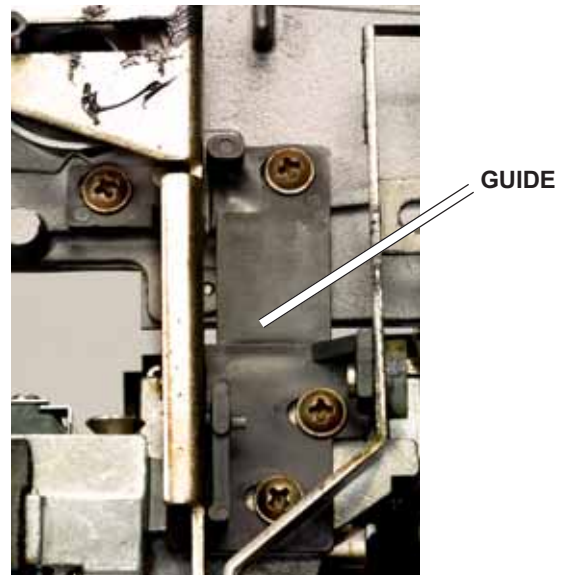

FIG. D28 Remove the screws holding the guide—four in this example.



15. Use your 1/4" nut driver to remove the 3 screws holding the mechanism, Fig. D32. You need a thin-walled nut driver to reach the screw shown in Fig. D30.

VARIATION: In most of the M-series projectors, the slotted tab on the film-selector slide assembly just slips over the post on the cam lever, Fig. D31. But some projectors, such as the one shown in Fig. D31, have a snap ring on the cam-lever post. If you have the snap ring, remove the snap ring before you lift out the mechanism.

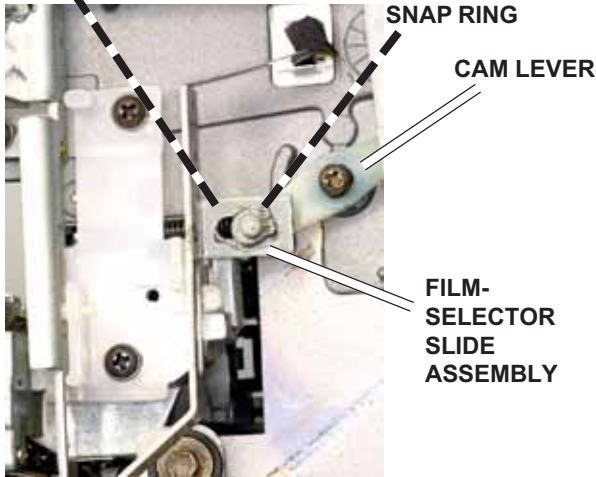
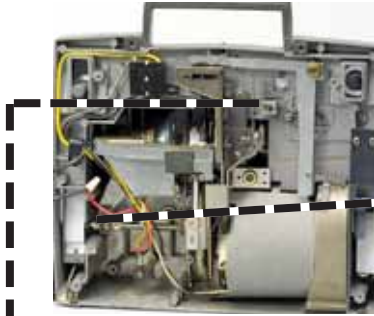

FIG. D31 Variation--a snap ring holds the film-selector slide assembly to the cam lever in the M95.



FIG. D32 Remove the three mechanism screws.

16. Lift out the mechanism, Fig. D33. Tilt the mechanism slightly until the right-hand end clears the case. Fig. D35 shows the mechanism removed.

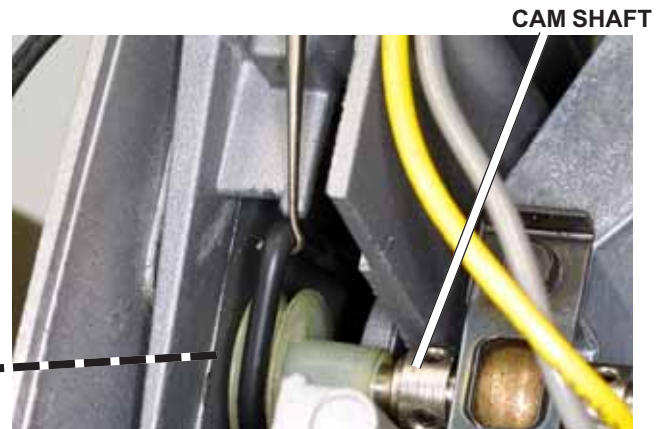

FIG. D29 Unhooking the rubber belt from the pulley at the end of the cam shaft.



FIG. D30 Using a thin-walled 1/4" nut driver to remove the third mechanism screw.



FIG. D33 Lifting the mechanism from the case.



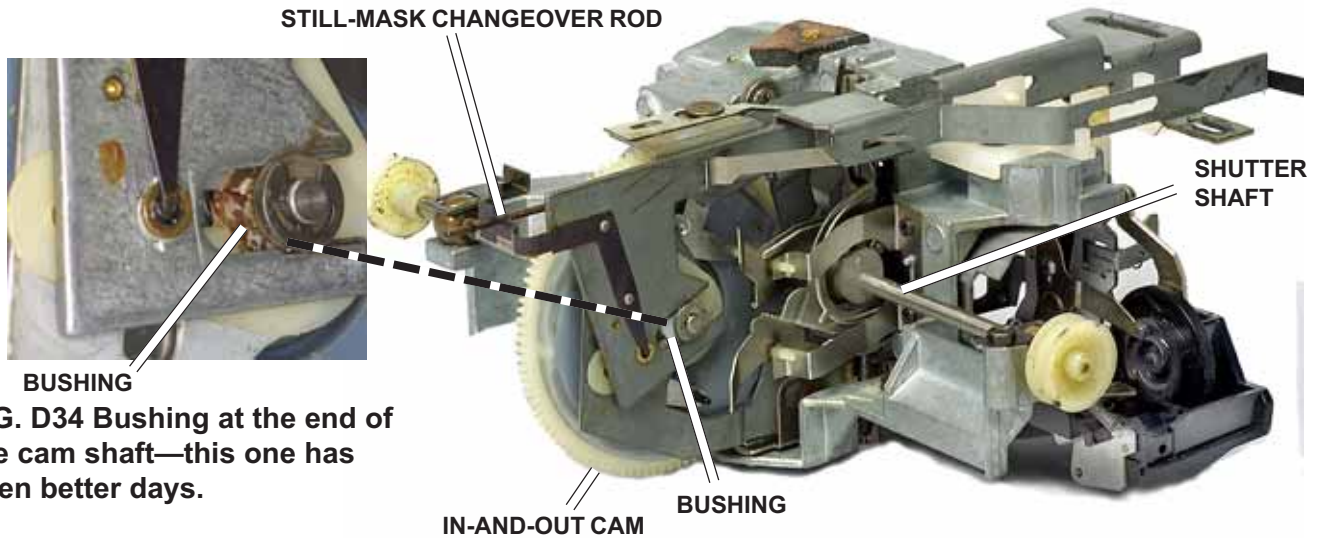

FIG. D34 Bushing at the end of the cam shaft—this one has seen better days.

TIP: Earlier we mentioned that you must remove the mechanism to replace the damping arm. The damping arm is now accessible. However, replacing the damping arm should be your final repair before replacing the mechanism. Why? With the mechanism removed, the damping arm is exposed to further damage. If you replace the damping arm—and then proceed to do further repairs on the mechanism—you may accidentally break your new damping arm.

Before going through the procedure for replacing the damping arm, let's look at the other repairs on the mechanism.

CHECKING THE CAM BUSHING

The in-and-out cam, Fig. D35, runs on a plastic bushing—the white bushing pointed out in Fig. D34. Replacing the bushing is another normal repair in the projector. Again age and humidity are the enemies. The plastic bushing deteriorates with age and atmospheric conditions.

Fig. D34 shows a bushing that has deteriorated. The brown color (rather than white) is one indication of deterioration. In Fig. D34, you can actually see that the bushing is breaking up. Fig. D36 shows another obvious example—here the bushing is completely missing. But if you're in doubt, use the sharp point of your probe to push against the plastic bushing, Fig. D37. If the bushing breaks up, it should be replaced. Replacing a questionable bushing now may save you a problem down the road.

There are two different bushings—an early style and a late-model style. Only the late-model style is available as a replacement part. However, as you'll see a little later, you can adapt the late-model bushing for a projector with early style parts.

DISASSEMBLY OF THE MECHANISM

Locate the still-mask changeover rod in Fig. D35. The still-mask changeover rod moves the still-mode lever, bringing

FIG. D35 Mechanism removed from the housing.



FIG. D36 Here the cam-shaft bushing is completely missing.



FIG. D37 Probing the cam-shaft bushing to test its condition. This one needs to be replaced.



the heat-absorbing filter into the light path at the still-frame function. Since the film isn't then moving, it needs the additional protection of the still-mode heat-absorbing filter—otherwise, the film may burn if you keep one frame in the light path too long.

The position of the snap ring on the still-mask changeover rod provides an adjustment, Fig. D38—the snap-ring position controls the movement of the still-mask changeover rod. The adjustment then determines if the heat-absorbing filter is fully in the light path in the still-frame mode—and completely out of the light path at the other modes.

You lose the adjustment when you remove the snap ring. So **note the position of the snap ring prior to disassembly**, Fig. D38. The snap ring is normally around 1/4" from the end of the still-mask changeover rod. Make a note or a sketch of the snap-ring position. Then:

1. Disconnect the coil spring from the still-mask changeover rod, Fig. D38. Remove the spring from the projector.
2. Pull out the still-mask changeover rod toward the top of the mechanism. The still-mask changeover rod passes through a slot in the still-frame lever.
3. Straighten the arm of the super 8/regular 8 mask, Fig. D40, so it will pass through the slot in the tab as you lift out the drive-cam assembly.
4. Loosen the 2 screws that hold the spring clamps for the cam-shaft brass bearings, Fig. D41. Swing aside the spring clamps and lift out the cam assembly, Fig. D41.

CAUTION: Be careful to prevent the regular-8 and super-8 followers, Fig. D42, from coming out at this stage. Projectors with both regular 8 and super 8 have two



FIG. D40 Coupling to the super-8/regular-8 mask.

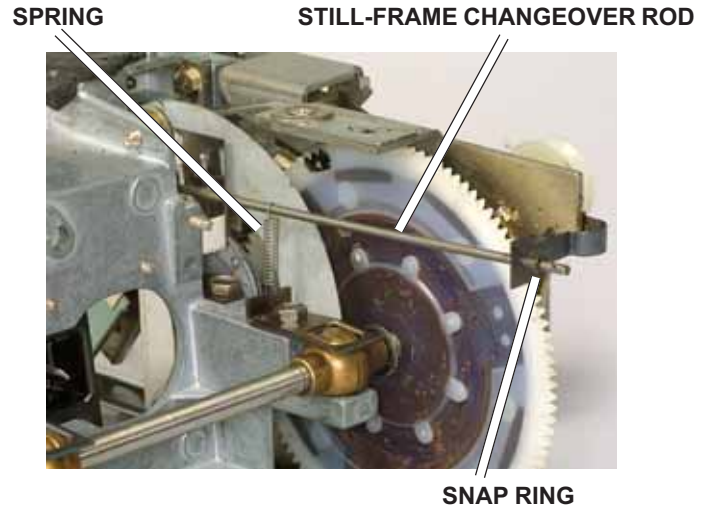

FIG. D38 Bottom of mechanism.

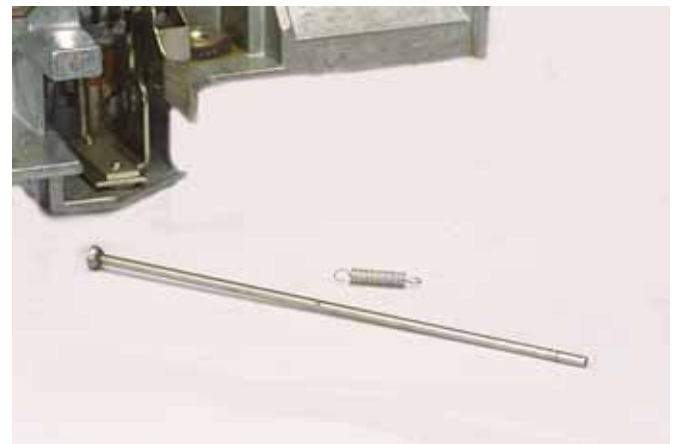

FIG. D39 Still-mask changeover rod and spring removed.

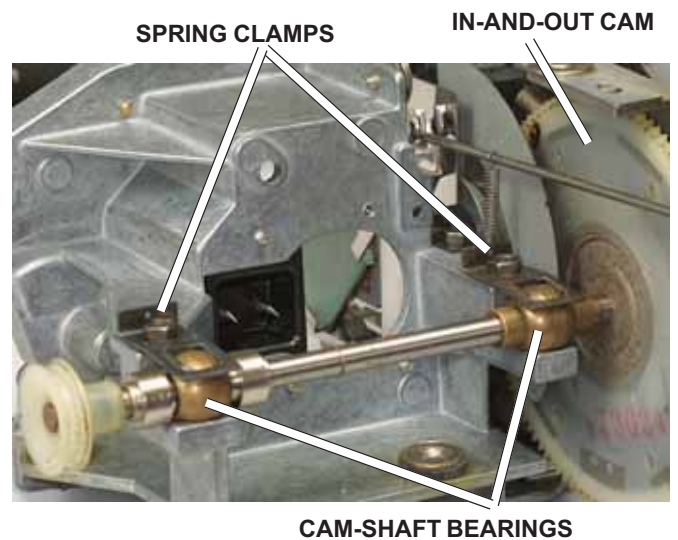

FIG. D41 Loosen the screws holding the spring clamps to remove the cam assembly.



followers that look like white bullets. One follower controls the in-and-out claw movement for super 8; the other follower controls the in-and-out claw movement for regular 8. If you're working on a projector that just accepts super 8, there's only one follower.

The followers provide critical adjustments—the **length of a follower controls the depth of claw engagement**. The followers in a particular projector may be different in length—as well as different from the followers in another projector. It's therefore critical that you **return the followers to their original positions**.

Here's one technique you can use—*mark one of the followers*. It doesn't matter which follower you mark as long as you know and remember. As a rule, we mark the super-8 follower shown in Fig. D43 with a red marker. During *Adjustments and Tests*, you'll see that you can remove and replace the followers with the mechanism installed in the projector. The super-8 follower is then closer to the top—and closer to you—as viewed from the bottom of the projector.

5. Lift the follower arms slightly and remove the followers.

TIP: Here's one place the hemostat (described in the tool section) comes in handy. Clamp the hemostat on a

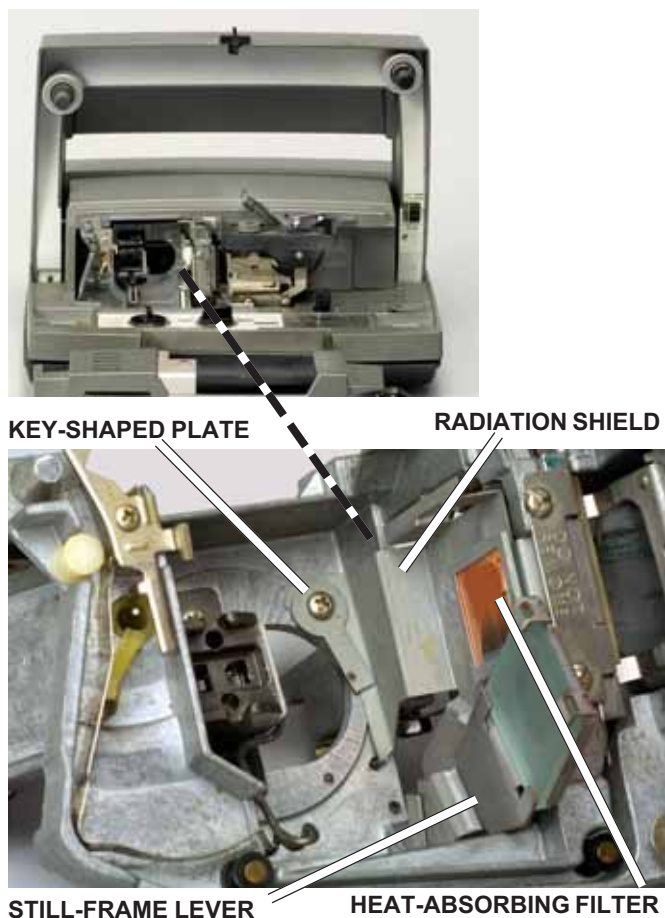

FIG. D44 Lamp chamber at the front of the projector.

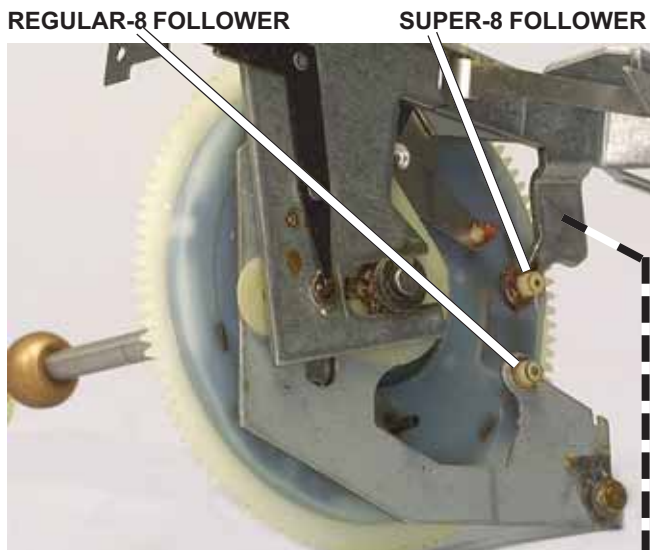

FIG. D42 Cam assembly.



FIG. D43 Marking the super-8 follower with a felt-tip pen.

follower before you lift the follower arm. Then lift the follower arm only as far as necessary to remove the follower. Using the hemostat helps prevent loss of the followers—especially if you're removing and replacing the followers with the cam-shaft assembly installed in the projector.

6. From the front of the projector, remove the radiation shield (the plate with the heat-absorbing filter, Fig. D44). Depending on the projector, there may be one screw or two screws holding the radiation shield. Some projectors have the key-shaped support plate shown in Fig. D44 under one screw.

7. Loosen the screw holding the spring clamp for the shutter-drive-shaft bearing shown in Fig. D46. Shift the spring clamp away from the top of the shutter-drive-shaft bearing.



CAM FOLLOWERS



FIG. D45 Up-and-down cams at the end of the shutter-drive shaft.

8. In Fig. D45, you can see the cams on the shutter-drive shaft. These cams—one for super 8 and one for regular 8—drive the claws up and down (the in-and-out cam, you'll recall, drives the claws in and out). Turn the shutter shaft counterclockwise (as seen from the pulley end) until the two cams are parallel to the cam followers on the claws, Fig. D45. Then pull out the shutter-drive shaft, Fig. D46.

CAUTION: A coil-type (compression) spring fits over the end of the shutter-drive shaft, Fig. D48. The spring will be loose when you lift out the shutter-drive shaft.

VARIATION: If the projector just runs super-8 film, there's only one cam at the end of the shutter-drive shaft, Fig. D49.

9. Lift out the shutter, Fig. 49. Watch for loose washers.

NOTE: There should be a washer between the shutter and the shutter-shaft bearing that's still in the mechanism. You may find additional washers on the shutter-drive shaft. But only one washer is needed. Save any additional washers for spare parts—the washers are no longer available from Kodak. And if you lose the washer? Keep searching. As you'll see in a moment, the washer is important.

CAUTION: The cam followers for the up-and-down claw movement are now loose, Fig. D45. The cam followers can come off the claws once you remove the shutter-drive shaft. Fig. D52 shows the same view as Fig. D47, but we've removed one of the cam followers.

10. To make reassembly a little easier, also remove the rear bearing (shutter side) for the shutter shaft, Fig. D50 (just



FIG. D48 Shutter-drive shaft.

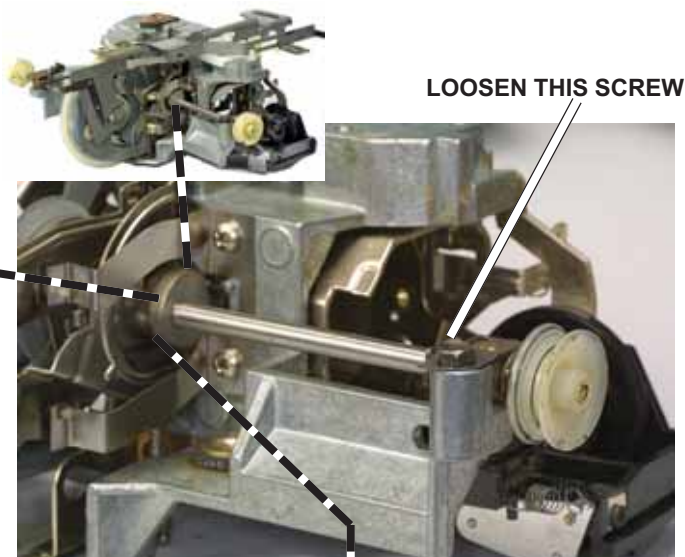

FIG. D46 Shutter-drive shaft.

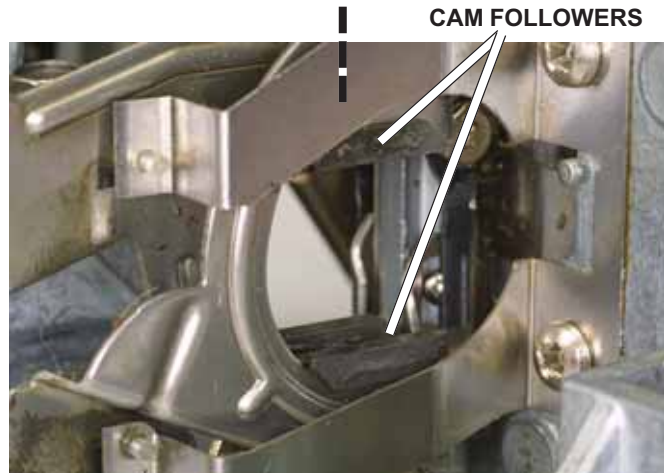

FIG. D47 Claw assembly with shutter-drive shaft removed.

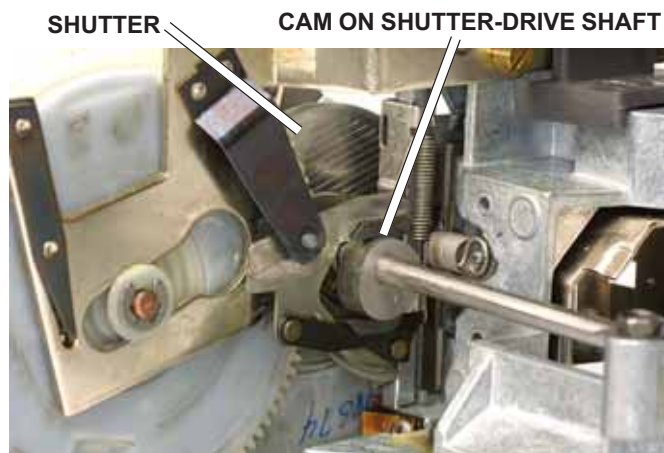

FIG. D49 Variation—the M70 and M90 projectors only run super 8. The shutter-drive shaft then has just one cam to drive the claw assembly.



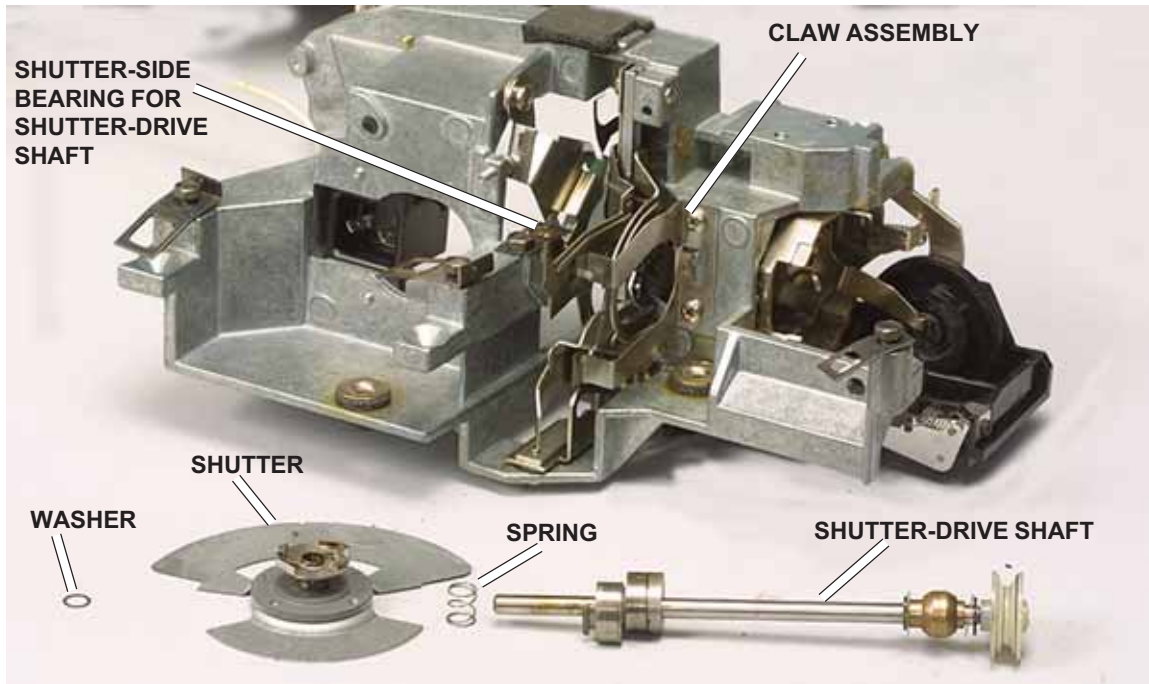

FIG. D50 Parts of the shutter removed from the mechanism.

loosen the screw and swing aside the spring clamp, Fig. D51). As you'll see on reassembly, you can then simply seat the bearing over the end of the shutter-drive shaft—*after* you've installed the shutter-drive shaft in the mechanism. That's a lot easier than trying to thread the shutter-drive shaft through the bearing hole.

Now, with both the in-and-out cam and the shutter removed, you can perform practically all of the repairs you'll be making on this projector. There's rarely a reason to remove the claw assembly, Fig. D50. However, we've removed the claw assembly in Fig. D53 just to show the ball bearings. Remember, if you lift the claw arms too far, the ball bearings can fall out.

You can lubricate the ball bearings without removing the claw assembly. Use your oil syringe to lubricate the tracks in which the balls ride, Fig. D54.

SHUTTER-SIDE BEARING FOR SHUTTER-DRIVE SHAFT



FIG. D51

SHUTTER REPAIRS & INSTALLATION

As mentioned earlier, the plastic shutter gear can break or deteriorate. Then, since the shutter drives the in-and-out



FIG. D52 Cam follower removed from the claw assembly. The cams on the shutter-drive shaft ride against this follower to provide the up-and-down claw movement.



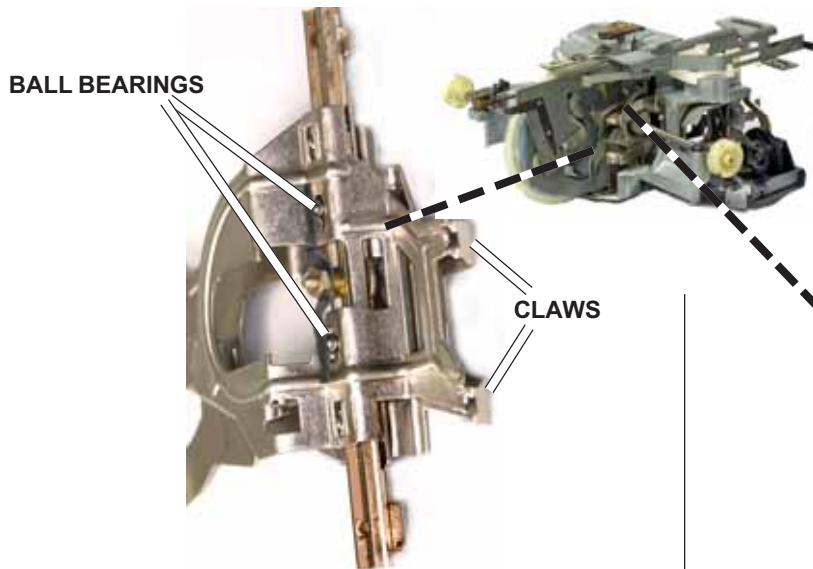

FIG. D53 Claw assembly.

cam—and the in-and-out cam drives the spindles—the projector won't transport film. Although you can't obtain a new shutter, you can purchase a rebuilt shutter from Fargo Enterprises, Inc. The rebuilt shutters have new Delrin gears.

But not all shutters can be rebuilt. The projector may have either the early style or the late-style shutter, Fig. D56. The early style shutter can't be rebuilt. However, you can install a rebuilt shutter in a projector that has the early style shutter.

If you have the late-style shutter, send it to Fargo Enterprises, Inc. as an exchange for the rebuilt shutter. Sending in your old shutter will save you money on the rebuilt shutter. The shutters come in either of two sizes according to the diameter of the center hole. Here's where you need the caliper to determine which shutter you need.

Measure the diameter of the shutter-drive shaft, Fig. D55. You should measure either 0.187" or 0.185". As you can see, there's only 0.002" difference between the two sizes. Unless you have a digital caliper, it's difficult to read to such high resolution.

You now have all the information you need—the diameter of the shutter-drive shaft and the number of blades on the shutter. Fig. D56 shows double-blade shutters; a single-blade shutter has just one blade. Order the replacement shutter by one of the following part numbers:

- 198395** double-blade, 0.187"
- 178642** double-blade, 0.185"
- 198574** single-blade, 0.187"
- 178641** single-blade, 0.185"

Also note the disk with two flat springs at the front of the shutter, Fig. D57. The springs are for reducing chatter. Kodak has never provided the spring unit as a replacement part—the spring unit was only provided as



FIG. D54 Use the shutter oil to lubricate the ball bearings in the claw assembly.

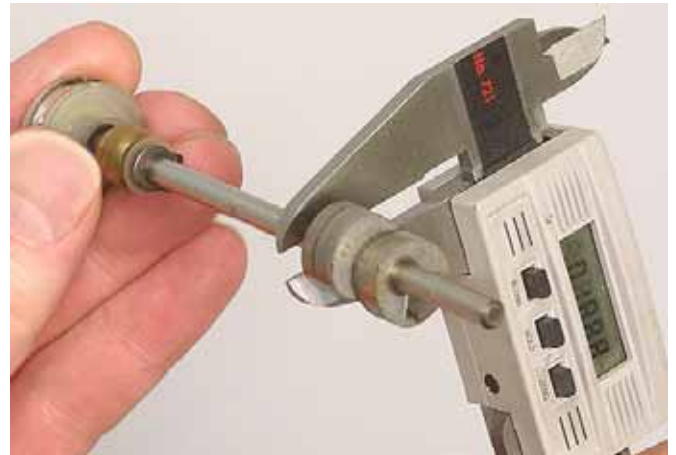

FIG. D55 To determine which shutter you need, measure the diameter of the shutter-drive shaft.



LATE-STYLE SHUTTER

EARLY STYLE SHUTTER

FIG. D56 Only the late-style shutter (left) can be rebuilt.



part of the shutter.

The spring unit may be cemented to the shutter. Or it may be spot welded. If possible, **remove the spring unit before you send in the shutter for exchange**—the rebuilt shutter does not include the spring unit. However, if you can't remove the spring unit, include a note to Fargo Enterprises indicating that you need the spring unit also. You'll then get a spring unit for the rebuilt shutter.

You can cement the spring unit to the rebuilt shutter, Fig. D58. Then align the slots in the spring unit with the shutter tabs. Cementing the spring unit isn't necessary—once you install the replacement shutter in the mechanism, the spring unit stays in place. But, with spring unit cemented, you can more easily install the shutter.

Clean the shutter and the shutter-drive shaft with a plastic-safe degreaser—such as the AK225 described in the tools section. Then use your syringe with shutter oil to lubricate the shutter-drive shaft where it passes through the pulley-side bearing, Fig. D59.

There are two types of the shutter-side bearing, Fig. D60—depending on whether you have the early model shutter or the late-model shutter. If you have the early style shutter, the shutter-side bearing has a shoulder—a smaller section that faces the shutter. A rear bearing for the late-model shutter has no extension—that's because the shutter has the extended shoulder at the center, Fig. D56.

But, even if you're installing a late-mode shutter in a projector that had the early style shutter, you can use the same rear bearing. Just flip the rear bearing 180°. The flat side of the rear bearing then faces the shutter.

If you have the late-model shutter-side bearing, take a look at the surface that faces the shutter, Fig. D60. You may find that the rear bearing has a groove worn around the center hole. The groove tells you that someone had installed the shutter-drive shaft without the washer. The shutter then wore the groove during operation. After replacing the shutter, flip the shutter-side bearing 180°. The side that isn't worn now faces the shutter. And be sure to **replace the washer**.

You're now ready to replace the shutter and the shutter-drive shaft. Seat the shutter in the mechanism with the spring unit facing the claw assembly.



FIG. D59 Lubricating the shutter-drive shaft.



FIG. D57 Spring unit at the front of the shutter. This one is already loose.



FIG. D58 You can cement the spring unit to the front of the shutter using Pliobond.



FIG. D60 The groove shows wear in the shutter-side bearing--most likely, the washer was left out.



Make sure that the two cam followers are seated on the claws, Fig. D52. Then seat the shutter-drive shaft. Remember the position of the up-and-down cams you noted during disassembly—parallel to the cam followers, Fig. D61. For reassembly, start with the larger cam at around a 45° angle as indicated by the dashed line in Fig. D61. Then, as you seat the shutter-drive shaft, turn the shutter-drive shaft clockwise until the cams are horizontal, Fig. D61. The shutter-drive shaft should now seat fully.

VARIATION: Seating a shutter-drive shaft that just has one cam is a little easier—the position of the cam isn't critical. Pull down the claw assembly, Fig. D63, and insert the shutter-drive shaft.

Hold up the shutter-drive shaft as shown in Fig. D62 as you seat the parts at the other end. Fig. D64 shows the end of the shutter drive shaft passing through the shutter—this is the end that also passes through the shutter-side bearing. Use your oil syringe to lubricate the end of the shutter-drive shaft, Fig. D64.



FIG. D62 Holding the shutter-drive shaft in place to replace the parts at the front of the shutter.



FIG. D64 Lubricate the front of the shutter-drive shaft with shutter oil.



FIG. D61 Installation position for the M80 shutter-drive shaft—start with the large lobe on the dashed line and then turn the shutter-drive shaft clockwise to the position shown.



PULL DOWN THIS SECTION OF THE CLAW ASSEMBLY

FIG. D63 Variation—claw assembly in the M70 projector.



Seat the washer over the end of the shutter-drive shaft, Fig. D64. Next seat the shutter-side bearing, Fig. D65. Remember that there are two types of shutter-side bearings. Fig. D65 shows the early style. But here, because we've installed the late-style shutter, we've flipped the rear bearing 180°. If you haven't replaced the shutter—and you're using the early style shutter—the smaller end of the shutter-side bearing faces the shutter (180° from the position shown in Fig. 65).

Seat the wire clamp over the shutter-side bearing and tighten the screw. Finally tighten the screw for the pulley-side bearing, Fig. D66.

Check the freedom and operation of the shutter-drive shaft by turning the pulley, Fig. D66, in a counterclockwise direction (as seen from the pulley end of the shutter-drive shaft). The shutter-drive shaft should turn freely, and the claws should move up and down.

PULLEY-SIDE BEARING



PULLEY

FIG. D66 Lubricate the cams of the shutter-drive shaft with grease.

IN-AND-OUT-CAM FOLLOWERS

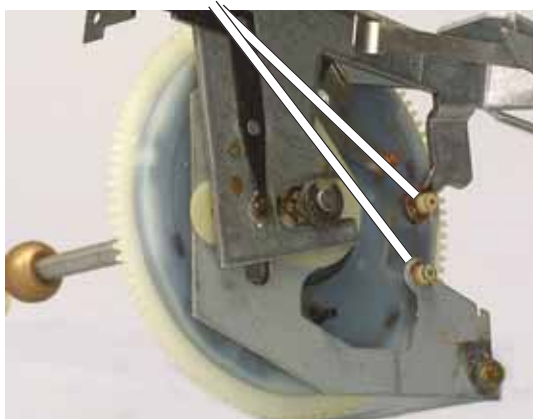

FIG. D67 Cam assembly.

Using your grease syringe, lubricate the cams on the shutter-drive shaft, Fig. 66. Also grease lubricate the surfaces of the claw arms, Fig. D68, that come against the followers of the in-and-out cam, Fig. D67.



FIG. D64 Replacing the washer over the shutter-drive shaft.



FIG. D65 Seat the shutter-side bearing. Here we've flipped an early style shutter-side bearing so the large surface faces the new-style shutter.



FIG. D68 Lubricate the arms that contact the in-and-out-cam followers with grease.



REPAIRS ON THE CAM-SHAFT ASSEMBLY

Other than cleaning and lubrication, there's only one repair you'll normally make on the in-and-out cam—replacing the bushing, Fig. D69. Remember, the plastic bushing at the front of the in-and-out cam deteriorates with age and humidity.

Earlier we mentioned that there are two different styles of bushings. The early model bushing has one shoulder; the late-model bushing has two shoulders, Fig. D70. You can only get the late-model bushing (part #177874). But if the projector you're repairing has the early style, you can make a modification to use the later style.

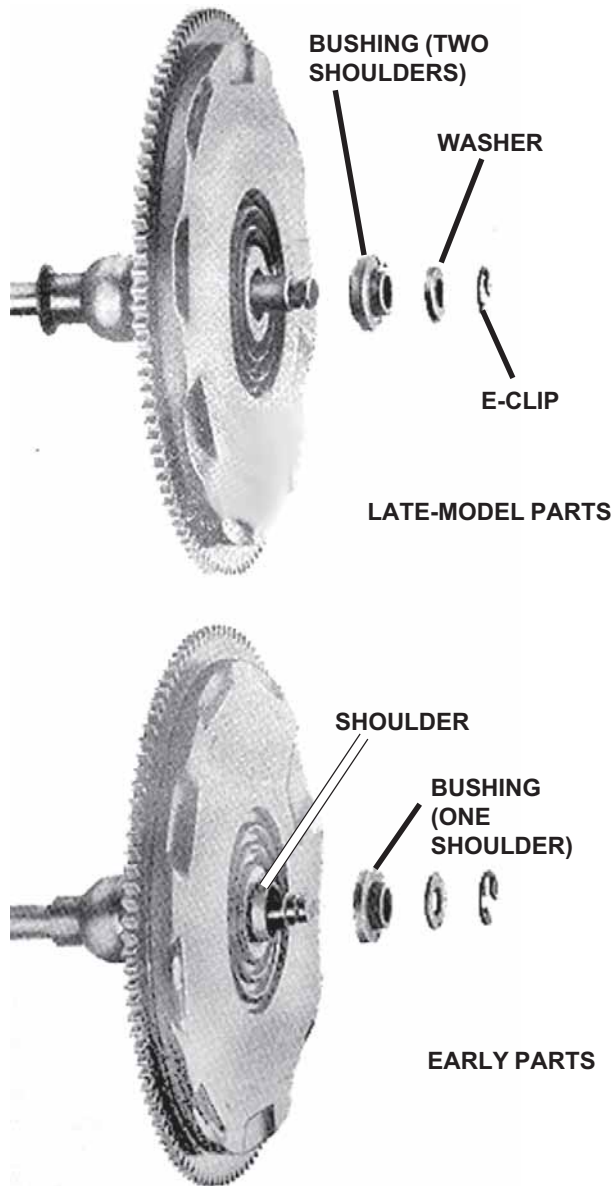

FIG. D70 The late-model in-and-out cam (top) and the early model (bottom). Note the difference in the bushings and the shoulder at the center of the early style in-and-out cam.

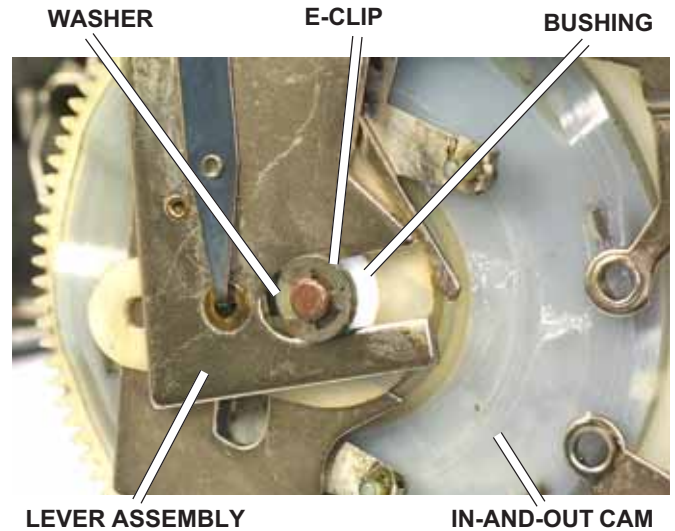

FIG. D69 Front of the in-and-out cam; the followers have been removed.

Remove the E-clip and washer holding the lever assembly to the front of the in-and-out cam, Fig. D69. Remove the lever assembly, Fig. D69. You can now clearly see if you have the early style or late-model parts. Again, if you have the late-model parts, the bushing has two shoulders, Fig. 70 (top). Also, the front of the in-and-out cam has no raised shoulder around the center hole. You can then use the replacement bushing as is—there's no modification required.

Fit the replacement bushing to the lever assembly as shown in Fig. D72 and Fig. D73. The shoulder with a larger diameter faces the in-and-out cam; the longer shoulder has a smaller diameter and faces the E-clip, Fig. D70.

But the early style in-and-out cam has a raised shoulder around the center hole, Fig. D70 (bottom). Because of the raised shoulder on the in-and-out cam, the bushing has only one shoulder—the shoulder that fits through the lever assembly and faces the E-clip. Now it's necessary to modify both the bushing and the in-and-out cam.



FIG. D71 Variation—this is the center of the in-and-out cam in the M85, a single-speed projector. Use the two-shoulder bushing as it's supplied. No modification is necessary.



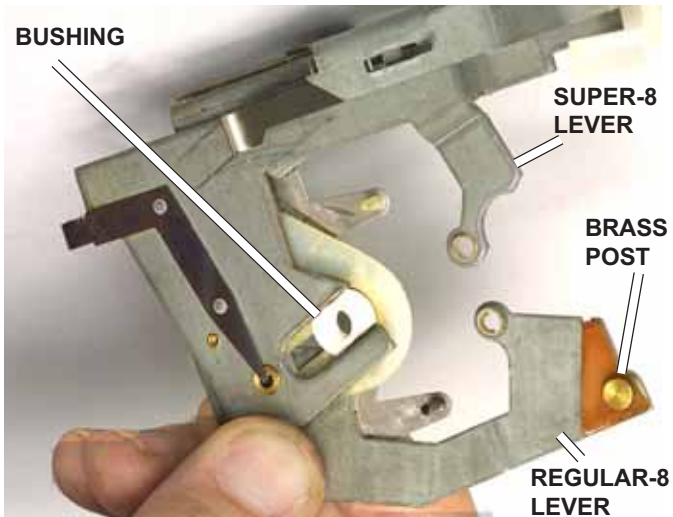

FIG. D72 Front of lever assembly with the new bushing installed. Here you're seeing the longer shoulder on the bushing.

First we'll make the two-step bushing a one-step bushing. In Fig. D74, we've slipped the bushing over a the jaws of a closed hemostat—that's just a convenient way to hold the bushing during the surgery. The shoulder with the larger diameter is facing the tips of the hemostat.

Now use a single-edged razor blade to cut off the shoulder that has the larger diameter (the shoulder that normally faces the in-and-out cam). The modified bushing now has only one shoulder—the longer shoulder that passes through the lever assembly.

Next we'll modify the in-and-out cam. Make sure you understand what you're doing here—you can't get the in-and-out cam as a replacement part.

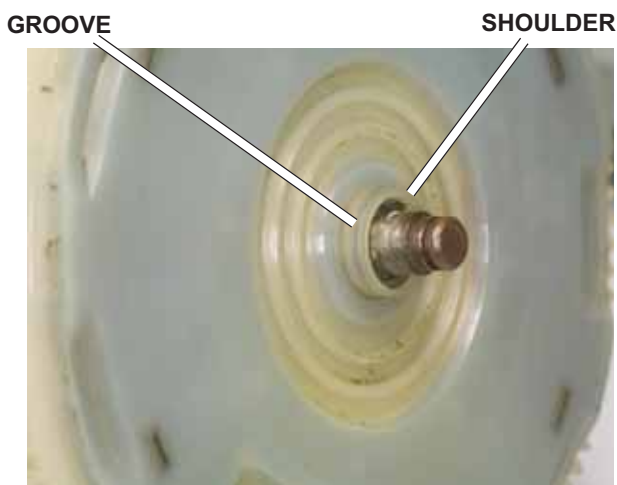

FIG. D75 Early style in-and-out cam.

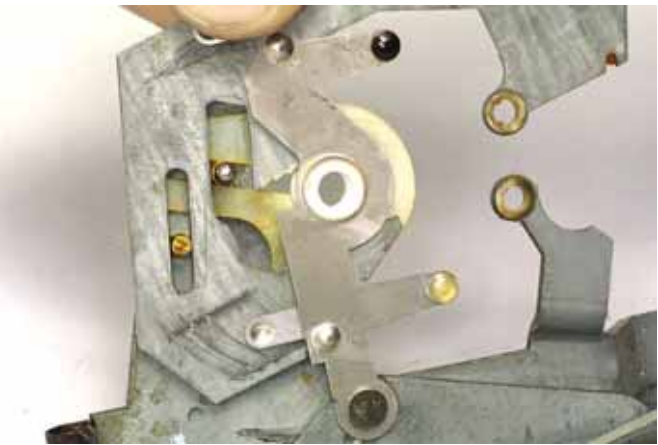

FIG. D73 Back of the lever assembly with the new bushing installed. Insert the bushing from the back as shown here.

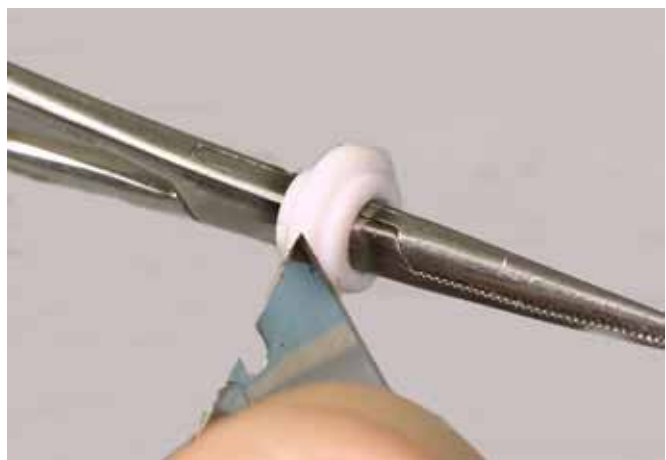

FIG. D74 Cutting off the larger-diameter shoulder of the new-style bushing.



FIG. D76 Modifying the in-and-out cam by cutting back the shoulder to the groove.



Locate the groove around the outer circumference of the shoulder at the center of the in-and-out cam, Fig. D75. Using the single-edge razor blade, cut off the front section of the shoulder—from the end to the groove, Fig. D76.

Even though you've cut off the front of the shoulder, there's still a raised section at the center of the in-and-out cam—the section from the groove to the surface of the in-and-out cam. But you compensated for this difference when you modified the bushing.

Install the modified bushing to the lever assembly as shown in Fig. D72 and Fig. D73. The shoulder passes through the lever assembly from the back, Fig. D73.

Before replacing the lever assembly, clean the front surface of the in-and-out cam, Fig. D75, using the AK225 cleaner. Lubricate the front surface of the in-and-out cam with the *Super Lube* grease. Then seat the lever assembly on the in-and-out cam, Fig. D69. Replace the washer and the E-clip.

INSTALLING AND TIMING THE DRIVE-CAM ASSEMBLY

It's now time to replace the drive-cam assembly in the mechanism. The shutter and shutter-drive shaft have already been installed. As you install the drive-cam assembly, you'll time the in-and-out cam to the shutter. The claw then moves the film while the shutter is closed—and holds the film in place while the shutter is open.

First locate the brass post on the lever assembly, Fig. D77—the lip on the brass post must slip into the keyed slot shown in Fig. D78 and D79. Also note the plastic piece around the brass post, Fig. D77. You may find that the plastic has broken. Or the plastic piece may be completely missing as in Fig. D78. Fortunately, the projector will work properly without the plastic piece.

Slide the drive-cam assembly into the mechanism as shown in Fig. D80. Note the alignment of the brass post on the lever assembly shown also in the close-up photos. Also make sure the slot in the tab on the film-selector slide, Fig. D80, fits over the black arm of the super-8/regular-8 mask.

Fully seat the drive-cam assembly. But before you tighten the spring clamps on the cam shaft, we'll time the in-and-out cam to the shutter.

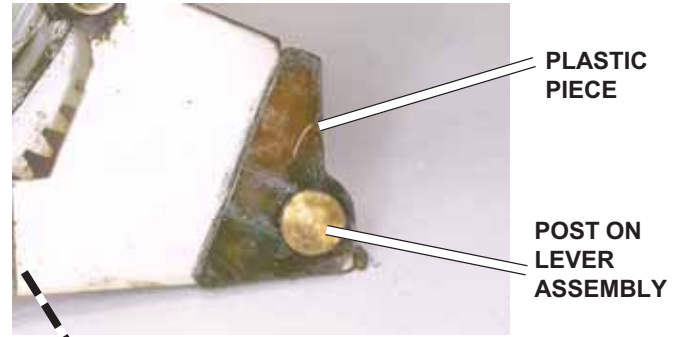

FIG. D77 End of the lever assembly.

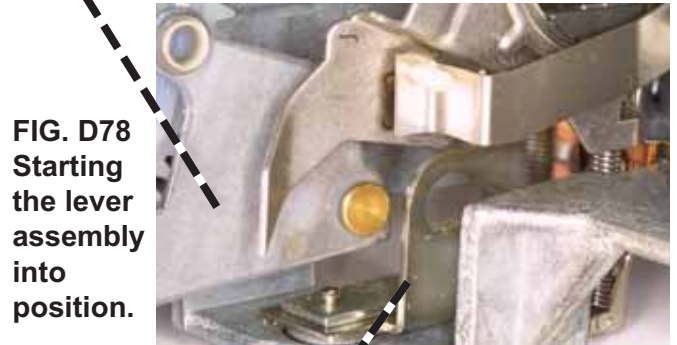

FIG. D78 Starting the lever assembly into position.

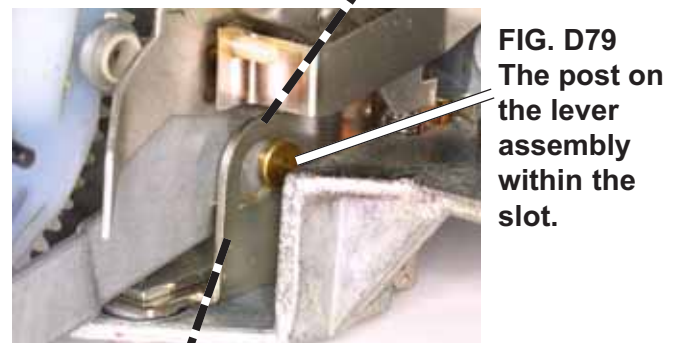

FIG. D79 The post on the lever assembly within the slot.

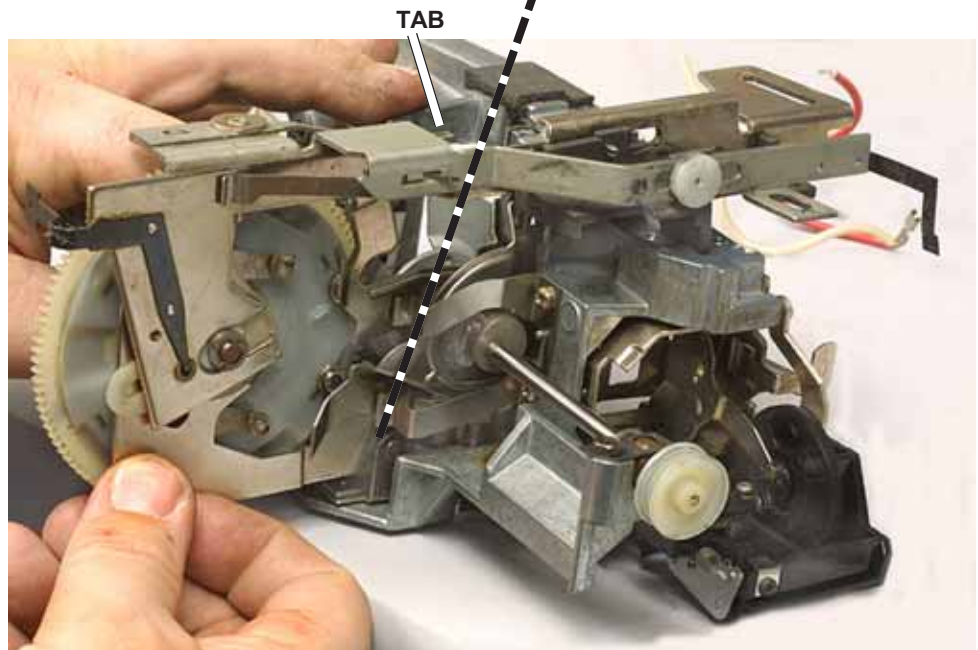

FIG. D80 Installing the drive-cam assembly.



Locate the notch on the outer edge of the shutter (large blade), and the timing mark on the in-and-out cam, Fig. D81. The in-and-out cam may have several timing marks. You can use any of the timing marks on the in-and-out cam. But usually one of the timing marks is highlighted, making it easier to see, Fig. D82.

Shift the in-and-out cam out of engagement with the shutter gear. You can now turn both the in-and-out cam and the shutter gear to change their positions. Re-engage the in-and-out cam with the timing marks aligned as shown in Fig. D82.

Note that the timing mark on the in-and-out can isn't actually within the shutter notch. Rather the timing mark on the in-and-out cam is one tooth clockwise of the shutter notch, Fig. D82. Once you're sure that the timing is correct, tighten the spring clamps over the cam-shaft bearings.

Next replace the nylon followers. Fig. D83 shows one technique. Here we've clamped the follower in a hemostat. We're then using the hemostat to lift the spring arm (the arm with the hole for the follower) and simultaneously sliding the follower into place. As the spring arm returns, the hole passes over the follower.

Remember that it's critical to put the proper follower in the proper position. One follower was individually selected to control the depth of claw engagement for super 8; the other follower was individually selected to control the depth of claw engagement for regular 8. Prior to removing the followers, you'll recall, we marked the super 8 follower (the follower that's closer to the top of the mechanism and a little easier to reach). In Fig. D83, we're installing the super-8 follower at the proper position.

CAUTION: Don't lift the spring arms any further than absolutely necessary. You've seen that the claws run on ball bearings. Lifting the spring arm may cause a ball bearing to fall out.



FIG. D83 Replacing the followers at the front of the in-and-out cam.

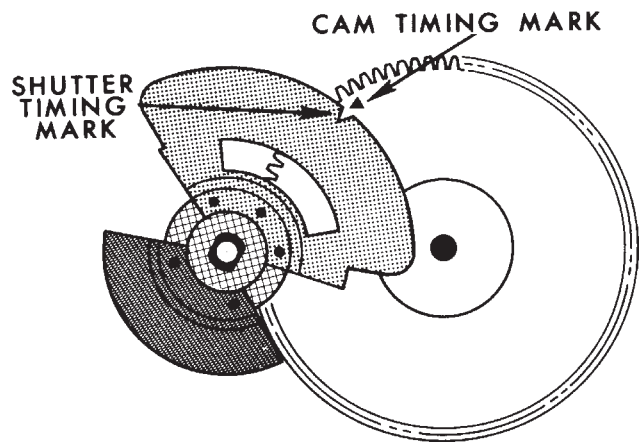

FIG. D81 Timing between the in-and-out cam and the shutter.



FIG. D82 Here the shutter and the in-and-out cam are properly timed.

FIG. D82 Here the shutter and the in-and-out cam are properly timed.

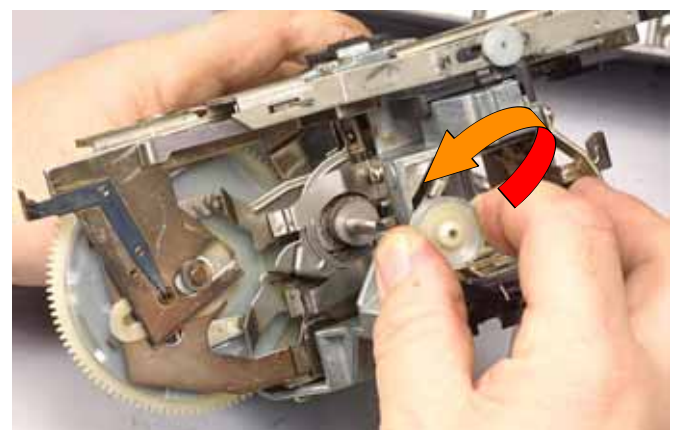

FIG. D84 Check for proper operation by turning the pulley of the shutter-drive shaft counterclockwise.



Once you've installed the two followers, check the operation of the unit. Turn the pulley of the cam shaft in a counter-clockwise direction, Fig. D84. Now the claws should move in and out as well as up and down.

NOTE: While you were working on the mechanism, the mask spring shown in Fig. D85 may have come out. The mask spring operates the regular-8/super-8 changeover mask in the aperture. To replace the spring, remove the still-frame lever, Fig. D87. Fig. D86 shows the spring installed. Use your tweezers—and summon all your patience and dexterity.

REPLACING THE DAMPING ARM

There's one more repair to complete before you replace the mechanism in the housing—replacing the damping arm, Fig. D88. It's quite common for the plastic damping arm to be broken in an old projector. Again, age and humidity make the plastic brittle. You then have the bare spring and roller—and possibly part of the old damping arm, Fig. D89.

The film passes over the damping arm. When you load the film, push down the damping arm until it latches in the down position (the damping arm does not latch with all models).

STILL-FRAME LEVER

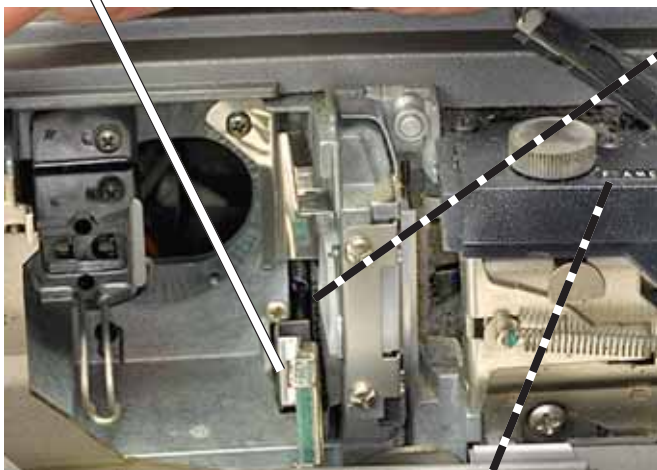

FIG. D87 Front of projector, lamp removed.

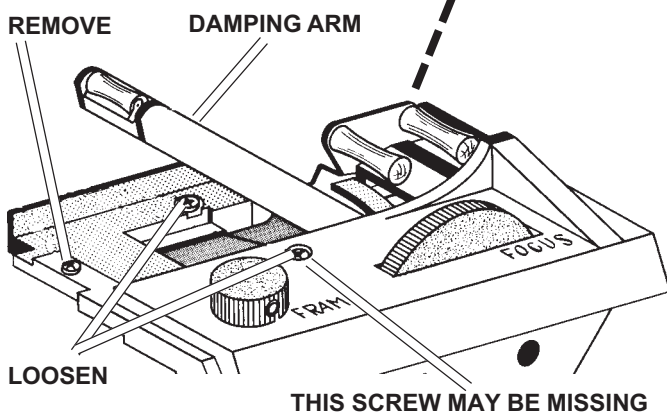

FIG. D88 Damping arm, front of projector.



FIG. D85 Mask spring.

MASK SPRING



FIG. D86 Mask spring installed.

Then, when the film starts running through the projector, the latch holding the damping arm disengages. The damping arm automatically springs up to put spring tension against the film—tension that smooths out (or *dampens*) the film movement through the film gate.

Replacement damping arms are made for the M-series projectors by an independent manufacturer. Keep the spring and roller section of the old damping arm. Just install the new plastic section on the spring/roller section.

We'll first remove the spring/roller section of the old damping arm. Remove the cover screw indicated in Fig. D89. Just loosen the other two cover screws. The projector may



FIG. D89 A broken damping arm viewed from the back of the mechanism.



have only two cover screws; the cover screw shown near the frame knob isn't always used.

Now lift the cover slightly and slide out the old damping arm (from right to left in Fig. D89). The end of the flat spring, Fig. D89, hooks over two lugs under the cover. You can't see the lugs with the cover installed. But you can feel when the flat spring is free.

Remove any sections of the old plastic damping arm. Then install the flat spring into the new damping arm as shown in Fig. D90. The flat spring passes through the slot indicated by the arrow in Fig. D90. The curve in the flat spring then fits around a section at the back of the damping arm. Fig. D91 shows the spring/roller installed on the new damping arm.

Replacing the damping arm in the mechanism requires a little feel to find the hidden lugs. If we had removed the cover, you could see the lugs for the flat spring, Fig. D92. In Fig. D92, the holes in the flat spring are seated over the lugs.

Even though you can't see the lugs with the cover in place, you can feel when the flat spring is properly hooked. Slide the flat spring through the cover slot as indicated by the arrow in Fig. D91. Shift the position of the damping arm, until you can feel the holes in the flat spring clipping over the two hidden lugs. Once you can feel that the flat spring is connected, tighten the cover screw you loosened. Then replace the other screw(s).

Finally turn over the mechanism and locate the latching mechanism for the damping arm, Fig. D94. There are two different types—one using a torsion-type spring, Fig. D94, and one using a coil spring, Fig. D96. If you have the torsion-type spring, the long end of the spring came loose when the damping arm broke or when you replaced the damping arm.

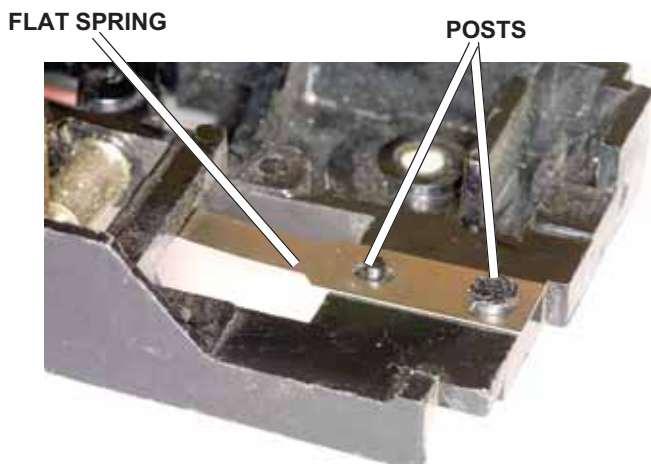

FIG. D92 With the cover removed, you can see how the flat spring seats over a pair of posts.



FIG. D90 Installing the spring/roller unit in the new damping arm.

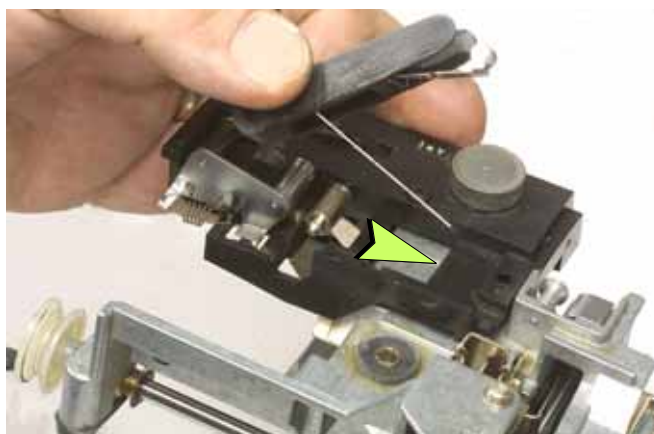

FIG. D91 The damping arm in position for inserting the flat spring through the cover slot.

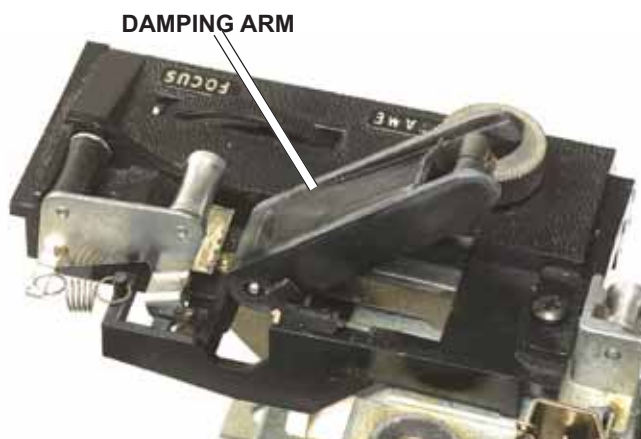
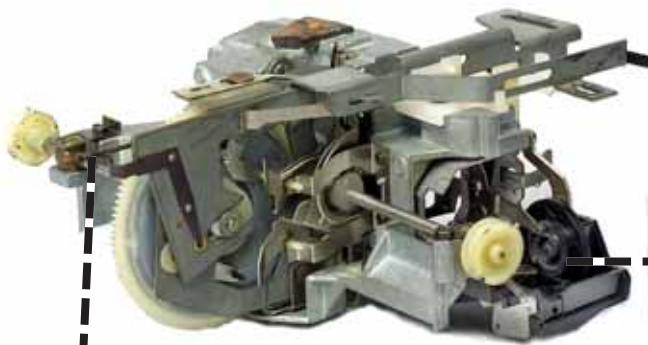

FIG. D93 New damping arm installed.





STILL-FRAME LEVER
 STILL-MASK CHANGEOVER ROD
 SPRING
 SPRING TAB ON SPEED-LEVER ASSEMBLY



FIG. D95 Still-frame changeover rod installed in the mechanism.

SNAP RING

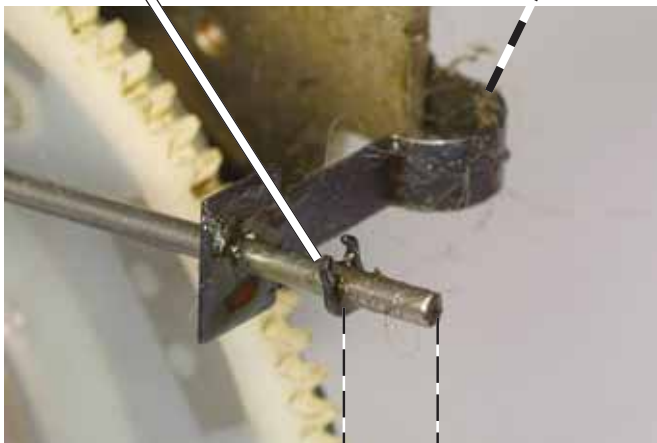

APPROXIMATELY 1/4"

FIG. D97 Initial adjustment of snap ring position on still-frame changeover rod.



FIG. D94 Underside of damping-arm assembly.



FIG. D96 Variation in the latching mechanism for the damping arm. Here the spring does not disconnect when you remove the damping arm.

Fig. D94 shows how the torsion-type spring should be connected. Grasp the long (loose) end of the spring. Turn the long end of the spring in a clockwise direction until you can hook it against the tab (to the left of the tab in Fig. D94).

With all repairs completed on the mechanism, you're now ready to replace the mechanism in the housing.

COMPLETING REASSEMBLY OF THE MECHANISM

1. Replace the still-mask changeover rod, Fig. D95. The still-mask changeover rod passes through the hole in the still-frame lever and through the slot in the spring tab of the speed lever. Replace the snap ring over the end of the still-mask changeover rod, Fig. D97. Remember, the position of the snap ring provides an adjustment. You noted the position prior to removing the snap ring. In most cases, the snap ring is around 1/4" from the end of the still-mask changeover rod, Fig. D97. Replace the spring for the still-mask changeover rod, Fig. D95.



After completing the reassembly, we'll go through the adjustment on the still-mask changeover rod. It's not likely that you'll need to make an adjustment. But you should still check to make sure the adjustment is correct.

TIP: Replace one of the screws in the plastic guide—the screw shown in Fig. D98 (remember, the guide may be either white as in Fig. D98 or black as in Fig. D99). The screw holds the guide in position as you're replacing the mechanism.

2. Seat the mechanism in the case as shown in Fig. D99. First start the right-hand end of the mechanism under the lip in the case. Then seat the left-hand side of the mechanism.
3. Check all points of alignment between the case parts and the mechanism, shown by dashed circles in Fig. D100:

- (1) the slot at the top of the speed lever over the pin on the control knob, Fig. D100
- (2) the slot in the film-selector slide over the post on the cam lever, Fig. D100. Also note the position of the spring tab on top of the film-selector slide in Fig. D100.

The spring on the cam lever, Fig. D101, sometimes pops out of place. Be sure the spring is connected as shown in Fig. D101.

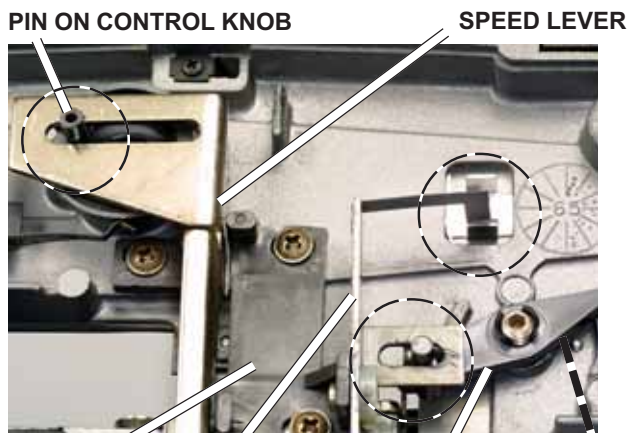

FIG. D100 Mechanism installed in case, points of alignment.

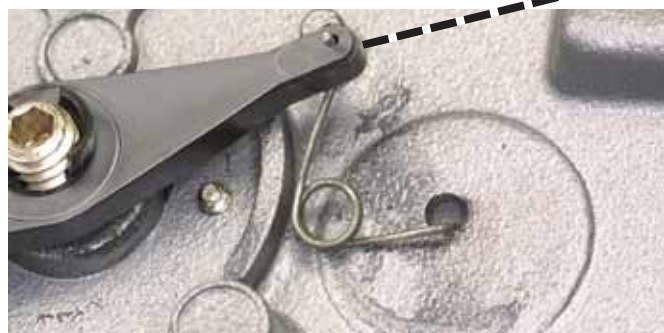

FIG. D101 The spring on the cam lever may jump out of place—here's the proper connection.



FIG. D98 Top of the mechanism, viewed from the back. Here we've replaced one screw to hold the guide.

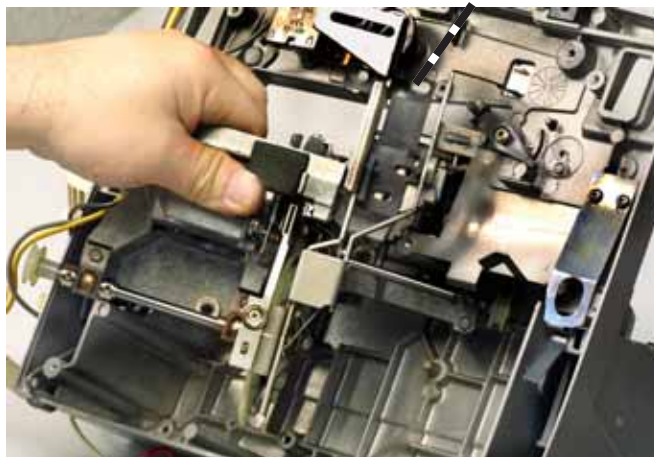

FIG. D99 Starting the mechanism into the case.



FIG. D102 Oil the grommet or the screw; the oil prevents the rubber grommet from turning as you tighten the screw.





FIG. D103 Connecting the belt to the cam-shaft pulley.

4. Replace the three screws holding the mechanism.

TIP: We mentioned earlier that some screws go through rubber grommets. Unless the grommet has a metal washer, it wants to turn or tear. Apply a drop of shutter oil to the screw or to the grommet, Fig. D102 (Fig. D102 shows one of the motor screws). You can then tighten the screw without turning the grommet.

5. Connect the rubber belt to the cam-shaft pulley, Fig. D103.

6. Seat the wirewound resistor, Fig. D106, and replace the long screw (remember, only the projectors using the 120V lamp and having two lamp brightness levels use the resistor).

7. Replace the remaining screws holding the guide, Fig. D106.

8. Replace the lamp leads to the lamp housing, Fig. D104. Remember to first replace the insulator for the lead that has two wires.

RED AND WHITE LEADS

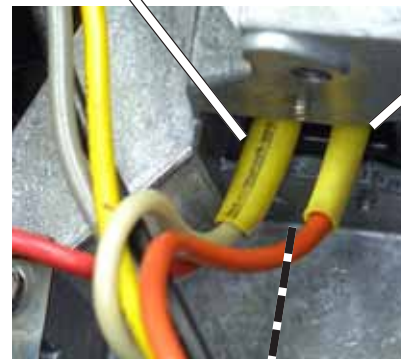

RED LEAD

FIG. D104 Connections to the lamp socket.

PULLEY ON SHUTTER-DRIVE SHAFT

FAN PULLEY

METAL TAB

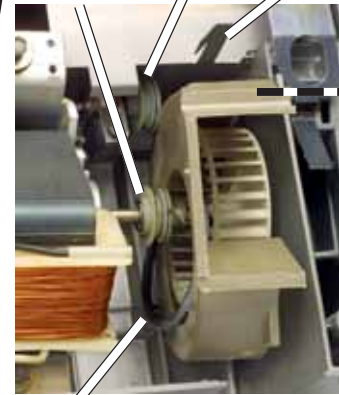

BELT

FIG. D105 Motor installed.

SWITCH

POWER LEADS

WIRE TIE

UPPER WIRE CLIP

WIREWOUND RESISTOR

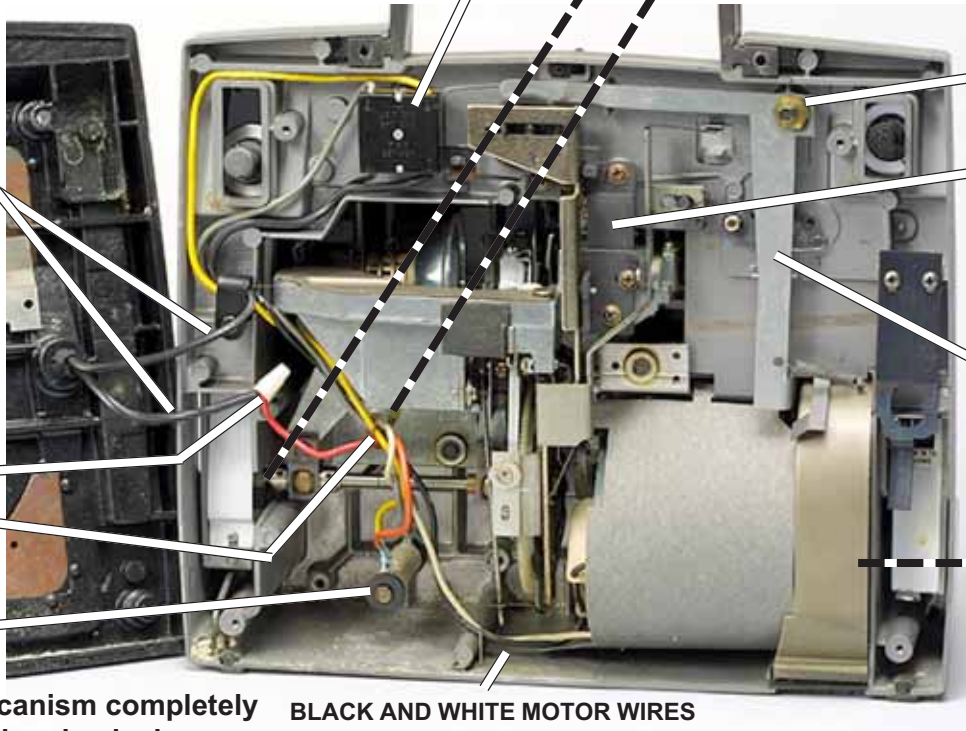

ECCENTRIC

GUIDE

FORWARD/REVERSE ARM

BLACK AND WHITE MOTOR WIRES

FIG. D106 Mechanism completely installed housing, back view.



9. Replace the motor and fan assembly, Fig. D105. Again, use shutter oil on the screws, Fig. D102, to prevent the grommets from turning. Connect the rubber belt, Fig. D105, between the fan pulley and the pulley on the shutter-drive shaft.

SHUTTER CHECK: Pull the rubber belt on the fan pulley slowly toward you. The rubber belt turns the shutter. Check carefully to make sure the shutter does not touch any part of the projector through its 360° rotation. If the clearance isn't sufficient at any point in the rotation, you may have to slightly bend the shutter

9. Turn the fan housing, Fig. D105, to the position shown in Fig. D106. Then bend down the metal tab, Fig. D105, as shown in Fig. D106.

10. Route the white and black motor wires as shown in Fig. D106. Replace the wire clip, Fig. D106.

11. Gather the wires coming from the motor and from the wirewound resistor. Connect the upper wire clip, Fig. D106, to hold the wires.

12. Install the forward/reverse arm, Fig. D106. Turn the eccentric to your scribed position before you tighten the screw. Replace the spring for the forward/reverse arm. Remember the spring-hooking point—the metal tab over the fan cover if the projector uses the short spring, the spring hooking tab if the projector uses the long spring. Fig. D106 shows the long spring connected to the spring-hooking tab.

To check the adjustment on the forward/reverse-arm eccentric, see, *Adjustments #1*. In fact, before connecting the power cord to the projector, it's a good practice to check both the forward/reverse-arm adjustment and the adjustment on the still-mask changeover rod. See *Tests and Adjustments, #1* and *#2*.

We'll now connect the power cord to the projector so we can make the tests and adjustments. Remember, never plug the power cord to a wall outlet until you've replaced the bottom cover.

Both leads of the power cord are black. Route the long lead as shown in Fig. D106—through the clamp to the switch. Insert the bare end of the wire lead into the "L" port of the switch.



FIG. D110 Here's the typical rewind problem—the tabs are broken off the rewind driver.

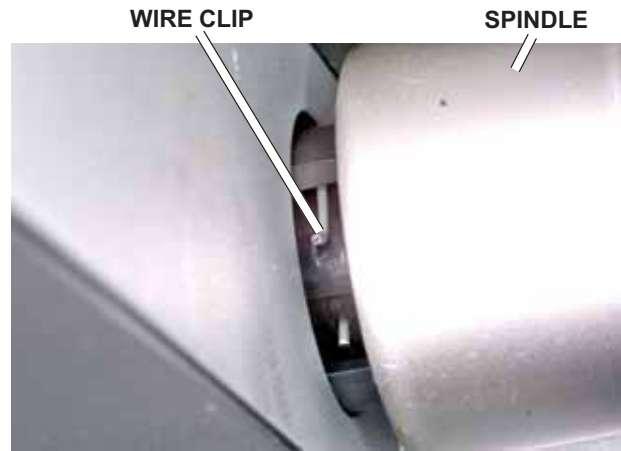

FIG. D107 Side of spindle with the spindle pulled slightly from the projector.

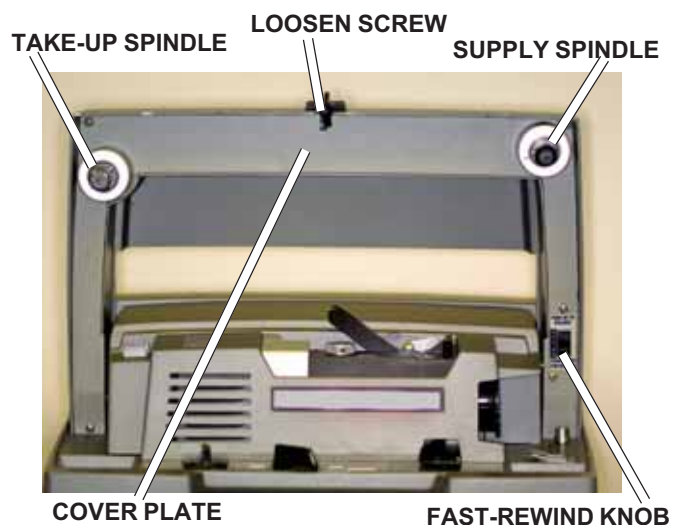

FIG. D108 Front of projector.



FIG. D109 Bottom of spindles.

Hold the short lead of the power cord against the red lead that comes from the lamp socket. The bare ends of the black lead and the red lead should be even with one another. Then install the wire tie, Fig. D106, over the bare ends of the leads. Turn the wire tie in a clockwise direction to twist and hold the wires.

Check the routing of the wires coming from the switch in Fig. D106. Route the wires as shown; the routing prevents the wires from being pinched by the bottom cover.



Seat the bottom cover on the projector. As yet, don't replace the screws—we still have a couple more parts to install at the bottom of the projector. You're now ready to proceed with tests and adjustments. But before we go through the tests and adjustments, there's one more frequent repair we should describe—replacing the rewind driver.

REPLACING THE REWIND DRIVER

The rewind driver turns the take-up spindle for fast rewind. For fast rewind, connect the film from the take-up reel directly to the supply reel—the film does not pass through the gate for the fast rewind. The control shown in Fig. D108 moves the rewind driver into engagement with the supply spindle.

If the customer complains that the film won't fast rewind, the rewind driver may be broken. You can make a quick check by trying to hold the supply spindle, Fig. D108, in the fast-rewind mode. You should not be able to hold the rewind spindle. If you can easily hold the rewind spindle, the rewind driver is broken.

The rewind driver is another part that has been remade for the M80 projector series. To reach the rewind driver, it's necessary to first remove the two spindles, Fig. D108.

Each spindle is by a wire clip or retainer, Fig. D107. Fig. D109 shows the spindles removed so you can see the wire clip. The wire clip engages a slot in a shaft. So, when you pull the wire clip out of the slot, the spindle is free.

Pull the spindle away from the projector until you can see the wire clip, Fig. D107. Then use your spring-hooking tool or a flat screwdriver to pull the bent end of the wire clip toward you (away from the center of the spindle). When the wire clip clears the rod, you can lift off the spindle. Repeat the procedure to remove the other spindle. Note that the two spindles are slightly different. The take-up spindle has a slot in the back to fit the tabs of the take-up pulley, Fig. D111. But the supply spindle has two sets of slots—one to fit the tabs of the supply pulley and another for the tabs of the rewind driver.

With the supply spindle removed, you can see the rewind driver, Fig. D110. The rewind driver in Fig. D110 shows the typical problem—the two lugs that engage the supply spindle for fast rewind have broken off.

You can't as yet remove the rewind driver—it's first necessary to remove the cover plate, Fig. D108. Loosen the screw indicated in Fig. D108; remove the other three screws. Then lift out the cover plate, Fig. D111. Be careful to avoid disturbing the belts, Fig. D111, and the parts below the rewind driver (shown in the drawing of the side view, Fig.

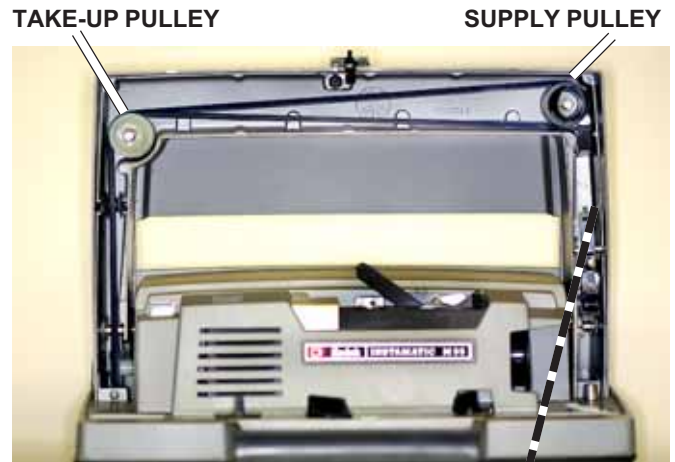

FIG. D111 Front of projector with cover plate removed.

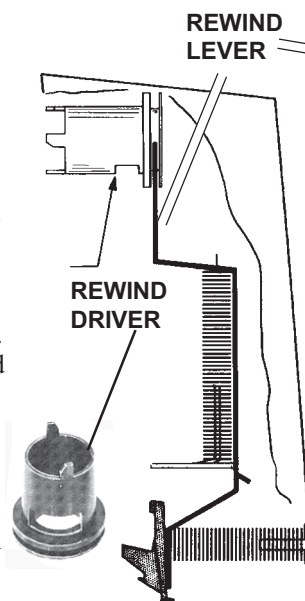

FIG. D112 Projector as viewed from the supply-reel end.



FIG. D113 Mechanism that moves the rewind driver to engage the supply reel.



FIG. D114 Tilt the rewind driver to clear the rewind lever.



D112, and in the photo of the front view, Fig. D113). In most situations, the only reason for removing the cover plate is to replace the rewind driver.

In the drawing, Fig. D112, you can see how the rewind lever fits in the slot at the back of the rewind driver. Tilt the rewind driver slightly, Fig. D114, to clear the rewind lever. Then lift out the rewind driver.

On reassembly, clip the slot at the back of the rewind driver over the rewind lever, Fig. D112. Align the two lugs on the rewind driver on a horizontal line with the two tabs at the front of the pulley, Fig. D111 (in this case, our replacement rewind driver is white in color—the rewind driver we're replacing is black).

Replace the cover plate. Then match the position of the supply spindle with the tabs on the rewind pulley and on the rewind driver—position the slots at the back of the spindle, Fig. D109, on the same horizontal line as the tabs on the rewind driver. Push on the supply spindle until it clicks into place. Follow the same procedure to replace the take-up spindle. But here you need only align one slot—the slot at the back of the take-up spindle with the tabs on the take-up pulley.

TESTS AND ADJUSTMENTS

1. Still-mask changeover rod. Check the position of the still-frame heat-absorbing filter as you turn the speed-control knob. Make sure that...

- at the slowest running speed, the still-frame heat-absorbing filter completely clears the film aperture.
- at still, the still-frame heat-absorbing filter moves into the film aperture.

If the operation of the still-frame lever isn't correct, reposition the snap ring at the end of the still-mask changeover rod, Fig. D112.

- if the still-frame heat-absorbing filter doesn't move

DOG ON SHUTTER-DRIVE SHAFT

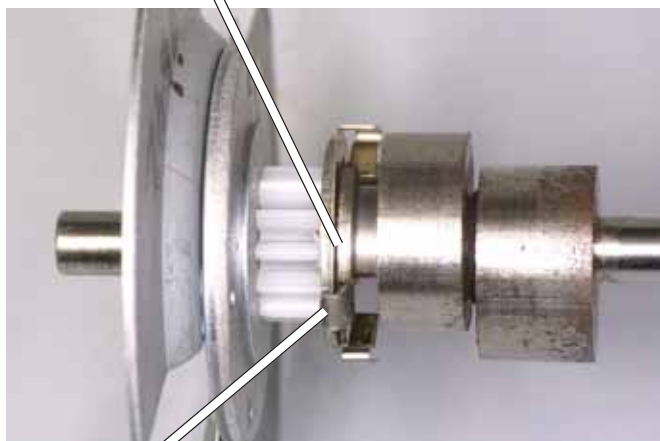

INNER LUG ON SHUTTER

FIG. D113 Shutter-drive shaft and shutter--position at reverse.

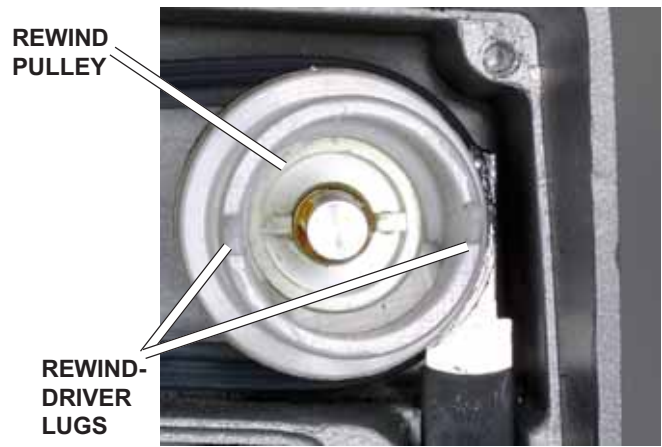

FIG. D111 The replacement rewind driver aligned with the tabs on the rewind pulley.

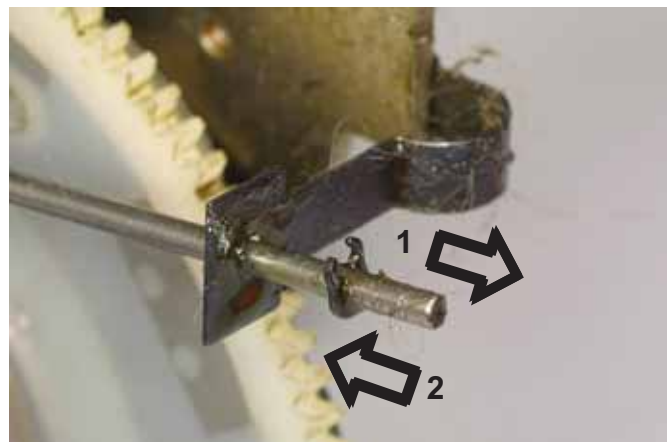
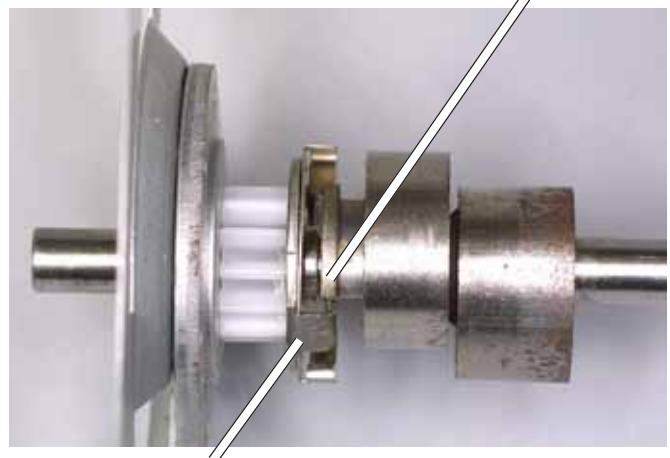

FIG. D112 End of the still-mask changeover rod.

DOG ON SHUTTER-DRIVE SHAFT



OUTER LUG ON SHUTTER

FIG. D114 Shutter-drive shaft and shutter--position at forward.



completely out of the film aperture at the slowest running speed, the snap ring is too far in. Move the snap ring closer to the lower end of the still-mask changeover rod—the direction of arrow #1, Fig. D112.

-if the still-frame heat-absorbing filter doesn't move completely into the film aperture at the still setting, the snap ring is too far out. Increase the distance between the snap ring and the lower end of the still-mask changeover rod—move the snap ring in the direction of arrow #2, Fig. D112.

2. Forward/reverse arm. As you change between forward and reverse, the forward/reverse arm shifts the position of the shutter-drive shaft. The forward/reverse arm pushes the shutter-drive shaft slightly closer to the shutter at the reverse setting. At the forward setting, the forward-reverse arm allows the shutter-drive shaft to move slightly away from the shutter.

The in/out position of the shutter-drive shaft determines which of two lugs on the shutter will be engaged by the drive dog at the end of the shutter-drive shaft. In Fig. D113 and Fig. D114, we've assembled a shutter to the shutter-drive shaft to illustrate the operation.

On reverse, you've seen that the forward/reverse arm pushes the shutter-drive shaft toward the shutter. The dog at the end of the shutter-drive shaft then picks up the inner lug at the back of the shutter, Fig. D113. On forward, the spring-driven shutter-drive shaft moves slightly away from the shutter. The dog at the end of the shutter-drive shaft then picks up the outer lug at the back of the shutter, Fig. D114.

Watch the shutter-drive shaft as you shift the projector between forward and reverse—make sure the dog on the shutter-drive shaft engages the proper lug on the shutter. If the shutter-drive shaft won't move back far enough to engage the outer lug on the shutter, adjust the eccentric on the forward/reverse arm, Fig. D116. Similarly, adjust the eccentric if the shutter-drive shaft won't move in far enough to engage the inner lug on the shutter. But first make sure that the shutter-drive shaft is free to move in. If one of the springs at the back of the shutter is bent, it may be blocking the shutter-drive shaft, Fig. D115.

3. Testing film advance. For safety, always install the bottom cover before plugging in the projector. If you've just repaired the projector, it's not as necessary as yet to replace the bottom-cover screws—just make sure the bottom cover is in place.

Next install the lamp and the film-path cover plate. Also replace the pressure plate, Fig. D117, and the lens; it's not necessary to replace the front cover for tests and adjustments. You can now check the projector with test film. If you're repairing the projector for someone else, **always use test film**—don't risk damage to the customer's film.

When you're checking with super 8 film, install the super-8 adapter over the supply spindle. Remove the super-8 adapter to check with regular-8 film.

BENT SPRING BLOCKING SHUTTER-DRIVE SHAFT

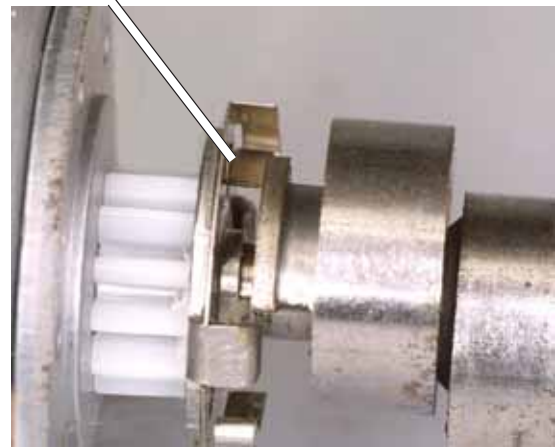

FIG. D115 Shutter-drive shaft and shutter—here a bent spring at the back of the shutter is preventing the shutter-drive shaft from moving to the reverse position.

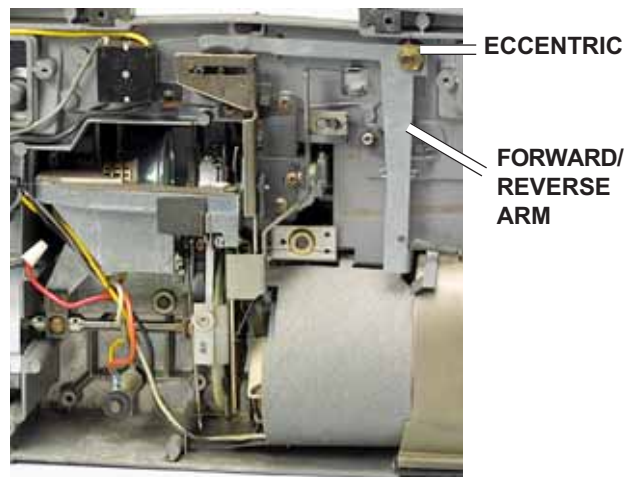

FIG. D116 Back of projector.

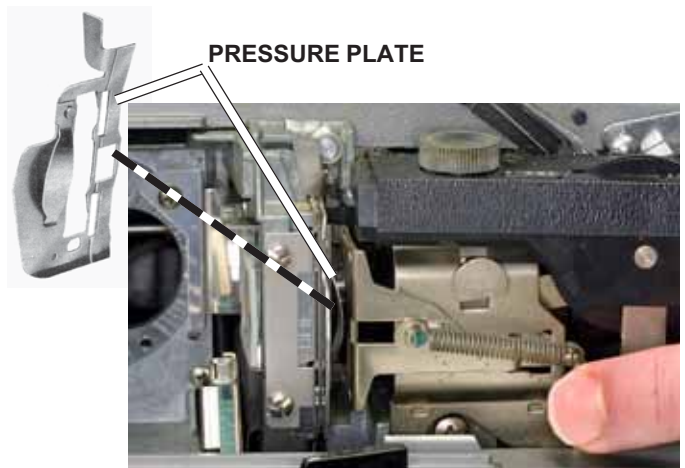

FIG. D117 Front of projector—pressure plate installed.





FIG. D118 M80 projector transporting film.

Bring the film from the supply reel across the damping arm. Push down the damping arm until it latches. Then feed the film through the top of the gate. When you turn on the projector, the film should advance through the gate and automatically wrap around the take-up reel. The damping arm should disengage and move up, providing a loop of film. Fig. D118 shows the film path through the projector.

Turn on the lamp and check the projected image. Can you detect any jumping in the image? You can more easily detect jumping by turning the frame control until you can see the line between the frames. The line should appear steady without jumping.

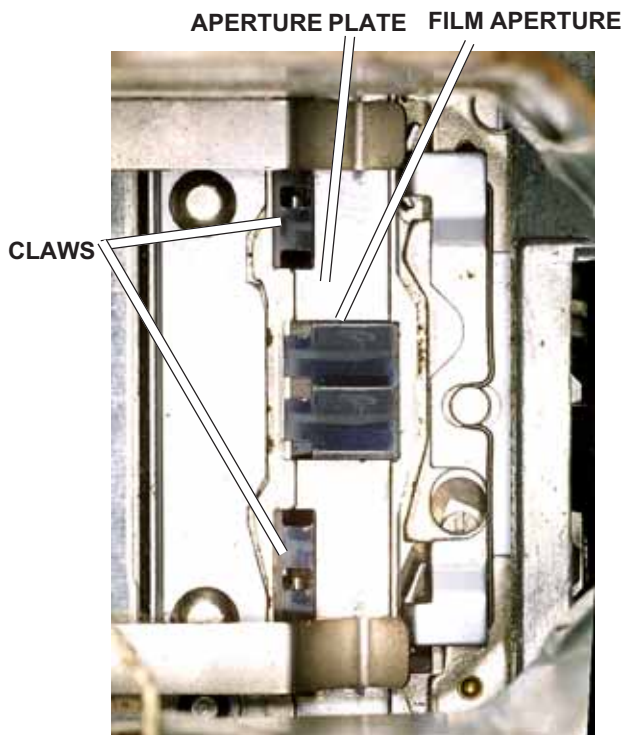

FIG. D121 View through the lens opening, lens removed.



FIG. D119 Cleaning the supply spindle.

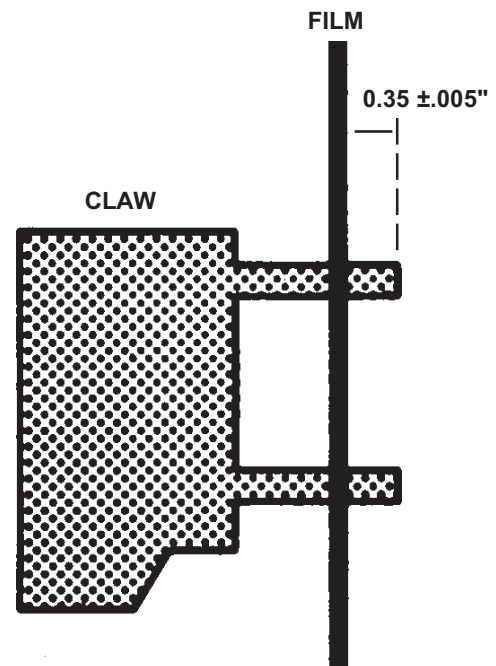

FIG. D120 Side view of the claw engaging the film.

If the image does jump, there are a couple of possible problems. Does the image jump just on super 8? Or just on regular 8? If the image jumps on one but not the other, you may have to adjust the claw engagement (see the following topic). But if the image jumps on both regular 8 and on super 8, the problem may be dirt in the spindle.

You might try drawing some film from the supply reel to see if the jumping stops—that way, the film moves through the gate without being held back by jerky movement in the supply spindle. If the jumping does stop, try cleaning the spindle. As the projector is running, spray the cleaner/degreaser into the spindle as shown in Fig. D119. Hold the spindle while you're spraying in the solution. Then use your compressed air to blow out the cleaner.

Also check image while running the projector in reverse. Again, the image should not jump. If the image does jump,



clean the take-up spindle just as you cleaned the supply spindle.

3. Claw engagement. If the image jumps—or if the film fails to move through the gate—it may be necessary to adjust the depth of claw engagement. You can visually check the claw engagement by looking through the lens opening while transporting a roll of test film, Fig. D121. Proper claw engagement— $0.35 \pm .005$ ". The specification gives you an idea for visually judging the engagement—or you can make the special gauge suggested by Kodak (see, *Operation and Repair Tips from Kodak*). For a quick test while running film, pull up on the film before it passes through the gate—if you can pull the film out of the gate, the depth of claw engagement is insufficient. Check both with super 8 and with regular 8.

Remember that the M80 projector uses different followers for super 8 and regular 8. The followers come in different lengths to adjust the claw engagement. Here's the rule:

**To increase the depth of engagement,
use a shorter follower.
To decrease the depth of engagement,
use a longer follower.**

To remove the follower, unplug the projector and then remove the bottom cover. Locate the in-and-out cam, Fig. D122. You can then find the two followers on the motor side of the in-and-out cam—they aren't as easy to reach as when you had the drive-cam assembly removed, but you can still get to the followers.

As you're looking from the bottom of the projector, Fig. D122, the super-8 follower is closer to the bottom of the mechanism—it's the follower that's easier to reach. The regular-8 follower is further in; it's more difficult to reach.

Use your hemostats to grasp the followers. Clamp the hemostat on the follower you want to remove. Then use your probe to lift the arm slightly. Remember—don't lift the arm too far. Lifting the arm too far may allow one of the claw ball bearings to fall out; it's then necessary to disassemble the mechanism to replace the ball bearing. As you lift the arm, slide the follower out of its hole.

Now use your caliper to measure the length of the follower. To make the adjustment, you probably need the bullet that's one size longer (if the claw engagement is too deep) or one size shorter (if the claw engagement is insufficient).

Here are the lengths of available followers for the M80:

0.220" (part #176652)
0.225" (part #176653)
0.230" (part #176654)
0.235" (part #176655)
0.240" (part #176656)
0.245" (part #178373)
0.250" (part #178374)

REACH FOLLOWERS THROUGH HERE

BAFFLE

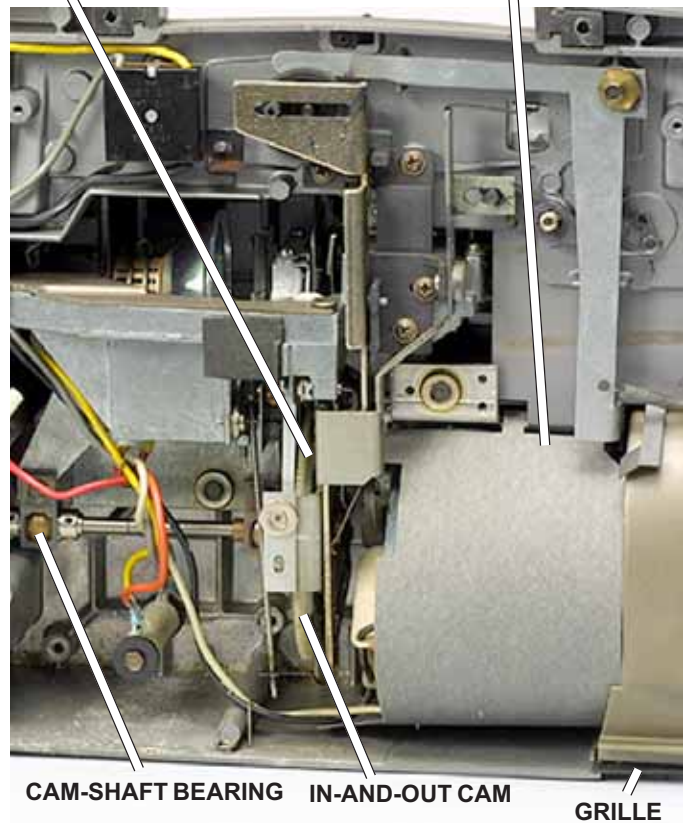

FIG. D122 Back of projector.

Suppose, for example, that you have insufficient claw engagement with super-8 film. You then know you need a shorter follower. Let's say the old super-8 follower measures 0.230". In that case, you might try the 0.225" follower. If the claw engagement is still insufficient, try the 0.220" follower.

Clamp the new follower in your hemostat. Again lift the arm slightly with your probe—just enough to slide in the new follower.

Fortunately, you'll rarely have to change the followers. If you do need a shorter follower, you can always file a little off the flat side. But if you need a longer follower, order one according to the part number.

VARIATION: If you're working on a model that just runs super 8, there's only one follower. The follower is a little different in shape (rather than looking like a bullet, it looks more like a shift knob, Fig. D123), but the adjustment is the same. Here are the followers for the M90 and M70:

0.202" (part #177640)
0.207" (part #176835)
0.212" (part #177641)
0.217" (part #177642)
0.222" (part #177643)
0.227" (part #177644)
0.232" (part #177645)



Changing the followers provides a very precise *fine* adjustment for the depth of claw engagement. There is one other way to adjust the claw engagement—a rough adjustment. You can loosen the restricting collars, one on each side of the cam-shaft bearing, Fig. D122. Then shift the cam-shaft bearing to move the complete in-and-out cam—closer to or further from the claw. However, it's difficult to position the in-and-out cam with great precision.

At times, though, you may find that the claw engagement is so shallow that the film won't advance through the gate. The reels turn, but the claw can't grab the film. You may then have to adjust the bearing on the cam shaft until the claw engages the film. Then use the followers for the fine adjustment to eliminate jumping in the image.

FINAL STEPS OF REASSEMBLY

Once you're satisfied with the operation, again unplug the projector. Remove the bottom cover. Now slip in the grille and replace the baffle, Fig. D122. Seat the bottom cover and replace the screws. Finally, snap the front cover into place.

If the projector takes both super 8 and regular 8, remember to replace the super-8 adapter over the supply spindle. Also, before you return the projector to a customer, set the control to super 8 (most people use super 8 rather than regular 8).

TROUBLESHOOTING SUMMARY

Malfunction: Film does not transport, even though motor runs.

Likely cause: Shutter gear broken.

Solution: Replace shutter.

Malfunction: Image jumps.

Likely cause 1: Spindles dirty.

Solution: Clean spindles.

Likely cause 2: Insufficient claw engagement.

Solution: Adjust claw engagement.

Likely cause 3: Incorrect claw timing.

Solution: Time shutter cam.

Malfunction: Spindles turn, but the film won't move through the gate.

Likely cause: Insufficient claw engagement.

Solution: Adjust claw engagement.

Malfunction: Supply reel doesn't turn on rapid rewind.

Likely cause: Rewind driver broken.

Solution: Replace rewind driver.

Malfunction: It's difficult to shift between the running speeds.

Likely cause: Bushing on cam shaft damaged.

Solution: Replace the bushing.

Malfunction: Still-frame heat-absorbing filter remains in the light path on the slowest running speed (6fps).



FIG. D123 A projector that runs only super 8 uses the knob-like follower on the left. A projector that runs both super-8 film and regular-8 film uses two of the bullet-shaped followers on the right. Both types come in different lengths for adjustment.

Likely cause: Snap-ring position on still-mask changeover rod.

Solution: Adjust snap-ring position.

Malfunction: Still-frame heat-absorbing filter does not move fully into light path at the still-frame setting.

Likely cause: Snap-ring position on still-mask changeover rod.

Solution: Adjust snap-ring position.

Malfunction: Shutter does not turn, even though the shutter-drive shaft turns.

Likely cause: Adjustment on forward/reverse arm.

Solution: Adjust forward-reverse-arm eccentric.

Malfunction: Shutter does not turn when you operate the projector in reverse.

Likely cause: Adjustment on forward/reverse arm.

Solution: Adjust forward-reverse-arm eccentric.

Malfunction: Excessive noise.

Likely cause: Shutter blade hitting other parts of the projector.

Solution: Bend the shutter blade for clearance.

Malfunction: Lamp does not turn on.

Likely cause 1: Lamp burned out.

Solution: Replace the lamp.

Likely cause 2: Connections to lamp.

Solution: Check the wire connections to the lamp.

Other possible causes include a defective switch, but switch failure is unusual.

Malfunction: Motor does not run.

Likely cause 1: Connection between power cord and switch or between power cord and motor.

Solution: Check, clean, and improve the connections.



WIRING PICTORIALS

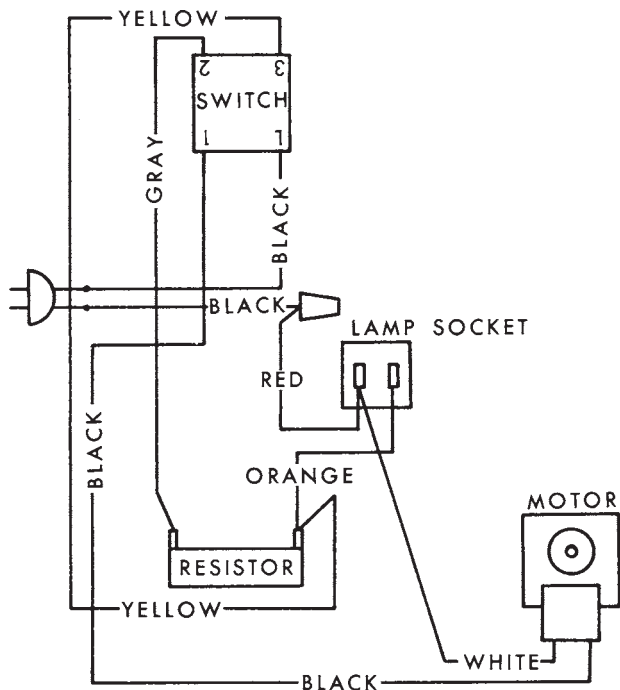

M80

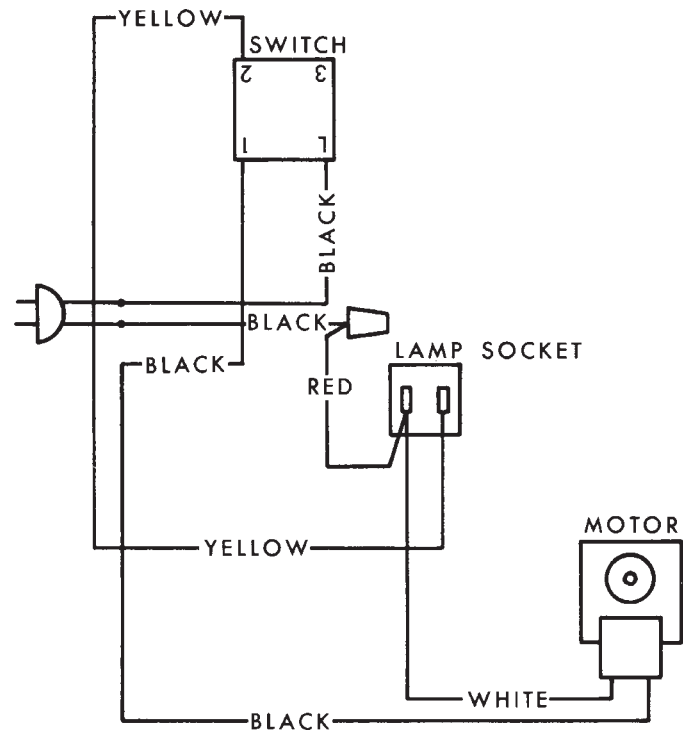

M85

Likely cause 2: Connection between motor white wire and lamp socket.

Solution: Check, clean, and improve the connection.

Other possible causes include a defective switch or a defective motor. However, these causes are unlikely.

LUBRICATION SUMMARY

Grease lubrication:

- up-and-down cams on the shutter-drive shaft
- surfaces of claw levers that ride against in-and-out cam followers
- front surface of in-and-out cam

Oil lubrication:

- ball bearings on claw assembly
- shutter drive shaft (where the shutter-drive shaft passes through the bearings)
- cam shaft (where the cam shaft passes through the bearings)

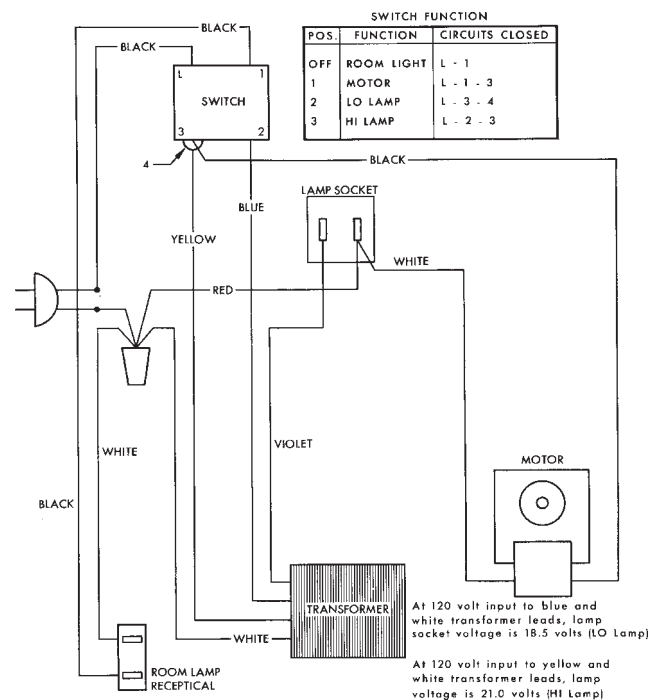

M95



M80 OPERATION & SPECS FROM KODAK

The Kodak service manuals provide good background information in the operation of the M-series projectors. Since you can no longer obtain all of the special tools described, we have edited the following section of Kodak's M80 service manual.

1. TOOLS, SPECIFICATIONS

Useful Service Tools

A suitable pull-down claw protrusion gauge can be made as shown in Fig. K1.

Electrical

110 - 125 volt, 60 cycle, AC only; shaded pole induction motor.

Projection lamp

M70, M80, M85—150 watt, 120V, ASA Code DNE
M90, M95—150 watt, 21 volt, ASA Code DNF

Projection Lenses

KODAK Projection Ektanar, 28mm, f/1.5
KODAK Projection Zoom Lens, 20-32mm, f/1.5
KODAK Projection Ektanar, 22mm, f/1.5
KODAK Projection Ektar, 28mm, f/1.0

Serial Number

The serial number is located on a plate by the film cutter.

2. OPERATION

Operation of the M80 will be described. Operation of the M85 and M95 will be covered by applicable notes as the description proceeds.

Pulldown System

The M80 and M95 projectors have a skip-frame pulldown system that results in flickerless projection at 6, 18 (*Normal*), and 54 frames per second in *Forward* or *Reverse*. The M85 operates only at 18fps in both *Forward* and *Reverse*.

To accommodate the two films (regular 8 and super 8), there are two claws mounted on opposite sides of the same claw post assembly, Fig. K2.

A single-blade shutter assembly, mounted on the shutter-drive shaft but free to rotate relative to it, is driven by a dog on the up-and-down cam. The shutter assembly includes a pinion which engages the teeth of the in-and-out cam.

The shutter-drive shaft is belt-driven from a motor at a constant speed of 54rps, and the pulldown claws are moved up and down at this rate by cams fastened to the shutter shaft, Fig. K2.

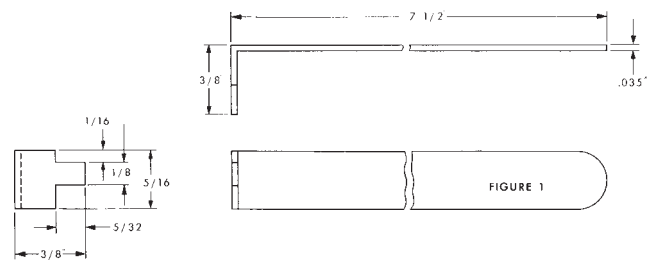

FIG. K1

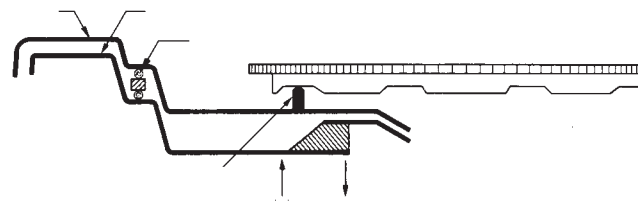

FIG. K2

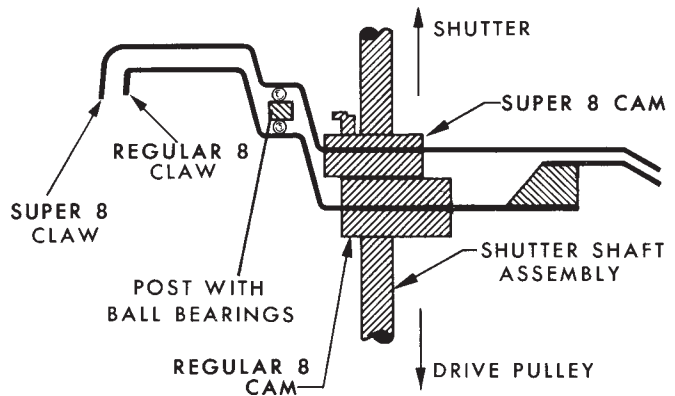

FIG. K3

The cam that is used as a counterbalance in the CARALUX, M70, and M90 is put to work in the M80, M85, and M95. The super-8 claw rides on the first cam, and the regular-8 claw on the counterbalance cam.

NOTE: As the cam shaft rotates counterclockwise, the super 8 and regular 8 claws move in opposite directions relative to each other. As the super-8 claw strokes UP, the regular-8 claw strokes DOWN, Fig. K4.

The single in-and-out cam is driven by the pinion of the shutter assembly at 9:1 reduction and operates at a constant 6 rps.

This cam has 9 equally spaced depressions on its surface; one extends nearer to the center than the others, two extend an intermediate distance, and the other 6 a shorter distance, Fig. K5. *The M85 cam has only 3 equally spaced depressions, all the same length.*



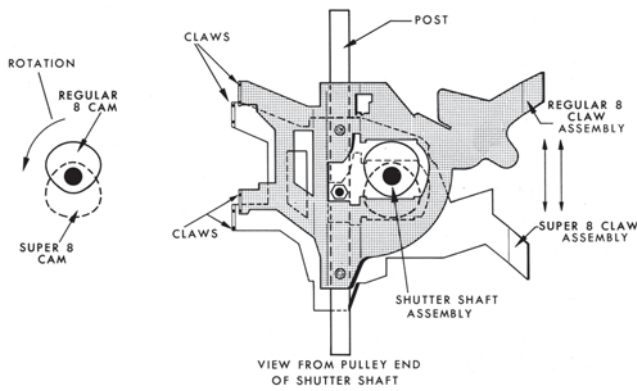

FIG. K4

Two movable cam followers (one for each claw) are located conventionally between the claw and the in-and-out cam, Fig. K6. Both are in constant contact with the cam and both are positioned by a speed-shift lever so that they follow one of 4 tracks on the face of the cam. There are only 2 tracks on the M85 cam.

In position #1, Fig. K5, regardless of which claw is "working," the projector is in "still" because the follower does not drop in any of the detents as the in-and-out cam rotates.

Position #2 gives 6 frames per second because the follower drops in only the longest detent, once per revolution of the 6rps in-and-out cam.

$$6\text{rps} \times 1 \text{ detent} = 6 \text{ frames per second}$$

Position #3 gives 18fps because the follower drops in the 2 intermediate detents, plus the longest detent, on each revolution of the cam.

$$6\text{rps} \times 3 \text{ detents} = 18 \text{ frames per second}$$

Position #4 gives 54fps because the follower drops in the 6 short detents, in addition to the 2 intermediate detents and the 1 long detent, on each revolution of the cam.

$$6\text{rps} \times 9 \text{ detents} = 54 \text{ frames per second}$$

The M85 has positions #1 and #3 only.

This operation can be observed by removing the base and rotating the shutter shaft by hand. To prevent damage to the mechanism, the shaft must be rotated counterclockwise only. Or use a strobe lamp set at a slightly lower rate than necessary to "stop" the motion.

Film Selector

The selector knob, Fig. K7, determines whether the super-8 claw or the regular-8 claw is in the operating position. One window in the control panel plate indicates which film (super 8 or regular 8) the projector is ready to accept. The two remaining windows indicate *Forward* and *Reverse* settings of the speed-control knob.

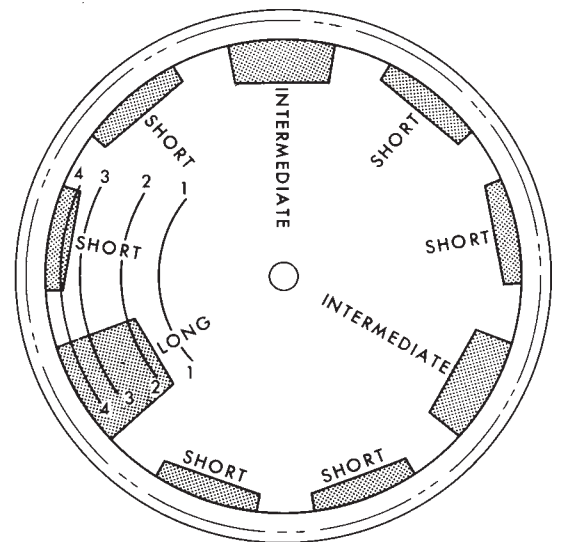

IN-AND-OUT CAM

FIG. K5

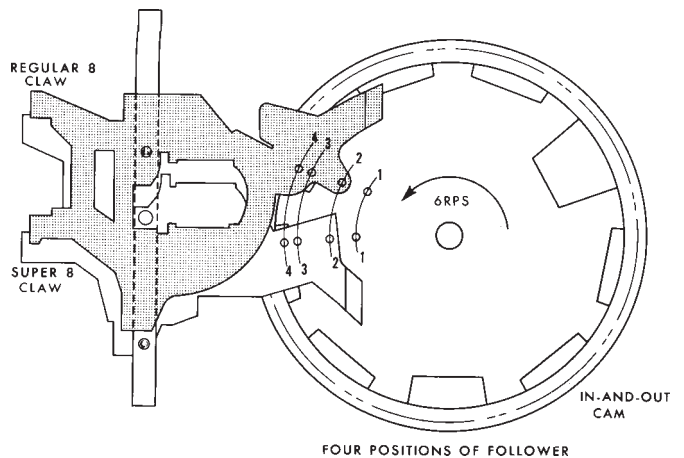

FOUR POSITIONS OF FOLLOWER

FIG. K6

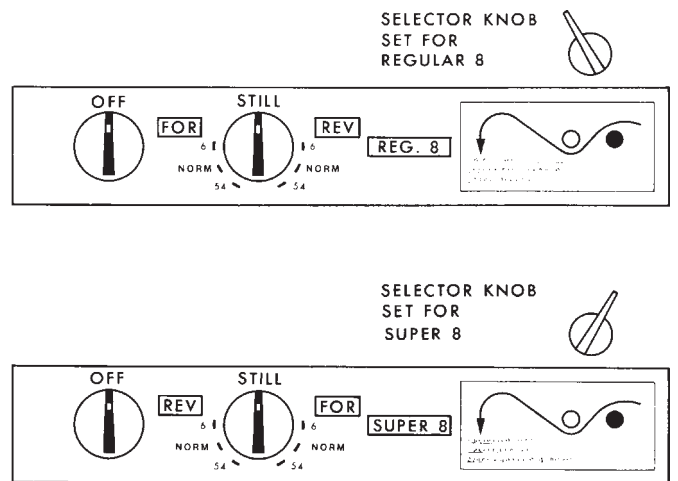

FIG. K7



Switching from regular 8 to super 8 changes the required direction for rotating the speed-control knob to obtain *Forward* or *Reverse* operation, Fig. K7. Observe *For* and *Rev* change on the control panel.

When the selector knob is set for regular-8 film, the regular-8 claw is in contact with the regular-8 follower, which is riding on the in-and-out cam surface. The follower may be set for 54, 18, or 6fps or "Still." In the M85, the follower can be set for 18fps or "Still." The follower imparts the in-and-out motion to the claw in the film perforations.

All this time, the super-8 claw arm is being held up and away from its follower by a nylon spacer on the toggle, Fig. 8. The follower will be riding on the in-and-out cam surface, but will not impart any in-and-out motion to the claw. The claw will still go up-and-down, but will not go in-and-out to engage film perforations.

In Fig. K9, note the direction of claw movement in the regular-8 claw. It engages the perforations in regular-8 film at the top of the stroke, moves the film down, disengages the perforations, and returns to the top of the stroke again. The super-8 claw cycles in the opposite direction, but does not engage film perforations. If there is any in-and-out movement, it is very shallow.

When the selector knob is set for super 8, the selector lever has moved the toggle counterclockwise. This moves the other nylon spacer under the regular 8 claw arm, raising it up and out of contact with its follower. At the same time, the nylon spacer under the super-8 claw arm is withdrawn, allowing the super-8 claw arm to contact its follower. This act moves the regular-8 claw out of the film perforations and moves the super-8 claw into position to pull super-8 film, Fig. K10.

In reverse, Fig. K9, the ENGAGED claw enters the film at the BOTTOM of its stroke, moves up, disengages the film perforations, and moves down. Again the disengaged claw never touches the film.

Spindle Operation

Both spindles are driven by a single belt and revolve in a "take-up" direction when the projector is running, and a fairly low constant tension is maintained by the clutches. Since the projector is sprocketless and the tension of both spindles is about the same, film will automatically take up on whichever reel the claw moves the film toward.

Rewind Operation

The rewind spindle (front) has a certain amount of slippage which is necessary for proper operation. When the rewind switch is moved to the "On" position, the front spindle is driven by a pin which prevents slippage, thereby rewinding the film.

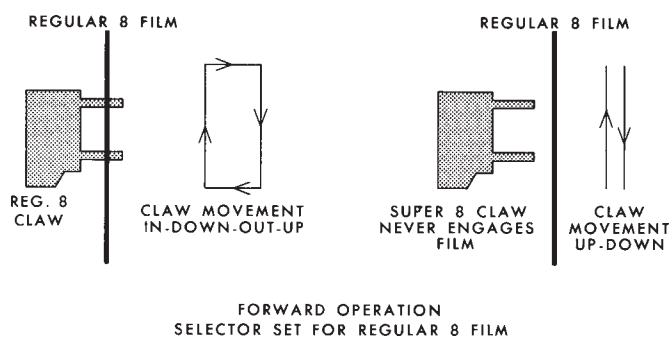

FIG. K8

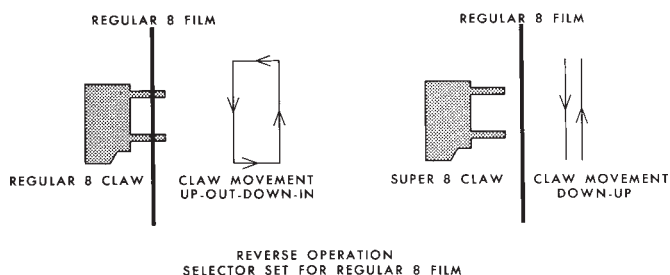

FIG. K9

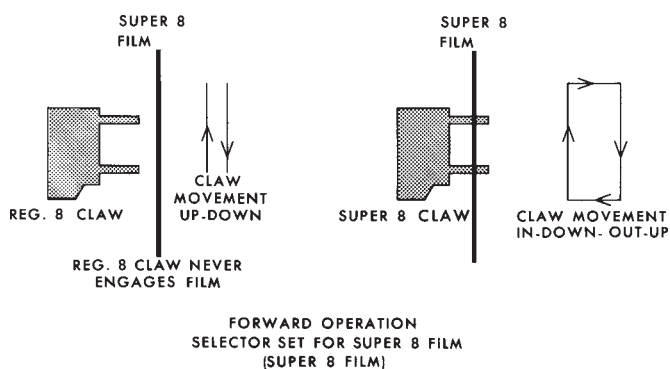

FIG. K10

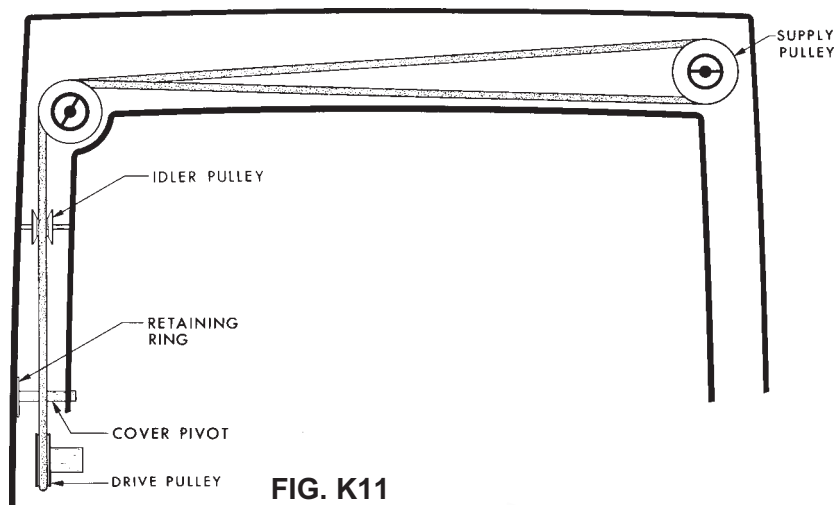

FIG. K11



Direction of Shifting Operation

Because the motor turns the shutter-drive shaft in the same direction at a constant 54rps at all times, shifting from forward to reverse involves changing the phasing between the up-and-down cam (on the shutter-drive shaft) and the in-and-out cam (driven by the shutter). Remember that the shutter and the shutter-drive shaft can rotate and slide relative to each other.

In the super-8 *Forward* running position, the cam dog drives the long shutter lug (Fig. K12 and Fig. K15) and the pulldown claw enters the film perforations at the start of the down stroke.

Shifting direction: the directional shift lever pushes against the shutter-drive shaft and moves it and the drive dog to the left, Fig. K13, closer to the shutter and pinion assembly.

The cam-drive dog is now disengaged (Fig. K13 and Fig. K16) from the shutter assembly and is free to rotate relative to it.

The cam-drive dog rotates 180° until it reaches the short shutter lug, Fig. K14 and Fig. K18. This is the super 8 *Reverse* running position. The pulldown claw enters the film perforations at the start of the upstroke.

To change direction again, the directional shift lever releases the shutter shaft, and a spring moves the shutter-drive shaft and drive dog back to the right; the cam-drive dog is free to rotate 180° until it again engages the long lug and this again is the super-8 *Forward* running position.

In the regular-8 *Reverse* running position, the cam dog drives the long shutter lug, Fig. K12 and Fig. K15, and the pulldown claw enters the film perforations at the start of the upstroke, Fig. K11.

Shifting direction: the directional shift lever pushes against the shutter-drive shaft and drive dog and moves it to the left.

The cam-drive dog is now disengaged, Fig. K13 and Fig. K17, from the shutter assembly and is free to rotate relative to it.

The cam-drive dog rotates 180° until it reaches the short shutter lug, Fig. K14 and Fig. K18. This is the regular-8 *Forward* running position. The pulldown claw enters the film perforations at the start of the downstroke.

To change direction again, the directional shift lever releases the shutter-drive shaft and drive dog, and a spring moves the shutter-drive shaft back to its original position; the cam-drive dog is free to rotate 180° until it again engages the long lug and this again is the regular-8 *Reverse* running position.

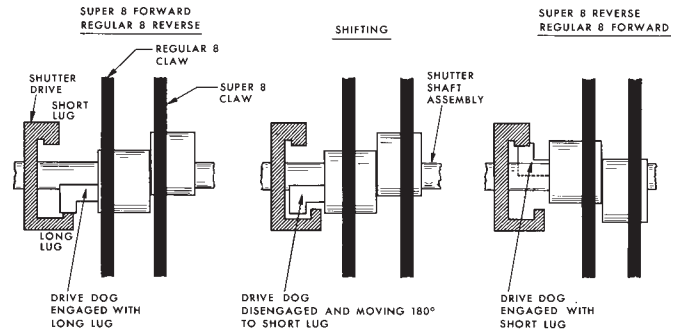

FIG. K12

FIG. K13

FIG. K14

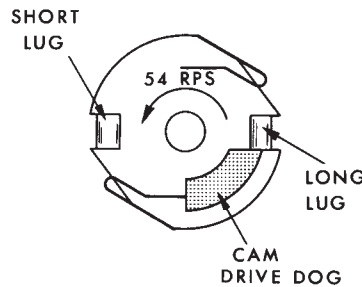

FIG. K15

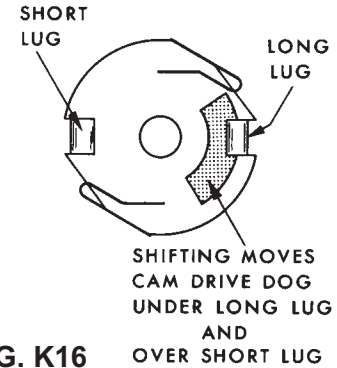

FIG. K16

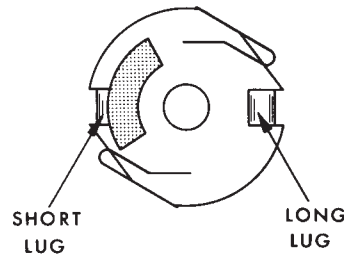

FIG. K17

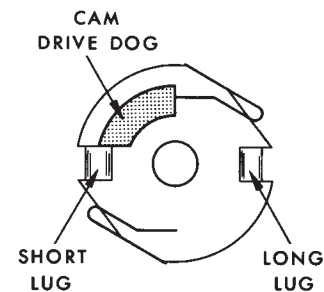

FIG. K18



NORMAL REPAIRS IN THE KODAK MOVIEDECK PROJECTORS

Another popular series of Kodak projectors—the Moviedeck series—still has widespread use. Even after years of service, there are very few problems with the Moviedeck projectors.

As with the M-series projectors, the shutter gear breaks and/or deteriorates. The symptom is then the same as with the M-series—the projector won't transport film. Fargo Enterprises, Inc. also rebuilds the Moviedeck shutters.

Another shutter used in some Moviedeck projectors has a metal gear rather than a plastic gear. You can't get the shutter with the metal gear. But that's no problem—the shutter with the metal gear never seems to need replacement.

In all, there are probably only three malfunctions you'll encounter in the Moviedeck projectors. And there are only two symptoms of the three malfunctions:

1. The **projector immediately goes into the rapid-rewind mode**. The cause of the problem—a **sticky latch for the rapid-rewind switch**. The symptom just calls for a simple cleaning of the latch.
2. The **reels won't turn to run the film through the projector**. We've already mentioned one possible cause—a **broken shutter gear**. The other possibility—the **in-and-out cam has come loose from the cam shaft**. Either of these problems can be repaired with minimum disassembly. And only one of the problems—the broken shutter gear—requires a part.

Rather than covering the Moviedeck series in detail, we'll concentrate on the three normal repairs. Your background in repairing the M-series of projectors should prepare you for the Moviedeck series.

DISASSEMBLY STEPS

1. Pull off the two side covers, Fig. MD1. **Caution:** the legs on the side covers that clip to the projector can break.
2. Remove the supply spindle, Fig. MD1. Just use your probe to move the spring, Fig. MD1, from right to left—then lift the supply spindle straight up.
3. From the bottom of the projector, remove the four top-cover screws, Fig. MD2. Use a thin-wall 1/4" nut driver. Note that the two long screws go closer to the back of the

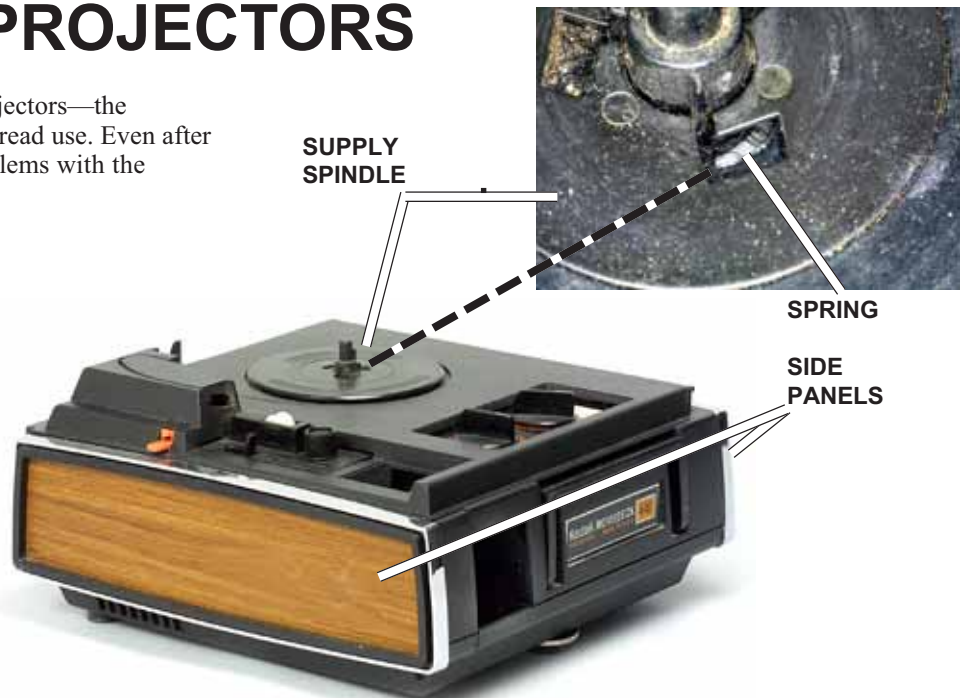

FIG. MD1 The Moviedeck 447. All the projectors in the Moviedeck series are very similar to one another.

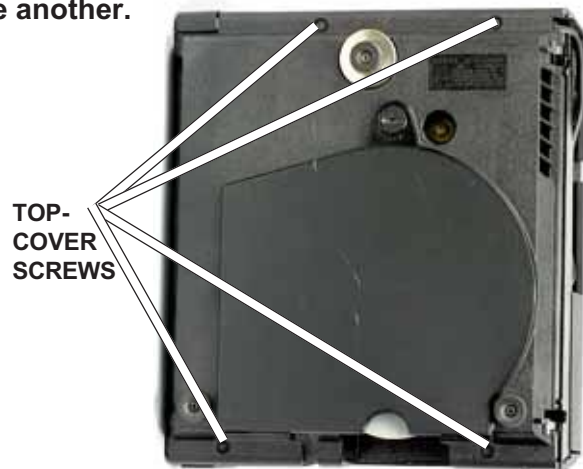

FIG. MD2 Bottom view.

projector.

4. Turn over the projector and lift off the top cover.

You can now see the shutter gear through the access cutout, Fig. MD3. Fig. MD4 shows a single-blade shutter, the type of shutter that has the plastic gear. In this example, the gear is broken—the teeth have been sheared off. Your inspection has shown that it's necessary to order a rebuilt shutter. But first remove the old shutter; you can then send in the old shutter and receive the exchange price.

Fig. MD5 shows the metal gear of the 3-blade shutter. You can't get the 3-blade shutter as a replacement part. But, as



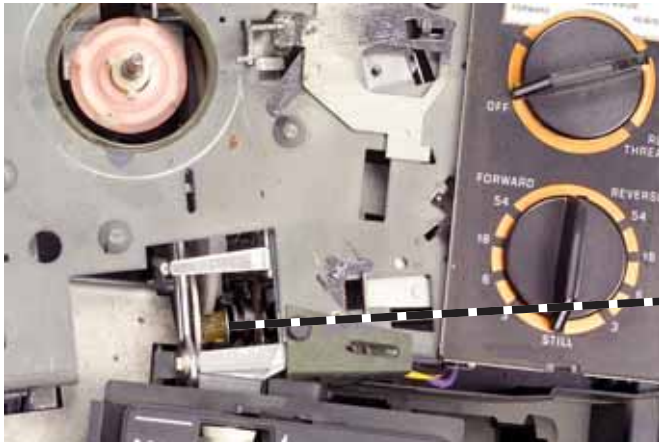

FIG. MD3 Top of projector, top cover removed.

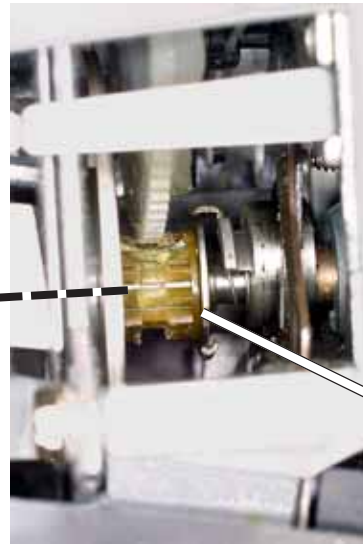

FIG. MD4 Close-up of broken shutter gear in the single-blade shutter.

SHUTTER GEAR

TAP THE CAM SHAFT WITH A HAMMER TO RESEAT IT IN THE IN-AND-OUT CAM

IN-AND-OUT CAM



FIG. MD6 Cam shaft at the back of the projector.

already mentioned, that's no problem—the teeth of the metal shutter gear never seem to break.

If the problem is that the projector goes immediately into the fast-rewind mode, you need go no further in the disassembly. Locate the latch in Fig. MD7 that controls the rapid-rewind switch. The latch probably just needs cleaning—it get sticky from dirt and old lubrications. The rapid-rewind switch then stays closed. Use your cleaner and cleaning brush to degrease and scrub the lever.

You can also take care of the other malfunction that causes the film transport to fail. Remember, the in-and-out cam may come loose from the cam shaft. At the back of the projector, Fig. MD6, you can see the in-and-out cam and the end of the cam shaft; the cam shaft passes through a gear that's held by an E-clip.

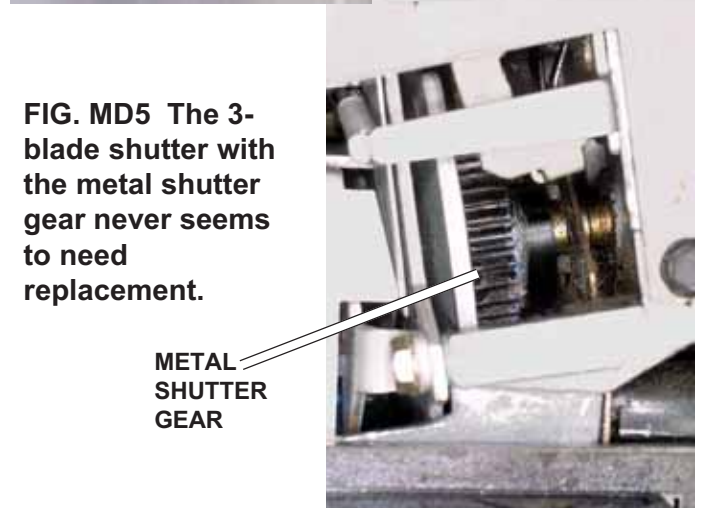
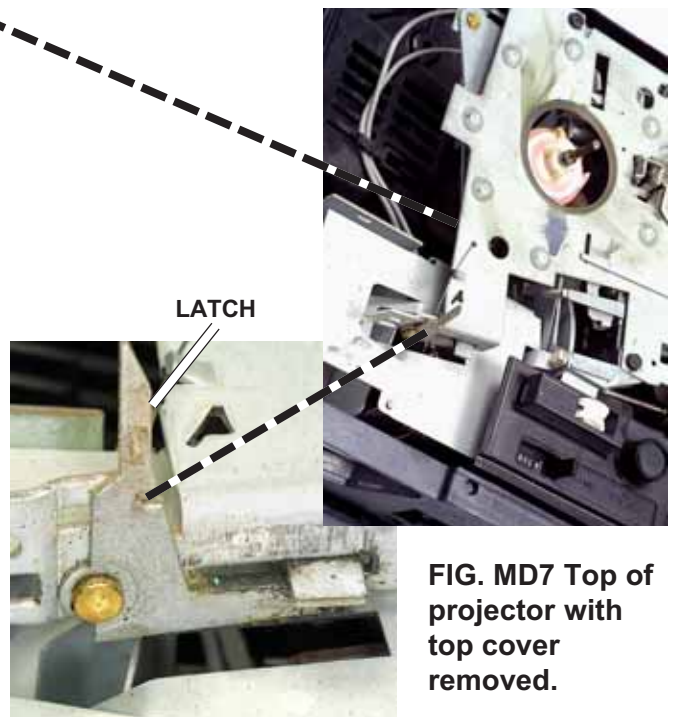

FIG. MD5 The 3-blade shutter with the metal shutter gear never seems to need replacement.

METAL SHUTTER GEAR



LATCH

FIG. MD7 Top of projector with top cover removed.



Lightly tap the end of the cam shaft, Fig. MD6, with a hammer. Tapping drives the cam shaft into the hole at the center of the in-and-out cam. Once again the in-and-out cam is mounted to—and turns with—the cam shaft.

DISASSEMBLY TO REMOVE THE SHUTTER

There's only one normal repair that requires additional disassembly—replacing the single-blade shutter. Here are the disassembly steps:

1. From the bottom of the projector, Fig. MD8, open the take-up-reel cover by turning the coin-slotted lock.
2. Remove the take-up reel by sliding over the spring shown in Fig. MD9.
3. Use your 1/4" nut driver to remove the 3 screws at the bottom of the projector, Fig. MD10. Note that the screws pass through rubber grommets; you may have to oil the rubber grommets to prevent them from turning.
4. Turn over the projector to the top. Pull the two wires (one black wire and one white wire) from under the tab, Fig. MD11.
5. At the front of the projector, remove the two screws holding the accessory outlet. You can now remove the nameplate. But, for reassembly reference, note that the nameplate goes *inside* the housing.
6. Remove the bottom section of the housing, Fig. MD12.
7. Using your 1/4" nut driver, remove the three screws pointed out in Fig. MD13.
8. Disconnect the hooked end of the spring shown in Fig. MD14.
9. Using your 1/4" nut driver, remove the screw shown in Fig. MD14.
10. Lift off the lamp housing, Fig. MD14.
11. You now have a clear view of the shutter at the front of the projector, Fig. MD15. Note the plastic cap at the front of



FIG. MD11 Top of projector.

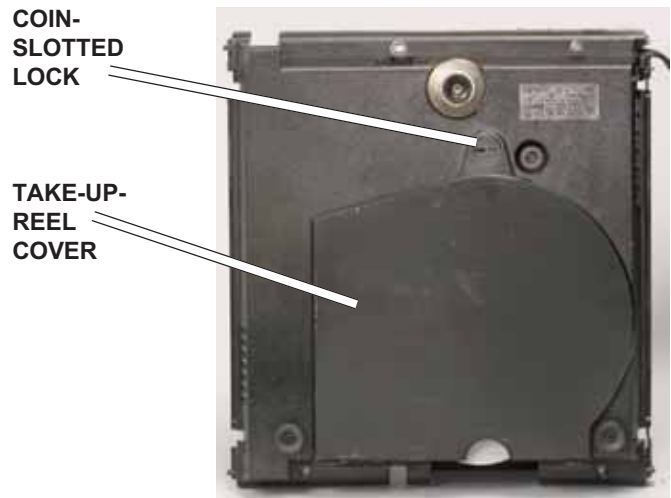

FIG. MD8 Bottom of projector.

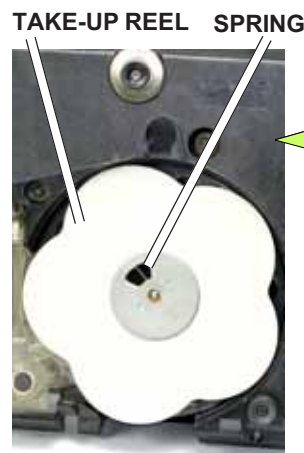

FIG. MD9 Bottom of projector, take-up-reel cover open.

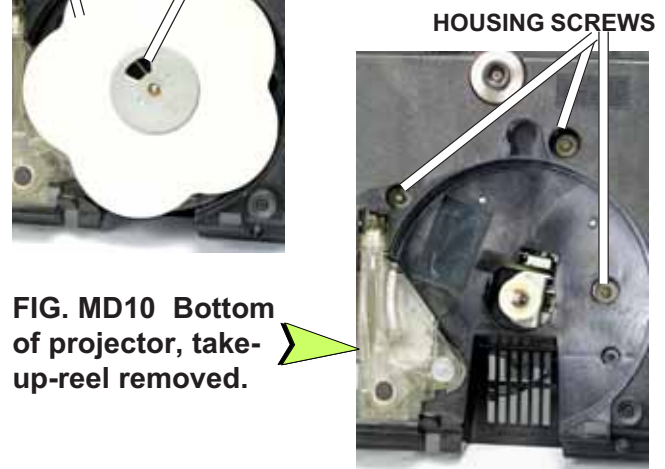

FIG. MD10 Bottom of projector, take-up-reel removed.



FIG. MD12 Front of projector.



the shutter—the tab on the cap aligns with the lamp box. Before you replace the lamp housing, make sure the extension on the cap points straight down as shown in Fig. MD15.

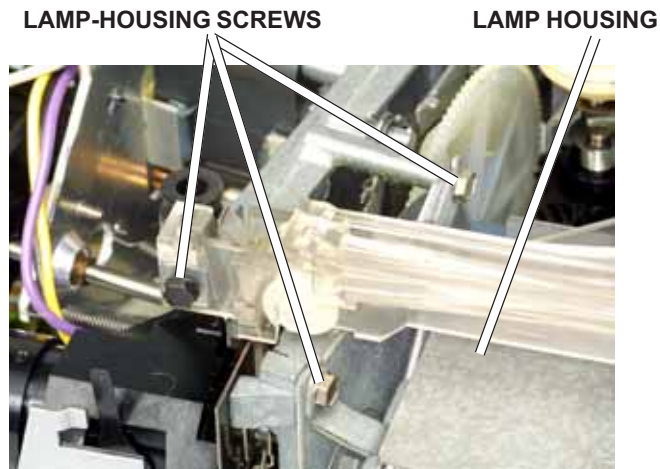

FIG. MD13 Underside of projector mechanism.

DISCONNECT HOOKED END OF SPRING



FIG. MD14 Bottom of projector mechanism from back.

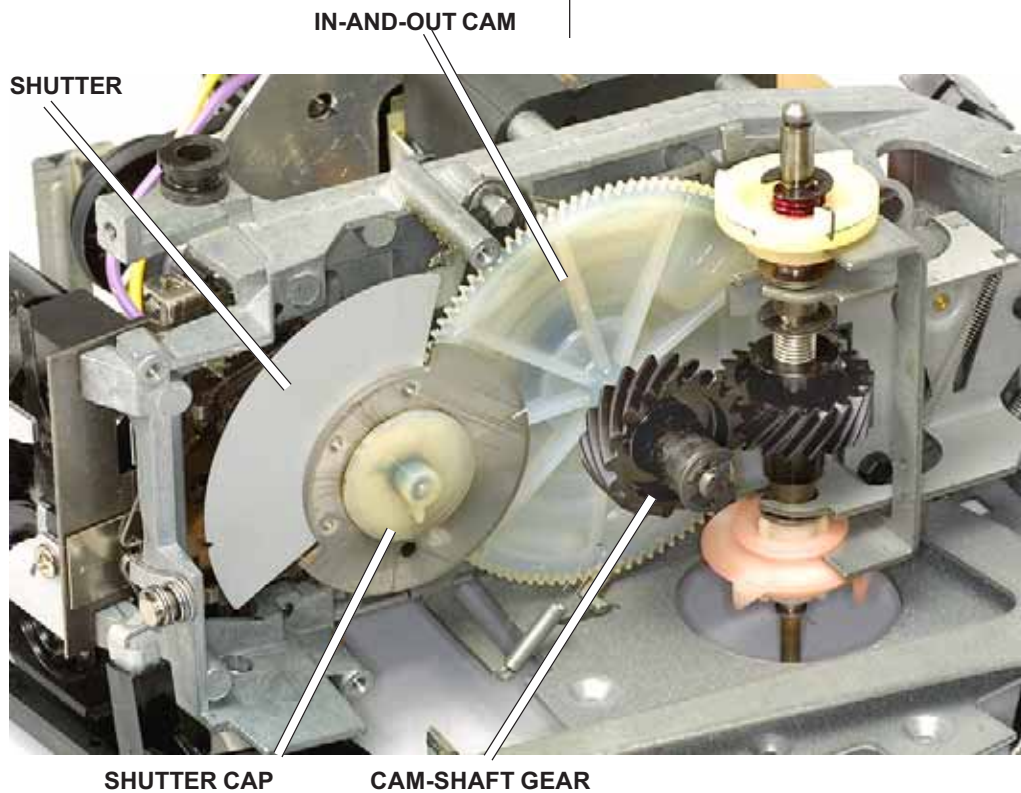

FIG. MD15 Bottom of projector, viewed from the back—lamp housing removed.



REMOVING AND REPLACING THE SHUTTER

1. Loosen the screw on the black bracket at the back of the shutter, Fig. MD16. Fig. MD17 shows how to reach the screw with a nut driver.
2. Using a screwdriver as shown in Fig. MD18, pull back the shutter-drive shaft— push over the disconnected shutter-drive shaft to your right in Fig. MD18.

NOTE: Here we're freeing the front end of the shutter-drive shaft. The brass bearing shown in Fig. MD18 stays with the shutter-drive shaft.

3. Lift out the shutter, Fig. MD19. Watch for the coil spring that fits over the front end of the shutter-drive shaft.

Lubrication is the same as in the M80 projector. Use shutter oil to lubricate the shutter-drive shaft (between the shutter-drive shaft and the brass bearing, Fig. MD18). Also oil lubricate the end of the shutter-drive shaft that passes

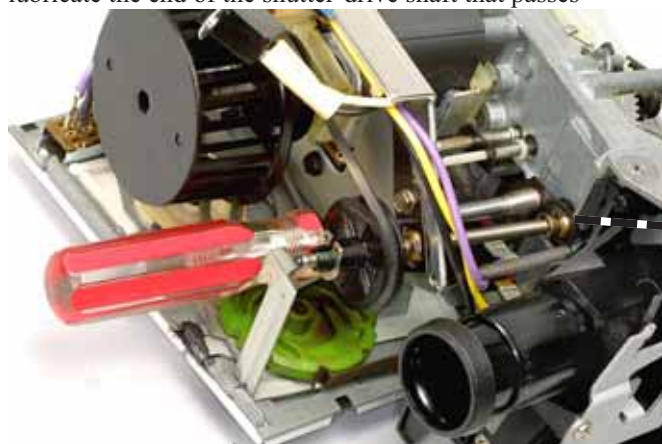

FIG. MD17 Front of projector viewed from bottom.

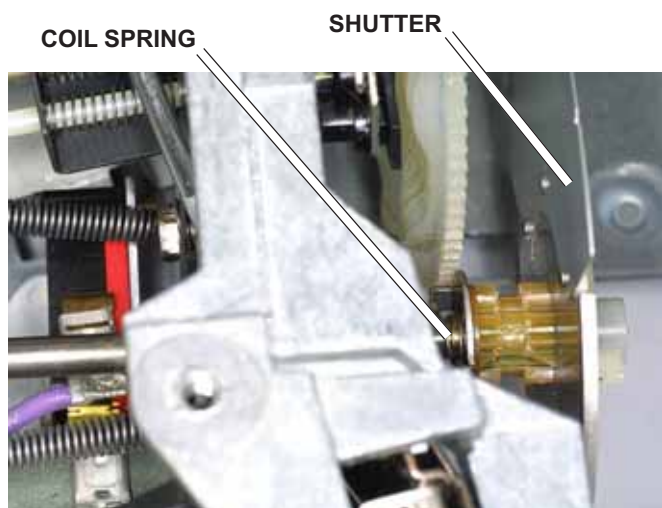

FIG. MD19 After freeing the shutter-drive shaft, lift out the old shutter. Send in the shutter for the exchange rate.

LOOSEN THIS SCREW



SHUTTER-DRIVE SHAFT

FIG. MD16 Bottom of projector viewed from front.

SCREWDRIVER

BRASS BEARING



FIG. MD18 Using a screwdriver to free the shutter-drive shaft.

HIGHLIGHTED TIMING MARK ON IN-AND-OUT CAM

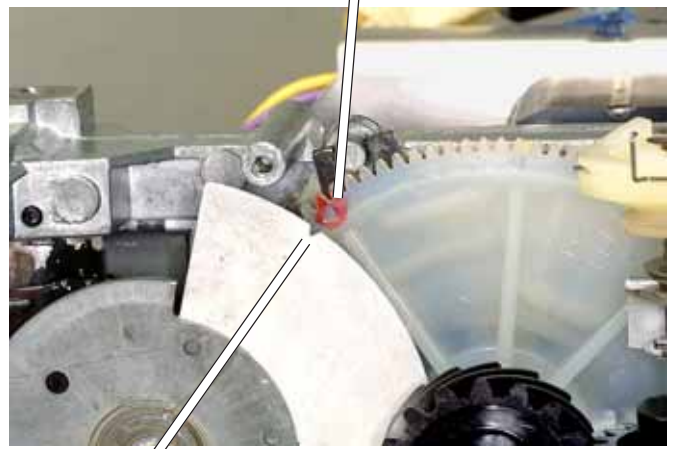

TIMING NOTCH ON SHUTTER

FIG. MD20 Timing the shutter to the in-and-out cam.



through the shutter. Lubricate the face of the in-and-out cam with grease.

On reassembly, time the shutter to the in-and-out cam just as you learned for the M-series, Fig. MD20. Notice in Fig. MD20 that there's one tooth between the highlighted timing mark on the in-and-out cam and the edge of the shutter blade. The timing mark on the in-and-out cam now points directly to the shutter blade.

Seat the shutter-drive shaft, Fig. MD16, and tighten the screw on the black bracket. As you tighten the screw, make sure the two cam-tension shafts, Fig. MD21, remain straight and free. The cam-tension shafts pass through the bracket; if the bracket shifts in position, it will bind the cam-tension shafts.

Before going further in reassembly, lubricate the cam on the shutter-drive shaft, Fig. MD22, with grease. Also grease lubricate the teeth of the shutter gear and the in-and-out cam, Fig. MD22.

CAM ON SHUTTER-DRIVE SHAFT GREASE



FIG. MD22 Grease lubrication points.

ADJUSTMENT FOR FORWARD/REVERSE CHANGEOVER



FIG. MD24



CAM-TENSION SHAFTS



SCREWDRIVER TIGHTENING BRACKET SCREW

FIG. MD21 Front of projector, viewed from bottom.

SHUTTER ARM ON STILL-MODE HEAT SHIELD



SPRING

FIG. MD23

One spring sometimes slips out of place as you're working with the shutter—the spring shown in Fig. MD23. Make sure the spring is connected to the arm of the still-mode heat shield as shown in Fig. MD23.

You can now complete the reassembly. As mentioned earlier, simply reverse the order of your disassembly. Adjustments are similar to those in the M80—even though they don't look the same and are at different positions. The adjustment shown in Fig. MD24 adjusts the forward/reverse changeover (just like using the eccentric on the forward/reverse arm in the M80). To change the depth of claw engagement, you can add or remove washers to the cam-shaft gear, Fig. MD15 (between the cam-shaft gear and the E-clip). The effect is to move the complete in-and-out cam.





KODAK INSTAMATIC M80 MOVIE PROJECTOR



REGULAR 8MM FILM

BASIC DIFFERENCES BETWEEN REGULAR 8MM AND SUPER 8

1. 50% greater picture area with super 8 film.
2. Smaller perforations and center location with super 8 film.
3. Less space between frames with super 8 film.

SUPER 8 FILM



KODAK INSTAMATIC M80 Movie Projector Features

Fully automatic threading right onto take-up reel. Reel automatically accepts both film types

Flip-top cover with powered spindles

400-foot reel capacity for approximately half-hour showings of your movies

Accepts super 8 and regular 8mm films. Combination feature controlled by two-position knob

Fast, power rewind

Modern, low-format design

KODAK Projection EKTANAR f/1.5 Lens plus new lamp design provides brilliant images. Available f/1.5 KODAK Zoom Lens lets you adjust picture size to fit your screen without moving the projector or screen

Motor-lamp switch with a choice of lamp brilliance

Single control for forward, reverse, and still projection with a choice of projection speeds—normal, slow-motion (6 fps), and rapid (54 fps)

Unique, latching film guide roller prevents spilling of film from reel while threading

Film Trimmer

Rugged, die-cast body with molded carry handle

Setting up

1. Place the projector on a table or other firm support of convenient height. The height of the table should be such that the projection lens is opposite the center of the screen. Excessive tilt of the projector produces a "keystone" effect on the screen (picture will be narrower at the bottom than at the top). Place the screen at a convenient distance from the projector, referring to the table at right.

2. Remove the TAKE-UP REEL (supplied with the projector) from the

TO FILL 40" WIDE PROJECTION SCREEN

Lens	Projector to Screen Distance	
	Super 8	Regular 8mm
22mm f1.5	14 feet	17 feet
*20-32mm f1.5 Zoom	12 to 19 feet	15 to 24.5 feet

*Lens is zoomed by sliding front portion of lens barrel forward and backward.

base of the projector by turning it clockwise until the REEL FLANGE is free of the slot in the REEL RETAINER. Then lift off the reel. The reel accepts both super 8 and regular 8mm films.

3. Unwind the POWER CORD from its

storage frame on the base of the projector. One end of the cord is permanently attached to the projector.

4. The projector operates on 110- to 125-volt, 60-cycle alternating current only. If you do not know the voltage of your electric line, ask your local electric service company.

5. Lay the projector down with the handle toward you. Push the COVER LATCH to the left as indicated by the arrow molded on the latch. The cover will spring open. Raise the cover to an upright position.

4

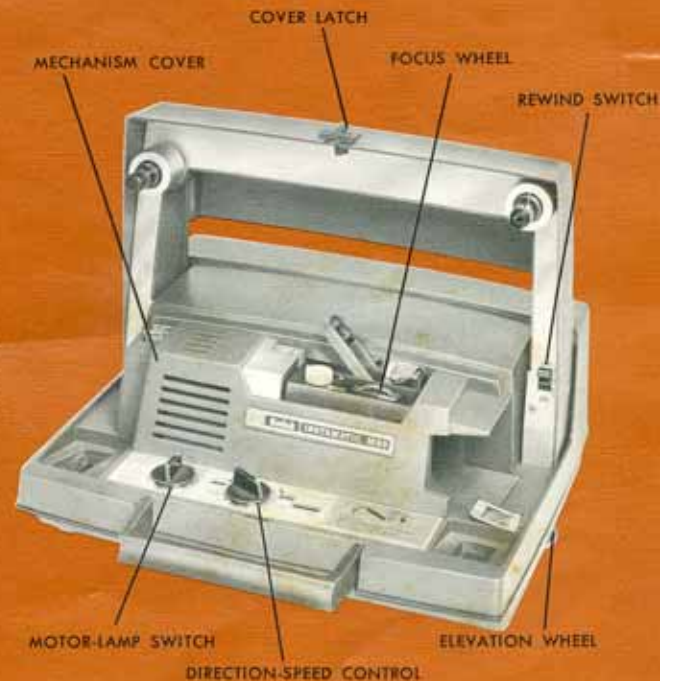

5

Adjusting for Film Type

Before threading the film it is necessary to set the projector for the type of film (super 8 or regular 8mm) you are going to project. Check the CONTROL PANEL and SUPPLY SPINDLE illustrated on page 7, to see what film type the projector is set to show.

For super 8—Control panel should show SUPER 8 and spindle adapter should be in place on supply spindle, as illustrated on page 7.

For regular 8mm—Control panel should show REG 8 and spindle adapter should be removed from supply spindle, as illustrated on page 7.

If adjustments are necessary

1. Remove the MECHANISM COVER,

illustrated on page 5, by grasping it at both ends, swinging the bottom of the cover toward the control panel and lifting it off. *To show super 8 movies*, turn the SELECTOR SWITCH clockwise as far as it will go; *to show regular 8mm movies*, turn the selector switch counterclockwise as far as it will go. Check to be sure control panel shows desired film type.

NOTE: Changing the film type on the control panel also changes the reverse (REV.) and forward (FOR.) settings of the direction-speed control.

2. *If you are going to project super 8 movies* and the supply reel SPINDLE ADAPTER is not on the supply reel spindle, remove the adapter from the

SPRING CLAMP on the inside of the mechanism cover. Line up the ARROW on the end of the adapter with the ARROW on the end of the supply reel spindle. Slide the adapter onto the spindle until the RETAINING SPRING, illustrated on page 7, on the spindle snaps into position.

3. *If you are going to project regular 8mm movies* and the supply reel spindle adapter is on the supply reel spindle, remove the adapter from the spindle by depressing the retaining spring and sliding off the adapter. Replace the adapter inside the mechanism cover. The adapter is held in place by the spring clamp.

4. Replace the mechanism cover.



CONTROL PANEL FILM TYPE SELECTOR SWITCH



CONTROL PANEL FILM TYPE SELECTOR SWITCH

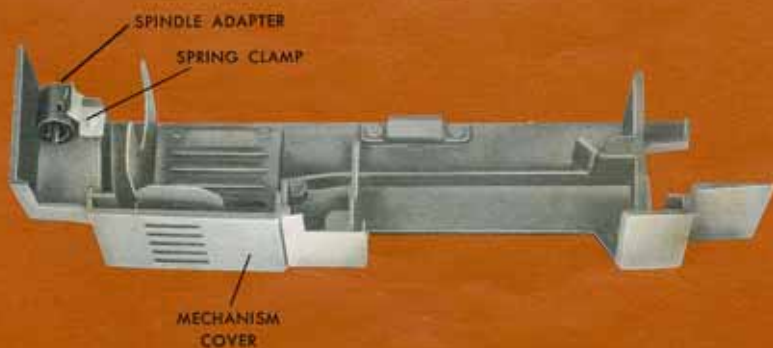

MECHANISM COVER



Threading

1. Check the control panel to see that the projector is set for the proper film type.

2. With its slotted center hole facing the projector (side marked **OTHER SIDE OUT**), place the empty **TAKE-UP REEL** on the **TAKE-UP SPINDLE**. Push the reel onto the spindle as far as it will go.

3. Place a reel of film (400 ft. maximum) on the **SUPPLY SPINDLE** so that the film comes from the bottom of the reel and the perforated edge of the film is toward you. Push the reel onto the spindle as far as it will go.

NOTE: At least one foot of white movie **LEADER** (usually supplied attached to your film by processors) should be attached to your film for threading.

4. Thread film under the **GUIDE ROL-**

LER. Press down the roller until it locks. Allow about 6" of film to extend beyond the roller to complete threading.

5. Be sure that **rewind switch** is in the **"OFF"** position.

6. Plug the power cord into a suitable electric outlet.

7. Turn the motor-lamp switch to **LO** or **HI**. If the voltage of your electric service is above 125 volts, turn the switch only to **LO**. Operating the projector with the motor-lamp switch at **LO** will greatly increase lamp life. Turn the direction-speed control to **NORM** (Normal) under **FOR** (Forward).

8. Center the lighted area on the screen vertically by turning the **ELE-**

VATION WHEEL; and horizontally, by moving the projector. Rotate the **FOCUS WHEEL** backward and forward until the margins of the lighted area are sharply defined.

9. Thread the film over the **TENSION ROLLER** and into the **FILM ENTRANCE** in short strokes until the film begins to move automatically; the guide roller will snap upward to its normal position. The film is now transported by the automatic threading mechanism through the threading path in the projector and onto the take-up reel where it attaches itself for take up.

10. Focus the picture on the screen. If a blank strip or edge of the next picture shows at the top or bottom of the picture being viewed, rotate the **FRAME KNOB** until the picture is properly centered on the screen.

8

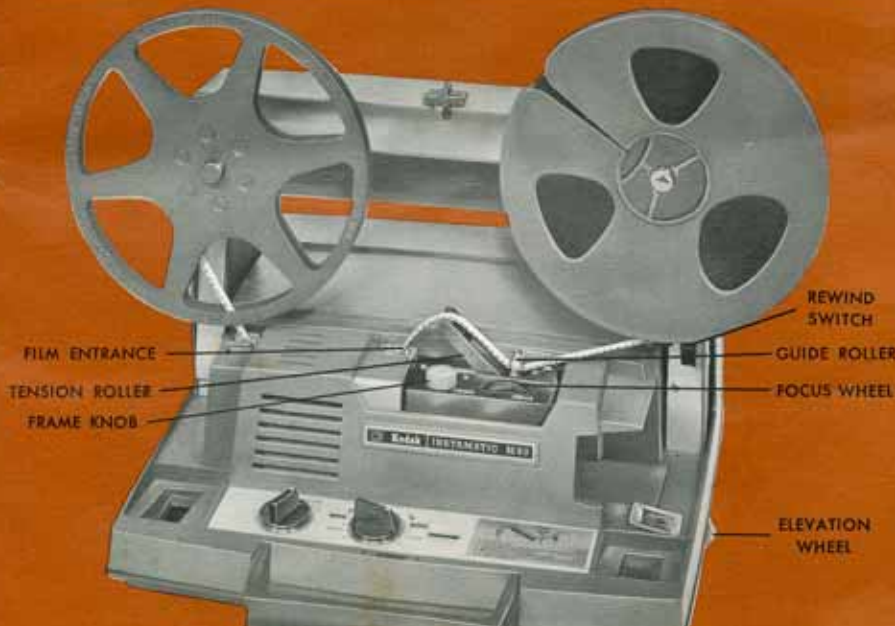

9

Projection

Darken the room sufficiently to enable a brilliant image to be projected on the screen. The room need not be totally dark. If you use a light near the projector it should not shine on the screen or into the eyes of the audience.

1. If during projection you wish to show a single frame of film, move the film direction control to **STILL**.
2. To reverse the direction of the film, move the film direction control to **REV (Reverse)**.

3. When all of the film has reached the take-up reel, move the motor-lamp switch to **OFF**.

Rewinding

Attach the film to the supply reel by sliding the film into the slot in the side of the reel and giving the reel at least one turn counterclockwise. Make sure that the first turn around the center of the reel is tight and that there is no slack between the reels.

Push the **REWIND SWITCH** downward to **ON**; then turn the motor-lamp

switch to **MOTOR**.

*After the film is completely rewound, turn the motor-lamp switch to **OFF**; then push in on the rewind switch—it will return to **OFF**.*

When the last reel has been shown and rewound, remove the reels and close the cover. Unplug the power cord and wind it behind the four corners of the storage frame, inserting the plug into its channel. Put the take-up reel over the spindle pin on the projector base, turning it counterclockwise until one of the reel flanges fits in the slot in the reel retainer.

10

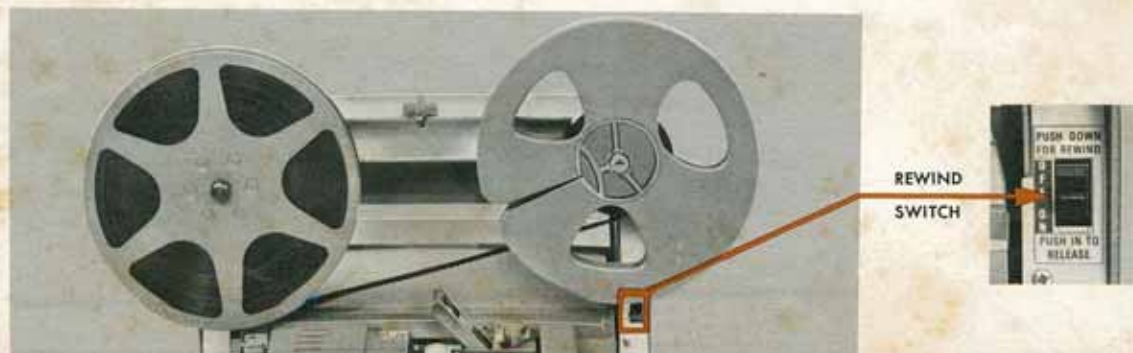

Operating Tips

1. If there are torn film perforations, the section containing them should be cut out, and the film spliced. Your Kodak dealer will be glad to recommend a splicer, such as the **KODAK PRESSTAPE Universal Splicer**, for this purpose.
2. If the picture on the screen is upside down and the action is backwards, the film has not been rewound.
3. If the film breaks, shut off the projector. Clear the broken film from the threading path by running the projector first in forward and then in reverse. Splice the film, and rewind it to the supply reel; then rethread the projector according to the instructions on page 8 and continue the show.

or

Clear the broken film from the threading path by rotating the reels by hand. This will cause one broken end to be at the supply reel, and the other end at the take-up reel. Trim the film end at the supply reel, then

rethread the projector with the film from the supply reel. When about 1½ feet of film has left the end of the threading path at the take-up reel, shut off the projector and splice this film end (from supply reel) to the end from the take-up reel. When splicing is completed, manually turn the take-up reel to wind up the slack film.

4. If the film does not thread onto the take-up reel, make sure that the end of the film is square and that there are no broken perforations near the end of the film. The film should curl in the same direction as the film is wound on the supply reel.



To square the end of the leader, place it under the **FILM TRIMMER** with one perforation over small **PIN**,

and depress the spring blade until the film is cut.

5. Processed films are generally lubricated and to prolong their life and assure smooth, quiet projection, they should be cleaned and relubricated periodically. Use **KODAK Movie Film Cleaner (with Lubricant)**. This can be purchased from your Kodak dealer.

Occasionally a film may not be lubricated by the processor. Lack of film lubrication can cause unsteady pictures. If this occurs, lubricate the film.

Projection Lamp Tips

- Rough treatment of projector, especially while lamp is lighted, may damage projection lamp.
- Make sure free passage of air is not obstructed.
- Projector operation on line voltages above range specified for lamp greatly reduces lamp life and overheats projector.
- Unplug power cord before inserting lamp in socket.
- See Projection Lamp Warranty.

Care of the Projector

The optical system of your projector must be kept clean. Dust or fingerprints will reduce picture brightness.

Lamp Replacement — Disconnect the power cord before replacing a lamp. The 150-watt, 120-volt, ASA Code DNE projection lamp can be obtained from your Kodak dealer. If a lamp should burn out during projection, accelerate cooling of the projector by running it for a few minutes with the lamp turned off. After cooling, turn off the projector. Remove the mechanism cover as described on page 6. Release the LAMP RETAINING SPRING and pull the lamp straight out from its socket.

To install a lamp, insert the lamp prongs into the socket and push the lamp in all the way. Then raise the lamp retaining spring as far as it will go. Replace the mechanism cover.

Caution: Do not turn on the lamp

with the mechanism cover removed.

Cleaning—The optical system of your projector must be kept clean. Dust or fingerprints will reduce picture brightness.

Cleaning the Projection Lens—First remove the mechanism cover. Rotate the FOCUS WHEEL until the lens is out as far as possible; then pull outward (away from the projector) on the lens retaining knob, thus releasing the spring pressure on the lens barrel, and at the same time, draw the lens straight out from its housing.

Blow any excess dust and dirt from the lens surfaces.

With KODAK Lens Cleaning Paper or a soft, lintless cloth, gently wipe the front and rear surfaces of the lens. Do not use a wet cloth; if moisture is required, breathe on the lens surface or use a drop of KODAK Lens Cleaner. Replace the lens by pulling the lens retaining knob outward; then insert the smaller end of the lens barrel in the housing, pushing it all the way back and then release the knob. Draw out

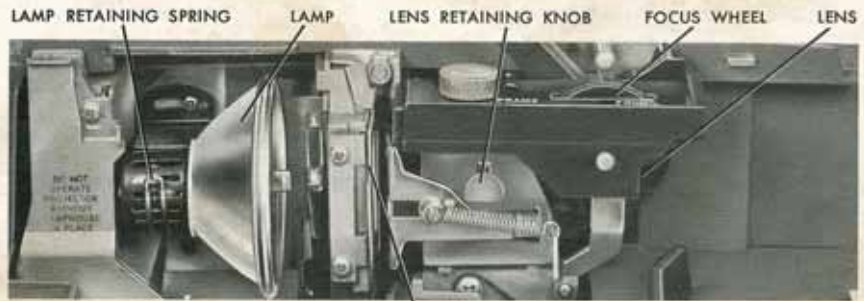

FIXED FILM GUIDE

the lens slightly until it "click-stops." Replace the mechanism cover.

Cleaning Pressure Pad and Aperture—Remove the mechanism cover and the projection lens. Draw the SPRING LATCH forward and slightly upward until it latches. Carefully remove the PRESSURE PAD by grasping the TAB and pivoting the pad forward to disengage it from the FIXED FILM GUIDE. Then gently pull it sideways and out. With a soft, damp, lintless cloth, clean the pressure pad. Remove any foreign particles from the aperture by blowing lightly on the aperture or, with the lens removed, by reaching through the lens housing and dusting with a small, soft brush. Replace the pressure pad by reversing the above removal procedure, making sure that the large, rectangular opening in the pad is located over the fixed film guide before the spring latch is released.

NOTE: Avoid rough handling of the pressure pad.

Cleaning Film Channel—Remove the mechanism cover. Push down slightly on the COVER TAB and pull outward on the FILM CHANNEL COVER. Then lift out the cover. With a small brush clean the FILM CHANNEL. With a soft, clean, lintless cloth clean the surfaces of the cover. Then replace the cover, sliding it in from the rear of the projector until the slotted end of the cover seats on the cover retaining STUD. Hold the bottom edge of the cover against the film channel. Push downward on the cover against the COVER SPRING and latch the cover. Replace the mechanism cover.

If you desire to remove the film during projection, remove the mechanism cover, the pressure pad and the film channel cover; then withdraw the film from the channel. Replace the film channel cover, the pressure pad and the mechanism cover.

Requires No Oiling—All bearings are self-lubricating.

Serial Number — The serial number of your projector is located on the plate above the film trimmer. Make a record of this number and keep it in a safe place in case your projector is lost or stolen.

