

ARCTIS

1194-7 GA



Electronic Freezer No Frost

Operating Instructions

Dear customer,

Before placing your new refrigerator/freezer into operation please read these operating instructions carefully. They contain important information for safe use, for installation and for care of the appliance. Please keep these operating instructions for future reference. Pass them on to possible new owners of the appliance.

These operating instructions are for use with several technically comparable models with varying accessories. Please observe the notes which apply to your model.



Notes which are important for your safety or for the proper functioning of the appliance are stressed with a warning triangle and/or with signal words (**Warning!**, **Caution!**, **Important!**). Please observe the following carefully.



This symbol guides you step by step in the operation of the appliance.



Supplementary information regarding operation and practical applications of the appliance appear after this symbol.



Tips and notes concerning economical and environmentally sound use of the appliance are marked with the cloverleaf.

The operating instructions contain instructions for the correction of possible malfunctions by the user in the section "What to do if ...". If these instructions should not be sufficient, contact your local Service Force Centre.

Printed on paper manufactured with environmentally sound processes
he who thinks ecologically acts accordingly...

Contents

Important Safety Instructions	4
Disposal	6
Appliance Packaging Information	6
Disposal of old Appliances	6
Remove transport packaging	6
Installation	7
Installation Location	7
Your freezer needs air	7
Reversing the door	8
Prior to Initial Start-Up	9
Electrical Connection	10
Plug socket	11
Description of the Appliance	11
View of the appliance	11
Operating and indicator panel	12
Starting up and temperature regulation	13
Ice pack	13
Freezing and storing frozen food	14
Storage Goods Symbol/Freezing Calendar	15
Preparation of Ice Cubes	16
Defrosting	16
The freezer defrosts automatically	16
Cleaning and Care	16
Magnetic door seal	17
Switching off the appliance	17
Energy Saving Tips	18
What to do if	18
Correcting Malfunctions	18
Service & Spare Parts	21
Help us to Help You	21
Customer Care	21
Guarantee Conditions	22
Noises during Operation	23
Regulations, Standards, Guidelines	24
Technical terminology	25



Important Safety Instructions

These warnings are provided in the interests of your safety. Ensure you fully understand them before installing or using the appliance. Your safety is of paramount importance. If you are unsure about the meaning of these warnings contact the Customer Care Department for assistance.

Intended use

- The freezer is intended for use in the home. It is suitable for the freezing and storing frozen food, as well as for making ice. If the appliance is used for purposes other than those intended or used incorrectly, no liability can be accepted by the manufacturer for any damage that may be caused.
- Alterations or changes to the freezer are not permitted for reasons of safety.
- If you use the freezer in a commercial application or for purposes other than the freezing or frozen storage of foods, the manufacturer accepts no liability for any damages which may occur.

Prior to initial start-up

- Ensure that the appliance does not stand on the electrical supply cable. Important: if the supply cable is damaged, it must be replaced by a cable available from the manufacturer or your local Service Force Centre.
- Check the appliance for transport damage. Under no circumstance should a damaged appliance be plugged in. In the event of damage, please contact your supplier.

Refrigerant

The refrigerant isobutane (R600a) is contained within the refrigerant circuit of the appliance, a natural gas with a high level of environmental compatibility, which is nevertheless flammable.

- During transportation and installation of the appliance, be certain that none of the components of the refrigerant circuit become damaged.
- If the refrigerant circuit should become damaged:
 - avoid open flames and sources of ignition;
 - thoroughly ventilate the room in which the appliance is situated.

Safety of children

- Packaging (e.g. wraps, polystyrene) can be dangerous for children. There is a risk of suffocation! Keep packaging material away from children!
- Please make old appliances unusable prior to disposal. Pull out the mains plug, cut off the mains cable, break or remove spring or bolt

catches, if fitted. By doing this you ensure that children cannot lock themselves in the appliance when playing (there is risk of suffocation!) or get themselves into other dangerous situations.

- Often children cannot recognise the hazards present in household appliances. It is therefore important that you ensure adequate supervision and never let children play with the appliance!

Daily Operation

- Containers with flammable gases or liquids can leak at low temperatures. There is a risk of an explosion! Do not store any containers with flammable materials such as spray cans, fire extinguisher refill cartridges etc in the appliance.
- Bottles and cans must not be placed in the freezer. They can burst when the contents freeze, high carbonate content drinks can even explode! Never store lemonade, juices, beer, wine, sparkling wine etc in the freezer. Exception: high alcohol content spirits can be stored in the freezer.
- Do not put ice creams or ice cubes in the mouth immediately after removal from the freezer. Very cold ice can freeze to the lips or tongue and cause injury.
- Do not touch frozen food with wet hands. Your hands could freeze to the food.
- Do not operate any electrical appliances in the freezer (e.g. electric ice cream makers, mixers etc.).
- Placing frozen goods on the top of the appliance can lead to the accumulation of condensation in the cavity of the storage tray through contact with the cold. Electronic components are housed within this cavity. If condensation should drip onto these components, the appliance could be damaged by a short circuit. For this reason do not place frozen goods on top of the appliance.
- Before cleaning the appliance, always switch off the appliance and unplug it, or pull the house fuse or switch off the circuit breaker.
- When unplugging always pull the plug from the mains socket, do not pull on the cable.

In case of malfunction

- If a malfunction occurs on the appliance, please look first in the "What to do if ..." section of these instructions. If the information given there does not help, please do not perform any further repairs yourself.
- Under no circumstance should you attempt to repair the appliance yourself. Repairs carried out by inexperienced persons may cause injury or serious malfunctioning. Contact your local AEG Service Force Centre.

Disposal

Appliance Packaging Information

All materials are environmentally sound! They can be disposed of or burned at an incinerating plant without danger.

About the materials: The plastics can be recycled and are identified as follows:

>PE< for polyethylene, e.g. the outer covering and the bags in the interior.

>PS< for polystyrene foam, e.g. the pads, which are all free of chloro-fluorocarbon.

The carton parts are made from recycled paper and should be disposed of at a waste-paper recycling collection location.

Disposal of old Appliances

For environmental reasons, refrigeration appliances must be disposed of properly. This applies to your old appliance, and - at the end of its service life - for your new appliance as well.



Warning! Before disposing of old appliances make them inoperable. Remove plug from mains, sever the power cable, remove or destroy any snap or latch closures. This ensures that playing children do not lock themselves inside the appliance (danger of suffocation!) or place themselves into other life-endangering situations.

Disposal:

- The appliance may not be disposed of with domestic waste or bulky refuse.
- The refrigerant circuit, especially the heat exchanger at the back of the appliance, must not be damaged.
- Information concerning collection schedules or locations can be obtained from your local Council or Environmental Health Office.

Remove transport packaging

The appliance and the interior fittings are protected for transport.



Pull off the adhesive tape on the left and right side of the door.



You can remove any remnants of adhesive using white spirit.



Remove all adhesive tape and packing pieces from the interior of the appliance.

Installation

Installation Location

The appliance should be set up in a well ventilated, dry room.

Energy use and efficient performance of the appliance is affected by the ambient temperature.

The appliance should therefore

- not be exposed to direct sunlight;
- not be installed next to radiators, cookers or other sources of heat;
- only be installed at a location whose ambient temperature corresponds to the climate classification, for which the appliance is designed.

The climate classification can be found on the serial plate, which is located at the left on the inside of the appliance.

The following table shows which ambient temperature is correct for each climate classification:

Climate classification	for an ambient temperature of
SN	+10 to +32 °C
N	+16 to +32 °C
ST	+18 to +38 °C
T	+18 to +43 °C

If the refrigeration appliance is installed next to another refrigerator or freezer a clearance of 5 cm at the sides is required, in order to prevent the formation of condensation on the outside of the appliance.

Your freezer needs air

For correct operation this appliance must be located in a dry atmosphere, away from heat sources, e.g. cookers, radiators, boilers and direct sunlight.

You should also ensure that air can circulate freely around the back and the top of the cabinet. There should be 100mm (4") between the top of the cabinet and any overhanging kitchen furniture.

Alternatively allow 50mm (2") between the top of the cabinet and any overhanging kitchen furniture and a gap of 25mm (1") on either side of the appliance.

Do not obstruct the space underneath. The back of the cabinet may be placed close to the wall but must not touch it. DO NOT install in places with restricted ventilation.

Adjust the level of the appliance by screwing out the adjustable foot, or feet, at the bottom of the cabinet using your fingers.

If your refrigerator is installed under a continuous worktop, an air outlet opening of at least 200 cm² and a ventilation grille matching the worktop design should be installed at the rear of the worktop.

The cut surfaces of the worktop should be varnished to avoid swelling due to penetration of moisture.

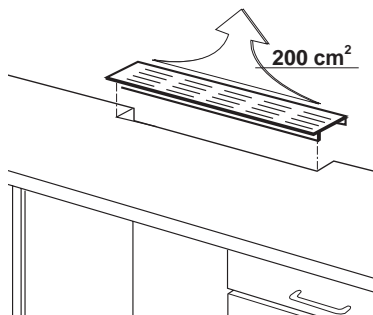

Reversing the door

The side at which the door opens can be changed from the right side (as supplied) to the left side, if the installation site requires.



Warning! When changing the side at which the door opens, the appliance must not be connected to the mains. Remove plug from the mains beforehand.



Tilt the appliance slightly towards the rear and prop it securely.



Unscrew the door hinge screws (K) and remove the hinge pin bracket (1).



Open the door a little way and take it out downwards.

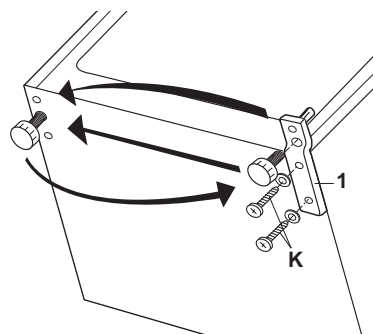

- ☞ Unscrew the upper pin (A) and screw it into place on the opposite side.
- ☞ Fit the door into the upper pin (A) and close it.
- ☞ Screw the hinge pin bracket (1) securely into place on the opposite side using the screws (K).

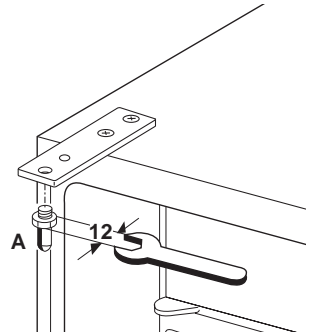

- ☞ Unscrew the handle. Refit it on the opposite side after having pushed in the plugs with a punch. Cover the holes left open with the plugs contained in the documentation pack.

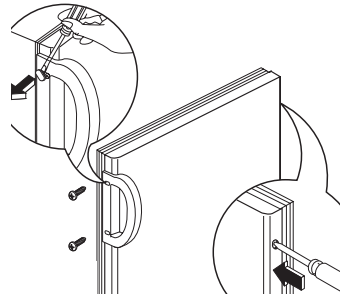

Prior to Initial Start-Up

- ☞ Please clean the appliance interior and all accessories prior to initial start-up (see section: "Cleaning and Care").
- ☞ Remove the ice pack from the appliance.
- ☞ Only put the ice pack to freeze in the top drawer after the optimal storage temperature of $-18\text{ }^{\circ}\text{C}$ has been reached.
- ☞ Re-freeze thawed ice packs in the same way, e. g. after cleaning the appliance.

Electrical Connection

Any electrical work required to install this appliance should be carried out by a qualified electrician or competent person.



WARNING – THIS APPLIANCE MUST BE EARTHED

The manufacturer declines any liability should these safety measures not be observed.

Before switching on, make sure the electricity supply voltage is the same as that indicated on the appliance rating plate. The rating plate is inside, on the left.

The appliance is supplied with a 13 amp plug fitted. In the event of having to change the fuse in the plug supplied, a 13 amp ASTA approved (BS 1362) fuse must be used.

Important

The wires in the mains lead are coloured in accordance with the following code:

Green and Yellow:	Earth
Blue:	Neutral
Brown:	Live

As the colours of the wires in the mains lead of this appliance may not correspond with the coloured markings identifying the terminals in your plug, proceed as follows:

- 1.The wire coloured green and yellow must be connected to the terminal marked with the letter "E" or by the earth symbol or coloured green and yellow.
- 2.The wire coloured blue must be connected to the terminal "N" or coloured black.
- 3.The wire coloured brown must be connected to the terminal marked "L" or coloured red.
- 4.Upon completion there must be no cut, or stray strands of wire present and the cord clamp must be secure over the outer sheath.



Warning! A cut-off plug inserted into a 13 amp socket is a serious safety (shock) hazard. Ensure that the cut-off plug is disposed of safely.

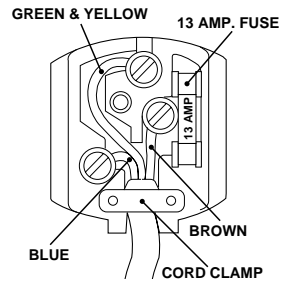

Plug socket

The plug socket necessary for connection of your appliance to the electricity supply should be positioned so that it is possible to pull out the appliance plug.

If your appliance is installed under a continuous worktop, the plug socket should be provided as shown.

Alternatively a concealed spur socket fitted with a 13 A fuse may be fitted.

If the socket is not accessible once the appliance is built in, the electrical installation must include suitable means of isolating the appliance from the mains (e.g. fuse, cut-out, current trip or similar with a minimum contact separation of 3 mm).

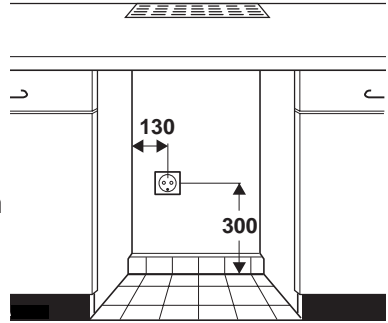

Description of the Appliance

View of the appliance

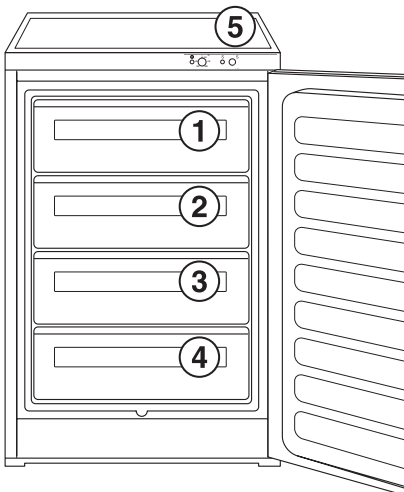

- 1 Drawer for storage
- 2 Drawer for storage
- 3 Drawer for storage
- 4 Drawer for storage and freezing fresh food
- 5 Control panel

Your appliance is frost free, which means there is no need to manually defrost your appliance as this will be carried out automatically.

The freezer has stops to prevent the drawers from falling out when fully extended.

To remove the drawers (e.g. for cleaning purposes), pull them out as far as the stops, lift and extract.

Operating and indicator panel

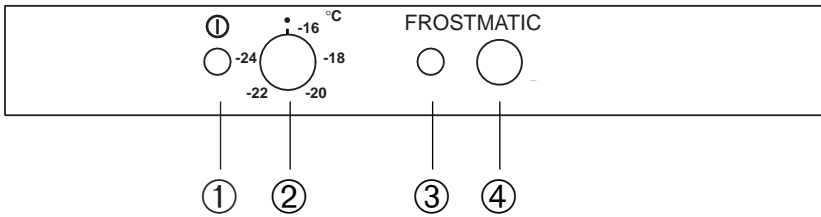

- 1 Pilot light (green)
- 2 Temperature control knob and ON/OFF switch
- 3 Fast freeze (FROSTMATIC) light (amber)
- 4 Fast freeze (FROSTMATIC) button

The **temperature control knob (2)**, which incorporates the appliance's ON/OFF switch.

The **green pilot light (1)**, which comes on when the appliance is activated by turning the thermostat knob (2) beyond the "-16°C" position. In this switch position, the refrigerating unit automatically operates by system control.

The **temperature control knob (2)**, is used for continuously variable setting of the most energy saving storage temperature for your frozen food.

The optimum storage conditions occur at -18°C.

The **FROSTMATIC button (4)** with its **amber pilot light (3)**. The amber pilot light comes on when the switch (4) has been operated. The refrigerating unit then operates continuously.

Important note: if you operate the FROSTMATIC button or adjust the temperature control knob, your appliance's refrigeration motor may not start immediately, but does after some time. This does not mean that your appliance has a fault.

After adjusting the temperature, leave the appliance to set the temperature and allow 24 hours for the temperature to stabilise before making further changes.

Starting up and temperature regulation

- ☞ Turn the temperature control knob (2) in the direction of "-16°C". The green light (1) and the amber light (3) come on and the refrigeration motor starts up and runs continuously. The appliance electronics switch off the FROSTMATIC function after 5 hours. The amber light (3) goes out.

During normal operation:

- ☞ Operate FROSTMATIC by depressing the FROSTMATIC button (4) for more than one second.

The amber pilot light (3) comes on and the refrigerator motor runs continuously.

- ☞ After 3-4 hours you should reset the FROSTMATIC button (4); the amber light (3) goes out.

If the FROSTMATIC function is not ended manually, the appliance electronics switch off the FROSTMATIC function after 48 hours. The amber light (3) goes out.

The temperature control knob (2) can be used to set the required storage temperature, -18°C or colder.

Setting „●“ means:
Off.

Setting "-16°C" means:
highest, warmest internal temperature

Setting "-24°C" means:
lowest, coldest internal temperature

Recommended control knob setting:
"-18°C".

Ice pack

There is an ice pack in one drawer of the freezer.

Refer to the section "Prior to Initial Start-Up" concerning freezing of the ice pack.

- i** In the event of a power failure or malfunction, the ice pack will lengthen the amount of time it takes for the frozen food to defrost by several hours.

The ice pack can only fulfil this task optimally if it is placed in the uppermost drawer, at the front, above the frozen food.

You can use the ice pack for cooling cold bags.

Freezing and storing frozen food

You can use your freezer for freezing fresh food yourself.

Important!

- The temperature in the freezer compartment must be -18°C or colder before freezing food.
- Please observe the freezing capacity given on the rating plate. The freezing capacity is the maximum quantity of fresh food that can be frozen within a period of 24 hours. If you wish to freeze food several days in a row, please observe a maximum capacity of only 2/3 to 3/4 of that on the rating plate. The quality of the food is best preserved when it is frozen right through to the core as quickly as possible.
- To obtain the best performance from this appliance, we suggest that all of the internal baskets are used.
- Allow warm food to cool down before freezing. The warmth will cause increased ice formation and increase the power consumption.
- Please note the maximum storage times specified by the manufacturer.
- Thawed foods which have not been processed further (cooked into meals) may not under any circumstances be frozen a second time.
- Containers with flammable gases or liquids can leak at low temperatures. There is a risk of an explosion! Do not store any containers with flammable materials such as spray cans, fire extinguisher refill cartridges etc in the freezer.
- Bottles and cans must not be placed in the freezer. They can burst when the contents freeze, high carbonate content drinks can even explode! Never store lemonade, juices, beer, wine, sparkling wine etc. in the freezer.
- To ensure the correct functioning of the appliance, no foodstuffs should be stored directly against the cold air outlet.



Press the FROSTMATIC button for freezing of fresh food. The amber light illuminates.

To utilise the maximum rated freezing capacity, switch on the fast freeze switch 24 hours before freezing is due to start (the amber light illuminates). For smaller amounts the fast freeze switch should be switched on 4 - 6 hours in advance.



All foods must be packed air tight prior to freezing, so that they do not dry out or lose their flavour, and so that no flavour contamination of other frozen goods occurs.

Because freezing is faster with frost free technology, once food is defrosted, it retains all of its original texture, vitamins and taste.

Caution! Do not touch frozen food with wet hands. Your hands could stick to the food and cause skin abrasions.

 Place the packed food in the drawers. Place food to be frozen in the bottom drawer (4) of the freezer as this is the coldest part. Unfrozen food must not touch items already frozen, otherwise the frozen food could begin to defrost. Freezer drawers (1), (2) and (3) should only be used for storage of frozen food so that the bottom drawer can be used for a further freezing operation.



Place frozen foods in the drawers sorted by type, as far as possible.



Once the required storage temperate has been reached, press the FROSTMATIC button again. The yellow light goes out.

Tips:

- The following are suited for the packaging of frozen goods:
 - freezer bags and polyethylene wraps;
 - special cans for frozen goods;
 - extra-thick aluminium foil.
- The following are suitable for sealing bags and wrap: plastic clips, rubber bands or tape.
- Smooth the air out of the bag before sealing; air makes it easier for the frozen food to dry out.
- Make flat packages, because these freeze more quickly.
- Do not fill cans for frozen goods to the brim with liquid or paste-like goods, because liquids expand during freezing.

Storage Goods Symbols/Freezing Calendar

• The symbols on the drawers show different types of frozen goods.

• The numbers indicate storage times in months for the appropriate types

of frozen goods. Whether the upper or lower value of the indicated storage time is valid depends on the quality of the foods and pre-treating before freezing. The lower value applies to foods with high fat content.



Preparation of Ice Cubes

 Fill the ice cube tray 3/4 full with cold water, place it in the freezer compartment and leave to freeze.

 To loosen the frozen cubes, either bend the ice cube tray or hold it under running water for a few seconds.

Important! Never try to free an ice tray that is frozen to the freezer compartment using pointed or sharp edged objects. Use the ice scraper supplied.

Defrosting

The freezer defrosts automatically

Your appliance has been designed to be frost free. This means there is no need to manually defrost your appliance as this will be carried out automatically.

The water from the thawing frost evaporates by itself.

Cleaning and Care

For hygienic reasons the appliance interior, including interior accessories, should be cleaned regularly.



Warning!







- The appliance may not be connected to the mains during cleaning. Danger of electrical shock! Before cleaning switch the appliance off and remove the plug from the mains, or disconnect from the power supply.
- Never clean the appliance with a steam cleaner. Moisture could accumulate in electrical components, danger of electrical shock! Hot vapours can lead to the damage of plastic parts.
- The appliance must be dry before it is placed back into service.

Important!

- Ethereal oils and organic solvents can attack plastic parts, e.g.
 - lemon juice or the juice from orange peel;
 - butyric acid;
 - cleansers which contain acetic acid.

Do not allow such substances to come into contact with appliance parts.







- Do not use any abrasive cleansers.

-  Remove frozen food from the freezer. Wrap frozen food in several layers of newspaper. Store it in a cool place, well covered.
-  Switch the appliance off and remove the plug from the mains, or switch off or turn out the circuit breaker or fuse.
-  Clean the appliance and the interior accessories with a cloth and lukewarm water.
-  After cleaning wipe with fresh water and rub dry.
-  Accumulation of dust at the condenser increases energy consumption. For this reason carefully clean the condenser at the back of the appliance once a year with a soft brush or a vacuum cleaner.
-  After everything is dry, switch to fast freeze. After running the appliance for two or three hours, it is ready again for storing frozen food. Once the frozen food has been placed in the freezer, return the fast freeze button to the off position.

Magnetic door seal

After opening and closing the door of your freezer whilst it is in operation, you will not immediately be able to open the door again because a vacuum will have developed inside, keeping the door closed until the pressures inside and outside the door have equalised. After a few minutes you can easily reopen the door.

Switching off the appliance

-  To switch off the appliance, turn the temperature regulator to position "0".
- If the appliance is not going to be used for an extended period:**
-  Remove all deep-frozen packages as well as ice-trays.
-  Switch off the appliance by turning the temperature regulator to position "0".
-  Remove the mains plug or switch off or disconnect the electricity supply.
-  Clean thoroughly (see section: "Cleaning and Care").
-  Leave the door open to avoid the build up of odours.



Energy Saving Tips

- Do not install the appliance near cookers, radiators or other sources of warmth. High ambient temperatures cause longer, more frequent operation of the compressor.
- Ensure sufficient air circulation and exhaust at the appliance base and at the back wall of the appliance. Never cover air vent openings.
- Do not place warm foods into the appliance. Allow warm foods to cool first.
- Only leave door open as long as necessary.
- Do not set temperature any colder than necessary.
- Put frozen food in the fridge to defrost. The cold in the frozen food will then be used to cool the fridge.
- Always keep the heat emitting condenser, the metal grille on the rear wall of your appliance clean.

What to do if ...

Correcting Malfunctions

Spare parts:

The following spare parts can be ordered from your local AEG Service Force Centre. You can fit these yourself without any special skill or training, e.g.:

- freezer drawers,
- door handle

A malfunction may be caused by only a minor fault that you can rectify yourself using the following instructions. Do not perform any other work on the appliance if the following information does not provide assistance in your specific case.

Please check whether the pilot lights come on, the refrigerating unit operates, and the internal temperature is being maintained. Do not perform any other work on the appliance if the following information does not provide assistance in your specific case.



Warning! Repairs to refrigerators/freezers may only be performed by competent service engineers. Improper repairs can give rise to significant hazards for the user. If your appliance needs repairing, please contact your specialist dealer or your local Service Force Centre.



If the freezer system has stopped working and the freezer is full, the reserve in the cold accumulator and in the deep frozen food itself will give the food a hold over time of about 14 hours.

Symptom	Possible Cause	Remedy
Appliance does not work, no pilot light is illuminated.	Appliance is not switched on.	Switch on the appliance.
	Mains plug is not plugged in or is loose.	Insert mains plug.
	Fuse has blown or is defective	Check fuse, replace if necessary.
	Socket is defective.	Electrical malfunctions are to be corrected by an electrician.
Green light does not light up, yellow light lights up when the FROSTMATIC function is activated.	Green light faulty.	Please inform your local Service Force Centre.
Yellow light does not light up, when the FROSTMATIC function is activated, appliance is on.	Yellow light faulty.	Please inform your local Service Force Centre.
Appliance cools too much.	Temperature is set too cold.	Turn the temperature regulator to a warmer setting temporarily.
The freezer temperature is not sufficient.	Temperature is not properly adjusted.	Please look in the "Initial Start Up" section.
	Door was open for an extended period.	Only open the door as long as necessary. Press the FROSTMATIC button.
	A large quantity of warm food placed in the appliance within the last 24 hours.	Press the FROSTMATIC button.
	The appliance is near a heat source.	Please look in the "Installation Location" section.

Symptom	Possible Cause	Remedy
Heavy build up of frost, possibly also on the door seal.	Door seal is not air tight (possibly after reversing the door).	Carefully warm the leaking sections of the door seal with a hair dryer (on a cool setting). At the same time shape the warmed door seal by hand so that it sits correctly.
Unusual noises.	Appliance is not level.	Readjust the feet.
	The appliance is touching the wall or other objects.	Move the appliance slightly.
The compressor does not start immediately after changing the temperature setting.	This is normal, no error has occurred.	The compressor starts after a period of time.

Important: regularly check on an inner thermometer to ensure that the storage temperature is being maintained.

Service & Spare Parts

In the event of your appliance requiring service, or if you wish to purchase spare parts, contact your local AEG Service Force Centre by telephoning:

08705 929 929

Your call will be automatically routed to the Service Centre covering your post code area.

For the address of your local Service Force Centre and further information about Service Force, please visit the website at www.serviceforce.co.uk

In guarantee customers should ensure that the above checks have been made as the engineer will make a charge if the fault is not a mechanical or electrical breakdown.

Please note that proof of purchase is required for in-guarantee service calls.

Help us to Help You

Please determine your type of enquiry before writing or telephoning. When you contact us we need to know:

1. Your name, address and post code.
2. Your telephone number.
3. Clear and concise details of the fault.
4. The model number and serial number (see rating plate).
5. Date of purchase.

Customer Care

For general enquiries concerning your AEG appliance and for further information on AEG products, please contact our Customer Care Department at the address below or visit our website at www.aeg.co.uk

Customer Care Department
AEG Domestic Appliances
55-77 High Street
Slough
Berkshire
SL1 1DZ
Tel: 08705 350350 (*)

(*) calls to this number may be recorded for training purposes.

Guarantee Conditions

Standard guarantee conditions

We, AEG, undertake that if within 12 months of the date of purchase this AEG appliance or any part thereof is proved to be defective by reason only of faulty workmanship or materials, we will, at our option repair or replace the same FREE OF CHARGE for labour, materials or carriage on condition that:

- The appliance has been correctly installed and used only on the electricity supply stated on the rating plate.
- The appliance has been used for normal domestic purposes only, and in accordance with the manufacturer's instructions.
- The appliance has not been serviced, maintained repaired, taken apart or tampered with by any person not authorised by us.
- All service work under this guarantee must be undertaken by an AEG Service Force Centre.
- Any appliance or defective part replaced shall become the Company's property.
- This guarantee is in addition to your statutory and other legal rights.

Home visits are made between **8.30am** and **5.30pm** Monday to Friday. Visits may be available outside these hours in which case a premium will be charged.

Exclusions

This guarantee does not cover:

- Damage or calls resulting from transportation, improper use or neglect, the replacement of any light bulbs or removable parts of glass or plastic.
- Costs incurred for calls to put right an appliance which is improperly installed or calls to appliances outside the United Kingdom.
- Appliances found to be in use within a commercial environment, plus those which are subject to rental agreements.
- Products of AEG manufacture which are not marketed by AEG.

European Guarantee

If you should move to another country within Europe then your guarantee moves with you to your new home subject to the following qualifications:

- The guarantee starts from the date you first purchased your product.
- The guarantee is for the same period and to the same extent for labour and parts as exists in the new country of use for this brand or range of products.

- This guarantee relates to you and cannot be transferred to another user.
- Your new home is within European Community (EC) or European Free Trade Area.
- The product is installed and used in accordance with our instructions and is only used domestically, i.e. a normal household.
- The product is installed taking in account regulations in your new country.

Before you move please contact your nearest Customer Care centre, listed below, to give them details of your new home. They will then ensure that the local Service Organisation is aware of your move and able to look after you and your appliance.

France	Senlis	+33 (0) 3 44 62 29 29
Germany	Nürnberg	+49 (0) 800 234 7378
Italy	Pordenone	+39 (0) 0434 39 4700
Sweden	Stockholm	+46 (0) 8 672 53 60
UK	Slough	+44 (0) 1753 219899

Noises during Operation

The following noises are characteristic of refrigeration appliances:

- **Clicks** Whenever the compressor switches on or off, a click can be heard.
- **Humming** As soon as the compressor is in operation, you can hear it humming.
- **Bubbling/ Splashing** When refrigerant flows into thin tubes, you can hear bubbling or splashing noises. Even after the compressor has been switched off, this noise can be heard for a short time.

Regulations, Standards, Guidelines

This appliance was designed for household use and was manufactured in accordance with the appropriate standards. The necessary measures in accordance with appliance safety legislation regulations (GSG), accident prevention regulations for refrigeration appliances (VBG 20) and the regulations of the German Society of Electrical Engineers (VDE) were observed in the manufacture of this appliance. The refrigerant circuit has been checked for leaks.

- CE** This appliance is in accordance with the following EU guidelines:
- 73/23/EEG dated 19 February 1973 - low voltage guidelines.
 - 89/336/EEG dated 3 May 1989 (including guideline change notice 92/31/EEG) - EMV guideline

Technical terminology

- **Refrigerant** Liquids that can be used to generate a cooling effect are known as refrigerants. They have a relatively low boiling-point, indeed so low, that the warmth from the food stored in the fridge or freezer can cause the refrigerant to boil and vaporise.
- **Refrigerant Circuit** Closed circulation system that contains the refrigerant. The refrigerant circuit comprises primarily of an evaporator, a compressor, a condenser and pipe work.
- **Evaporator** The refrigerant is evaporated in the evaporator. Similar to all other liquids, refrigerant requires heat to evaporate. This heat is removed from the interior of the appliance, as a result the interior is cooled. The evaporator is therefore located inside the appliance or placed in foam immediately behind the inner wall and thus not visible.
- **Compressor** The compressor looks like a small drum. It is driven by a built-in electric motor and is mounted on the base of the appliance at the rear. The task of the compressor is to draw in vaporised refrigerant from the evaporator, to compress it, and to pass it on to the condenser.
- **Condenser** The condenser normally has the form of a grid. The refrigerant compressed in the compressor is liquefied in the condenser. During this process, heat is released to the surrounding air at the surface of the condenser. The condenser is mounted on the base of the appliance.

AEG Hausgeräte GmbH
Postfach 1036
D-90327 Nürnberg

<http://www.aeg.hausgeraete.de>

© Copyright by AEG

02-0402

2222 696-81

Subject to change without notice

 **From the Electrolux Group. The world's No.1 choice.**

The Electrolux Group is the world's largest producer of powered appliances for kitchen, cleaning and outdoor use. More than 55 million Electrolux Group products (such as refrigerators, cookers, washing machines, vacuum cleaners, chain saws and lawn mowers) are sold each year to a value of approx. USD 14 billion in more than 150 countries around the world.