

## Series MPCJR Pump Controller Installation and Operating Manual



**MERCROID**  
**A Division of Dwyer Instruments, Inc.**  
P.O. BOX 258 • MICHIGAN CITY, INDIANA 46361, U.S.A.  
Phone: 219/879-8000 • Fax: 219/872-9057  
www.dwyer-inst.com • e-mail: lit@dwyer-inst.com

# CONTENTS

Dimensions . . . . .	1
Specifications . . . . .	2
Getting Started . . . . .	3
Model Identification . . . . .	3
Installation . . . . .	4
Wiring . . . . .	5-7
Front Panel Functions . . . . .	8-9
Home Display . . . . .	9
Security Level Selection . . . . .	10
Lead/Lag Operation . . . . .	11
Analog Retransmission Operation . . . . .	12
Serial Communication Operation . . . . .	13
Menu Selections . . . . .	14
Secondary Menu . . . . .	14
Secure Menu . . . . .	15-20
Alarm Type and Action . . . . .	17-19
Diagnostic Error Messages . . . . .	21-22
Programming Chart . . . . .	23-24
Programming Example . . . . .	25-27

# DIMENSIONS

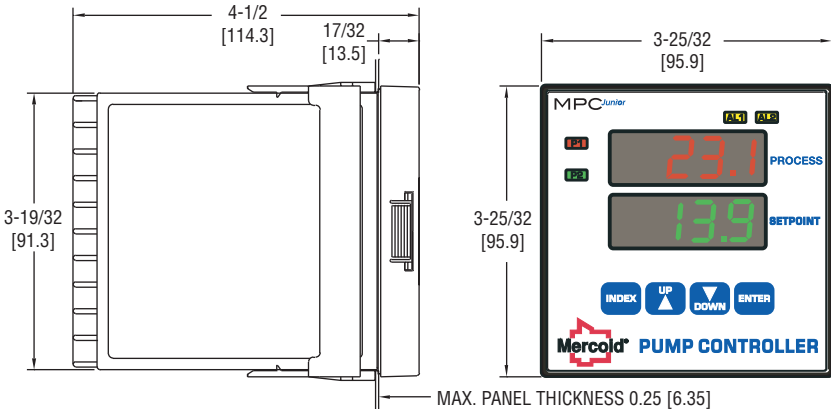

## SPECIFICATIONS

**Inputs:** 0 (or 4) to 20 mA DC or 0 (or 2.0) to 10.0 VDC selectable.

**Input Impedance:** Current input: 10 ohms, Voltage input: 5K ohms.

**Output Ratings:**

Control Relays: SPDT, rated 10A @ 240 VAC res., 1/4 hp @120 VAC, 1/3 hp @ 240 VAC;

Alarm Relays: SPST, 3A @ 240 VAC res., 1/10 hp @ 120 VAC;

Other: 15 VDC @ 20 mA for output one and output two.

**Control Type:** On/off, reverse or direct acting.

**Power Requirements:** 100 to 240 VAC nominal, +10%-15%, 50 to 400 Hz, single phase; 132 to 240 VDC nominal, +10%-15%.

**Power Consumption:** 7.5 VA maximum.

**Accuracy:**  $\pm 0.25\%$  of span,  $\pm 1$  least significant digit.

**Display:** Two 4-digit, 7 segment 0.56" high LED's.

**Display Resolution:** 1 count.

**Memory Backup:** Nonvolatile memory (no batteries required).

**Serial Communications:** Optional RS-232 or RS-485 with Modbus® protocol.

**Ambient Operating Temperature / RH:** 14 to 131°F (-10 to 55°C) / 0 to 90% up to 104°F (40°C) non-condensing, 10 to 50% at 131°F (55°C) non-condensing.

**Weight:** 16 oz (454 g).

**Front Panel Rating:** Meets UL Type 4X (IP66).

**Loop Power Supply (isolated):** 24 VDC @ 50 mA, regulated.

**Alarm On-Off Differential:** 1 count.

**Set Point Range:** Selectable.

**Power Voltage Stability:** 0.05% over the power voltage range.

**Temperature Stability:** 100 ppm / °C typical, 200 ppm / °C maximum.

**Common Mode Rejection:** 140 db minimum at 60 Hz.

**Normal Mode Rejection:** 65 db typical, 60 db at 60 Hz.

**Isolation:**

Relay: 1500 VAC to all other inputs and outputs;

24 VDC Loop Power: 500 VAC to other inputs and outputs;

Process Output: 500 VAC to other inputs and outputs.

**Storage Temperature:** -40 to 176°F (-40 to 80°C).

**Agency Approvals:** UL 508, CE.

# GETTING STARTED

1. Install the control as described on page 4.
2. Wire the control following the instructions on pages 5 through 7. Page 5 contains basic wiring for the control. If using the Series MPCJR's transmitter power supply follow the additional directions on page 6. Wiring instructions for the 232 and 485 series communication options is included on page 7.
3. Familiarize yourself with the front key pad functions and read the menu structure prior to starting the programming process. A programming chart with the menu structure and spaces to write your programming values is included on pages 26 through 28. This chart can be a helpful tool to save time in programming. For further assistance programming examples are included on pages 28 through 31.

## MODEL IDENTIFICATION

Model MPCJR -   
Options

### Options:

232	RS-232 Modbus®-RTU Serial Communications. Allows remote computer to read and write all control parameters.
485	RS-485 Modbus®-RTU Serial Communications. Allows remote computer to read and write all control parameters.
RV	Analog retransmission of input, 0 to 10 VDC.
RC	Analog retransmission of input, 0 (or 4) to 20 mA.

## Input Ranges

### Process Input Types

The 0 to 20 mA DC, 4 to 20 mA DC, 0 to 10 VDC, and 2 to 10 VDC inputs are fully scalable from a minimum of 100 count span placed anywhere within the range of -1999 to +9999. Decimal point position is adjustable from the zero place (9999), tenths (999.9), hundredths (99.99), or thousandths (9.999).

# INSTALLATION

Mount the instrument in a location that will not be subject to excessive temperature, shock, or vibration (see Specifications for specific tolerances). All models are designed for mounting in an enclosed panel.

Select the position desired for the instrument on the panel. Prepare the panel by cutting and deburring the required opening.

From the front of the panel, slide the housing through the cut out. The housing gasket should be against the housing flange before installing.

From the rear of the panel slide the mounting collar over the housing. Hold the housing with one hand and using the other hand, push the collar evenly against the panel until the springs are compressed. The ratchets will hold the mounting collar and housing in place.

**Figure 1 – Panel Cut Out Dimensions**

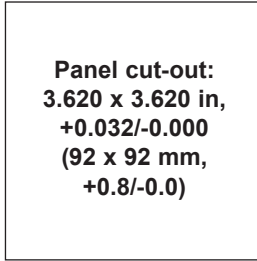

**CAUTION:** It is not necessary to remove the instrument chassis from the housing for installation. If the instrument chassis is removed from the housing, you must follow industry standard practice for control and protection against Electro-Static Discharge (ESD). Failure to exercise good ESD practices may cause damage to the instrument.

# WIRING

Do not run transmitter wiring or other Class 2 wiring in the same conduit as power leads. Use only the probe or transmitter for which the control has been programmed. Maintain separation between wiring of sensor, auxiliary in or out, and other wiring. See the "Secure Menu" for input selection.

Supply connections should be made in accordance with the National Electrical Code per Article 300, and local regulations. All line voltage output circuits must have a common disconnect and be connected to the same pole of the disconnect. Input wiring for probe or transmitter is rated CLASS 2. Control wiring is as shown in Figure 2 below.

## Figure 2 - Wiring

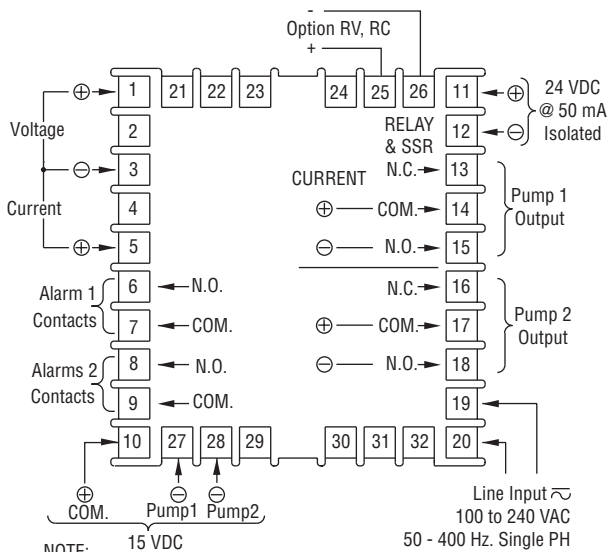

**NOTE:**

1. For supply connections use No. 16 AWG or larger wires rated for at least 75°C, or in accordance with an equivalent national standard.
2. Maximum ambient temperature rating 131°F (55°C)
3. Use copper conductors only
4. Terminals 1-5, 10-12, & 21-32 are class 2 'SELV'.

Line Input ~  
 100 to 240 VAC  
 50 - 400 Hz. Single PH  
 132 to 240 VDC 5VA  
 MAX. Output Ratings:  
 Relay: 10A. @ 240 VAC RES.  
 1/4 HP @ 120 VAC  
 1/3 HP @ 240 VAC  
 Alarm: 3A. @ 240 VAC RES.  
 P.D. 240VA, 120/240 VAC  
 SW. Volt.: 15 VDC @ 20 mA

290-3126

# WIRING FOR TRANSMITTER INPUTS USING INTEGRAL POWER SUPPLY

Wire power and outputs as shown on previous page. Wiring for two-wire transmitters shown below in Figure 3. All wiring shown in Figure 3 is Class 2.

**Figure 3 - Transmitter Wiring**

Use of a fuse (1/8W Fast-Blow) in the loop is recommended to protect the control input circuitry.

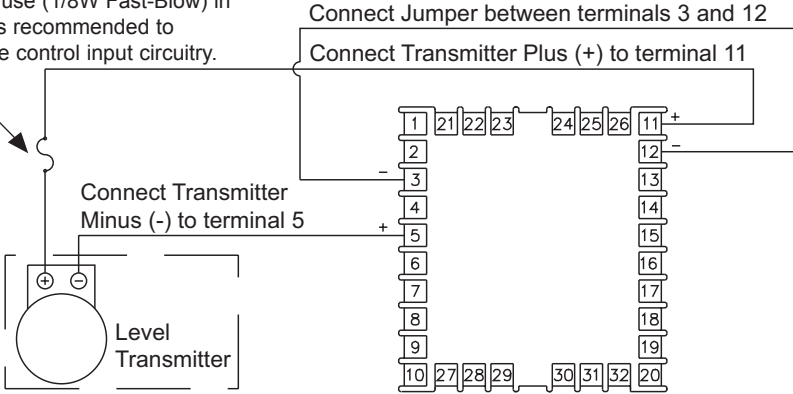

For three or four wire transmitters follow the wiring instructions provided with your transmitter.



**DO NOT wire the 24 Volt Power Supply across the input of the control. Damage to the control input circuitry will result.**

## USE OF SNUBBERS WITH INDUCTIVE LOADS

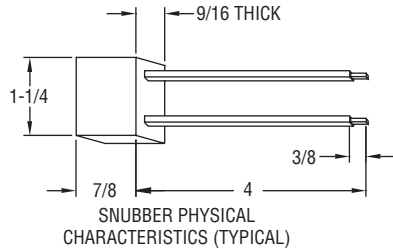
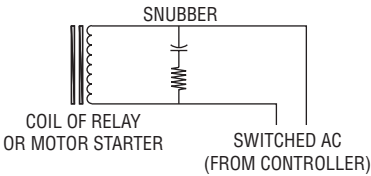

A snubber is a resistance/capacitance device that is used to reduce or eliminate high voltage spikes generated from inductive loads. For best effect, the snubber should be mounted as close to the coil as physically possible. Electrical and typical physical characteristics are shown above.



**Failure to use a snubber on an inductive load may cause erratic operation and/or premature relay contact wear.**

# WIRING FOR 485 AND 232 SERIAL COMMUNICATION OPTIONS

Wire power and outputs as shown on page 5. Wiring for options is shown in Figure 4 below. All wiring shown below is Class 2. Shielded twisted pair is recommended for Option 485.



**DO NOT** run signal wiring in the same conduit or chase as the power wiring. Erratic operation or damage to the control circuitry will result.

## Figure 4 – Wiring for Options

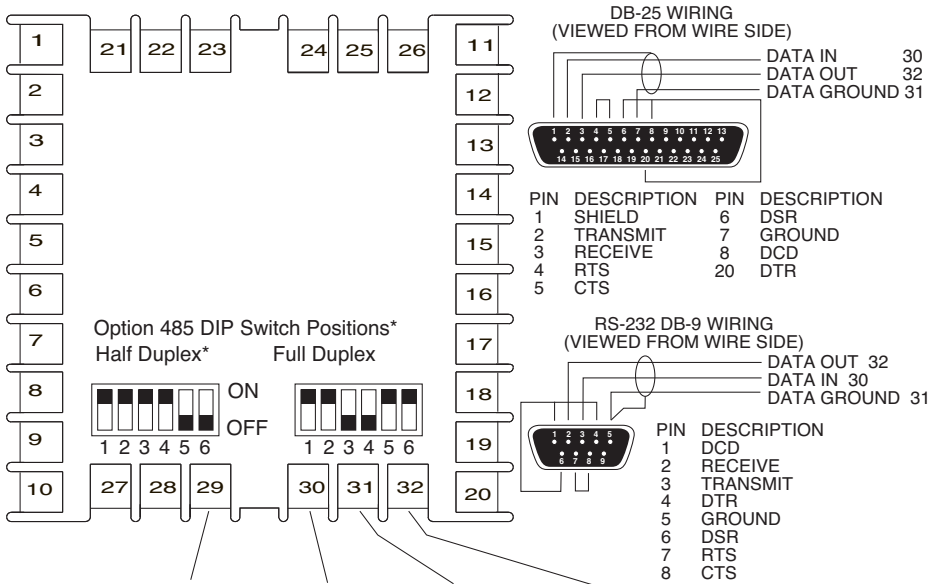

Terminal	29	30	31	32
Option 485	Y (receive -)	Z (receive +)	A (transmit -)*	B (transmit +)*
Option 232	not used	data out	data ground	data in

\*For half-duplex operation wire only A and B. Do not connect to Y and Z.



# FRONT PANEL FUNCTIONS

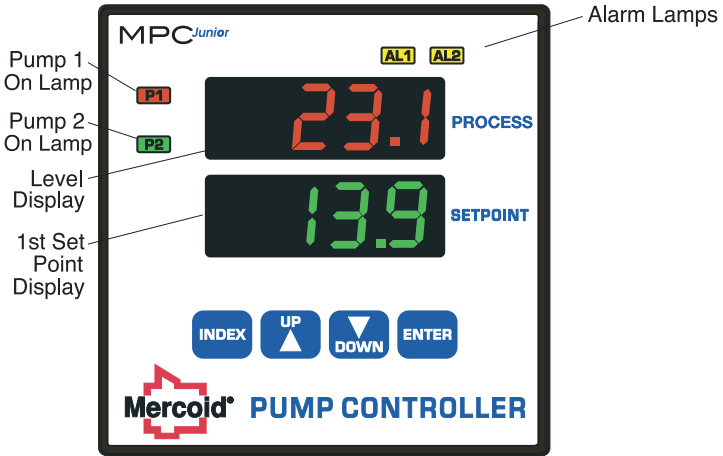

## Key functions are as follows:

**INDEX:** Pressing the **INDEX** key advances the display to the next menu item. May also be used in conjunction with other keys as noted below.

**UP ARROW:** Increments a value, changes a menu item, or selects the item to ON. The maximum value obtainable is 9999 regardless of decimal point placement.

**UP ARROW & ENTER:** Pressing these keys simultaneously brings up the secondary menu starting at the **SP1H** menu item. Pressing these keys for 5 seconds will bring up the secure menu.

**DOWN ARROW:** Decrements a value, changes a menu item, or selects the item to OFF. The minimum value obtainable is -1999 regardless of decimal point placement.

**ENTER:** The **ENTER** key is used to store the value of menu items once they are changed to a new value. If the **ENTER** key is not pressed after changing the value the item will revert to the previously stored value.



**INDEX & DOWN ARROW:** Pressing these keys simultaneously will allow backing up one menu item, or if at the first menu item they will cause the display to return to the primary menu. If an alarm condition has occurred, these keys may be used to reset the alarm.



**INDEX & ENTER:** Pressing these keys simultaneously and holding them for 5 seconds allows recovery from the various error messages. The following menu items will be reset:

ALiH: Alarm inhibit

CHEC CAL: Check calibration error

Correct the problems associated with the above conditions before using these reset keys. More than one error could be present. Caution is advised since several items are reset at one time.



## The Home Display



The home display is the normal display while the control is operating. If no errors or functions are active, the HOME display will indicate the Process Variable (the level that is being measured) on the top display and the SPIH value, Pump 1 On Set Point, on the bottom display.

Error messages may over-ride the HOME display. See ERROR MESSAGES on pages 21 and 22.

While in the **Secondary Menu**, if no key is pressed for a period of 30 seconds, the display will return to the HOME position displaying the process value. While in the **Secure Menu**, if no key is pressed for a period of 60 seconds, the display will return to the HOME position displaying the process value. Outputs are disabled (turned off) when the **Secure Menu** is active.

# Security Level Selection

Three levels of security are provided. The `SEC#` menu item security level may be viewed or changed at any time regardless of the present security level in the Secure menu. The display shows the current security level. To change security levels change the password value using the  UP ARROW or  DOWN ARROW keys and pressing the  ENTER key. Refer to the password table (following) for the correct value to enter for the security level desired.

To set the access level to, for example, 2, at the `SEC#` menu item press the  UP ARROW key until the upper display shows the password, 1101. Press the  ENTER key. The display will blink, and return with the level value, 2, in the upper display.

The password values shown in the table cannot be altered. Retain a copy of these pages for future reference. This is the only reference made to password values in this instruction book.

## Password Table

Menu	Security Level Status	Display Value When Viewed	Password Value to Enter
Secondary Secure	Locked Locked	2	1101
Secondary Secure	Unlocked Locked	3	1011
Secondary Secure	Unlocked Unlocked	4	111

## Lead/Lag Operation

The Mercoïd® MPCJR pump controller is designed to easily operate a pair of pumps in the most efficient manner possible. The controller has a 'lead/lag' feature that allows two pumps to operate in an alternating fashion to minimize wear.

The Mercoïd® MPCJR pump controller has a pair of set points each for pump 1 and pump 2. If the lead/lag feature is turned off,  $SP_{1H}$  and  $SP_{1L}$  control pump 1 and  $SP_{2H}$  and  $SP_{2L}$  control pump 2. If the lead/lag feature is turned on, pumps 1 and 2 will be controlled in the alternating fashion described below. In all cases the P1 lamp will indicate activity of pump 1 and the P2 lamp will indicate activity of pump 2. The lead/lag operation is set in the Secure menu with the item  $LdLg$ .

## Lead/Lag On

After installation, set the  $SP_{1H}$  to the high level (pump on point) for standard operation. Set  $SP_{1L}$  to the low level (pump off point). Set the  $SP_{2H}$  to the level where you want BOTH pumps to turn on (emergency pump on). Set the  $SP_{2L}$  to the level where you want the second pump to turn off (emergency pump off).

The controller will not allow you to set  $SP_{1H}$  below  $SP_{1L}$ ,  $SP_{1L}$  above  $SP_{1H}$ ,  $SP_{2H}$  below  $SP_{2L}$ , or  $SP_{2L}$  above  $SP_{2H}$ . The controller will not allow you to set any set point or alarm point above or below the programmed scale. No error messages are generated. The displayed value will stop at an allowable point just above (or below, as the case may be) the maximum or minimum allowed.

In normal operation, when the  $SP_{1H}$  point is reached, one of the pumps will turn on. When lead/lag is turned on, pumps 1 and 2 will alternate. If the level reaches the  $SP_{2H}$  point, both pumps will be turned on until the  $SP_{2L}$  point is reached, where one of the pumps will turn off. When  $SP_{1L}$  is reached, remaining running pump will turn off. The last pump off will not be the next pump on.

## Lead/Lag Off

If lead/lag is turned off,  $SP_{1H}$  and  $SP_{1L}$  control pump 1 and  $SP_{2H}$  and  $SP_{2L}$  control pump 2. There is no alternating function.

## OPERATION RV, RC ISOLATED ANALOG RETRANSMISSION

The analog retransmission option allows the Process Variable or the Set Variable to be sent as an analog signal to an external device. The signal may be either 0 to 10 VDC (Option RV) or 0 (or 4) to 20 mA DC (Option RC). The output may be changed in the field from one to the other by the toggle switch located on the top printed circuit board.

Wire the output as shown on page 5.

To set up the analog retransmission, first determine the scale range that the analog signal will represent. The maximum scale is 9999 counts. In the Secondary Menu set  $POL$  for the the scale value that will be represented by the low end of the analog signal (0 Volts or 0 mA). Set  $POH$  for the scale value that will be represented by the high end of the analog signal (10 Volts or 20 mA).

If you require a suppressed scale or output, you may use the following equations to determine the proper settings for  $POL$  and  $POH$ .

$K = (\text{Highest desired scale reading} - \text{Lowest desired scale reading}) / (\text{Maximum desired analog signal} - \text{Minimum desired analog signal})$ .

$POH = ((\text{Maximum possible analog output} - \text{Maximum desired analog signal}) * K) + \text{Highest desired analog reading}$ .

$POL = \text{Lowest desired scale reading} - ((\text{Minimum desired analog output}) * K)$ .

Operation is automatic. There are no further programming steps required.

## OPTION 232, 485 SERIAL COMMUNICATION OPERATION

The serial communications options allow the control to be written to and read from a remote computer or other similar digital device. Communication is allowed either through a RS-485 (Option 485) port, or a RS-232 (Option 232) port.

Wire the communication lines as shown on Page 7. Wiring for the RS-485 is run from control to control in a daisy chain fashion with a termination resistor (120 ohms) across the transmit and receive terminals of the last control in the chain. Set the RS-485 DIP switch for half or full duplex as appropriate for your application. The DIP switch is located on the communications board plugged into the center of the bottom board of the control.

Select the control address and communication baud rate with the `ADDR` and `BAUD` menu items in the Secure Menu. THE BAUD RATE AND ADDRESS MENU ITEMS WILL TAKE EFFECT ON THE NEXT POWER UP OF THE CONTROL. BE SURE TO POWER CYCLE THE CONTROL BEFORE USING THE NEW BAUD RATE AND ADDRESS.

In operation, you have the option of preventing a write command from the host computer. To prevent the host from writing to the control change the `LOCK` menu item in the Secondary Menu to `LOC`. To allow the host to write commands to the control set `LOCK` to `RE`. (The host does have the ability to change the `LOCK` state, but it is not automatic.)

If your system depends on constant reading or writing to and from the host, you may wish to set the No Activity Timer (`NAT`) to monitor the addressing of the control. When the `LOCK` is set to `RE` and the `NAT` is set to any value other than `OFF`, the control will expect to be addressed on a regular basis. If the control is not addressed in the time set by the value of `NAT`, then the control will display the error message `CHEC LOCK`. To clear the message set `LOCK` to `LOC`.

## MENU SELECTIONS







### Notation Conventions for the Menu

Because of the number of features available in this control, information is included that may not apply to your specific control. All usable features are included in this book, but may not be used in your process. To increase clarity the following conventions are used:

1. Certain features or functions shown in this book are contextual. This means that Menu Items may or may not appear, depending on other Menu Item selections. Whenever this occurs, a notation is made in the Menu Item that "controls" or "directs" other menu items. If you are looking for a particular menu item and can't find it, check the menu item that is its "control" for proper setting.

2. The "#" symbol is used in two ways. It is used inside a group of characters to indicate which set point function (SP1 or SP2) is being affected. It is also used before a group of characters of a menu item to indicate that there may be more than one selection or value for that menu item.

### Secondary Menu

Press the  UP ARROW and  ENTER keys to start the menu. Press  INDEX to advance to the next menu item. Press  UP ARROW or  DOWN ARROW to change the value in the display. Press  ENTER to retain the value.

SP1H Pump 1 On Set Point. Factory Default 23.1 (feet).

SP1L Pump 1 Off Set Point. Factory Default -5.7 (feet).







SP2H Pump 2 On Set Point. Factory Default 23.1 (feet).



SP2L Pump 2 Off Set Point. Factory Default -5.7 (feet).

AL1Hi Alarm 1 High: Factory Default 23.1 (feet).

AL2Lo Alarm 2 Low: Factory Default 2.0 (feet).

## Secure Menu

Press the  UP ARROW and  ENTER keys for 5 Seconds to start the menu. Press  INDEX to advance to the next menu item. Press  UP ARROW or  DOWN ARROW to change the value in the display. Press  ENTER to retain the value. OUTPUTS ARE DISABLED (TURNED OFF) WHILE CONTROL IS IN THE SECURE MENU.

- SECr** Security Code: See the Security Level Selection and the Password Table on page 10, in order to enter the correct password. Factory Default is 4.
- InP** Input Type: Select one of the following. Refer to the Input wiring section for the proper wiring. Factory Default is **Cur**.
- Cur** DC Current Input 0.0 to 20.0 or 4.0 to 20.0 mA.
  - Vol+** DC Voltage Input 0.0 to 10.0 or 2.0 to 10.0 volts.
  - - - -** Reserved
- InPC** Input Correction: Select  $\pm 500$  counts. This feature allows the input value to be changed to agree with an external reference or to compensate for sensor error. Note: **InPC** is reset to zero when the input type is changed, or when decimal position is changed.
- LdLg** Lead / Lag: Select **On** or **OFF**. Factory default is **On**. (See page 11).
- On** The Lead/Lag function is enabled. The outputs of SP1 and SP2 will alternate.
  - OFF** The Lead/Lag function is disabled.
- OSUP** Zero Suppression: Select **On** or **OFF**. Factory default is **OFF**.
- OFF** The input range will start at 0 (zero) Input.
  - On** The input range will start at 4.00 mA or 2.00 V.
- dPT** Decimal Point Positioning: Select **0**, **0.0**, **0.00**, or **0.000**. All Menu items related to the input will be affected. Factory default is **0.0**.
- PER** The Peak feature stores the highest input the control has measured since the last reset or Power On. At Power On **PER** is reset to the present input. To manually reset the value **PER** must be in the lower display. Press the  ENTER key to reset. **PER** will be reset and display the present input value.
- VAL** The Valley feature stores the lowest input the Controller has measured since the last reset or Power On. At Power On **VAL** is reset to the present input. To manually reset the value **VAL** must be in the lower display. Press the  ENTER key. **VAL** will be reset and display the present input value.



- SCAL** Scale Low: Select 100 to 9999 counts below SCAH. The total span between SCAL and SCAH must be within 11998 counts. Maximum setting range is -1999 to +9999 counts. Factory Default is -5.7.
- SCAH** Scale High: Select 100 to 9999 counts above SCAL. The total span between SCAL and SCAH must be within 11998 counts. Maximum setting range is -1999 to +9999 counts. Factory Default is 23.1.
- SPL** Set Point Low: Select from the lowest input range value to SPH value. This will set the minimum SP1L or SP2L value that can be entered. The value for SP1L or SP2L will stop moving when this value is reached. Factory Default is -5.7.
- SPH** Set Point High: Select from the highest input range value to SPL value. This will set the maximum SP1H or SP2H value that can be entered. The value for SP1H or SP2H will stop moving when this value is reached. Factory Default is 23.1.
- S1S+** Set Point 1 State: Select P<sub>in</sub> or P<sub>Out</sub>. Factory default is P<sub>Out</sub>.
- P<sub>in</sub> Pump In (Direct Action). As the input increases the output will increase.
- P<sub>Out</sub> Pump Out (Reverse Action). As the input increases the output will decrease.
- S1LP** P1 Lamp: Select 0<sub>on</sub> or 0<sub>off</sub>. Factory default is 0<sub>on</sub>.
- 0<sub>on</sub> Lamp ON when Output is ON.
- 0<sub>off</sub> Lamp OFF when Output is ON.
- S2S+** Set Point 2 State: Select P<sub>in</sub>, P<sub>Out</sub> or OFF. Factory default is P<sub>Out</sub>.
- P<sub>in</sub> Pump In (Direct Action). As the input increases the output will increase.
- P<sub>Out</sub> Pump Out (Reverse Action). As the input increases the output will decrease.
- S2LP** P2 Lamp: Select 0<sub>on</sub> or 0<sub>off</sub>. Factory default is 0<sub>on</sub>.
- 0<sub>on</sub> Lamp ON when Output is ON.
- 0<sub>off</sub> Lamp OFF when Output is ON.

# ALARM TYPE AND ACTION

**CAUTION:** In any critical application where failure could cause expensive product loss or endanger personal safety, a redundant limit controller is required.



When setting an alarm value for an absolute alarm ( $R1+ = Rb5$  or  $R2+ = Rb5$ ), simply set the value at which the alarm is to occur.

When setting the alarm value for a deviation alarm ( $R1+ = dE$  or  $R2+ = dE$ ), set the difference in value from the Set Point ( $SP1H$ ) desired.

Since the input for the MPCJR is driven from a transmitter, the input display can be programmed in different ways. Regardless of the position of the decimal point, a change of one in the right most digit is referred to as a count. For example, if there were no decimal point selected, a change from 235 to 236 is a change of one count. If the decimal point were selected at 0.0, a change of 23.5 to 23.6 is a change of one count.

The following diagram (below) shows the action and reset functions for both absolute and deviation alarms.

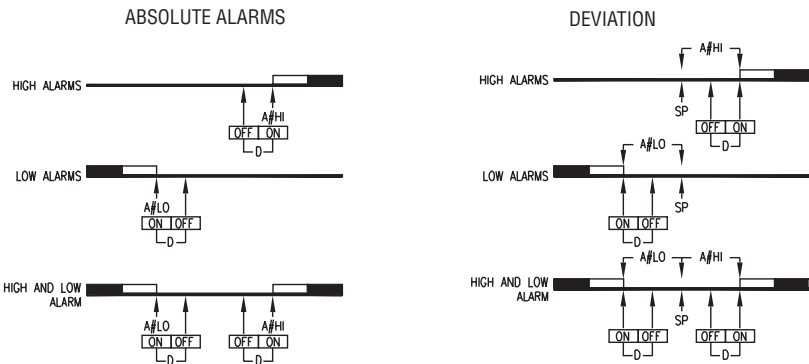

When setting up an alarm for deviation the deviation is set in counts. For example if a low alarm is required to be 5 counts below the  $SP1H$ , then set  $A\#L_0$  to -5. If a high alarm is required 20 counts above the  $SP1H$ , then set  $A\#H_i$  to +20. If  $SP1H$  is changed, the alarm will continue to hold the same relationship as originally set.

When Alarm Power Interrupt,  $A\#P_i$ , is programmed ON and Alarm Reset,  $A\#_E$ , is programmed for Hold, the alarm will automatically reset upon a power failure and subsequent restoration if no alarm condition is present.

If Alarm Inhibit,  $A\#iH$ , is selected ON, an alarm condition is suspended upon power up until the process value passes through the alarm set point once. Alarm inhibit can be restored as if a power up took place by pressing both the **INDEX** and

**ENTER** ENTER keys for 5 seconds.







**WARNING:** IF INHIBIT IS ON AND A POWER FAILURE OCCURS DURING A HIGH ALARM, RESTORATION OF POWER WILL NOT CAUSE THE ALARM TO OCCUR IF THE PROCESS VALUE DOES NOT FIRST DROP BELOW THE HIGH ALARM SETTING. DO NOT USE THE ALARM INHIBIT FEATURE IF A HAZARD IS CREATED BY THIS ACTION. BE SURE TO TEST ALL COMBINATIONS OF HIGH AND LOW ALARM INHIBIT ACTIONS BEFORE PLACING CONTROL INTO OPERATION.

The following menu items apply only to the alarms.

- AL 1 Alarm 1 function: Select OFF, Lo, Hi, or HiLo, Factory default is Hi.
- OFF Alarm 1 is disabled. No Alarm 1 menu items appear in the Secondary or Secure menus.
  - Lo Low Alarm Only. ALLo appears in the Secondary Menu.
  - Hi High Alarm Only. ALHi appears in the Secondary Menu.
  - HiLo High and Low Alarms. Both ALLo and ALHi appear in the Secondary Menu, and share the same Alarm 1 Relay output.

If AL1 is set to OFF, go to AL2 on the next page.

- AL+ Alarm 1 Type: Select Abs or dE. Factory default is Abs.
- Abs Absolute Alarm that may be set anywhere within the values of SCAL and SCRH and is independent of SPIH.
  - dE Deviation Alarm that may be set as an offset from SPIH. As SPIH is changed the Alarm Point will track with SPIH.
- ALrE Alarm 1 Reset: Select OnOFF or Hold. Factory default is OnOFF.
- OnOFF Automatic Reset.
  - Hold Manual Reset. Reset (acknowledge) by simultaneously pressing the  INDEX &  DOWN ARROW keys for 5 seconds.
- ALPi Alarm 1 Power Interrupt: Select On or OFF. Factory default is OFF.
- On Alarm Power Interrupt is On.
  - OFF Alarm Power Interrupt is OFF.
- ALiH Alarm 1 Inhibit: Select On or OFF. Factory default is OFF.
- On Alarm Inhibit is On. Alarm action is suspended until the process value first enters a non-alarm condition.
  - OFF Alarm Inhibit is OFF.
- ALi+ Alarm 1 Output State: Select CLOS or OPEn. Factory default is CLOS.
- CLOS Closes Contacts at Alarm Set Point.
  - OPEn Opens Contacts at Alarm Set Point.

- ALP** Alarm 1 Lamp: Select  $\square_{ON}$  or  $\square_{OFF}$ . Factory default is  $\square_{ON}$ .  
 $\square_{ON}$  Alarm Lamp is ON when alarm contact is closed.  
 $\square_{OFF}$  Alarm Lamp is OFF when alarm contact is closed.
- AL2** Alarm 2 function: Select OFF, Lo, Hi, or HiLo. Factory default is Lo.  
 OFF Alarm 2 is disabled. No Alarm 2 menu items appear in the Secondary or Secure menus.  
 Lo Low Alarm Only.  $A2Lo$  appears in the Secondary Menu.  
 Hi High Alarm Only.  $A2Hi$  appears in the Secondary Menu.  
 HiLo High and Low Alarms. Both  $A2Lo$  and  $A2Hi$  appear in the Secondary Menu, and share the same Alarm 2 Relay output.
- If AL2 is set to OFF the remaining A2, alarm 2, menu items do not appear.
- A2+** Alarm 2 Type: Select ABS or dE. Factory default is ABS.  
 ABS Absolute Alarm that may be set anywhere within the values of SCAL and SCRH and is independent of SPIH.  
 dE Deviation Alarm that may be set as an offset from SPIH. As SPIH is changed the Alarm Point will track with SPIH.
- A2rE** Alarm 2 Reset: Select  $\square_{NOF}$  or Hold. Factory default is  $\square_{NOF}$ .  
 $\square_{NOF}$  Automatic Reset.  
 Hold Manual Reset. Reset (acknowledge) by simultaneously pressing the  INDEX &  DOWN ARROW keys for 5 seconds.
- A2Pi** Alarm 2 Power Interrupt: Select  $\square_{ON}$  or OFF. Factory default is OFF.  
 $\square_{ON}$  Alarm Power Interrupt is ON.  
 OFF Alarm Power Interrupt is OFF.
- A2 iH** Alarm 2 Inhibit: Select  $\square_{ON}$  or OFF. Factory default is OFF.  
 $\square_{ON}$  Alarm Inhibit is On. Alarm action is suspended until the process value first enters a non-alarm condition.  
 OFF Alarm Inhibit is OFF.
- A2S+** Alarm 2 Output State: Select CLOS or OPEN. Factory default is CLOS.  
 CLOS Closes Contacts at Alarm Set Point.  
 OPEN Opens Contacts at Alarm Set Point.
- A2LP** Alarm 2 Lamp: Select  $\square_{ON}$  or  $\square_{OFF}$ . Factory default is  $\square_{ON}$ .  
 $\square_{ON}$  Alarm Lamp is ON when alarm contact is closed.  
 $\square_{OFF}$  Alarm Lamp is OFF when alarm contact is closed.

**FIL+** Digital Filter: Select OFF or 1 to 99. In some cases the time constant of the sensor, or noise could cause the display to jump enough to be unreadable. If this value is set too high, controllability will suffer. Factory default is 3.

The remaining menu items appear if the corresponding option was purchased with the control.

**POL** (Analog Retransmission Output, see page 13) Process Output Low: Select -1999 counts to any value less than POH. Factory default is -5.7.

**POH** (Analog Retransmission Output, see page 13) Process Output High: Select from any value greater than POL to 9999 counts. Factory default is 23.1.

**LOC/E** (Option 232 and 485, Serial Communications) Local / Remote Status: Select LOC or rE. Factory default is rE.

**LOC** The host computer is advised not to send remote commands. Any write commands sent to the controls will be rejected.

**rE** The host computer is allowed to send write commands. If the control is not addressed within the time set in the nAt (No Activity Timer, see Secure Menu) the CHECK LOC/E error message will be displayed.

**Addr** (Option 232 or 485, Serial Communications) Control Address: Set from 1 to FF. This number (hexadecimal, base 16) must match the address number used by the host computer. Factory default is 32.

**baud** (Option 232 or 485, Serial Communications) Communication Baud Rate: Select 300, 1200, 2400, 4800, 9600, or 19200. This number must match the baud rate used by the host computer. Factory default is 9600.

**nAt** (Option 232 or 485, Serial Communications) No Activity Timer: Set from OFF or 1 to 99 minutes. Factory default is OFF.

**1 - 99** Maximum time between host computer accesses. If timer counts to 0, CHECK/ LOC/E will be displayed.

**OFF** No Activity Timer function is disabled.

## DIAGNOSTIC ERROR MESSAGES

DISPLAY	MEANING	SP OUTPUTS	ACTION REQUIRED
No display lighted	Display is blank. Instrument is not getting power, or the supply voltage is too low.	Set point outputs inactive Alarms inactive	Check that the power supply is on, or that the external fuses are good.
FAIL +ES+	Fail test appears upon power up if the internal diagnostics detect a failure. This message may occur during operation if a failure is detected. Displays flash.	Set point outputs inactive Alarms inactive	The display alternates between FAIL +ES+ and one of the following messages: FAC+ dFL+: Memory may be corrupted. Press the ENTER key and the DOWN ARROW key to start the factory default procedure. Recheck controller programming. rEt FAC+: Unrecoverable error, return to factory for service.
CHEC LoRE	This message appears if the Serial Communications has timed out.	Set point outputs active Alarms inactive	Restore the communications line and switch the LoRE to L0C.

# DIAGNOSTIC ERROR MESSAGES

DISPLAY	MEANING	SP OUTPUTS	ACTION REQUIRED
UFL or OFL	Underflow or Overflow: Process value has exceeded input range ends.	Set point outputs active Alarms active	Input signals may normally go above or below range ends. If not, check input and correct.
CHEC CAL	Check calibration appears as an alternating message if the instrument calibration nears tolerance edges.  Check calibration appears as a flashing message if the instrument calibration exceeds specification.	Set point outputs active Alarms active  Set point outputs inactive Alarms active	Remove the instrument for service and / or recalibration. To reset use the INDEX & ENTER keys.  Remove the instrument for service and / or recalibration. To reset use the INDEX & ENTER keys.
A-ER (Alternates with PV)	This message appears if the ambient temperature of the control approaches the ends of tolerance.	Set point outputs active Alarm active	Correct the ambient temperature conditions. Ventilate the area of the cabinet or check for clogged filters. If RJC broken, return to factory for service.
A-ER	This message appears if the ambient temperature of the control is out of range or RJC sensor is broken.	Set point outputs active Alarms active	Correct the ambient temperature conditions. Ventilate the area of the cabinet or check for clogged filters. If RJC broken, return to factory for service.

## PROGRAMMING CHART

Use the charts on this and the next page to record the values in your application. You may want to photocopy the pages if you plan to make programming changes.

MENU	ITEM	DEFAULT	SET AT	DESCRIPTION
Primary	PU SP 1H			Home Position, Process Variable & SP1H's Value displayed

MENU	ITEM	DEFAULT	SET AT	DESCRIPTION
Secondary	SPIH	23.1		Set Point 1 value (default is in feet)
	SP1L	-5.7		Set Point 1 off value (default is in feet)
	SP2H	23.1		Set Point 2 value (default is in feet)
	SP2L	-5.7		Set Point 2 off value (default is in feet)
	AlHi	23.1		Alarm 1 (high) value (default is in feet)
	AlLo	2.0		Alarm 2 (low) value (default is in feet)

MENU	ITEM	DEFAULT	SET AT	DESCRIPTION
Secure	SECr	4		Security Selection
	InP	Curr		Input (selectable current or voltage)
	InPC	0.0		Input Correction
	LdLg	On		Lead/Lag (selectable on or off)
	OSUP	OFF		Zero Suppression (selectable on or off)
	dPt	0.0		Decimal Point Positioning
	PEA	XX		Peak, highest input value seen since last reset
	VAL	XX		Valley, lowest input value seen
	SCAL	-5.7		Scale Low value (default is in feet)
	SCAH	23.1		Scale High value (default is in feet)
	SPL	-5.7		Set Point Low value (default is in feet) since last reset
	SPH	23.1		Set Point High value (default is in feet)
	SIS+	POut		Set Point 1 State (selectable POut (Pumping Out) or PIn (Pumping In))
	SiLP			Set Point 1 Lamp Condition when contact is closed (selectable on or off)
	S2S+	POut		Set Point 2 State (selectable POut (Pumping Out), PIn (Pumping In), or off)
S2LP			Set Point 2 Lamp Condition when contact is closed (selectable on or off)	

Continued on next page



MENU	ITEM	DEFAULT	SET AT	DESCRIPTION
Secure	AL1	Hi		Alarm 1 Function (selectable off, lo, hi, or hilo)
	AL+	ABS		Alarm Type 1 (selectable abs (absolute) or de (deviation))
	ALrE	ONOF		Alarm 1 Reset (selectable onof (auto) or hold (manual))
	ALPi	OFF		Alarm 1 Power Interrupt (selectable on or off)
	ALiH	OFF		Alarm 1 Inhibit (selectable on or off)
	ALST	CLOS		Alarm 1 Output State (selectable close or open)
	ALLP	On		Alarm 1 Lamp condition when contact is closed (selectable on or off)
	AL2	LO		Alarm 2 function (selectable off, lo, hi, or hilo)
	AL2+	ABS		Alarm 2 Type (selectable abs (absolute) or de (deviation))
	AL2rE	ONOF		Alarm 2 Reset (selectable onof (auto) or hold (manual))
	AL2Pi	OFF		Alarm 2 Power Interrupt (selectable on or off)
	AL2iH	OFF		Alarm 2 Inhibit (selectable on or off)
	AL2ST	CLOS		Alarm 2 Output State (selectable close or open)
	AL2LP	On		Alarm 2 Lamp condition when contact is closed (selectable on or off)
	FL+	3		Digital Filter
	POL	-5.7		Process Output Low (default is in feet)
	POH	23.1		Process Output High (default is in feet)
	LOrE	rE		Local/Remote for computer communications
	Addr	32		Control Address for computer communications
	BAUD	9600		Baud Rate for computer communications
nAT	OFF		No Activity Timer for computer communications	
Stor	YES		Store Menu for Hi speed writes (selectable yes or no)	

# PROGRAMMING EXAMPLE

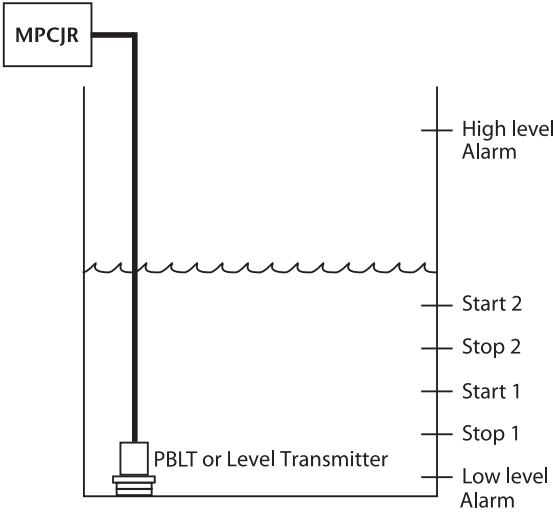

Example:

- Keep Empty, two pump (duplex)
- Depth 25 feet
- Pump 1: Start at 6 feet  
Stop at 3 feet
- Pump 2: Start at 12 feet  
Stop at 9 feet
- Low level alarm: 1 foot, fixed, auto reset
- High level alarm: 20 feet, fixed, auto reset
- Want Lead/Lag function on
- No communication options
- Want 4-20 mA retransmission
- Using with a 4-20 mA input.

## EXAMPLE PROGRAMMING CHART

MENU	ITEM	DEFAULT	SET AT	DESCRIPTION
Secondary	SP1H	23.1	6.0	Set Point 1 value (default is in feet)
	SP1L	-5.7	3.0	Set Point 1 off value (default is in feet)
	SP2H	23.1	12.0	Set Point 2 value (default is in feet)
	SP2L	-5.7	9.0	Set Point 2 off value (default is in feet)
	AL1H	23.1	20.0	Alarm 1 (high) value (default is in feet)
	AL2L	2.0	1.0	Alarm 2 (low) value (default is in feet)

**EXAMPLE PROGRAMMING CHART** continued

MENU	ITEM	DEFAULT	SET AT	DESCRIPTION
Secure	SECr	4	4	Security Selection
	InP	Curr	Curr	Input (selectable current or voltage)
	InPC	0.0	0.0	Input Correction
	LdLg	On	On	Lead/Lag (selectable on or off)
	0SUP	OFF	On	Zero Suppression (selectable on or off)
	dPt	0.0	0.0	Decimal Point Positioning
	PEA	XX		Peak, highest input value seen since last reset
	URL	XX		Valley, lowest input value seen
	SCAL	-5.7	0.0	Scale Low value (default is in feet)
	SCAH	23.1	25.0	Scale High value (default is in feet)
	SPL	-5.7		Set Point Low value (default is in feet) since last reset
	SPH	23.1		Set Point High value (default is in feet)
	S1St	POut		Set Point 1 State (selectable POut (Pumping Out) or PIn (Pumping In))
	S1LP			Set Point 1 Lamp Condition when contact is closed (selectable on or off)
	S2St	POut	POut	Set Point 2 State (selectable POut (Pumping Out), PIn (Pumping In), or off)
S2LP			Set Point 2 Lamp Condition when contact is closed (selectable on or off)	

## EXAMPLE PROGRAMMING CHART continued

MENU	ITEM	DEFAULT	SET AT	DESCRIPTION
Secure	AL I	Hi	Hi	Alarm 1 Function (selectable off, lo, hi, or hilo)
	A L+	AbS	AbS	Alarm Type 1 (selectable abs (absolute) or de (deviation))
	A 1rE	OnOF	OnOF	Alarm 1 Reset (selectable onof (auto) or hold (manual))
	AlPi	OFF	OFF	Alarm 1 Power Interrupt (selectable on or off)
	AlIH	OFF	OFF	Alarm 1 Inhibit (selectable on or off)
	AlST	CLOS	CLOS	Alarm 1 Output State (selectable close or open)
	AlLP	On	On	Alarm 1 Lamp condition when contact is closed (selectable on or off)
	AL2	LO	LO	Alarm 2 function (selectable off, lo, hi, or hilo)
	A2+	AbS	AbS	Alarm 2 Type (selectable abs (absolute) or de (deviation))
	A2rE	OnOF	OnOF	Alarm 2 Reset (selectable onof (auto) or hold (manual))
	A2Pi	OFF	OFF	Alarm 2 Power Interrupt (selectable on or off)
	A2IH	OFF	OFF	Alarm 2 Inhibit (selectable on or off)
	A2S+	CLOS	CLOS	Alarm 2 Output State (selectable close or open)
	A2ULP	On	On	Alarm 2 Lamp condition when contact is closed (selectable on or off)
	FIL+	3	3	Digital Filter
	POL	-5.7	0.0	Process Output Low (default is in feet)
POH	23.1	25.0	Process Output High (default is in feet)	



**MERCOID**  
**A Division of Dwyer Instruments, Inc.**

P.O. BOX 258 • MICHIGAN CITY, INDIANA 46361, U.S.A.

Phone: 219/879-8000 • Fax: 219/872-9057

www.dwyer-inst.com • e-mail: lit@dwyer-inst.com