

BEKO

BEKO

*installation, operation &
food storage instructions*

**7.4 cu.ft.
Upright
Freezer**

Model
TZDA 503



get the best from your new refrigerator

BEKO plc
Beko House
Caxton Way
Watford
Hertfordshire
WD18 8UF
Tel: 0845 6004911
Fax: 0845 6004922
e-mail: service@beko.co.uk
website: www.beko.co.uk

Printed in Turkey

Part no: 48 6370 00 00

Congratulations on your choice of a **BEKO** quality Appliance which has been designed to give you service for many years.

**WARNING !
IMPORTANT !**

DO NOT connect your appliance to the electricity supply until all packing and transit protectors have been removed.

- Leave to stand for at least 4 hours before switching on to allow compressor oil to settle if transported horizontally.
- If you are discarding an old refrigerator with a lock or latch fitted to the door, disable the lock/latch, ensure that it is left in a safe condition to prevent the entrapment of young children.
- This freezer must only be used for its intended purpose i.e. the storing and freezing of edible foodstuff.
- Do not dispose of the appliance on a fire. At BEKO, the care and protection of our environment is an ongoing commitment. This appliance which is among the latest range introduced is particularly environment friendly. Your appliance contains non CFC / HFC natural substances in the cooling system (Called R600a) and in the insulation(Called cyclopentane) which are potentially flammable if exposed to fire. Therefore, take care not to damage, the cooling circuit / pipes of the appliance in transportation and in use. In case of a damage do not expose the appliance to fire, potential ignition source and immediately ventilate the room where the appliance is situated.
- We suggest you contact your local authority for disposal information and facilities available.
- To obtain the best possible performance and trouble free operation from your appliance it is very important to carefully read these instructions.
- On delivery, check to make sure that the product is not damaged and that all the parts and accessories are in perfect condition.
- Ensure that the plug remains readily accessible. Do not use multiple adapter bar or extension cable.
- Failure to observe these instructions may invalidate your right to free service during the guarantee period.

WARNING- Keep ventilation openings, in the appliance enclosure or in the built-in structure, clear of obstruction.

WARNING- Do not use mechanical devices or other means to accelerate the defrosting process, other than those recommended by the manufacturer.

WARNING- Do not damage the refrigerant circuit.

WARNING- Do not use electrical appliances inside the food storage compartments of the appliance, unless they are of the type recommended by the manufacturer.

- We suggest you keep these instructions in a safe place for easy reference.
- This appliance is not intended for use by persons (including children) with reduced physical, sensory or mental capabilities, or lack of experience and knowledge, unless they have been given supervision or instruction concerning use of the appliance by a person responsible for their safety.
- Children should be supervised to ensure that they do not play with the appliance.

	BEKO Upright Freezer TZDA 503
PERFORMANCE	
Energy efficiency class	A
Energy consumption - Kwh/year	254
Net storage - vol frozen food ltrs (cu.ft)	175 (6.2)
Total net vol - ltrs (cu.ft.)	175 (6.2)
Frozen food compartment rating	4 STAR
Conservation time from failure	25 hrs.
Freezing capacity fresh food - kg (lb) /24 hrs.	11 (24.2)
Climate class	SN
Operating noise level dB(A)	38

CONTENTS

PAGE

SAFETY FIRST / ELECTRICAL REQUIREMENTS	3
TRANSPORTATION INSTRUCTIONS	4
INSTALLATION INSTRUCTIONS	5
STARTING	6
TEMPERATURE CONTROL AND ADJUSTMENT	7
STORING FROZEN FOOD	8
FREEZING FRESH FOOD	9
MAKING ICE CUBES	10
DEFROSTING	10
CLEANING AND CARE	11
DO'S AND DON'TS	12
PROBLEM SOLVING/ TROUBLE SHOOTING	12
REVERSING THE DOOR	13-14
GUARANTEE DETAILS	15
HOW TO OBTAIN SERVICE	16

ELECTRICAL REQUIREMENTS

Before you insert the plug into the wall socket make sure that the voltage and the frequency shown in the rating plate inside the appliance corresponds to your electricity supply. Rating label is on the left hand side of the freezer liner. We recommend that this appliance is connected to the mains supply via a suitable switched and fused socket. The socket must be in an accessible position. Should the mains lead of the appliance become damaged or should it need replacing at any time, it must be replaced by a special purpose made mains lead which can only be obtained from a BEKO Authorised Service Agent.

WARNING! THIS APPLIANCE MUST BE EARTHED

If the fitted moulded plug is not suitable for your socket, then the plug should be cut off and an appropriate plug fitted. Destroy the old plug which is cut off as a plug with bared cord could cause a shock hazard if inserted into a socket elsewhere in the house.

The moulded plug on this appliance incorporates a 13 A fuse. Should the fuse need to be replaced an ASTABEAB approved BS 1362 fuse of the same rating must be used. Do not forget to refit the fuse cover. In the event of losing the fuse cover the plug must not be used until a replacement fuse cover has been fitted. Colour of the replacement fuse cover must be the same colour as that visible on the pin face of the plug. Fuse covers can be obtained from a BEKO authorised service agent.

IMPORTANT! FITTING A DIFFERENT PLUG

As the colours of the wires in the mains lead of this appliance may not correspond with the coloured markings identifying the terminals in your plug proceed as follows: (See diagram).

1. Connect the green-yellow or green (Earth) wire to the terminal in the plug marked 'E' or with the symbol  or coloured green and yellow or green.
2. Connect the blue (Neutral) wire to the terminal in the plug marked 'N' or coloured black.
3. Connect the brown (Live) wire to the terminal in the plug marked 'L' or coloured red.

With alternative plugs a 13 A fuse must be fitted either in the plug or adaptor or in the main fuse box.

If in doubt contact a qualified electrician.

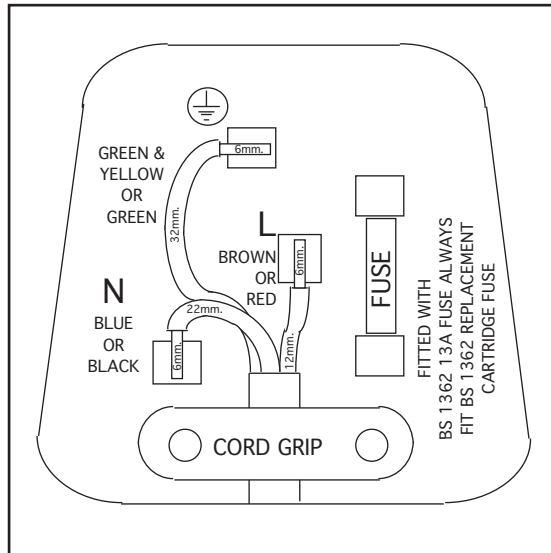

TRANSPORTATION INSTRUCTIONS

1. The freezer should be transported only in a vertical upright position. The packing as supplied must be intact during transportation.
2. If during the course of transport the appliance has to be transported horizontally, the product must only be laid on its left hand side (when facing the door front) and it must not be operated for at least 4 hours to allow the system to settle after the appliance is brought back to upright position.
3. Failure to comply with the above instructions could result in damage occurring to the freezer. The manufacturer will not be held responsible if these instructions are disregarded.
4. The freezer must be protected against rain, moisture and other atmospheric influences.
5. When positioning your appliance take care not to damage your flooring, pipes, wall coverings etc. Do not move the appliance by pulling by the door or handle.

IMPORTANT : Care must be taken while cleaning / carrying the appliance to avoid touching the bottom of the condenser metal support or pipework at the back of the appliance as you might injure your fingers and hands or damage your product.

IMPORTANT : This appliance is not designed for stacking with any other appliance.

Do not attempt to sit or stand on top of your appliance as it is not designed for such use. You could injure yourself or damage the appliance.

IMPORTANT : Make sure that mains cable is not caught under the appliance during and after carrying / moving the appliance, to avoid the mains cable becoming cut or damaged.

Do not allow children to play with the appliance or tamper with the controls. BEKO plc declines to accept any liability should the instructions not be followed.

IMPORTANT INSTALLATION INSTRUCTIONS

1. The space in the room where the appliance is installed must not be smaller than 10 cubic metres.
2. If possible avoid placing the appliance near cookers, radiators or in direct sunlight as this will cause the compressor to run for long periods. If installed next to a source of heat or refrigerator, maintain the following minimum side clearances:

From Cookers	2" (50 mm)
From Radiators	12" (300 mm)
From Refrigerators or Larder Fridge	1" (25 mm)

3. Make sure that sufficient room is provided around the appliance to ensure free air circulation. Allow a minimum of 60 mm (2.4 inches) between the top of the appliance and the ceiling or the underside of a wall cupboard.
4. Fit the two plastic wall spacers supplied with the appliance rotating 1/4 turn to the condenser at the back of the appliance (See diagram).
5. The appliance should be located on a smooth surface.

The two front feet can be adjusted as required.

To ensure that your appliance is standing upright adjust the two front feet by turning clockwise or anti-clockwise, until the product is in firm contact with the floor. Correct adjustment of feet avoids excessive vibration and noise.

6. Refer to "Cleaning and Care" section to prepare your appliance for use.
7. A special receptacle is supplied to store the mains plug during transit. The receptacle is fixed at the back of the cabinet, on the right hand side of the compressor. (See diagram) Gently remove the plug from the receptacle. Never pull the mains cord, you may damage the appliance. In the case of transportation, ensure you locate the plug in the receptacle provided to avoid transit damage.

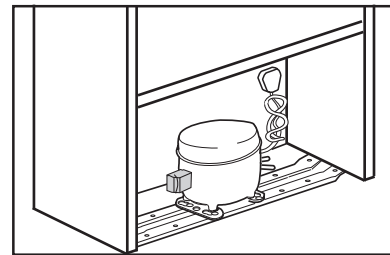
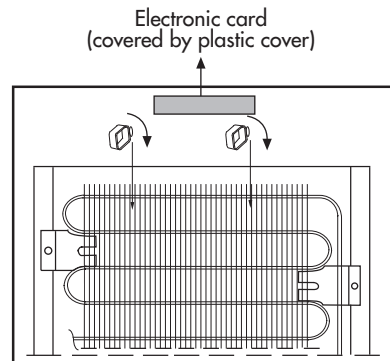

STARTING

Final Check

Before you start using the freezer check that:

1. The feet have been adjusted for perfect levelling.
2. The interior is dry and air can circulate freely.
3. Clean the interior as recommended under "CLEANING AND CARE."
4. Insert the plug into the wall socket and switch on the electricity supply.
5. You will hear a noise as the compressor starts up. The liquid and gases sealed within the refrigeration system may also give rise to noise, whether the compressor is running or not which is quite normal.
6. We recommend that you set the thermostat knob at 3 (three) and monitor the temperature to ensure the appliance maintains desired storage temperatures (See section Temperature Control and Adjustment).
7. Do not load the appliance immediately it is switched on. Wait until the correct storage temperature has been reached. We recommend that you check the temperature with an accurate thermometer (see; Temperature Control and Adjustment).

Important Notes :

1. If there is a power failure do not open the door. Frozen food should not be affected if the failure lasts for less than 25 hours. If the failure is longer, then the food should be checked and either eaten immediately or cooked and then re-frozen.
2. If you find the freezer door difficult to open just after you have closed it, don't worry. This is due to the pressure difference which will equalise and allow the door to open normally after a few moments.
3. You will hear a suction sound just after closing the door. This is quite normal.

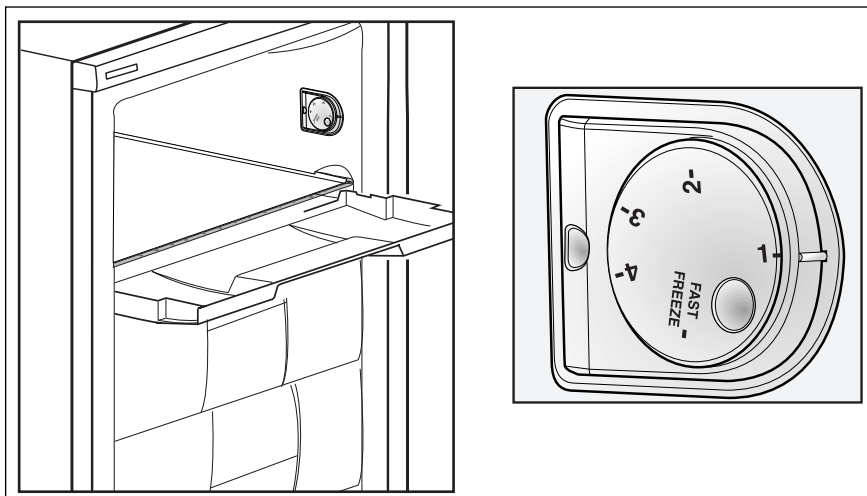

STORING FROZEN FOOD

Prepacked commercially frozen food should be stored in accordance with the frozen food manufacturer's instructions for a ❄️ frozen food storage compartment.

To ensure that the high quality achieved by the frozen food manufacturer and the food retailer is maintained the following should be remembered:

1. Put packets in the freezer as quickly as possible after purchase.
2. Do not exceed "Use By", "Best Before" dates on the packaging.
3. For hygiene reasons, always wrap food using a suitable packaging material before storing in your appliance to avoid contact with the appliance surface.

TEMPERATURE CONTROL AND ADJUSTMENT

The operating temperature is regulated by the temperature control.

1 = Lowest cooling setting (Warmest setting)

Fast Freeze = Highest cooling setting (Coldest setting)

Please choose the setting according to the desired temperature.

The interior temperature also depends on ambient temperature, the frequency with which the door is opened and the amount of food kept inside.

Frequently opening the door causes the interior temperature to rise.

For this reason, it is recommended to close the door again as soon as possible after use.

The normal storage temperature of your appliance should be $-18\text{ }^{\circ}\text{C}$ ($0\text{ }^{\circ}\text{F}$). If the thermostat knob is turned counter clockwise from position 1. Lower temperatures can be obtained by adjusting the thermostat knob towards position Fast Freeze. We recommend checking the temperature with a thermometer to ensure that the storage compartments are kept to the desired temperature. Remember to take the reading immediately since the thermometer temperature will rise very rapidly after you remove it from the freezer.

FREEZING FRESH FOOD

Freezing capacity of your appliance in a 24 hours period is 11 kg (24.2 lb). Never exceed this maximum capacity.

If large amounts of fresh food are going to be frozen, adjust the control knob to Fast Freeze. 24 hours before putting the fresh food in the fast freeze compartment.

It is strongly recommended to keep the knob at Fast Freeze position at least 24 hours to freeze maximum amount of fresh food declared as freezing capacity.

Take special care not to mix already frozen food and fresh food.

If the fast freeze compartment (2) is filled with fresh food, other compartments can also be used to freeze fresh food. Ice-bank (3) has been specially designed to obtain ice cubes (see making Ice Cubes).

1. Thermostat knob
2. Fast freeze compartment
3. Ice bank
4. Drawers
5. Adjustable front feet
6. Ice cube tray

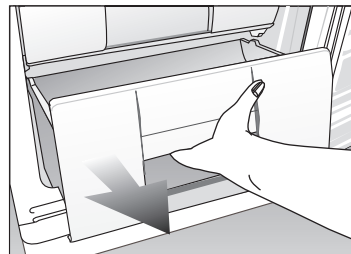
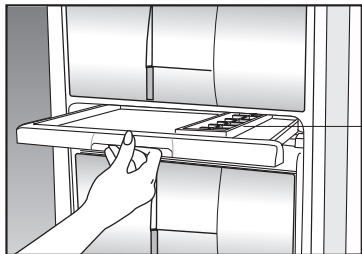
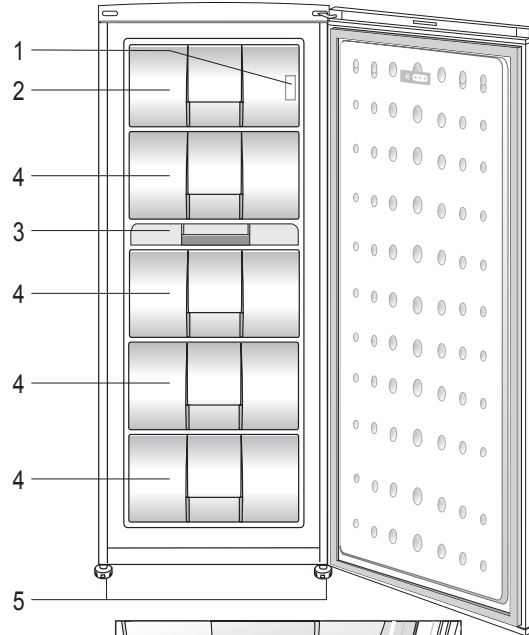

Icebank and drawers are all removable.

MAKING ICE CUBES

Fill the ice-cube tray 3/4 full with water and place it on the special Ice Bank. Store ice-cubes in the Ice Bank.

DEFROSTING

Defrost twice a year or when a frost layer of around 7 mm (1/4") has formed. To start defrosting procedure switch off the freezer at the socket outlet and pull out the mains plug.

All food should be wrapped in several layers of newspaper and stored in a cool place (e.g. fridge or larder).

Remove all freezer baskets. Fold out the spout, place a bowl underneath the spout to collect the water. Ensure you use a bowl large enough to contain the defrost water. Normally the volume of the bowl should be about 4 (four) litres. Leave the freezer door open.

Containers full of warm water may be placed carefully in the freezer to speed up the defrosting.

Do not use pointed or sharp edged objects such as knives, forks to remove the frost.

Never use hairdryers, electrical heaters and other similar electrical appliances for defrosting.

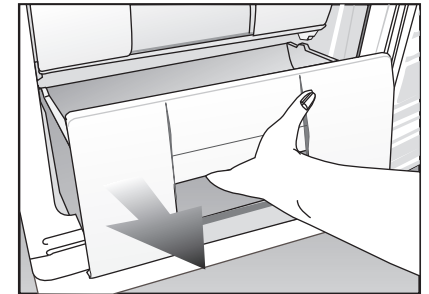

When defrosting has finished, fold back the spout and dry the interior thoroughly. Turn the setting knob to fast freeze. Remove the bowl and Empty it. Close the freezer door. Insert the plug into the wall socket and switch on the electricity supply. Don't forget to tape over the switch to avoid accidental disconnection. Remember to turn the setting knob back to its previous position once food has frozen.

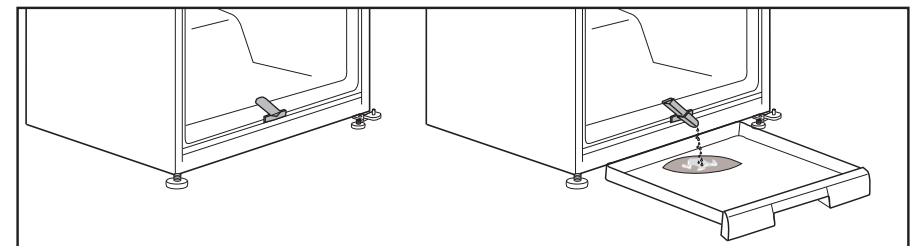

CLEANING AND CARE

- ** We recommend that you switch off the freezer at the socket outlet and pull out the mains plug before cleaning.
- ** Never use any sharp abrasive instrument, soap, household cleaner, detergent and wax polish for cleaning.
- ** Use luke warm water to clean the cabinet of the freezer and wipe it dry.
- ** Use a damp cloth wrung out in a solution of one teaspoon of bicarbonate of soda to one pint of water to clean the interior and wipe it dry.
- ** If the freezer is not going to be used for a long period of time switch it off, remove all food, clean it and leave the door ajar.
- ** To remove a drawer, pull it as far as possible, and then tilt it upwards, and then pull it out completely.
- ** Any dust that gathers on the condenser, which is located at the back of the freezer, should be removed once a year with a vacuum cleaner.
- ** Check door seals regularly to ensure they are clean and free from food particles.

DO'S AND DON'TS

- Do- Check contents of the freezer at regular intervals.
- Do- Clean your freezer regularly.
- Do- Keep food for as short a time as possible and adhere to "Best Before", "Use By" dates.
- Do- Store commercially frozen food in accordance with the instructions given on the packets that you buy.
- Do- Always choose high quality fresh food and be sure it is thoroughly clean before you freeze it.
- Do- Prepare fresh food for freezing in small portions to ensure rapid freezing.
- Do- Wrap all food in aluminium foil or freezer quality polythene bags and make sure any air is excluded.
- Do- Wrap frozen food when you buy it and put it in to the freezer as soon as possible.
- Do- Separate food in the compartments. This will enable you to find food quickly and avoid excessive door opening therefore save electricity.
- Do- Remove ice cream from the freezer 10-20 minutes before serving.
- Don't- Leave the door open for long periods as this will make the freezer more costly to run.
- Don't- Put hot food into the freezer. Let it cool down first.
- Don't- Put liquid-filled bottles or sealed cans containing carbonated liquids into the freezer as they may burst.
- Don't- Store poisonous or dangerous substances in the Freezer. Your freezer has been designed for the storage of edible foodstuffs only.
- Don't- Exceed the maximum freezing capacity (11 kg in any 24 hours) when freezing fresh food.
- Don't- Consume ice-cream and water ices direct from the freezer. The low temperature may cause 'freezer burns' on lips.
- Don't- Freeze fizzy drinks.
- Don't- Try to keep frozen food which has thawed, it should be eaten within 24 hours or cooked and refrozen.
- Don't- Remove items from the freezer with wet hands.
- Don't- Close the door before placing the fast-freeze compartment cover in its place.
- Don't- Leave frozen food at room temperature to thaw; the best way to defrost food is to put it in the fridge to thaw slowly. Make sure you avoid defrosting food or food juices drip onto other food.
- Don't- Remove the plastic cover on the rear wall.
- Don't- Damage the pipes on the appliance.

PROBLEM SOLVING / TROUBLE SHOOTING

If the appliance does not operate when switched on, check:

- The plug is inserted properly in the socket and that the power supply is on. (To check the power supply to the socket, plug in another appliance)
- The fuse has blown/circuit breaker has tripped/main distribution switch has been turned off.
- The temperature control has been set correctly.
- New plug is wired correctly if you have changed the fitted moulded plug.

If the appliance is still not operating after the above checks, please refer to the section on "How To Obtain Service".

Please ensure that above checks have been made as a charge will be made if no fault is found.

REVERSING THE DOOR

We recommend that you reverse the door before switching on for the first time.

Tools required: Small and medium size flat and cross-headed screwdrivers, a pair of pliers.

Spare Parts supplied in the plastic bag: The following parts, which are exclusively for left hand side fitted hinge operation are supplied in a plastic bag with the appliance:

- Door top trim hinge covers – there are 2 different parts, one for each side of top trim.

We suggest you keep all the parts supplied in the plastic bag and also parts, which have been removed when reversing the door, in a safe place for possible future, re-use.

IMPORTANT: We suggest you ask somebody to help you when moving the appliance around and to hold the door when removing / re-fitting hinges and the door to avoid any injury and damage to the product.

Please refer to diagrams supplied. To follow numbers in brackets below, refer to the main diagram.

1. Switch off the appliance at the socket outlet and pull out the mains plug.
2. Remove all loose items and fittings and food inside the appliance.
3. Gently prise off plastic hinge covers on both sides of front top panel using a small flat-headed screwdriver. (1-2)
4. Unscrew the bolts of the top hinge and remove top hinge. (3)
5. Remove door carefully off the bottom hinge and stand door upright in a safe place. (4)
6. Gently prise off plastic hinge cover on door top trim. Fit the other door top trim plastic off hinge cover supplied in the plastic bag. (5)
7. Gently tilt the appliance back against a strong wall on its rear side sufficiently to allow the lower hinge to be removed. Take care to protect the appliance, your wall and floor coverings. You can utilise the original packaging to do this. Once you tilt the appliance back, check to make sure the appliance is completely stable and safe before you carry on. (6)
8. Unscrew and remove the front feet and 1 bolt. (7)
9. Unscrew and remove the bottom hinge. (8)
10. Unscrew and remove the bottom hinge door stopper and bushing and reposition them on the other side while rotating the bushing 180°. (9)
11. Fit the bottom hinge and tighten the screws as shown in figure. (10)
12. Fit the other front feet as shown in figure. (11)
13. Rotate the top hinge 180°. Unscrew the hinge pin and re-tighten it to the opposite side. (12)
14. Fit the top hinge on the left hand side bushing of the door. (13)
15. Locate and re-fit door to bottom hinge pin. (14)
16. Re-fit the upper hinge on the opposite side by using a flat headed screwdriver. (15)
17. Fit front top panel plastic hinge covers on the opposite sides. (16)
18. Adjust the two front feet if necessary.
19. Check that door opens and closes easily, it is aligned correctly and there are no gaps allowing air into the cabinet. If there are gaps between the door seal and the cabinet, adjust the door seal by gently pulling away from the door using fingers.
20. Check that all the hinge screws are tightened. Avoid over tightening the screws.
21. Put all items, fittings back in the appliance.
22. Wait for at least 4 hours to allow the system to settle before switching on.
23. Once the correct storage temperatures have been reached in the appliance, put back all the food.

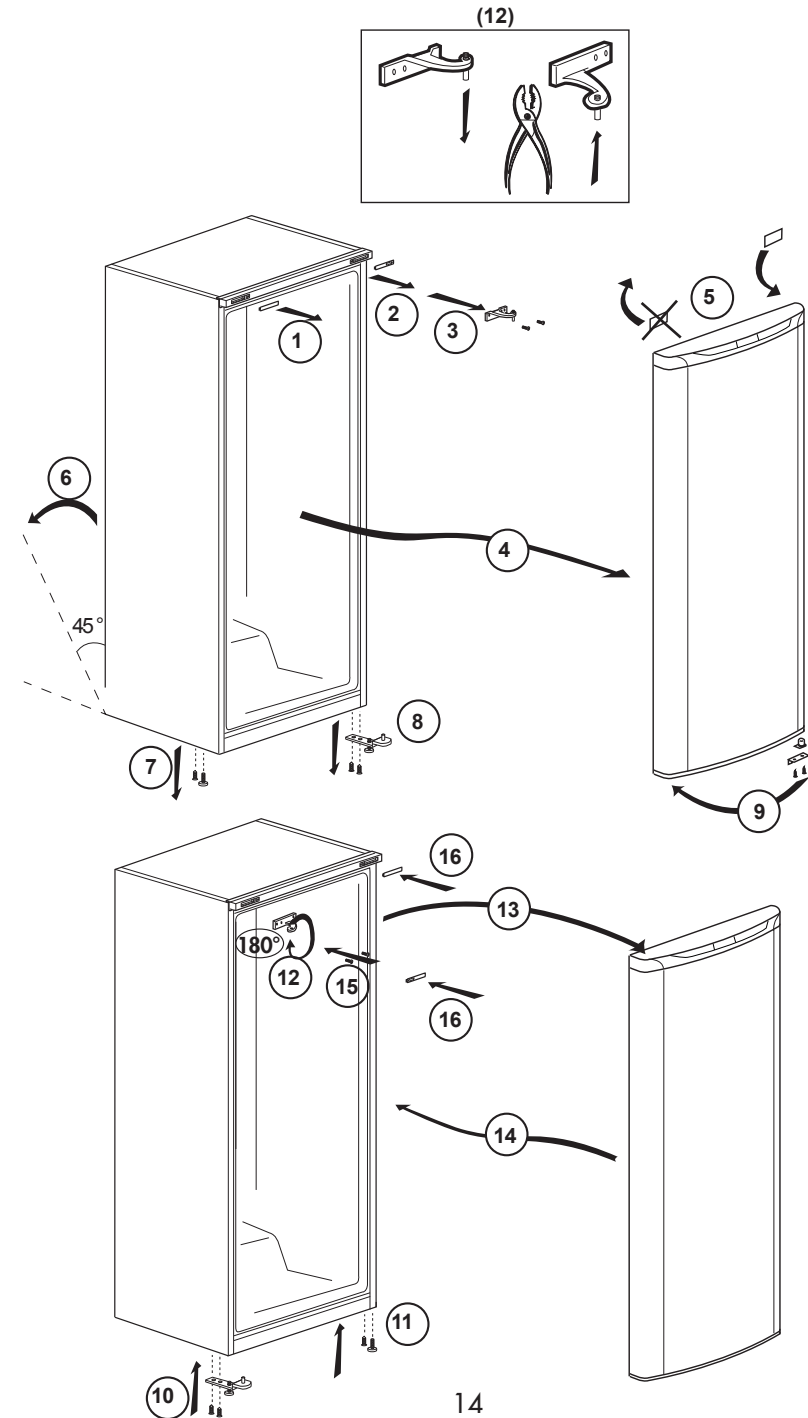

GUARANTEE DETAILS

Your new Beko product is guaranteed against the cost of breakdown repairs for twelve months from the date of the original purchase.

What is covered?

- Repairs necessary as a result of faulty materials, defective components or manufacturing defect.
- The cost of functional replacement parts, but excluding consumable items.
- The labour costs of a Beko approved repairer to carry out the repair.

What is not covered?

- Transit, delivery or accidental damage or misuse and abuse.
- Cabinet or appearance parts, including knobs, flaps, handles or container lids.
- Accessories or consumable items including but not limited to, ice trays, scrapers, cutlery baskets, filters and light bulbs.
- Repairs required as a result of unauthorised repair or inexperienced installation that fails to meet the requirements contained in the user instruction book.
- Repairs to products used on commercial or non-residential household premises.
- Loss of frozen food in freezers or fridge/freezers. (Food loss insurance is often included within your household contents insurance policy, or may be available separately from your retailer).

Important notes.

- Your Beko product is designed and built for domestic household use only.
- The guarantee will be void if the product is installed or used in commercial or non-residential domestic household premises.
- The product must be correctly installed, located and operated in accordance with the instructions contained in the User Instructions Booklet provided.
- Professional installation by a qualified Electrical Domestic Appliance Installer is recommended for all Washing Machines, Dishwashers and Electric Cookers
- Gas Cookers must only be installed by a CORGI (or BORD GAIS) registered Gas Installer.
- The guarantee is given only within the boundaries of the United Kingdom and the Republic of Ireland.
- The guarantee is applicable only to new products and is not transferable if the product is resold.
- Beko disclaims any liability for incidental or consequential damages. The guarantee does not in anyway diminish your statutory or legal rights.

HOW TO OBTAIN SERVICE

Please keep your purchase receipt or other proof of purchase in a safe place; you will need to have it should the product require attention under guarantee.

You should also complete the details below; it will help us assist you when requesting service. (The model number is printed on the Instruction Booklet and the serial number is printed on the Rating Label affixed to the appliance)

Model No: Serial No: Retailer: Date of purchase:

For service under guarantee simply telephone the appropriate number below

UK Mainland & Northern Ireland

Fridges & Freezers	0845 6004903
Electric Cookers	0845 6004902
Gas & Dual Fuel Cookers	0845 6004905
Washing Machines & Dishwashers	0845 6004906

Republic of Ireland

All Refrigeration, All Cookers Washing Machines & Dishwashers	01 862 3411
--	-------------

Before requesting service please check the trouble-shooting guide in the Operating Instructions as a charge may be levied where no fault is found even though your product may still be under guarantee.

Service once the manufacturers guarantee has expired.

If you have purchased an extended guarantee please refer to the instructions contained within the extended guarantee agreement document. Otherwise please call the appropriate number above where service can be obtained at a charge.

Should you experience any difficulty in obtaining service please contact the Beko Customer Help-Line. Tel: 0845 6004911 e-mail: service@beko.co.uk



This product bears the selective sorting symbol for waste electrical and electronic equipment (WEEE). This means that this product must be handled pursuant to European Directive 2002/96/EC in order to be recycled or dismantled to minimize its impact on the environment. For further information, please contact your local or regional authorities.

Electronic products not included in the selective sorting process are potentially dangerous for the environment and human health due to the presence of hazardous substances.