

PLEASE THINK BEFORE YOU PRINT

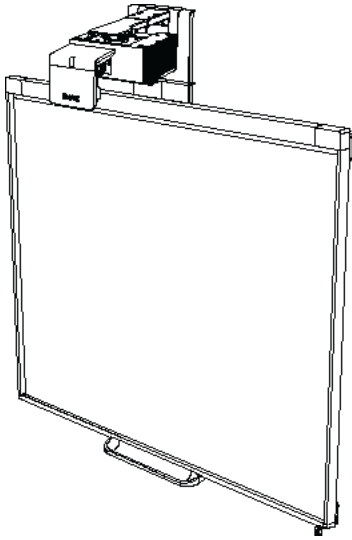

SMART Board™ 480i5 Interactive Whiteboard System User's Guide

Extraordinary made simple™

SMART™

Copyright Notice

© 2011 SMART Technologies ULC. All rights reserved. No part of this publication may be reproduced, transmitted, transcribed, stored in a retrieval system or translated into any language in any form by any means without the prior written consent of SMART Technologies ULC. Information in this manual is subject to change without notice and does not represent a commitment on the part of SMART.

Trademark Notice

SMART Board, DVIT, smarttech, the SMART logo and all SMART taglines are trademarks or registered trademarks of SMART Technologies ULC in the U.S. and/or other countries. Texas Instruments, Brilliant Color, DLP and DLP Link are Trademarks of Texas Instruments. HDMI is a trademark or registered trademark of HDMI Licensing LLC. Phillips is a registered trademark of Phillips Screw Company. Microsoft, Windows and Internet Explorer are either registered trademarks or trademarks of Microsoft Corporation in the U.S. and/or other countries. Blu-ray is a trademark of the Blu-ray Disc Association. All other third-party product and company names may be trademarks of their respective owners.

FCC Warning

This equipment has been tested and found to comply with the limits for a Class A digital device, pursuant to Part 15 of the FCC Rules. These limits are designed to provide reasonable protection against harmful interference when the equipment is operated in a commercial environment. This equipment generates, uses and can radiate radio frequency energy and, if not installed and used in accordance with the manufacturer's instructions, may cause harmful interference to radio communications. Operation of this equipment in a residential area is likely to cause harmful interference in which case the user will be required to correct the interference at his own expense.

Copyright Notice

Patents. US5448263; US6141000; US6337681; US6421042; US6540366; US6563491; US6674424; US6747636; US6760009; US6803906; US6829372; US6954197; US7184030; US7236162; US7289113; US7342574; US7379622; US7532206; US7619617; US7626577; US7692625; US7751671; CA2058219; CA2386094; EP1297488; EP1739528; JP4033582; JP4052498; JP4057200; ZL0181236.0; DE60124549; Other patents pending.

Important information

Before you install and use your SMART Board™ 480i5 interactive whiteboard system, read and understand the safety warnings and precautions in this user's guide and the included warnings document. These safety warnings and precautions describe the safe and correct operation of your interactive whiteboard system and its accessories, helping you to prevent injuries and equipment damage. Ensure that your interactive whiteboard system is always being used correctly.

In this document, "SMART Board 480i5 interactive whiteboard system" refers to your SMART Board 480 interactive whiteboard and its SMART UF75 projector, accessories and optional equipment.

The SMART UF75 projector included with your system is designed to work only with certain SMART Board interactive whiteboard models. Contact your authorized SMART reseller (smarttech.com/wheretobuy) for more information.

Safety warnings, cautions and important information

WARNING

- Failure to follow the installation instructions shipped with your SMART product could result in personal injury and damage to the product.
- To reduce the risk of fire or electric shock, do not expose the SMART product to rain or moisture.
- Two people are required to mount your SMART product because it may be too heavy for one person to safely maneuver.

When you lift your interactive whiteboard, you and your assistant should stand on either side of the screen, supporting its weight at the bottom while balancing the top with your other hands.

- When mounting the projector boom on a framed or hollow wall, attach both the mounting bracket and the safety tether to a stud to safely support the projector's weight. If you use only drywall anchors, the drywall can fail, resulting in product damage and possible personal injury.

IMPORTANT INFORMATION

- Do not leave cables on the floor where they can be a tripping hazard. If you must run a cable over the floor, lay it in a flat, straight line and secure it to the floor with tape or a cable management strip of a contrasting color. Handle cables carefully and avoid excessive bending.
- Do not climb (or allow children to climb) on a wall- or stand-mounted SMART Board interactive whiteboard.

Do not climb on, hang from or suspend objects from the projector boom.

Climbing on the interactive whiteboard or projector boom could result in personal injury or product damage.



CAUTION

- Do not operate this unit immediately after moving it from a cold location to a warm location. When the unit is exposed to such a change in temperature, moisture can condense on the lens and crucial internal parts. Allow the system to stabilize to room temperature before operation to prevent possible damage to the unit.
- Do not place the unit in hot locations, such as near heating equipment. Doing so could cause a malfunction and shorten the life of the projector.
- Avoid setting up and using the SMART product in an area with excessive levels of dust, humidity and smoke.
- Do not place your SMART product in direct sunlight or near any appliance that generates a strong magnetic field.
- You must connect the USB cable that came with your SMART Board interactive whiteboard to a computer that has a USB compliant interface and that bears the USB logo. In addition, the USB source computer must be compliant with CSA/UL/EN 60950 and bear the CE mark and CSA and/or UL Mark(s) for CSA/UL 60950. This is for operating safety and to avoid damage to the SMART Board interactive whiteboard.
- Do not block the projector's ventilation slots and openings.
- Avoid putting the projector into Standby mode during the lamp ignition phase because this can lead to premature lamp failure. Keep the projector lamp on for a minimum of 15 minutes before putting it into Standby mode to preserve the lamp life.
- Cycling power to the projector repeatedly can lock or damage your SMART product. After you put the product into Standby mode, wait at least 15 minutes for cooling before starting the product again.

IMPORTANT INFORMATION

- Do not adjust any settings in the service menu other than those listed in the following procedures. Changing other settings might damage or affect the operation of your projector and invalidates your warranty.
- If dust or small items prevent pen tray buttons from being pressed or cause constant button contact, remove the obstructions carefully.
- Before you clean the SMART UF75 projector, press the **Power**  button twice on the remote control or projector to put the system into Standby mode, and then allow the lamp to cool for 45 minutes.
- Do not spray cleaners, solvents or compressed air near any part of the projector because they can damage or stain the unit. Spraying the system could spread a chemical mist on some of the projector's components and lamp, resulting in damage and poor image quality.
- Do not allow liquids or commercial solvents of any kind to flow into the projector.
- When transporting your SMART product, repack it with as much of the original packaging as possible. This packaging was designed with optimal shock and vibration protection.
- If your SMART product requires replacement parts, make sure the service technician uses replacement parts specified by SMART Technologies or parts with the same characteristics as the original.



IMPORTANT

- Use the instructions included with your SMART UF75 projector to install your interactive whiteboard and projector. The instructions in your SMART Board interactive whiteboard box do not include instructions for installing the SMART UF75 projector.
- Make sure an electrical socket is near your SMART product and remains easily accessible during use.
- Using your SMART product near a TV or radio could cause interference to the images or sound. If this happens, move the TV or radio away from the projector.
- If you have peripheral devices that do not use a 4-pin mini-DIN connector or an RCA composite video jack, or if your device has an audio connection that does not use RCA jacks, you may need to purchase third-party adapters.
- Keep your remote control in a safe place because there is no other way to access menu options.
- Put your SMART product into Standby mode before cleaning it.

IMPORTANT INFORMATION

- Follow these guidelines to clean the projector:
 - Wipe the exterior of the projector with a lint-free cloth.
 - If necessary, use a soft cloth moistened with a mild detergent to clean the projector housing.
 - Do not use abrasive cleaners, waxes or solvents.
 - Avoid touching the lens. If it is necessary to clean the lens:
 - Use liquids or commercial solvents (such as glass cleaners) to clean the lens, but do not spray them directly on the system.
 - Use protective gloves and dip a lint-free cloth (such as Purestat PW2004) in an anti-static solvent (such as Hyperclean EE-6310).
 - Gently wipe the lens from the center to the edge.
- Disconnect the product from its power source when it's not used for a long period.

Environmental requirements

Before installing your SMART Board 480i5 interactive whiteboard system, review the following environmental requirements.

Environmental requirement	Parameter
Operating temperature	<ul style="list-style-type: none">• 5°C to 35°C (41°F to 95°F) from 0 m to 1800 m (0' to 6000')
Storage temperature	<ul style="list-style-type: none">• -20°C to 40°C (-4°F to 104°F)
Humidity	<ul style="list-style-type: none">• 30% to 80% relative humidity, non-condensing
Water and fluid resistance	<ul style="list-style-type: none">• Intended for indoor use only. Doesn't meet any salt-spray or water ingress requirements.• Don't pour or spray liquids directly onto your interactive whiteboard, the SMART UF75 projector or any of its sub-components.
Dust	<ul style="list-style-type: none">• Designed for pollution degree 1 (P1) as per EN61558-1, which is defined as "No pollution or only dry non-conductive pollution"
Electrostatic discharge (ESD)	<ul style="list-style-type: none">• EN61000-4-2 severity level 4 for direct and indirect ESD• No malfunction or damage up to 8kV (both polarities) with a 330 ohm, 150 pF probe (air discharge)• Unmated connectors meet no malfunction or damage up to 4kV (both polarities) for direct (contact) discharge
Cables	<ul style="list-style-type: none">• All SMART Board 480i5 interactive whiteboard system cables should be shielded to prevent potential accidents and degraded video and audio quality.
Conducted and radiated emissions	<ul style="list-style-type: none">• EN55022/CISPR 22, Class A

Contents

Important information	i
Safety warnings, cautions and important information.....	i
Environmental requirements.....	v
About your interactive whiteboard system	1
SMART Board 480i5 interactive whiteboard system features.....	2
Included accessories.....	3
Optional accessories.....	4
Installing your interactive whiteboard system	5
Choosing a location.....	6
Choosing a height.....	6
Routing the cables.....	7
Installing SMART software.....	8
Securing the interactive whiteboard system.....	8
Using your interactive whiteboard system	9
Using your projector.....	9
Using your interactive whiteboard.....	21
Integrating other devices	23
Video format compatibility.....	23
Connecting peripheral sources and outputs.....	25
Maintaining your interactive whiteboard system	27
Maintaining your interactive whiteboard.....	27
Cleaning the projector.....	27
Focusing and adjusting the projector image.....	28
Replacing the projector lamp.....	29
Troubleshooting your interactive whiteboard system	35
Correcting image alignment issues.....	36
Diagnosing issues using the interactive whiteboard system indicators and controls.....	36
Resolving network communication issues.....	40
Resolving audio issues.....	41
Resolving video issues.....	41
Resolving image issues.....	42
Accessing the service menu.....	45
Locating serial numbers.....	46

CONTENTS

Transporting your interactive whiteboard system	47
Remotely managing your interactive whiteboard system	49
Web page management	50
Connecting your room control system to the SMART UF75 projector	54
Projector programming commands	56
Simple Network Management Protocol (SNMP)	67
Hardware environmental compliance	69
Waste Electrical and Electronic Equipment regulations (WEEE directive)	69
Restriction of Certain Hazardous Substances (RoHS directive)	69
Batteries	69
Packaging	70
China's Electronic Information Products regulations	70
U.S. Consumer Product Safety Improvement Act	70
Customer support	71
Online information and support	71
Training	71
Technical support	71
Shipping and repair status	71
General inquiries	72
Warranty	72
Registration	72
Index	73

Chapter 1

About your interactive whiteboard system

SMART Board 480i5 interactive whiteboard system features.....	2
SMART Board 480 interactive whiteboard.....	2
SMART UF75 projector.....	3
Included accessories.....	3
Pen.....	3
Remote control.....	4
Optional accessories.....	4

Your SMART Board 480i5 interactive whiteboard system combines the wall-mounted, short-throw SMART UF75 projector with a SMART Board 480 interactive whiteboard.

This chapter describes the features of your SMART Board 480i5 interactive whiteboard system and provides information about product parts and accessories.

CHAPTER 1

About your interactive whiteboard system

SMART Board 480i5 interactive whiteboard system features

Your SMART Board 480i5 interactive whiteboard system consists of the SMART Board 480 interactive whiteboard and the SMART UF75 projector system.

When the SMART UF75 projector displays an image from your computer on the touch-sensitive interactive whiteboard, you can do everything that you can do at your computer—open and close applications, scroll through files, hold meetings with others, create new documents or edit existing ones, visit websites, play video clips and more—by touching the surface with your finger or the included pen.

This projector also supports video and audio connections from a variety of devices, including DVD/Blu-ray™ players, VCRs, document cameras and digital cameras, and can project media from these sources onto the interactive screen.

When you use SMART software with your SMART Board 480i5 interactive whiteboard system, you can write or draw over the projected computer image in digital ink, and then save these notes to a .notebook file or directly into any Ink Aware application.

SMART Board 480 interactive whiteboard

Your SMART Board 480 interactive whiteboard is durable and reliable. It features a rugged, hardened interactive surface, a damage-resistant pen and SMART's proprietary DVIT™ (Digital Vision Touch) technology.

Other features of your interactive whiteboard include:

- A pen tray that holds up to two pens
- A durable hard-coated surface optimized for projection and easy to clean

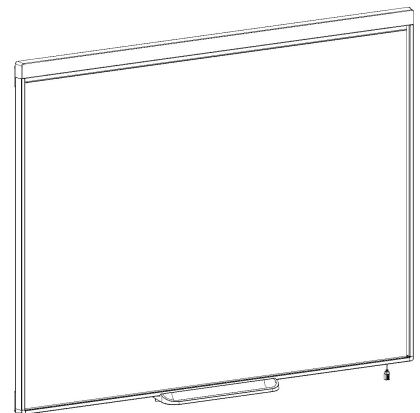
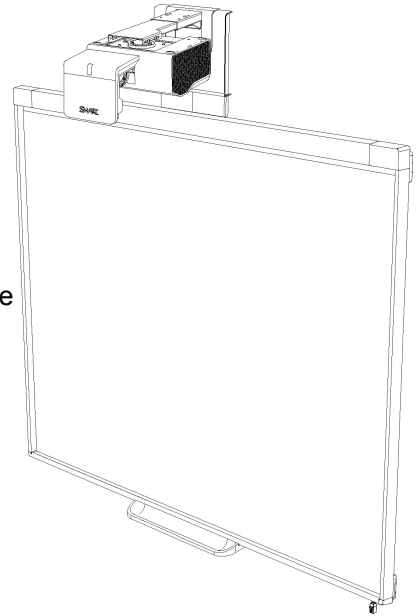

CHAPTER 1

About your interactive whiteboard system

SMART UF75 projector

The SMART UF75 projector system includes a short-throw projector for use with SMART Board 480 interactive whiteboards and a sturdy support system suitable for many different environments.

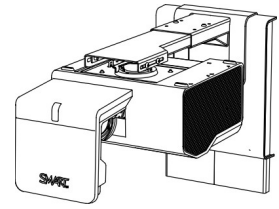

The features of the projector system include:

- Wall-mounted, high-offset projector engine that uses DLP® technology by Texas Instruments™, providing BrilliantColor™ performance and Gamma 2.2 correction with SMART Presentation, Bright Room, Dark Room, sRGB and User modes
- PAL, PAL-N, PAL-M, SECAM, NTSC, NTSC 4.43 video system compatibility
- HDMI™, Composite, S-video, and VESA RGB with additional interface support for Component YPbPr and Component YCbCr inputs with proper adapters (not included)
- WXGA, QVGA, VGA, SVGA, XGA, SXGA, SXGA+ and UXGA video format compatibility
- Native 1024 × 768 resolution (SMART UF75 projector)
- Remote management via a serial RS-232 interface or SNMP
- Alert broadcast feature that enables administrators to send notification messages to network-connected SMART UF75 projector systems for immediate on-screen display
- DLP Link™ technology that ensures compatibility with the emerging 3D content ecosystem
- Protected cable routing through a cable cover that prevents tampering and clutter
- Secure mounting and installation system that includes:
 - Optional projector padlock ring to prevent removal of the projector from the boom
 - Mounting hardware for solid masonry or framed wall installations, as well as a safety tether
 - Templates and instructions for positioning the system safely

Included accessories

The following accessories are included with your SMART Board 480i5 interactive whiteboard system.

Pen

There is one pen included with your interactive whiteboard.

CHAPTER 1

About your interactive whiteboard system

Remote control

The remote control enables you to control the system and set up your SMART UF75 projector. Use the remote control to access menu options, system information and input selection options.

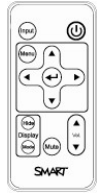

Optional accessories

You can add a variety of optional accessories to best meet your specific needs. Purchase these items from your authorized SMART reseller (smarttech.com/wheretobuy) when you order your interactive whiteboard system or later.

For more information about accessories, go to smarttech.com/accessories.

Chapter 2

Installing your interactive whiteboard system

Choosing a location	6
Choosing a height	6
Routing the cables	7
Installing SMART software	8
Securing the interactive whiteboard system	8
Securing the projector to the boom	8

Consult the included SMART Board 480i5 interactive whiteboard system installation document for instructions on how to install your product and use the mounting template.



IMPORTANT

Use the instructions included with your SMART UF75 projector to install your interactive whiteboard and projector. The instructions in your SMART Board interactive whiteboard box do not include instructions for installing the SMART UF75 projector.

This chapter provides additional considerations and details for installing your interactive whiteboard system.

CHAPTER 2

Installing your interactive whiteboard system

Choosing a location

Choose a location for your SMART Board 480i5 interactive whiteboard system that's far from bright light sources, such as windows or strong overhead lighting. Bright light sources can cause distracting shadows on your interactive whiteboard and can reduce the contrast of the projected image.

Select a wall with a flat, regular surface and sufficient clearance to accommodate your interactive whiteboard system. Install the projector and your interactive whiteboard on the same flat surface. For best presentation alignment, mount your interactive whiteboard system in a location central to your audience's viewing direction. For mobile or adjustable installation options, contact your authorized SMART reseller (smarttech.com/wheretobuy).

WARNING

When mounting the projector boom on a framed or hollow wall, attach both the mounting bracket and the safety tether to a stud to safely support the projector's weight. If you use only drywall anchors, the drywall can fail, resulting in product damage and possible personal injury.

Choosing a height

SMART includes a mounting template with each SMART Board 480i5 interactive whiteboard system. If you lose this template, contact your authorized SMART reseller (smarttech.com/wheretobuy).

Using this template ensures that you:

- Mount the projector at a safe height for head space clearance, while maintaining enough space for airflow and installation access above the unit.
- Position the projector at the correct height above your interactive whiteboard to align the projected image with the touch screen.

Dimensions on the template recommend a distance from the floor suitable for adults of average height. You should consider the general height of your user community when you choose a position for your interactive whiteboard.

CHAPTER 2

Installing your interactive whiteboard system

Routing the cables

When connecting cables from a SMART UF75 projector to your computer, make sure that all cables pass along the top of the interactive whiteboard wall-mounting bracket and then down the side of the interactive whiteboard.

IMPORTANT

If the cables overlap each other behind the interactive whiteboard, they could interfere with the way the interactive whiteboard rests against the wall. Before you mount the interactive whiteboard, it is recommended that you use cable-management straps to appropriately position the cables on the wall.

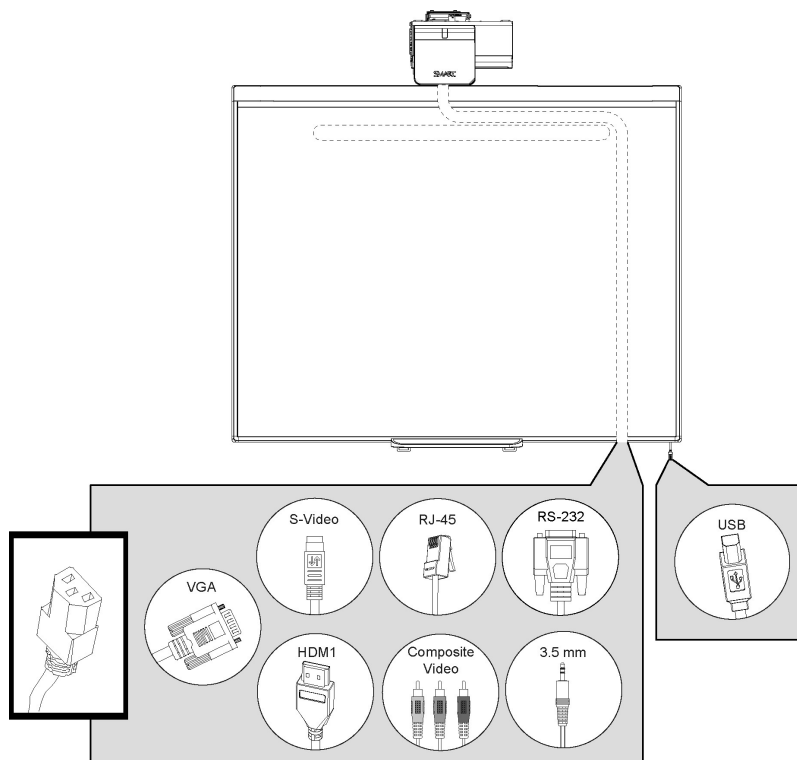

IMPORTANT

Don't connect the power cable to a power outlet until you've connected all the cables to the projector.

CHAPTER 2

Installing your interactive whiteboard system

Installing SMART software

You must install SMART software on the computer connected to your interactive whiteboard system to access all of its features.

Download SMART software from smarttech.com/software. These pages list the minimum hardware requirements for each software version. If SMART software is already installed on your computer, take this opportunity to upgrade your software to ensure compatibility.

CAUTION

Install the version of SMART Product Drivers that shipped with your interactive whiteboard system, or download a newer version if available. If you use an older version of the software, your interactive whiteboard system might not function.

Securing the interactive whiteboard system

This section explains how to secure the different components of your interactive whiteboard system.

Securing the projector to the boom

To learn how to secure the SMART UF75 projector to the boom, see the included *SMART Board 480i5 Interactive Whiteboard System Installation Guide* (smarttech.com/kb/156695).

Chapter 3

Using your interactive whiteboard system

Using your projector.....	9
Using your remote control.....	9
Installing the remote control battery.....	9
Using the remote control buttons.....	11
Adjusting projector settings.....	12
Focusing the image.....	18
Adjusting the image.....	19
SMART UF75 projector connection diagram.....	19
Using your interactive whiteboard.....	21

This chapter describes the basic operation of your interactive whiteboard system, and also explains how to set up your remote control, retrieve system information, access the projector's image adjustment options and integrate your interactive whiteboard system with peripheral devices.

Using your projector

This section explains how to use your projector and its included remote control.

Using your remote control

The SMART UF75 projector remote control enables you to access on-screen projector menus and change projector settings.

Installing the remote control battery

Follow this procedure to use the remote control for the first time or to replace the remote control battery.

WARNING

- Reduce the risk associated with a leaking battery in the projector's remote control by following these practices:
 - Use only the specified type of coin-cell battery.
 - Orient the battery's positive (+) and negative (-) terminals according to the markings on the remote control.
 - Remove the battery when the remote control is unused for an extended period.
 - Do not heat, disassemble, short or recharge the battery, or expose it to fire or high temperatures.
 - Avoid eye and skin contact with the battery if it has a leak.
- Dispose of the exhausted battery and product components in accordance with applicable regulations.

To access or replace the remote control battery

1. Hold down the side release on the left side of the battery holder and pull the battery holder completely out of the remote control.

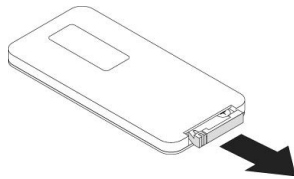

2. If you're accessing the remote control battery for the first time, remove the plastic sheet inside the battery holder, and then place the CR2025 coin cell battery in the battery holder.

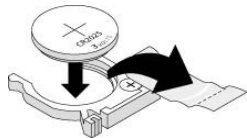

OR

If you're replacing the remote control battery, remove the old battery from the battery holder and replace it with a CR2025 coin cell battery.

IMPORTANT

Align the positive (+) and negative (-) signs on the battery terminals with the correct signs on the battery holder.

3. Insert the battery holder into the remote control.

CHAPTER 3

Using your interactive whiteboard system

Using the remote control buttons

The projector remote control enables you to access on-screen menus and change projector settings.

Use the **Power**  button on the remote control to put the projector into Standby mode or turn it on.

You can also use the **Input** button on the remote control to switch sources on the projector.

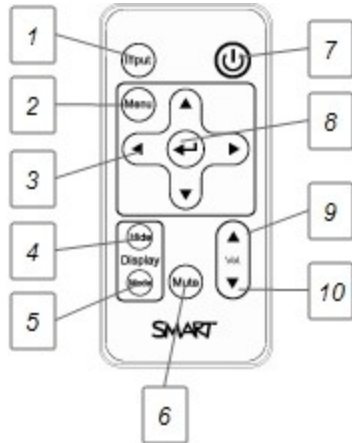

Number	Function	Description
1	Input	Select an input source
2	Menu	Show the projector menus
3	◀ (Left), ▶ (Right), ▲ (Up) and ▼ (Down) arrows	Change the menu selections and adjustments
4	Hide	Freeze, hide or display the image <ul style="list-style-type: none">• Press once to freeze the image. For example, you can display a question on the screen while you check your e-mail.• Press again to hide the image, that is, to display a black screen.• Press again to return to the live image.
5	Mode	Select a display mode
6	Mute	Control mute settings from your audio output device (not included)
7	 (Power)	Put the projector into Standby mode or turn it on
8	↵ (Enter)	Accept the selected mode or option
9	▲ (Volume Up)	Increase the volume
10	▼ (Volume Down)	Decrease the volume

CHAPTER 3

Using your interactive whiteboard system

Adjusting projector settings

The remote control's **Menu** button enables you to access the on-screen display to adjust the projector settings.



IMPORTANT

Keep your remote control in a safe place because you are unable to access projector menu options using any other means.

Setting	Use	Notes
 Image Adjustment menu		
Display Mode	Indicates the projector's display output (SMART Presentation, Bright Room, Dark Room, sRGB and User).	The default is SMART Presentation.
Brightness	Adjusts projector brightness from 0 to 100.	The default is 50.
Contrast	Adjusts the difference between the lightest and darkest parts of the image from 0 to 100.	The default is 50.
Frequency	Adjusts the display data frequency of the projected image from -5 to 5 to match the frequency of your computer's graphics card.	The default is 0. This setting applies to VGA inputs only.
Tracking	Synchronizes your projector's display timing with your computer's graphics card from 0 to 63.	This setting applies to VGA inputs only.
H-position	Moves the projected image's horizontal position left or right from 0 to 100.	Don't adjust this setting unless you're advised to by a certified SMART Support specialist (smarttech.com/contactsupport). You can apply this setting only after you make all boom adjustments. This setting applies to VGA inputs only.
V-position	Moves the projected image's vertical position up or down from -5 to 5.	Don't adjust this setting unless you're advised to by a certified SMART Support specialist (smarttech.com/contactsupport). You can apply this setting only after you make all boom adjustments. This setting applies to VGA inputs only.

CHAPTER 3

Using your interactive whiteboard system

Setting	Use	Notes
Saturation	Adjusts the projected image's color saturation from 0 to 100.	This setting applies to S-video and composite video inputs only.
Sharpness	Adjusts the projected image's sharpness from 0 to 31.	This setting applies to S-video and composite video inputs only.
Tint	Adjusts the image color balance of red and green from 0 to 100.	This setting applies to S-video and composite video inputs only.
White Peaking	Adjusts the image color brightness from 0 to 10 while providing more vibrant white shades.	A value closer to 0 creates a natural image and a value closer to 10 enhances brightness.
Degamma	Adjusts the color performance of the display from 0 to 3.	
Color	Adjusts the Red, Green, Blue, Cyan, Magenta and Yellow colors on the projector from 0 to 100 to provide custom color and luminance output.	Each color has a default value of 100. Adjustments to the color settings register to the User mode.
 Audio menu		
Volume	Increases and decreases the projector's volume from -20 to 20.	The default is 0.
Mute	Mutes the projector's audio output.	If you mute the projector's audio output and then increase or decrease the volume, the volume is restored automatically. You can prevent this from happening by disabling the volume control.
Disable Volume Control	Disables the projector's volume control.	
Closed Captioning	Turns closed captioning on or off.	
Closed Captioning Language	Sets the closed captioning language to CC1 or CC2 .	Typically, CC1 displays American English subtitles, while CC2 displays other regional languages, such as French or Spanish, depending on television channel or media setup.
 Default menu		
3D On/Off	Turns the 3D feature on or off.	The default is off.
3D Format	Displays the current 3D format (Interleaved or Under-over).	Interleaved breaks down the image frame for each eye, alternately displaying a line of visual information from each frame. Under-over concurrently displays horizontally stretched image frames for each eye, one above the other.

CHAPTER 3

Using your interactive whiteboard system

Setting	Use	Notes
3D Invert Left-Right	Selects the 3D Invert setting (L-R or R-L).	L-R displays visual data for the left eye first. R-L displays visual data for the right eye first.
Auto Signal Detect	Enables or disables signal searching of input connectors.	Select On to have the projector continuously switch inputs until it finds an active video source. Select Off to maintain signal detection in one input.
Lamp Reminder	Turns the lamp replacement reminder on or off.	This reminder appears 100 hours before the recommended lamp replacement.
Lamp Mode	Adjusts lamp brightness to Standard or Economy .	Standard displays a high-quality, bright image. Economy increases the lamp life by decreasing the brightness of the image.
Auto Power Off (minutes)	Sets the length of the auto power-off countdown timer between 1 and 240 minutes.	The default is 120 minutes. The timer begins to count down when the projector no longer receives a video signal. The timer finishes when the projector enters Standby mode. Select 0 to turn off the timer.
Zoom	Adjusts the zoom to the center of the image in or out from 0 to 30.	The default is 0. This setting affects image adjustments done mechanically to the boom.
Projector ID	Displays the projector's unique ID number (from 0 to 99) within your organization's network.	

CHAPTER 3

Using your interactive whiteboard system

Setting	Use	Notes
Aspect Ratio	Adjusts the image output to Fill Screen , Match Input or 16:9 .	<p>Fill Screen produces an image that fills the entire screen with stretching and scaling.</p> <p>Match Input matches the projector's aspect ratio to the input's aspect ratio. As a result, black bands might appear along the top and bottom edges of the screen horizontally (letterbox format) or along the left and right edges of the screen vertically (pillarbox format).</p> <p>16:9 changes the output to 16:9 by letterboxing the image, which is recommended for use with HDTV and DVD/Blu-ray discs enhanced for wide-screen television.</p> <p>See <i>Video format compatibility</i> on page 23 for appearance descriptions in each mode.</p>
Startup Screen	Selects the type of startup screen (SMART , Capture User Startup Screen or Preview Startup Screen).	<p>This screen displays when the projector lamp is starting and an image isn't displayed.</p> <p>SMART displays the default SMART logo on a blue background.</p> <p>Capture User Startup Screen closes the on-screen display menu and captures the entire projected interactive whiteboard image. The captured image is displayed the next time that the on-screen display opens. (The capture can take up to one minute, depending on the complexity of the background graphic.)</p> <p>Preview Startup Screen enables you to preview the default or captured startup screen.</p>
Set to Default?	Resets projector settings to their default values.	<p>If you select Yes, all projector settings reset to their defaults, reversing any menu changes you made. This action is irreversible.</p> <p>Don't adjust this setting unless you want to reset all of the applied settings, or unless you're advised to by a certified SMART Support specialist (smarttech.com/contactsupport).</p>
 Network menu		

CHAPTER 3

Using your interactive whiteboard system

Setting	Use	Notes
Network and VGA Out	Activates the VGA out and network features.	
Status	Displays the current network status (Connected , Disconnected or Off).	
DHCP	Displays the status of the network's Dynamic Host Control Protocol (DHCP) as On or Off .	On automatically assigns the DHCP server's IP address to the projector. Off enables an administrator to assign an IP address manually.
Password Reminder	E-mails the network password to the e-mail recipient.	See <i>Web page management</i> on page 50 to set up a destination e-mail address.
IP Address	Displays the projector's IP address in values between 0.0.0.0 and 255.255.255.255.	
Subnet Mask	Displays the projector's subnet work mask number in values between 0.0.0.0 and 255.255.255.255.	
Gateway	Displays the projector's default network gateway in values between 0.0.0.0 and 255.255.255.255.	
DNS	Displays the projector's primary domain name number in values between 0.0.0.0 and 255.255.255.255.	
MAC Address	Displays the projector's MAC address in xx-xx-xx-xx-xx-xx format.	
Group Name	Displays the projector's workgroup name as set by an administrator (maximum 12 characters).	
Projector Name	Displays the projector's name as set by an administrator (maximum 12 characters).	
Location	Displays the projector's location as set by an administrator (maximum 16 characters).	
Contact	Displays the contact name or number for projector support as set by an administrator (maximum 16 characters).	
 Language menu		

CHAPTER 3

Using your interactive whiteboard system

Setting	Use	Notes
Language	Selects language preference.	Projector menu support is available in English (default), Brazilian Portuguese, Czech, Danish, Dutch, Finnish, French, German, Greek, Iberian Portuguese, Italian, Korean, Japanese, Norwegian, Polish, Russian, Simplified Chinese, Spanish, Swedish and Traditional Chinese.
 Information menu		
Lamp Hours	Displays the current number of lamp usage hours from 0 to 4000 hours from when it was last reset.	Always reset Lamp Hours after you replace a lamp because lamp service reminders are based on the current hours of use. See <i>Resetting the lamp timer</i> on page 33 for details on the lamp hour reset procedure.
Input	Displays the current input source (VGA1, VGA2, Composite, S-Video, HDMI or None).	
Resolution	Displays the projector's current display resolution.	
Firmware Version	Displays the projector's firmware version in x.x.x.x format.	
MPU Version	Displays the projector microprocessor's firmware version in x.x.x.x format.	
Network Version	Displays the projector's network card firmware version in x.x.x.x format.	
Model Number	Displays the projector's model number.	
Serial Number	Displays the projector's serial number.	

CHAPTER 3

Using your interactive whiteboard system

Focusing the image

To focus the projected image, use the focus lever located on the projector lens.

■ To focus and adjust the image

Move the focus lever up or down until the image is in focus.

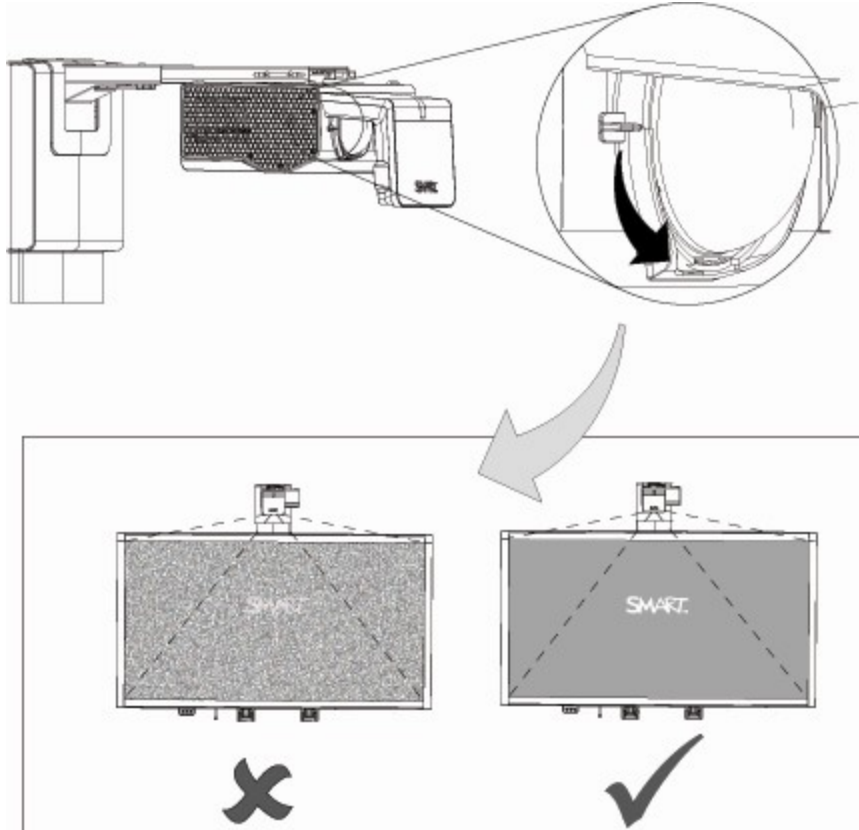

CHAPTER 3

Using your interactive whiteboard system

Adjusting the image

Refer to these notes when adjusting the projected image as described in the included *SMART Board 480i5 Interactive Whiteboard Systems Installation Guide* (smarttech.com/kb/156695).

- Project a computer image set to the proper resolution while adjusting the image. If you don't have a computer, use the projector's default background so that you can see the full projected image clearly. If possible, use a pure white screen to allow for easier alignment.
- Use the mechanical adjustments described in the installation document to make image adjustments instead of the projector's on-screen menu options.
- As you tilt the projector up or lower its mounting boom to raise the image, the entire projected image increases or decreases in size, especially at the bottom of the projected image.
- When adjusting keystone (tilt), ensure that the top and bottom edges of the image are horizontal before you position the left and right edges of the image relative to your interactive whiteboard.
- When you move the projector forward or backward on the boom to make the image larger or smaller, you might need to tilt or turn the projector slightly to keep the image square. Loosen the lever slightly to aid in this adjustment.
- To fine-tune the image, you may need to repeat all steps described in the installation document in smaller increments.
- Make sure that the projected image doesn't project on to the inside edge of the interactive whiteboard frame. A small gap between the outer edge of the projected image, and the inner edge of the interactive whiteboard frame will provide optimal system performance.

SMART UF75 projector connection diagram

You can connect a variety of peripheral devices to your projector, including DVD/Blu-ray players, VCRs, document cameras, digital cameras and high-definition sources, as well as peripheral device outputs, such as a secondary projector or a flat-panel display and powered speakers.

i NOTE

You might need to purchase third-party adapters to connect certain peripheral devices.

CHAPTER 3

Using your interactive whiteboard system

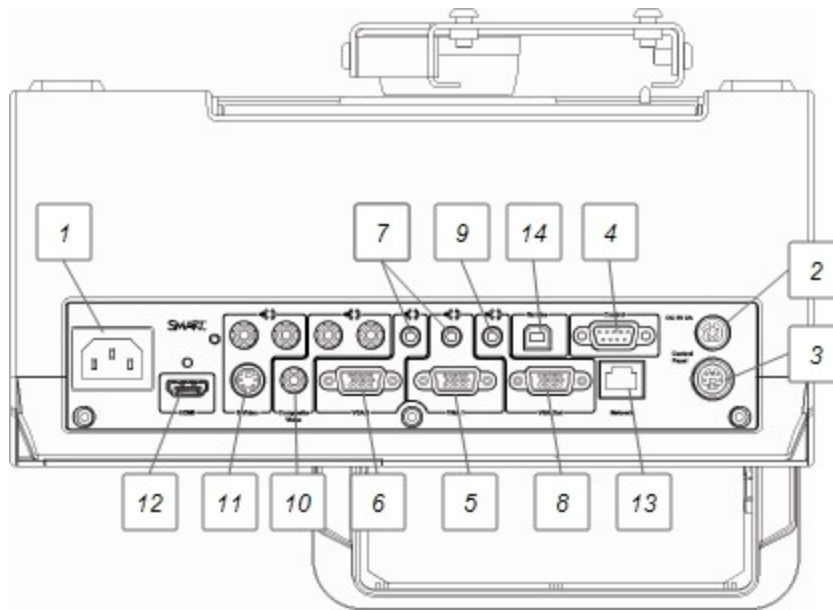

No.	Connector	Connect to:
1	Power	Power supply
2	4-pin power mini-DIN 5V/2A output	[Not used]
3	7-pin mini-DIN	[Not used]
4	DB9 RS-232F	Room control
5	DB15F RGB video input (VGA 1)	Primary computer (not included)
6	DB15F RGB video input (VGA 2)	Secondary computer (not included)
7	3.5 mm phone jack audio input (×2)	Y cable
8	DB15F RGB video output (VGA Out)	Secondary display (not included)
9	3.5 mm phone jack audio output	Speakers (not included)
10	RCA composite video input (and left and right RCA audio input)	Video source (not included) through RCA connector pod
11	4-pin mini-DIN S-video input (and left and right RCA audio input)	Video source (not included)
12	HDMI input	High definition video source (not included)
13	RJ45	Network (for web page management and SNMP access)
14	USB B	Computer (for service access only)

CHAPTER 3

Using your interactive whiteboard system

i NOTES

- To connect your SMART Board 480 interactive whiteboard, see the *SMART Board 480i5 Interactive Whiteboard System Installation Guide* (smarttech.com/kb/156695).
- To connect accessories to your SMART Board interactive whiteboard, refer to the documents included with the accessories and consult the SMART Support website (smarttech.com/support) for additional information.

Using your interactive whiteboard

Refer to the *SMART Board 480 Interactive Whiteboard User's Guide* (smarttech.com/kb/156693) for more information on using your interactive whiteboard.

When you connect your SMART Board interactive whiteboard system to a computer with SMART software, you can access the full capabilities of your interactive whiteboard.

For more resources, go to smarttech.com, click the flag icon to the right of the SMART logo, and then select your country and language. In the Support section of this website, you'll find up-to-date, product-specific information, including setup instructions and specifications. The SMART Learning Space (learningspace.smarttech.com) also has free learning resources, hands-on lessons and information on how to get more training.

Chapter 4

Integrating other devices

Video format compatibility.....	23
Native video format	23
Video format compatibility.....	23
SMART UF75 projector.....	24
HD and SD signal format compatibility.....	24
SMART UF75 projector.....	25
Video system signal compatibility.....	25
SMART UF75 projector.....	25
Connecting peripheral sources and outputs.....	25

This chapter provides information on integrating your SMART Board 480i5 interactive whiteboard system with peripheral devices.

Video format compatibility

SMART UF75 projectors have a native video format and various video format compatibility modes. You can change image appearances for certain formats and compatibilities.

Native video format

The following table lists the native VESA RGB video formats for the projector.

Projector	Resolution	Mode	Aspect ratio	Refresh rate (Hz)	Horizontal frequency (kHz)	Pixel clock (MHz)
SMART UF75	1024 × 768	XGA	4:3	60	48	63.5

Video format compatibility

The following tables list the projectors' compatible VESA RGB video formats by resolution, which the project adjusts automatically when you use the aspect ratio commands described in *Default menu* on page 13.

CHAPTER 4

Integrating other devices

SMART UF75 projector

Resolution	Mode	Aspect ratio	Refresh rate (Hz)	“Match Input” appearance
720 × 400	720×400_85	1.8:1	85.039	Letterbox
640 × 480	VGA 60	4:3	59.94	Full screen
640 × 480	VGA 72	4:3	72.809	Full screen
640 × 480	VGA 75	4:3	75	Full screen
640 × 480	VGA 85	4:3	85.008	Full screen
800 × 600	SVGA 56	4:3	56.25	Full screen
800 × 600	SVGA 60	4:3	60.317	Full screen
800 × 600	SVGA 72	4:3	72.188	Full screen
800 × 600	SVGA 75	4:3	75	Full screen
800 × 600	SVGA 85	4:3	85.061	Full screen
832 × 624	MAC 16"	4:3	74.55	Full screen
1024 × 768	XGA 60	4:3	60.004	Full screen
1024 × 768	XGA 70	4:3	70.069	Full screen
1024 × 768	XGA 75	4:3	75.029	Full screen
1024 × 768	XGA 85	4:3	84.997	Full screen
1024 × 768	MAC 19"	4:3	74.7	Full screen
1152 × 864	SXGA1 75	4:3	75	Full screen
1280 × 768	SXGA1 75	1.67:1	60	Letterbox
1280 × 800	WXGA	16:10	60	Letterbox
1280 × 800	WXGA	16:10	58.2	Letterbox
1280 × 960	Quad VGA 60	4:3	60	Full screen
1280 × 960	Quad VGA 85	4:3	85.002	Full screen
1280 × 1024	SXGA3 60	5:4	60.02	Letterbox
1280 × 1024	SXGA3 75	5:4	75.025	Letterbox
1280 × 1024	SXGA3 85	5:4	85.024	Letterbox
1400 × 1050	SXGA+	4:3	59.978	Full screen
1600 × 1200	UXGA	4:3	60	Full screen

HD and SD signal format compatibility

The following tables list the projectors' high definition and standard definition format signal compatibility, which the projector adjusts automatically when you use the aspect ratio commands described in *Default menu* on page 13.

CHAPTER 4

Integrating other devices

SMART UF75 projector

Signal format	Aspect ratio	Horizontal frequency (kHz)	Vertical frequency (Hz)	“Match Input” appearance
480i (DVD player) (640 × 480)	4:3	15.73	59.94	Full screen
567i (DVD player) (720 × 576)	5:4	15.63	50	Letterbox
720p	16:9	44.96	59.94	Letterbox
720p	16:9	35	50	Letterbox
1080i	16:9	33.7	59.94	Letterbox
1080i	16:9	28.1	50	Letterbox

Video system signal compatibility

The following tables list the projectors' video system signal compatibility, particularly for signals delivered over S-Video and Composite video connectors, which the projector adjusts automatically when you use the aspect ratio commands described in *Default menu* on page 13.

i NOTE

The **16:9** command delivers all video modes with black bands along the top and bottom edges of the screen. The **Match Input** command might deliver video modes with blank bands along the top and bottom edges of the screen, depending on the input resolution.

SMART UF75 projector

Video mode	Aspect ratio	Horizontal frequency (kHz)	Vertical frequency (Hz)	Color signal (MHz)
NTSC	4:3	15.73	29.96	3.58
PAL	4:3	15.62	25	4.43
SECAM	4:3	15.62	25	4.25 (f_{ob}) 4.06 (f_{or})
PAL-M	4:3	15.73	59.94	3.58
PAL-N	4:3	15.63	50	3.58
PAL-60	4:3	15.73	59.94	4.43
NTSC 4.43	4:3	15.73	59.94	4.43

Connecting peripheral sources and outputs

Follow these instructions if you have a peripheral device to connect to your interactive whiteboard system for a short time, such as a DVD/Blu-ray player.

CHAPTER 4

Integrating other devices

NOTE

Measure the distance between the projector and the peripheral device you want to connect. Make sure each cable is long enough, has plenty of slack and can be placed safely in your room without presenting a trip hazard.

To connect a peripheral source or output to your projector

1. Connect your peripheral device's input cables to the projector.
2. Switch input sources to the peripheral device by pressing the **Input** button on the remote control.

Chapter 5

Maintaining your interactive whiteboard system

Maintaining your interactive whiteboard.....	27
Cleaning the projector.....	27
Focusing and adjusting the projector image.....	28
Replacing the projector lamp.....	29
Removing and replacing the projector lamp module.....	29
Resetting the lamp timer.....	33

This chapter includes methods for properly cleaning and preventing damage to your SMART Board 480i5 interactive whiteboard system.

Maintaining your interactive whiteboard

For information on maintaining your interactive whiteboard, see the *SMART Board 480 Interactive Whiteboard User's Guide* (smarttech.com/kb/156693).

Cleaning the projector

WARNING

Cleaning a wall-mounted projector can result in a fall or injury. Use caution when climbing a ladder, and consider removing the projector from its wall-mounting bracket to clean it.

CAUTION

- Never touch the mirror with your hands or a brush, and do not scrub the surface of the mirror with the supplied cleaning cloth. Instead, use the supplied cleaning cloth to clean the mirror with a light touch, and do not put any cleaning solvents on the cloth or the mirror.

CHAPTER 5

Maintaining your interactive whiteboard system

- Before you clean the projector, press the **Power**  button twice on the remote control to put the system in Standby mode, and then allow the lamp to cool for at least 30 minutes.
- Do not spray cleaners, solvents or compressed air directly on the projector. Do not use spray cleaners or solvents near any part of the projector because they can damage or stain the unit. Spraying the system could spread a chemical mist on some of the projector's components and lamp, resulting in damage and poor image quality.
- Do not allow liquids or commercial solvents of any kind to flow into the projector base or head.



IMPORTANT

- When cleaning the interactive whiteboard system:
 - Wipe the exterior of the projector with a lint-free cloth.
 - If necessary, use a soft cloth moistened with a mild detergent to clean the projector housing.
- Do not use abrasive cleaners, waxes or solvents.

When cleaning the projector's mirror:

- Use a bellows bulb or air blower bulb (commonly found in audio-visual supply stores) to blow off dust. Never touch the mirror with your bare hands or a brush.
- If wiping the mirror is unavoidable, wear protective gloves and gather the cleaning cloth into a ball. Gently run the cleaning cloth across the mirror like you would a feather duster.

When cleaning the projector's lens:

- Use a bellows bulb or air blower bulb (commonly found in audio-visual supply stores) to blow off dust. Never touch the lens with your bare hands or a brush.
- If wiping the lens is unavoidable, wear protective gloves and gather the cleaning cloth into a ball. Gently run the cleaning cloth across the lens from the center to the edge, using the cleaning cloth like you would a feather duster.

Focusing and adjusting the projector image

For information on focusing and adjusting the projector image, see *Focusing the image* on page 18 and *Adjusting the image* on page 19.

Replacing the projector lamp

This section provides detailed instructions for replacing the projector lamp.

Removing and replacing the projector lamp module

Eventually the lamp module will dim, and a message will appear reminding you to replace the lamp. Make sure you have a replacement projector lamp before proceeding with the following instructions.



WARNING

- Replace the lamp when the projector displays its lamp life warning message. If you continue to use the projector after this message appears, the lamp can shatter or burst, scattering glass throughout the projector.
- If the lamp shatters or bursts, leave and then ventilate the area.

Next do the following:

- Do not touch the glass fragments because they can cause injury.
 - Wash your hands thoroughly if you have come into contact with lamp debris.
 - Thoroughly clean the area around the projector, and discard any edible items placed in that area because they could be contaminated.
 - Call your authorized SMART reseller (smarttech.com/wheretobuy) for instructions. Do not attempt to replace the lamp.
- Replacing the lamp in a wall-mounted projector can result in a fall or injury. Use caution when climbing a ladder, and consider removing the projector from the wall-mounting bracket to replace the lamp.
 - Uncovering the lamp while the projector is mounted on the wall-mounting bracket can lead to product damage or personal injury from falling pieces of glass if the lamp is broken.

CHAPTER 5

Maintaining your interactive whiteboard system

- When replacing the projector lamp:
 - Put the projector into Standby mode and wait 30 minutes for the lamp to cool completely.
 - Do not remove any screws other than those specified in the lamp replacement instructions.
 - Wear protective eyewear while changing the lamp. Failure to do so can cause injuries including loss of eyesight if the lamp shatters or bursts.
 - Use only replacement lamps approved by SMART Technologies. Contact your authorized SMART reseller (smarttech.com/wheretobuy) for replacement parts.
 - Never replace the lamp assembly with a previously used lamp assembly.
 - Always handle the fragile lamp assembly with care to prevent premature lamp failure or exposure to mercury. Use gloves when touching the lamp. Do not touch the lamp with your fingers.
 - Recycle or dispose of the lamp as hazardous waste in accordance with local regulations.

You need a Phillips® No. 2 screwdriver and a flat screwdriver to complete these procedures.

To remove the old lamp

1. Press the **Power**  button twice on the remote control to put the projector into Standby mode.
2. Wait at least 30 minutes for the projector to cool down.
3. Disconnect the power cable from the projector.

CHAPTER 5

Maintaining your interactive whiteboard system

4. Remove the lamp cover from the projector, and then put it in a safe place.

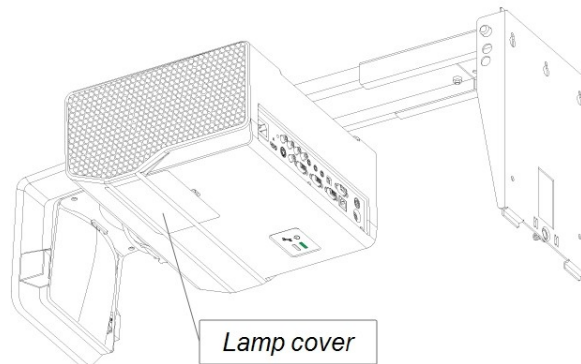

TIP

If the cover is difficult to remove, insert a flat screwdriver or small coin into the slot on the bottom of the lamp cover to gently pry the cover open.

5. Use a Phillips screwdriver to loosen the two captive screws from the bottom of the lamp module.

NOTE

Don't try to remove these screws. Captive screws can't be removed, but they must be loose.

6. Use the handle on the bottom of the lamp module to slide out the lamp and remove it from the projector.

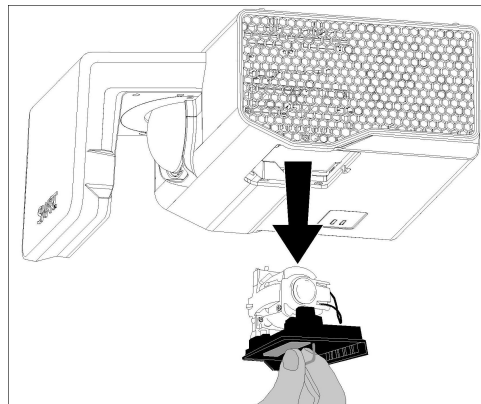

CHAPTER 5

Maintaining your interactive whiteboard system

■ To put the new lamp module into the projector

1. Remove the new lamp module from its packaging.
2. Carefully place the lamp module into the projector using the handle on the top of the module. Hold the lamp module vertically and guide it into its slot. Gently press the power end of the lamp module against the projector to ensure the power plug makes contact with the projector's power receptacle.

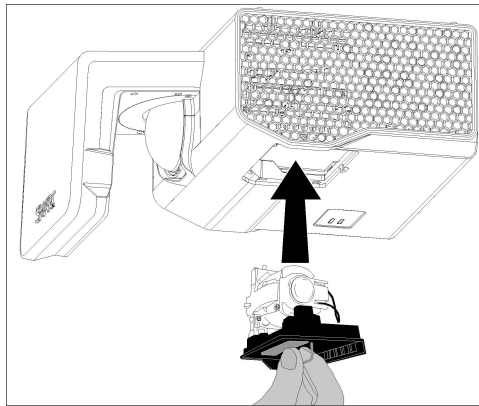

i NOTE

You should be able to place the lamp module into the projector easily without applying much force.

3. Use the Phillips screwdriver to tighten the captive screws.
4. Carefully replace the lamp cover.
5. Connect the power cable to the wall outlet.
6. Press the **Power**  button once on the remote control to confirm that the projector is operating and that the lamp module is correctly installed
7. Put the old lamp in a secure container, and handle it gently until you recycle it.

■ To finish the projector lamp installation

1. Turn on the projector.
2. Adjust the projector image if necessary (see *Adjusting the image* on page 19).
3. Access the service menu to reset the lamp hour counter (see *Resetting the lamp timer* on next page).
4. Activate the projector's alert e-mails and lamp warnings if they've been deactivated (see *E-mail alerts* on page 53 and *Control panel* on page 50).

Resetting the lamp timer

After you replace the lamp, you need to access the projector service menu and reset the lamp hour counter. To prevent accidental errors, only a system administrator should perform this procedure.

i NOTE

Always reset the Lamp Hours after you replace the lamp because lamp service reminders are based on the current hours of use.

To reset the lamp timer

1. Using the remote control, press the following buttons quickly to access the service menu:
Down, Up, Up, Left, Up.

▲ CAUTION

Do not adjust any settings in the service menu other than those listed in this guide. Changing other settings can damage or affect the operation of your projector and invalidates your warranty.

2. Scroll down to the *Lamp Hour Reset* field, and then press **OK**.

Both Lamp Hour values (Standard and Economy) are reset to zero.

▲ CAUTION

Do not use the Lamp Hour Reset feature unless you have just replaced the lamp. Resetting the lamp hour counter on an old lamp can damage your projector due to lamp failure.

i NOTE

You're unable to reset the Display Hour value because it's the running total of hours the projector has been in use.

3. The *SMART UF75 Settings* menu appears.
4. Select  to confirm that Lamp Hours is reset to zero.

Chapter 6

Troubleshooting your interactive whiteboard system

Correcting image alignment issues.....	36
Diagnosing issues using the interactive whiteboard system indicators and controls.....	36
Interactive whiteboard indicators and controls.....	36
Projector lights and status.....	36
Projector error states.....	37
Your projector doesn't respond to commands.....	37
The "Projector Overheated" message appears.....	38
The "Fan Failure" message appears.....	38
The "Color Wheel Failure" message appears.....	39
The "Lamp Failure" message appears.....	39
The projector Power light isn't lit.....	39
Resolving network communication issues.....	40
Resolving audio issues.....	41
Resolving video issues.....	41
Resolving image issues.....	42
Loss of signal.....	42
No projected image.....	42
Partial, scrolling or incorrectly displayed image.....	43
Unstable or flickering image.....	43
Your image has a vertical flickering bar.....	44
Unaligned projected image.....	44
Accessing the service menu.....	45
Retrieving your password.....	46
Resetting the projector.....	46
Locating serial numbers.....	46
Transporting your interactive whiteboard system.....	47

This chapter provides basic troubleshooting information for your interactive whiteboard system.

For issues not covered in this chapter, contact your authorized SMART reseller (smarttech.com/wheretobuy) or consult the SMART Support website (smarttech.com/support).

Correcting image alignment issues

Alignment errors occur when the projected image isn't perpendicular to the screen. Alignment errors can occur when you mount your interactive whiteboard system on an uneven surface or a wall that has obstructions, or if you swivel the projector too far from the vertical center of your interactive whiteboard.

Use the instructions in the included *SMART Board 480i5 Interactive Whiteboard Systems Installation Guide* (smarttech.com/kb/156695) to eliminate most image alignment issues.

Diagnosing issues using the interactive whiteboard system indicators and controls

This section documents the indicators and controls of the interactive whiteboard system components.

Interactive whiteboard indicators and controls

For more information to resolve common issues, see the *SMART Board 480 Interactive Whiteboard User's Guide* (smarttech.com/kb/156693).

Projector lights and status

Two indicator lights (Power and Service) are located on the bottom of the SMART UF75 projector. Specific light sequences convey information about the state of the projector, including errors.

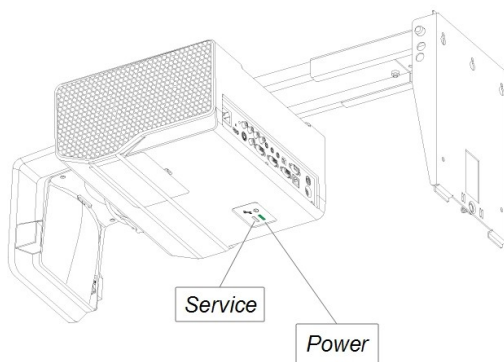



IMPORTANT

After you resolve the projector's issue, disconnect and then connect the projector power cable to clear the indicator light sequence, and then reset the projector's status (see *Resetting the projector*

CHAPTER 6

Troubleshooting your interactive whiteboard system

on page 46).

Power light	Service light	Message
Solid amber	Off	The projector is off but still receiving power (Standby mode). Press the Power  button on the remote control to turn it on.
Flashing green	Off	The projector is in the powering (startup) power state. Wait for the projector to finish turning on.
Solid green	Off	The projector is in the operating (on) power state. Press the Power  button on the remote control twice to turn it off.
Flashing amber	Off	The projector is in the cooling power state. Wait for it to finish cooling.
Off	Flashing red	The projector is overheating. It could shut down automatically. <i>See The “Projector Overheated” message appears on next page to troubleshoot the projector.</i>
Off	Solid red	The projector has a fan issue. It could shut down automatically. <i>See The “Fan Failure” message appears on next page to troubleshoot the projector.</i>
Off	Solid red	The projector has a color wheel issue. <i>See The “Color Wheel Failure” message appears on page 39 to troubleshoot the projector.</i>
Solid amber	Flashing red	The projector has a lamp issue. <i>See The “Lamp Failure” message appears on page 39 to troubleshoot the projector.</i>
Off	Off	The projector isn't receiving power. <i>See The projector Power light isn't lit on page 39 to troubleshoot the projector.</i>

Projector error states

System administrators can solve or troubleshoot the following projector error states on their own prior to contacting SMART Support. Performing an initial troubleshooting on your projector will reduce the time of a support call.

Your projector doesn't respond to commands

If your projector doesn't respond to commands or if it starts to display code after you enter a command, perform the following procedure.

CHAPTER 6

Troubleshooting your interactive whiteboard system

■ To restart an unresponsive projector

1. Put the projector into Standby mode, and then wait 15 minutes for it to cool down.
2. Disconnect the power cable from the power outlet, and then wait at least 60 seconds.
3. Connect the power cable, and then turn on the projector.

The “Projector Overheated” message appears

If the “Projector Overheated” message appears and the projector enters Standby mode during use, one of the following issues is occurring:

- The projector is overheating internally because of blocked air vents or an internal temperature over 131°F (55°C).
- The temperature outside the projector is too high.

■ To resolve the “Projector Overheated” error

1. Put the projector into Standby mode, and then wait 15 minutes for it to cool down.
2. If your room is hot, lower the temperature if possible.
3. Ensure that nothing is blocking the projector’s air intake and exhaust.
4. Disconnect the power cable from the power outlet, and then wait at least 60 seconds.
5. Connect the power cable, and then turn on the projector.
6. If the previous steps don’t resolve the issue, disconnect the power cable, and then contact your authorized SMART reseller (smarttech.com/wheretobuy).

The “Fan Failure” message appears

If the “Fan Failure” message appears and the projector enters Standby mode during use, one or both of the following issues is occurring:

- The projector is overheating internally.
- One of the fans has failed.

■ To resolve the “Fan Failure” error

1. Follow steps 1 to 5 of *To resolve the “Projector Overheated” error* above.
2. If the lamp doesn’t illuminate, put the projector into Standby mode and wait 15 minutes for it to cool down.
3. Disconnect the power cable, and then contact your authorized SMART reseller (smarttech.com/wheretobuy).

CHAPTER 6

Troubleshooting your interactive whiteboard system

The “Color Wheel Failure” message appears

If the “Color Wheel Failure” message appears and the projector enters Standby mode during use, the projector has a color wheel issue.

■ To resolve the “Color Wheel Failure” error

1. Put the projector into Standby mode, and then wait 15 minutes for it to cool down.
2. Disconnect the power cable from the power outlet, and then wait at least 60 seconds.
3. Connect the power cable, and then turn on the projector.
4. If the previous steps don't resolve the issue, disconnect the power cable, and then contact your authorized SMART reseller (smarttech.com/wheretobuy).

The “Lamp Failure” message appears

If the “Lamp Failure” message appears and the lamp turns off during use or doesn't turn on, one of the following issues is occurring:

- The lamp is overheating, likely due to blocked air vents.
- The lamp has reached the end of its life.
- The projector has an internal problem.

■ To resolve the “Lamp Failure” error

1. Follow steps 1 to 5 of *To resolve the “Projector Overheated” error* on previous page.
2. If the lamp doesn't illuminate, put the projector into Standby mode and wait 15 minutes for it to cool down.
3. Disconnect the power cable.
4. Replace your lamp as described in *Removing and replacing the projector lamp module* on page 29.
5. If the projector still doesn't turn on or if it continues to display the lamp error message, disconnect the power cable, and then contact your authorized SMART reseller (smarttech.com/wheretobuy).

The projector Power light isn't lit

If the projector Power light isn't lit, one of the following issues is occurring:

- There was a power outage or a power surge.
- A circuit breaker or a safety switch was tripped.

CHAPTER 6

Troubleshooting your interactive whiteboard system

- The projector isn't connected to the power source.
- The projector has an internal problem.

■ To resolve the unlit projector Power light issue

1. Check the power source, and then make sure that all cables are connected.
2. Confirm that the projector is connected to an active power outlet.
3. Make sure the pins on the connectors aren't broken or bent.
4. Make sure the Hide Display feature on the remote is disabled. See *Using the remote control buttons* on page 11.
5. If the previous steps don't resolve the issue, disconnect the power cable and then contact your authorized SMART reseller (smarttech.com/wheretobuy).

Resolving network communication issues

If you don't have network access, perform the following procedure to troubleshoot your system.

■ To resolve network communication issues

1. Ensure that your network's RJ45 cable is properly connected to the modular cable connection on the projector's connection panel.
2. Ensure that the LAN warning light on the projector is green. To activate the LAN, use the "vgaoutnetenable=on" RS-232 command (see *Projector programming commands* on page 56) or the "Network and VGA out" projector menu option (see *Network menu* on page 15). The network function on the projector doesn't work until you send one of these commands.
3. Press the **Menu** button, and then select the **Network Settings** menu to check the IP address. See *Network menu* on page 15 for a description of the IP address field. Enter this IP address into your browser or SNMP agent.
4. If you still don't have network access, contact your network administrator. If your administrator is unable to resolve the issue, contact your authorized SMART reseller (smarttech.com/wheretobuy).

Resolving audio issues

The projector doesn't have integrated speakers, but you can connect an audio system to the audio output connector in the projector's connection panel. If no sound is coming from your audio system, perform the following procedure.

■ To resolve audio issues

1. Ensure that the speakers' or audio system's cables are properly connected to the audio output plug on the projector's connection panel.
2. Press the **Mute** button on the projector's remote control, and if Audio Mute is on, turn it off.
3. Use the projector's remote control to ensure that volume isn't at the lowest setting.
4. Ensure that your speaker or audio system is on and that volume is enabled.
5. Check that your source input, such as your computer or video device, isn't malfunctioning, that its audio output is on and that its volume isn't set to the lowest position.
6. If the previous steps don't resolve the issue, contact your authorized SMART reseller (smarttech.com/wheretobuy).

Resolving video issues

If your projector has a frozen image, perform the following procedure.

■ To resolve a frozen image

1. Ensure that the Hide Display feature is off. Press the **Hide** button on the projector's remote control to hide or show the display.
2. Ensure that your source device, such as your DVD player or computer, isn't malfunctioning.
3. Put the projector into Standby mode, and then wait 15 minutes for it to cool down.
4. Disconnect the power cable from the power outlet, and then wait at least 60 seconds.
5. Connect the power cable, and then turn on the projector.
6. If the previous steps don't resolve the issue, contact your authorized SMART reseller (smarttech.com/wheretobuy).

Resolving image issues

Computers, peripherals, source inputs and their connection cables might not be correctly set up to transmit their signals to your SMART Board interactive whiteboard system. Refer to *Video format compatibility* on page 23 and the following section to help resolve these issues.

Loss of signal

If a visual source signal is lost or if the signal is being switched to a different device or input, the projector doesn't show a source signal and instead displays the SMART logo on a blue screen.

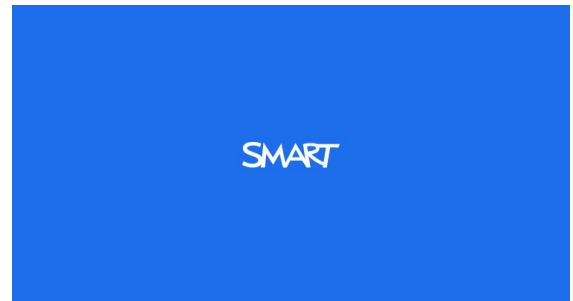

■ To resolve signal loss issues

1. Wait approximately 45 seconds for the image to synchronize. Some video signals require a longer synchronization period.
2. If the image doesn't synchronize, check your cable connections to the projector.
3. Ensure that the image signal is compatible with the projector (see *Video format compatibility* on page 23).
4. If your projector still doesn't show a source signal, contact your authorized SMART reseller (smarttech.com/wheretobuy).

No projected image

If the projector displays no image at all, and the interactive whiteboard and projector power lights aren't on, perform the following procedure.

■ To resolve projected image issues

1. Ensure that the power cable is connected to the power outlet.
2. Ensure that your cables are correctly and securely connected as described in the included *SMART Board 480i5 Interactive Whiteboard Systems Installation Guide* (smarttech.com/kb/156695).
3. Check the power cable and VGA connector pins to make sure they aren't bent or broken.

4. Ensure that the projector lamp is installed securely.
5. Confirm that your projector is turned on and that the projector status lights are illuminated. If the status lights display unusual behavior, see *Projector lights and status* on page 36 to troubleshoot your system.

Partial, scrolling or incorrectly displayed image

i NOTES

- The following procedure applies to Windows® 95, Windows 98, Windows 2000 and Windows XP operating systems on desktop computers only.
- This procedure may vary depending on your version of Windows operating system and your system preferences.

■ To resolve a partial, scrolling or incorrectly displayed image

1. Select **Start > Control Panel**.
2. Double-click **Display**.
The *Display Properties* window appears.
3. Click **Settings**.
4. Verify that your display resolution setting is equal to 1024 × 768.
5. If the projector still does not display the entire image, perform the following procedure to change the monitor display.

■ To change the monitor display

1. Click **Advanced Properties**.
2. On the *Monitor* tab, click **Change**.
3. Click **Show all devices**, and then select **Standard monitor types** from the list.
4. In the *Models* list, select the resolution you need.
5. Verify that the resolution setting of the monitor display is equal to 1024 × 768.

Unstable or flickering image

If the projector's image is unstable or flickering, you could have different tracking settings on your input source.

 **IMPORTANT**

Write down your setting values before adjusting any of the settings in the following procedure.

 **To resolve your unstable or flickering image**

1. Adjust the **Tracking** setting in the on-screen display. See *Image Adjustment menu* on page 12.
2. Optionally, reset the projector as described in *Resetting the projector* on page 46 to adjust the tracking to its original value.

 **IMPORTANT**

This action resets all values to their defaults.

Your image has a vertical flickering bar

If the projector displays a vertical flickering bar, you could have different frequency settings on your input source.

 **IMPORTANT**

Write down your setting values before adjusting any of the settings in the following procedure.

 **To resolve the vertical flickering bar issue**

1. Adjust the **Frequency** setting in the on-screen display. See *Image Adjustment menu* on page 12.
2. Check the display mode of your computer's graphics card. Make sure it matches one of the projector's compatible signal formats (see *Video format compatibility* on page 23). Refer to your computer's manual for more information.
3. Configure the display mode of your computer's graphics card to make it compatible with the projector. Refer to your computer's manual for more information.
4. Optionally, reset the projector as described in *Resetting the projector* on page 46 to adjust your frequency to its original value.

 **IMPORTANT**

This action resets all values to their defaults.

Unaligned projected image

The SMART UF75 projector image can slip if the projector is moved often or installed in a location prone to vibration, such as next to a heavy door. Follow these precautions to help prevent the image

CHAPTER 6

Troubleshooting your interactive whiteboard system

from becoming misaligned:

- Make sure that the installation wall is plumb and square and doesn't move or vibrate excessively.
- Make sure that there are no obstructions behind the projector's wall mount bracket, and that the bracket is firmly secured to the wall according to the installation instructions.
- Adjust the projected image. See the included *SMART Board 480i5 Interactive Whiteboard Systems Installation Guide* (smarttech.com/kb/156695) and *Adjusting the image* on page 19.

Accessing the service menu

CAUTION

- To prevent tampering or unintentional changes, only system administrators should access the service menu. Do not share the service menu access code with casual users of your interactive whiteboard system.
- Do not adjust any settings in the service menu other than those listed in this guide. Changing other settings can damage or affect the operation of your projector and invalidates your warranty.

Retrieving your password

If you forget the projector's password, you can retrieve it by accessing the projector service menu directly from the projector or from the password settings menu on your projector's web page (see *Password settings* on page 53).

■ To retrieve your password from the service menu

1. Using the remote control, press the following buttons quickly to access the service menu:
Down, Up, Up, Left, Up.
2. Scroll to the *Password Get* field, and then press **Enter** on the remote control.
The password appears on the screen.
3. Record the password.
4. Scroll to the *Exit* field, and then press **Enter** on the remote control to exit the projector service menu.

Resetting the projector

At some point during troubleshooting, you might need to reset all projector settings.



IMPORTANT

This action is irreversible.

■ To reset all projector settings

1. Using the remote control, press the following buttons quickly to access the service menu:
Down, Up, Up, Left, Up.
2. Scroll to the *Factory Reset* field, and then press **Enter** on the remote control.
3. Scroll to the *Exit* field, and then press **Enter** on the remote control to exit the projector service menu.

Locating serial numbers

Before contacting SMART Support (see *Customer support* on page 71), make note of your interactive whiteboard and projector serial numbers.

For the location of the SMART Board 480 interactive whiteboard serial number, see the *SMART Board 480 Interactive Whiteboard User's Guide* (smarttech.com/kb/156693).

CHAPTER 6

Troubleshooting your interactive whiteboard system

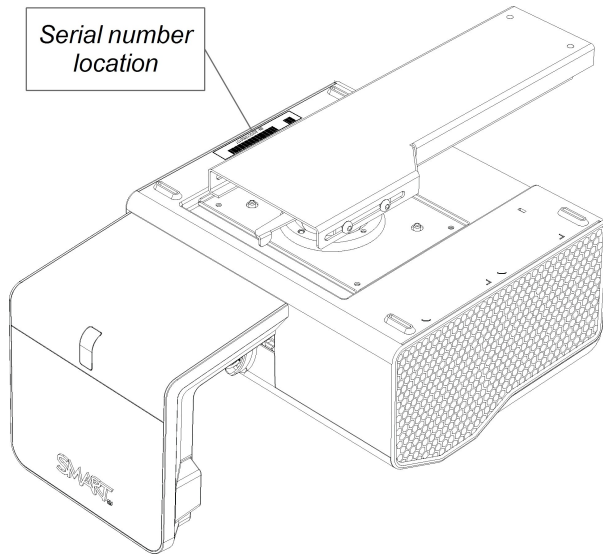

TIP

You can also access the projector's serial number through the on-screen menu. For more information, see *Information menu* on page 17.

Transporting your interactive whiteboard system

Save your original SMART Board interactive whiteboard packaging so that it's available if you need to transport your interactive whiteboard system. When required, repack it with all of the original packaging. This packaging was designed to provide optimal shock and vibration protection. If you no longer have your original packaging, purchase the same packaging directly from your authorized SMART reseller (smarttech.com/wheretobuy).

If you prefer to use your own packaging materials, make sure you adequately protect your unit. Ship your interactive whiteboard in an upright position to deter shippers from placing heavy objects on it.

Appendix A

Remotely managing your interactive whiteboard system

Web page management	50
Accessing web page management	50
Home	50
Control panel	50
Network settings	52
E-mail alerts	53
Password settings	53
Connecting your room control system to the SMART UF75 projector	54
Pin configuration on the projector's RS-232 connector	54
Serial interface settings	54
Projector programming commands	56
Projector powerstate controls	56
Command inventory	56
Value-based command methods	56
Absolute values and adjustment values	56
Video source specification values	57
Powerstate controls	58
Source selection controls	58
General source controls	59
Additional VGA source controls	60
Additional composite video source controls	61
Audio output controls	61
Network controls	62
System controls	63
Simple Network Management Protocol (SNMP)	67

This appendix includes detailed instructions on how to set up your computer or room control system to remotely manage your SMART Board 480i5 interactive whiteboard system settings through an RS-232 serial interface.

Web page management

You can access advanced setup features via the projector's web page. This web page enables you to manage the projector from a remote location using any computer connected to your intranet.

i NOTE

To access the web page, your browser must support JavaScript™. Most commonly used browsers like Internet Explorer® and Firefox® support JavaScript.

Accessing web page management

i NOTE

You can also view the IP address by accessing the projector's Network Settings menu page (see *Network settings* on page 52).

To use the management web page

1. Start your Internet browser.
2. Type the IP address in the address line field, and then press ENTER.
3. Select the menu options in the left pane to access the settings on each page.
4. Select settings or type them with your computer's keyboard, and then press the **Submit** or other action button next to each setting you change.

Home

The Home menu page displays basic projector information and enables you to select the on-screen display language.

Submenu setting	Description
Language	Displays language options
Projector Information	Displays current projector information

Control panel

This menu enables you to manage the projector audio and video status, alerts and appearances using an Internet browser.

APPENDIX A

Remotely managing your interactive whiteboard system

Submenu setting	Description
Power	Turns the projector on or puts it into Standby mode. Select the Power ON or Power OFF button.
Volume	
Mute	Turns the mute settings on or off. Select On to mute the projector's sound and Off to turn off mute.
Volume Control	
Source	

Network settings

This menu allows you to enable or disable Dynamic Host Control Protocol (DHCP) and set the network-related addresses and names.

Submenu setting	Description
DHCP	Turns the network's DHCP on or off. <ul style="list-style-type: none"> • On automatically assigns the DHCP server's IP address to the projector. • Off enables you to assign an IP address manually.
IP Address	Displays the projector's IP address in values between 0.0.0.0 and 255.255.255.255.
Subnet Mask	Displays the projector's subnet work mask number in values between 0.0.0.0 and 255.255.255.255.
Gateway	Displays the projector's default network gateway in values between 0.0.0.0 and 255.255.255.255.
DNS	Displays the projector's primary domain name number in values between 0.0.0.0 and 255.255.255.255.
Group Name	Displays the projector's workgroup name (maximum 12 characters).
Projector Name	Displays the projector's name (maximum 12 characters).
Location	Displays the projector's location (maximum 16 characters).
Contact	Displays the contact name or number for projector support (maximum 16 characters).
	Turns the SNMP's MIB function on or off.
Read-Only Community	This option sends a password with each SNMP get request that enables access to the device. <div style="background-color: #f0f0f0; padding: 5px; margin-top: 10px;"> <p>i NOTE The default for Read-Only Community is public.</p> </div>
Read/Write Community	This option sends a password with each SNMP set request that enables access to the device. <div style="background-color: #f0f0f0; padding: 5px; margin-top: 10px;"> <p>i NOTE The default for Read/Write Community is private.</p> </div>
Trap Destination Address	Displays the projector's trap destination address in values between 0.0.0.0 and 255.255.255.255. The trap destination address is the IP address of the computer assigned to handle unsolicited data generated by projector trap events, such as power down, power up or other issues.

APPENDIX A

Remotely managing your interactive whiteboard system

E-mail alerts

This menu enables you to enter your preferred address for receiving e-mail alerts and adjust related settings.

Submenu setting	Description
E-mail Alert	Select Enable to turn on or Disable to turn off the E-mail Alert function.
To	Defines the e-mail address of the e-mail alert recipient.
CC	Defines the e-mail address of the e-mail alert “copy to” recipient.
From	Defines the e-mail address of the user who sends the e-mail alert.
Outgoing SMTP server	Defines the Simple Mail Transfer Protocol (SMTP) server.
Username	Defines the SMTP server user name.
Password	Defines the SMTP server password.
Alert Condition	Sends e-mail alerts whenever Lamp Warning , Low Lamp Life , Temperature Warning and Fan Lock conditions occur. Select the settings you want, and then press Submit .

i NOTE

The projector sends an alert e-mail (SMART Alert) to your e-mail address. Press **E-mail Alert Test** to confirm your e-mail address by sending a test e-mail (SMART Alert-Test Mail).

Password settings

This menu provides a security function that allows an administrator to manage projector use and enable the Administrator Password function.

Submenu setting	Description
Password	Access Web Management for the first time by pressing the Enable button and entering a password. When the password function is enabled, the administrator password is required to access Web Management. Select Disable to turn the projector on without a password.

i NOTES

- The first time you use the password settings, the default password value is four numbers, for example, 1234.
- If you forget the projector password, refer to *Accessing the service menu* on page 45.

Connecting your room control system to the SMART UF75 projector

By connecting a computer or room control system to the RS-232 serial interface of the SMART UF75 projector, you can select video inputs, start up or shut down your interactive whiteboard system and request information such as projector lamp use, current settings and network addresses.

Pin configuration on the projector's RS-232 connector

The following table provides the pin configuration on the SMART UF75 projector. This pin configuration follows a three-wire connection so that a straight-through male-to-female RS-232 serial cable connects to the projector's serial interface in the following arrangement:

Pin number	Projector's female RS-232 connector
2	Transmit
3	Receive
5	Signal Ground

Serial interface settings

The serial interface of the SMART UF75 projector acts as a Data Communications Equipment (DCE) device and its settings can't be configured. You must configure your computer's serial communication program (such as Microsoft® HyperTerminal) or your room control system's serial communication settings with the following values:

Setting	Value
Data Rate	19.2 kbps
Data Bits	8
Parity	None
Stop Bits	1
Flow Control	None

APPENDIX A

Remotely managing your interactive whiteboard system

i NOTES

- Asynchronous mode is disabled by default in the projector.
- All commands should be in ASCII format. Terminate all commands with a carriage return.
- All responses from the projector are terminated with a command prompt. Wait until you receive the command prompt indicating that the system is ready for another command before proceeding.
- The room control feature of the projector is always on.

■ To configure your computer's serial interface

1. Turn on your computer, and then start your serial communications program or terminal emulation program.
2. Connect your computer to the serial connection cable you previously connected to the projector.
3. Configure your serial interface settings using the values in the table in the previous section, and then press ENTER.

An "invalid cmd= ? for help" message appears, and the > character appears as a command prompt on the following line.

i NOTE

If no message or an error message appears, your serial interface configuration isn't correct. Repeat step 3.

4. Type commands to configure your settings.

i NOTES

- To see a list of available commands, type ? and then press ENTER.
- If you're using a terminal emulation program, turn on your program's local echo setting to see characters as you type them.

Projector programming commands

This section documents the projector programming commands.

Projector powerstate controls

SMART UF75 projectors respond to commands only at certain power levels and times.

There are five projector power states:

- Powering (startup)
- On (operating)
- Cooling
- Confirm off
- Idle (Standby mode)

Command inventory

SMART UF75 projectors respond to the commands in the tables on the following pages. To see a list of valid commands in the projector's current power state, type ? and press ENTER.

i NOTES

- Send a command only after the projector sends a command prompt.
- Commands aren't case sensitive. Type commands exactly as they appear in the left column of the tables, with the proper value or setting in the center column.
- Check your entries carefully before entering your commands.
- Press ENTER after typing each command.
- After the projector executes a command, it generates a response.
- To avoid buffer overrun, don't send another command until you receive the next command prompt.

Value-based command methods

Absolute values and adjustment values

You can use the command's target range to set an absolute value for a command or cause an adjustment to be made to the current value. To create an adjustment command, add a plus (+) or minus (-) symbol instead of the equal symbol (=) before the value change you want to enter.

APPENDIX A

Remotely managing your interactive whiteboard system

All absolute values you enter must be within the command target range, and all adjustment values must equal a number within the command target range.

See the following example for adjusting projector brightness:

```
>get brightness  
brightness=55
```

```
>set brightness=65  
brightness=65
```

```
>set brightness+5  
brightness=70
```

```
>set brightness-15  
brightness=55
```

Video source specification values

You can use the source input field described in *Source selection controls* on next page in a command to set an absolute value or adjustment value to a source other than the active source. You can do this while the selected source is inactive, but the source device must be connected, or you receive an invalid command response.

See the following examples, where both an HDMI connector and a VGA1 input are connected:

```
>set input hdmi  
input=hdmi
```

```
>set brightness vga1=65  
brightness vga1=65
```

```
>set brightness vga1-7  
brightness vga1=58
```

APPENDIX A

Remotely managing your interactive whiteboard system

Powerstate controls

These commands place the projector in and out of Standby mode and request the projector's current powerstate. The projector's powerstate determines whether certain commands are available at that time. These settings are available even when the projector is in Standby mode.

Command	Response
on	powerstate=[field]
off	powerstate=[field]
off now	powerstate=[field]
get powerstate	powerstate=[field]

The following table describes the powerstate commands:

Command	Description
on	Turns on the projector.
off	Starts the shutdown process. A dialog box appears with the message, "Press Power Button to Turn off Projector." You must send a second Off command within 10 seconds to put the projector into Standby mode.
off now	Shuts down the projector immediately. You can't delay or cancel this command.
get powerstate	Indicates the projector's current powerstate.

The following table describes the powerstate fields:

Field	Description
Powering	The projector is turning on.
On	The projector is on.
Cooling	The projector is cooling.
Confirm off	Confirm off is a non-selectable powerstate that is returned during stage one of the two-button off sequence.
Idle	The projector is off but still receiving power (Standby mode).

Source selection controls

These commands switch input sources. The source type determines which commands can be accepted.

Command	Response	Available when in Standby mode
get input	input=[field]	Yes
set input [field]	input=[field]	No

APPENDIX A

Remotely managing your interactive whiteboard system

The following table describes the source selection commands:

Command	Description
get input	Returns the projector's current input.
set input [field]	Returns the input to one of the selectable fields.

The following table describes the source selection response fields:

Field	Description
VGA1	Switches source to the VGA 1 input connector.
VGA2	Switches source to the VGA 2 input connector.
Composite	Switches source to the Composite video connector.
S-Video	Switches source to the S-Video input connector.
HDMI	Switches source to the HDMI input port.
None	A non-selectable value that appears when you enter a "get input" command while the projector is in Standby mode.

General source controls

The following source controls apply to all input sources. HDMI connector source controls are completely described in this section. These controls are unavailable when the projector is in Standby mode. You can specify custom color values for all inputs.

These commands inform you of the current source settings.

Command	Response
get displaymode	displaymode=[current display mode setting]
get brightness	brightness=[current brightness setting]
get contrast	contrast=[current contrast setting]
get whitepeaking	whitepeaking=[current whitepeaking setting]
get degamma	degamma=[current degamma setting]
get red	red=[current red color setting]
get green	green=[current green color setting]
get blue	blue=[current blue color setting]
get cyan	cyan=[current cyan color setting]
get magenta	magenta=[current magenta color setting]
get yellow	yellow=[current yellow color setting]
get videofreeze	videofreeze=[current video freeze setting]

APPENDIX A

Remotely managing your interactive whiteboard system

These commands control the appearance of your source. These settings are unavailable when the projector is in Standby mode or when the source is disconnected. See *Value-based command methods* on page 56 for setting absolute and adjustment commands.

Command	Command target range	Response
set displaymode [target]	=SMART Presentation =Bright Classroom =Dark Classroom =sRGB =User	displaymode=[target]
set brightness [value]	=0 to =100	brightness=[value]
set contrast [value]	=0 to =100	contrast=[value]
set whitepeaking [value]	=0 to =10	whitepeaking=[value]
set degamma [value]	=0 to =3	degamma=[value]
set red [value]	=0 to =100	red=[value]
set green [value]	=0 to =100	green=[value]
set blue [value]	=0 to =100	blue=[value]
set cyan [value]	=0 to =100	cyan=[value]
set magenta [value]	=0 to =100	magenta=[value]
set yellow [value]	=0 to =100	yellow=[value]
set videofreeze [target]	=on =off	videofreeze=[target]

Additional VGA source controls

Your VGA source supports all the general source controls described in *General source controls* on previous page, as well as the commands listed in this section. These settings are unavailable when the projector is in Standby mode or when the VGA sources are disconnected.

i NOTE

Some of these commands are invalid with HDMI input and composite video sources, and will return the response “invalidcmd=[command]”.

These commands inform you of the current VGA source settings.

Command	Response
get frequency	frequency=[current frequency setting]
get tracking	tracking=[current tracking setting]
get saturation	saturation=[current saturation setting]
get tint	tint=[current tint setting]
get sharpness	sharpness=[current sharpness setting]

APPENDIX A

Remotely managing your interactive whiteboard system

These commands control the appearance of your VGA source. These settings are unavailable when the projector is in Standby mode or when the VGA source is disconnected. See *Value-based command methods* on page 56 for setting absolute and adjustment commands.

Command	Command target range	Response
set frequency [value]	=-5 to =5	frequency=[value]
set tracking [value]	=0 to =31	tracking=[value]
set saturation [value]	=0 to =100	saturation=[value]
set tint [value]	=0 to =100	tint=[value]
set sharpness [value]	=0 to =31	sharpness=[value]

Additional composite video source controls

Your composite video source supports all the general source controls described on the previous page as well as the commands listed in this section. These settings are unavailable when the projector is in Standby mode or when the composite video source is disconnected.

i NOTE

Some of these commands are invalid with HDMI input and VGA video sources, and will return the response “invalidcmd=[command]”.

These commands inform you of the current composite video source settings.

Command	Response
get saturation	saturation=[current saturation setting]
get tint	tint=[current tint setting]
get sharpness	sharpness=[current sharpness setting]

These commands control the appearance of your composite video source. See *Value-based command methods* on page 56 for setting absolute and adjustment commands.

Command	Command target range	Response
set saturation [value]	=0 to =100	saturation=[value]
set tint [value]	=0 to =100	tint=[value]
set sharpness [value]	=0 to =31	sharpness=[value]

Audio output controls

These commands control your projector’s audio output to your audio system (not included). Audio output controls aren’t defined by the video source. These settings are unavailable when the projector is in Standby mode.

APPENDIX A

Remotely managing your interactive whiteboard system

These commands inform you of the current audio output settings.

Command	Response
get volume	volume=[current volume setting]
get mute	mute=[current mute setting]
get volumecontrol	volumecontrol=[current volume control setting]
get cc	cc=[current closed captioning language setting]

These commands control your audio output settings. See *Value-based command methods* on page 56 for setting absolute and adjustment commands.

Command	Command target range	Response
set volume [value]	=-20 to =20	volume=[value]
set mute [target]	=on =off	mute=[target]
set volumecontrol [target]	=on =off	volumecontrol=[target]
set cc [target]	=cc1 =cc2 =off	cc=[target]

NOTE

Typically, cc1 displays American English subtitles, while cc2 displays other regional languages, such as French or Spanish, depending on television channel or media setup.

Network controls

These commands control your projector's network status and settings. These settings are available even when the projector is in Standby mode. You must locally set the network and VGA out commands to on, which is located in the OSD for the network abilities to work.

These commands inform you of the current network settings.

Command	Response
get netstatus	netstatus=connected netstatus=disconnected netstatus=disabled
get dhcp	dhcp=[current DHCP status]
get ipaddr	ipaddr=[current IP address]
get subnetmask	subnetmask=[current subnet work mask number]
get gateway	gateway=[current network gateway]
get primarydns	primarydns=[current primary domain name number]
get macaddr	macaddr=[current MAC address]

APPENDIX A

Remotely managing your interactive whiteboard system

These commands control your network settings.

Command	Command target range	Response
set dhcp [target]	=on =off	dhcp=[current]
set ipaddr [target]	=0.0.0.0 to =255.255.255.255	ipaddr=[current]
set subnetmask [target]	=0.0.0.0 to =255.255.255.255	subnetmask=[current]
set gateway [target]	=0.0.0.0 to =255.255.255.255	gateway=[current]
set primarydns [target]	=0.0.0.0 to =255.255.255.255	primarydns=[current]

System controls

These commands enable you to switch system settings and access system information.

These commands inform you of the current system settings. These commands are unavailable when the projector is in Standby mode.

Command	Response
get autosignal	autosignal=[current auto signal detection setting]
get lampreminder	lampreminder=[current lamp reminder setting]
get highbrightness	highbrightness=[current lamp brightness setting]
get autopoweroff	autopoweroff=[current auto power off setting]
get zoom	zoom=[current zoom setting]
get projectorid	projectorid=[current projector ID number]
get hposition	hposition=[current horizontal position setting]
get vposition	vposition=[current vertical position setting]
get aspectratio	aspectratio=[current projector aspect ratio]
get projectionmode	projectionmode=[current projection mode]
get startupscreen	startupscreen=[current startup screen setting]
get resolution	resolution=[current input resolution]
get language	language=[current language setting]
get groupname	groupname=[current projector group name]
get projectormame	projectormame=[current projector name]
get locationinfo	locationinfo=[current projector location]
get contactinfo	contactinfo=[current support contact information]
get modelnum	modelnum=[current model number]
get videomute	videomute=[current video mute setting]
get 3denable	3denable=[current 3D feature setting]
get 3dinvert	3dinvert=[current 3D invert setting]
get 3dformat	3dformat=[current 3D format]
get emergencyalertmsg	emergencyalertmsg=[current emergency alert message]
get emergencyalert	emergencyalert=[current emergency alert setting]

APPENDIX A

Remotely managing your interactive whiteboard system

These commands inform you of the current system settings. These commands are available even when the projector is in Standby mode.

Command	Response
get lamphrs	lamphrs=[current lamp hours of operation]
get syshrs	syshrs=[current projector hours of operation]
get fwverddp	fwverddp=[current projector firmware version]
get fwvnet	fwvnet=[current network firmware version]
get fwvermpu	fwvermpu=[current processor firmware version]
get fwverecp	fwverecp=[current ECP firmware version]
get vgaoutnetenable	vgaoutnetenable=[current]

APPENDIX A

Remotely managing your interactive whiteboard system

These commands control the current system settings. These commands are unavailable when the projector is in Standby mode. See *Value-based command methods* on page 56 for setting absolute and adjustment commands.

Command	Command target range	Response
set autosignal [target]	=on =off	autosignal=[target]
set lampreminder [target]	=on =off	lampreminder=[target]
set highbrightness [target]	=on =off	highbrightness=[target]
set autpoweroff [value]	=0 to =240	autpoweroff=[value]
set zoom [value]	=0 to =30	zoom=[value]
set projectorid [value]	=0 to =99	projectorid=[value]
set hposition [value]	=0 to =100	hposition=[value]
set vposition [value]	=-5 to =5	vposition=[value]
set aspectratio [target]	=fill =match =16:9	aspectratio=[target]
set projectionmode [target]	=front =ceiling =rear =rear ceiling	projectionmode=[target]
set startupscreen [target]	=smart =usercapture =preview	startupscreen=[target]

APPENDIX A

Remotely managing your interactive whiteboard system

Command	Command target range	Response
set language [target]	=Brazilian Portuguese =Czech =Danish =Dutch =English =Finnish =French =German =Greek =Iberian Portuguese =Italian =Korean =Japanese =Norwegian =Polish =Russian =Simplified Chinese =Spanish =Swedish =Traditional Chinese	language=[target]
set groupname [description]	Enter a descriptor no more than 12 characters long.	groupname=[description]
set projectormame [description]	Enter a descriptor no more than 12 characters long.	projectormame=[description]
set locationinfo [description]	Enter a descriptor no more than 16 characters long.	locationinfo=[description]
set contactinfo [description]	Enter a descriptor no more than 16 characters long.	contactinfo=[description]
set videomute [target]	=on =off	videomute=[target]
set 3denable [target]	=on =off	3denable=[target]
set 3dinvert [target]	=leftright =rightleft	3dinvert=[target]
set 3dformat [target]	=interleaved =overunder	3dformat=[target]
set emergencyalertmsg [description]	Enter a descriptor no more than 60 characters long.	emergencyalertmsg=[description]
set emergencyalert [target]	=on =off	emergencyalert=[target]

APPENDIX A

Remotely managing your interactive whiteboard system

These commands control the current system settings. These commands are available even when the projector is in Standby mode.

Command	Command target range	Response
set restoredefaults	[none]	restoredefaults=done
set lamphrs [target]	=0	lamphrs=0
set vgaoutnetenable [target]	=on =off	vgaoutnetenable=[target]

NOTE

The VGA Out and Network settings features are off by default. Select **On** to activate these features.

Simple Network Management Protocol (SNMP)

SMART UF75 projectors support a list of SNMP commands as described in the management information base (MIB) file. You can download this file by browsing to smarttech.com/software and clicking the MIB files link in the *Hardware* section for the SMART UF75 projector.

The SNMP agent supports SNMP version 1. Upload the MIB file to your SNMP management system application, and then use it as described in your application's user guide.

Appendix B

Hardware environmental compliance

SMART Technologies supports global efforts to ensure that electronic equipment is manufactured, sold and disposed of in a safe and environmentally friendly manner.

Waste Electrical and Electronic Equipment regulations (WEEE directive)

Waste Electrical and Electronic Equipment regulations apply to all electrical and electronic equipment sold within the European Union.

When you dispose of any electrical or electronic equipment, including SMART Technologies products, we strongly encourage you to properly recycle the electronic product when it has reached end of its life. If you require further information, please contact your reseller or SMART Technologies for information on which recycling agency to contact.

Restriction of Certain Hazardous Substances (RoHS directive)

This product meets the requirements of the European Union's Restriction of Certain Hazardous Substances (RoHS) directive 2002/95/EC.

Consequently, this product also complies with other regulations that have arisen in various geographical areas, and that reference the European Union's RoHS directive.

Batteries

Batteries are regulated in many countries. Check with your reseller to find out how to recycle used batteries.

There are special regulations that must be met when shipping a product that has a lithium ion battery packaged with the product or shipping a lithium ion battery. When returning a SMART Technologies

APPENDIX B

Hardware environmental compliance

product which contains a lithium ion battery or returning a lithium ion battery, call SMART Technologies RMA for information on these special shipping regulations:

- 1.866.518.6791, Option 4 (U.S./Canada)
- 1.403.228.5940 (all other countries)

Packaging

Many countries have regulations restricting the use of certain heavy metals in product packaging. The packaging used by SMART Technologies to ship products complies with applicable packaging laws.

China's Electronic Information Products regulations

China regulates products that are classified as EIP (Electronic Information Products). SMART Technologies products fall under this classification and meet the requirements for China's EIP regulations.

U.S. Consumer Product Safety Improvement Act

The United States has enacted the *Consumer Product Safety Improvement Act* which limits the lead (Pb) content in products used by children. SMART Technologies is committed to complying with this initiative.

Appendix C

Customer support

Online information and support

Visit www.smarttech.com/support to view and download user's guides, how-to and troubleshooting articles, software and more.

Training

Visit www.smarttech.com/trainingcenter for training materials and information about our training services.

Technical support

If you experience difficulty with your SMART product, please contact your local reseller before contacting SMART Support. Your local reseller can resolve most issues without delay.

i NOTE

To locate your local reseller, visit www.smarttech.com/wheretobuy.

All SMART products include online, telephone, fax and e-mail support:

Online	www.smarttech.com/contactsupport
Telephone	+1.403.228.5940 or Toll Free 1.866.518.6791 (U.S./Canada) (Monday to Friday, 5 a.m. – 6 p.m. Mountain Time)
Fax	+1.403.806.1256
E-mail	support@smarttech.com

Shipping and repair status

Contact SMART's Return of Merchandise Authorization (RMA) group, Option 4, +1.866.518.6791, for shipping damage, missing part and repair status issues.

APPENDIX C

Customer support

General inquiries

Address	SMART Technologies 3636 Research Road NW Calgary, AB T2L 1Y1 CANADA
Switchboard	+1.403.228.5940 or Toll Free 1.866.518.6791 (U.S./Canada)
Fax	+1.403.228.2500
E-mail	info@smarttech.com

Warranty

Product warranty is governed by the terms and conditions of SMART's "Limited Equipment Warranty" that shipped with the SMART product at the time of purchase.

Registration

To help us serve you, register online at www.smarttech.com/registration.

Index

3

3.5 mm audio connectors 20

A

accessories
 included 3
 optional 4
aspect ratios 23-25
audio
 connections for 20
 controlling volume of 51, 62
 muting 11, 62
 resolving issues with 41

B

batteries 9, 69
Blu-ray 25

C

cameras 25
cautions ii
Chinese regulations 70
closed captioning 62
color wheel 39
composite video connections 25, 59, 61
connection diagrams
 projector 19
consumer product safety 70
contact information 72
contact person 52

D

DHCP 52, 62
DNS 52, 62
document cameras 25
documentation 71
dust v
DVDs 25

E

e-mail alerts 53
EIP regulations 70
electrostatic discharge v
emissions v
environmental requirements v
European Union regulations 69

F

fans 38
flickering 43
focus 18

G

general inquiries 72

H

HD signal compatibility 24
HDMI connections 20, 59
head space clearance 6
height 6
humidity v

INDEX

- I**
- image
 - adjusting 19
 - correcting alignment issues with 36
 - focusing 18
 - resolving issues with 42
 - important information iii
 - indicator lights 36
 - input selection 51, 58
 - inquiries 72
 - installation
 - choosing a height 6
 - choosing a location 6
 - securing 8
 - interactive whiteboard
 - about 2
 - indicators and controls of 36
 - maintaining 27
 - using 21
 - IP address 52, 62
- L**
- lamp module
 - cleaning 27
 - replacing 29
 - resolving issues with 39
 - LEDs See indicator lights
 - letterboxing 23-24
 - light sources 6
 - Limited Equipment Warranty 72
 - lithium ion batteries 69
 - location 6, 52
- M**
- MAC address 62
 - MAC support 23
 - mounting template 6
 - mute control 11, 62
- N**
- native video formats 23
 - network communication 20, 40, 52, 62
- O**
- online support 71
 - options 4
 - original packaging 47
- P**
- packaging 70
 - passwords 46, 53
 - pen 3
 - pen tray
 - about 2
 - peripheral sources 25
 - pillarboxing 23-24
 - power 20, 51, 56, 58
 - projector
 - about 3
 - adjusting settings for 12
 - adjusting the image of 19
 - cleaning 27
 - connection diagram for 19
 - displaying the name of 52
 - focusing the image of 18
 - installing 5
 - lights and status of 36
 - locating the serial number on 46
 - remotely managing 49
 - replacing the lamp of 29
 - routing cables from 7
 - securing to the boom 8
 - troubleshooting 37
 - using your remote control with 9
 - video format compatibility for 23
- Q**
- quad VGA support 23

INDEX

R

RCA jacks	20
refresh rates	23
registration	72
remote control	
about	4
installing the battery	9
using the buttons	11
RJ45 connector	20
RoHS directive	69
room control	49
RS-232 serial interface	20, 54

S

S-video connections	20, 25, 59
SD signal compatibility	24
serial interface	See RS-232 serial interface
serial number	46
signal loss	42
SMART Board interactive	See interactive whiteboard
whiteboard	whiteboard
SMART Support	71
SMART UF75 or UF75w	See projector
projector	projector
SMTP	53
SNMP	67
sound	See audio
subnet mask	52, 62
SVGA support	23
SXGA support	23

T

Technical Support	71
temperatures, operating and storage	v
training	71
transportation	47
trap destination address	52
troubleshooting	35
troubleshooting articles	71

U

U.S. regulations	70
UF75 or UF75w projector	See projector
USB receptacles	20
user's guides	71
UXGA support	23

V

VGA connections	20, 59-60
VGA support	23
video	
connections for	20
format compatibility for	23
resolving issues with	41
volume control	62

W

warnings	i
warranty	72
water and fluid resistance	v
web page management	50
WEEE directive	69
whiteboard	See interactive whiteboard

X

XGA support	23
-------------	----

SMARTTM

Toll Free 1.866.518.6791 (U.S./Canada)
or +1.403.228.5940
www.smarttech.com