

Universal Frequency Counter

PM6669

Operators Manual

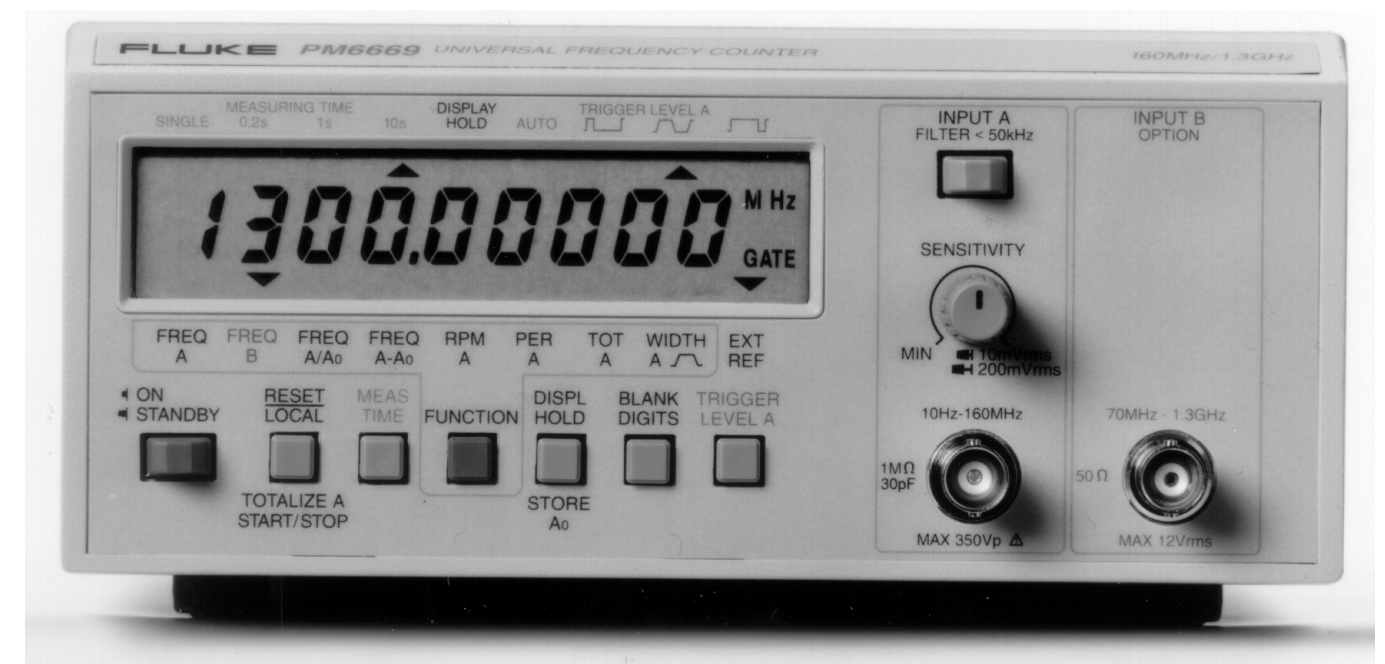

FLUKE[®]

CONTENTS

SAFETY	2	Selecting Output Separator	24
Introduction	2	How to Select Function	24
PRODUCT PRESENTATION	3	Selecting Measuring-Time.....	24
General	3	Selecting Triggering.....	25
Rear View.....	3	Totalize Start/Stop	25
Front View	4	Free-Run/Triggered	25
INSTALLATION	5	Service Request	26
Unpacking	5	Status Byte	26
Voltage-Range Selection	5	Output Mode.....	27
Grounding	5	Bus Learn	30
Connecting External Reference.....	6	Programming Data Out	30
Installing Options	6	What Happens When I Switch to Local?.....	30
Calibrating the MTCXO.....	6	Summary of Bus Commands	31
OPERATING INSTRUCTIONS	8	Programming Examples.....	32
Using the Frequency Counter	8	SPECIFICATIONS	35
Battery Unit	20	Measuring Functions	35
Error Codes.....	20	Definitions.....	36
GPIB-INTERFACE OPERATION	21	Input specifications.....	36
Introduction	21	General Information.....	37
What Can I Do Using the Bus?.....	21	Auxiliary Functions	38
Connecting the Controller	22	Optional Accessories.....	38
Giving the Counter an Address.....	22	Ordering Information	40
Checking the Communication.....	22	APPENDIX 1	41
Two Ways of Programming.....	23	Checking the Sensitivity of Counters	41
Syntax	23	INDEX	43

SAFETY

Introduction

Read this page carefully before you install and use the PM 6669 Frequency Counter.

This Frequency Counter has been designed and tested in accordance with IEC publication 1010-1, and CSA 22.2 No.231, and has been supplied in a safe condition. The user of this instrument must have the required knowledge of PM 6669. This knowledge can be gained by thoroughly studying this manual.

Safety Precautions

Use generally-accepted safety procedures, in addition to the safety precautions stated in this manual, to ensure personal safety and safe operation of the Frequency Counter.

Caution & Warning Statements

You will find specific warning and caution statements, where necessary throughout the manual. Do not carry out repairs or adjustments to the Frequency Counter without reading the Service Manual, which contains the relevant warnings for such activities.

CAUTION: Indicates where incorrect operating procedures can cause damage to, or destruction of, equipment or other property.

WARNING: Indicates a potential danger that requires correct procedures or practices in order to prevent personal injury.

Symbols



Indicates where the protective ground lead is connected inside the instrument. Never unscrew or loosen this screw.

If in doubt about safety

Whenever you suspect that it is unsafe to use the instrument, you must make it inoperative, clearly mark it to prevent its further operation, and inform the Fluke service Centre.

E.g. The instrument is likely to be unsafe if it is visibly damaged.

PRODUCT PRESENTATION

General

The PM 6669 is a compact, high resolution, reciprocal Frequency Counter which performs many functions. A number of options are available i.e. HF-input, GPIB-interface, high stability oscillator, and rechargeable battery for field use.

A rack-mount kit and a carrying case are also available as accessories.

Rear View

- A) Rear feet.
- B) Screws for removing the cover.
- C) External-reference-input, BNC connector.
- D) Voltage-range selector.
- E) Power-inlet socket.
- F) GPIB interface-connector (optional).
- G) GPIB address-selector (option).

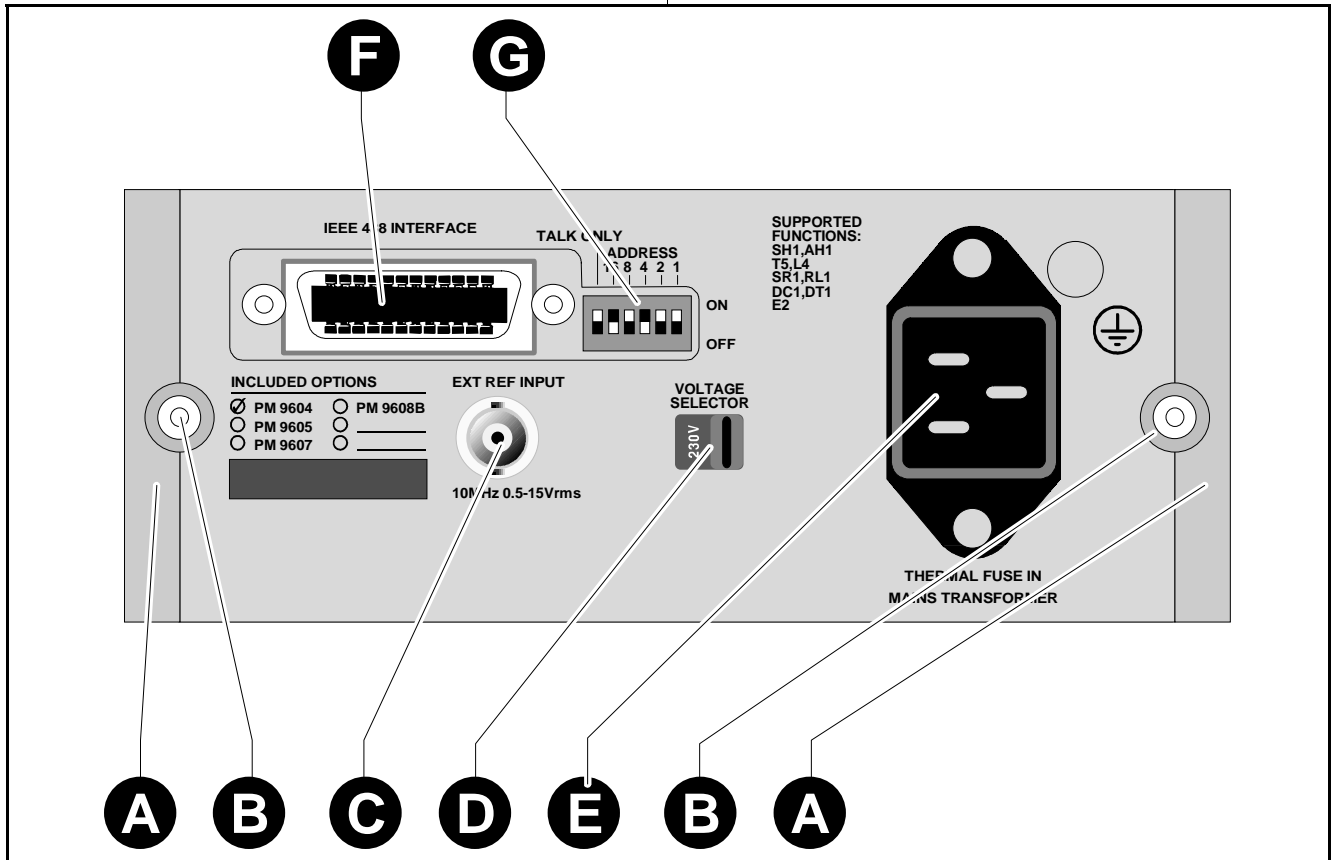

Figure 1 Rear View.

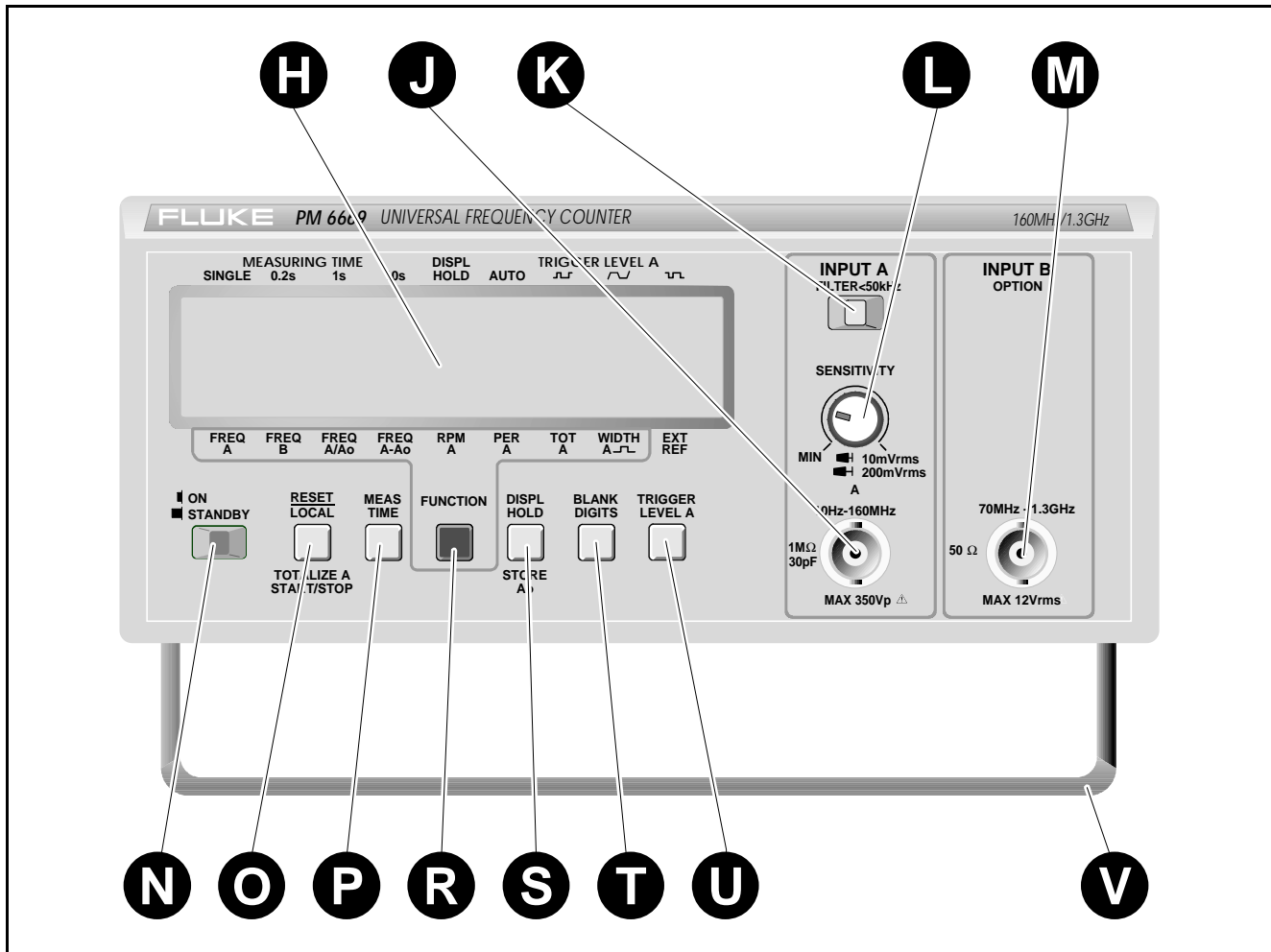

Figure 2 Front View.

Front View

- H) Large LCD-display.
- J) Input-A BNC-connector.
- K) Sensitivity control with dual-range push-in/pull-out switch.
- L) 50 kHz filter switch (Input-A).
- M) Input-B BNC-connector (optional).
- N) Power switch.
- O) Reset button, doubles as Local button if the Frequency Counter is equipped with a GPIB interface. Starts and stops counting if the TOT A function is selected.
- P) Measuring-time selector-button. *
- R) Function-selector button. *
- S) Display-hold button. Freezes the display. The button is also used for storing A_0 .
- T) Blank digits button. Blanks out one digit for each depression of the button, from the right to the left of the display. (No rounding off).
- U) Trigger level setting button.
- V) Tilting support.

* The selected function is indicated on the display. A short press on the button moves the cursor one step to the right. A long press makes the cursor scroll.

INSTALLATION

Unpacking

If the Frequency Counter is cold, leave it in the cardboard box until it has reached normal room temperature.

- Lift the Frequency Counter out of the box.
- Remove the polystyrene supports.
- Unpack the Frequency Counter from the plastic bag.
- Reverse the procedure to pack.

Check List

Has the Frequency Counter been damaged in transport? If it has, file a claim with the carrier immediately, and notify the Fluke sales & service organization to make repair or replacement of the instrument easier.

- Check that the package contains the following items in addition to the Frequency Counter:
 - This Operators' Manual
 - A power cable with protective earth conductor
 - A Battery unit if ordered *)
 - An MTCXO oscillator if ordered *)
 - A GPIB interface if ordered *)
 - An HF-input if ordered *)

*) Labels on the rear panel indicate which options are fitted in your Frequency Counter.

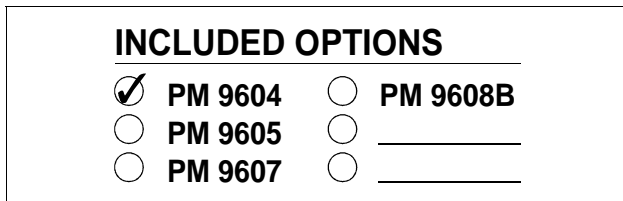

Figure 3 Options Label on Rear Panel.

Voltage-Range Selection

Set the Frequency Counter to the local line voltage before connecting it. As delivered the Frequency Counter may be set to either 115 V or 230 V. The setting is indicated on the voltage range selector on the rear panel.

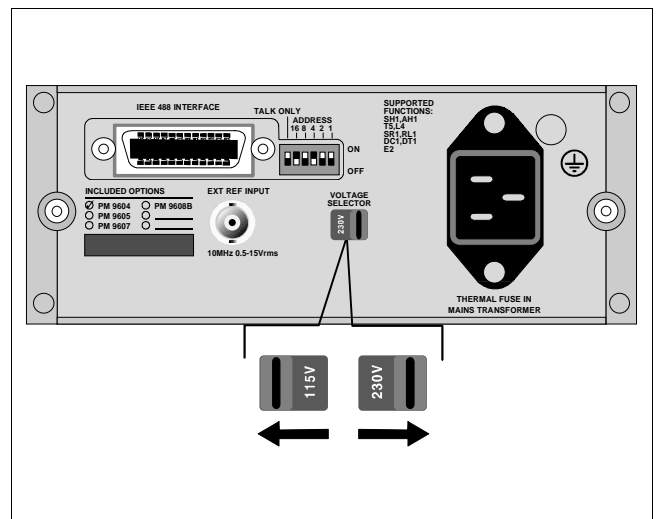

Figure 4 Location of Voltage Range Selector.

If the voltage range setting is incorrect, set the selector in accordance with the local voltage before connecting the power cable to the line.

Grounding

The Frequency Counter is connected to ground via a sealed three-core power cable, which must be plugged into a socket outlet with a protective ground terminal. No other grounding is permitted for this Frequency Counter. Extension cables must always have a protective ground conductor.

WARNING: Never interrupt the protective grounding intentionally. Any interruption of the protective ground connection inside or outside the instrument, or disconnection of the protective ground terminal is likely to make the instrument dangerous.

Connecting External Reference

If you wish to use an external 10 MHz reference frequency source, connect it via a BNC-cable to the EXT REF INPUT on the rear panel of the Frequency Counter.

When the Frequency Counter starts measuring, it automatically detects the external reference and begins to use it. The EXT REF indicator on the display is switched on.

Installing Options

Introduction

The options ordered at the same time as the Frequency Counter are normally factory-installed. Other options can be fitted when needed.

The options fit inside the Frequency Counter, but not all at the same time: The HF-input, the high stability-oscillator and either of the GPIB-interface or the Battery-unit can be installed in one and the same Frequency Counter.

Calibrating the MTCXO

The MTCXO Time-base can easily be recalibrated to any 10 MHz reference. To maintain the accuracy of the MTCXO, use a reference with an accuracy of $3 \cdot 10^{-8}$.

The PM 9691 oven-enclosed oscillator used in Fluke counters version /.5. meet this requirement, if calibrated.

Preparations

If you remove the cover when counter has been switched on, the temperature of the MTCXO will rapidly drop about 10°C. Since the MTCXO must have a stable temperature when calibrated you must wait an hour between removing the cover and calibrating.

If the counter has been switched off more than three hours, you can calibrate it directly.

Removing the Cover

WARNING: When you remove the cover you will expose live parts and accessible terminals which can be dangerous to life.

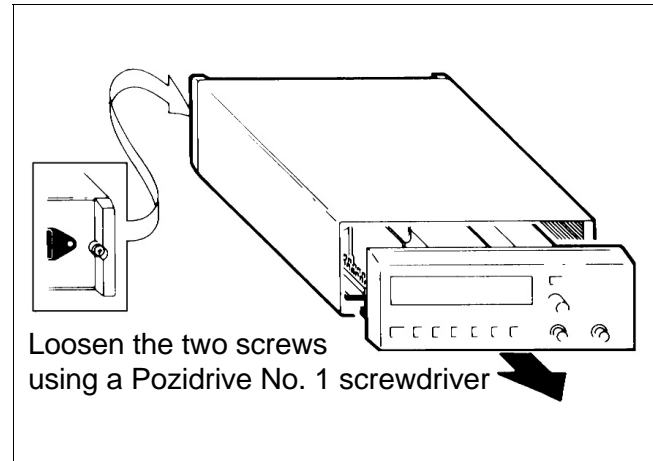

Figure 5 Loosen These Screws to Remove Cover.

- Make sure that the power cable is disconnected.

WARNING: Although the power switch is in the off position, the line voltage is present on the printed circuit board.

- Loosen the two screws in the rear feet.
- Grip around the front panel and pull the Frequency Counter out of the cover.

Calibration Procedure

- Remove the cover from the counter.
- Allow the MTCXO to adapt the new ambient temperature. (See 'Preparations'.)
- Connect the 10 MHz reference to Input-A.
- Switch ON the counter.
- Adjust the sensitivity control so that the counter counts properly.
- Hold down the CALIB-button, on the main printed-circuit board in the counter, and press the Reset-button.

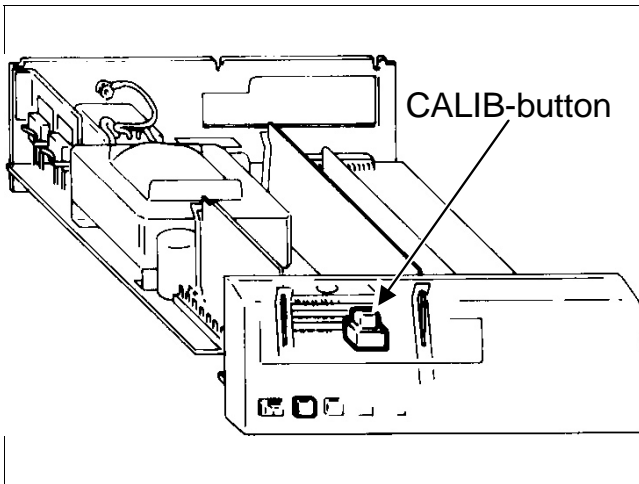

Figure 6 Location of the CALIB-Button.

- Wait about 20 seconds, until the display shows 10.000000 MHz. Now the oscillator is calibrated.
- Switch OFF the counter and disconnect the 10 MHz reference.

Fit the cover.

OPERATING INSTRUCTIONS

Using the Frequency Counter

CONTROL

OPERATING THE CONTROL

DISPLAY

GPIB-CODE



POWER, a two-position mechanical push-button. Pressed = ON, Released = OFF

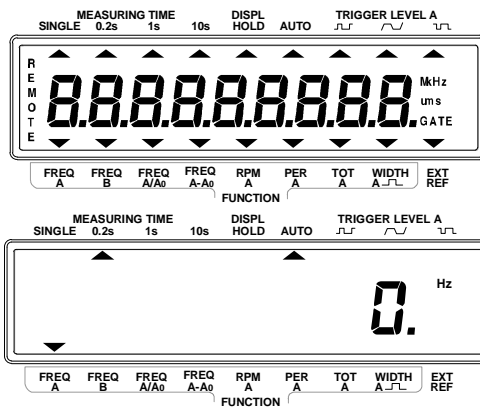

No control possible but **D** gives the same settings as after power-ON.

FUNCTION



A short depression of the FUNCTION key moves the cursor in the lower edge of the display one step to the right. If the key is held depressed, the cursor will scroll to the right until released. When the cursor reaches the rightmost position it jumps back to the leftmost position and continues from there.

One code for each function, - see below:

FUNCTION



Move function cursor to **FREQ A**

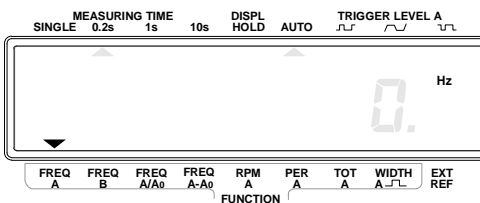

FREQ A

FUNCTION AND RANGE**HINTS AND COMMENTS**

Switches the power ON and OFF. When switched on, the built in microprocessor switches on all segments of the display then it runs a power-up test, checking the measuring-logic of the Frequency Counter before the counter starts working. This test takes about 2 seconds.

WARNING:The power switch operates on the secondary side of the transformer. The power cable must be disconnected from the line outlet socket if it is necessary to completely isolate the Frequency Counter from the line.

If an error is found, an error code will be displayed. Try switching the Frequency Counter off and on again. If error code 01 - 03 persists, call Fluke service. Look on the last page in this manual for Phone No. and address.

Error 01 = RAM memory error
 Error 02 = Measuring logic error
 Error 03 = Internal bus error
 Error OF = Overflow in the counting registers

Selects one of the nine measuring functions available.

The cursor does not stop at **FREQ C** if no Input-C HF-input is installed.

Reciprocal frequency measurement of the signal at Input-A.

If the signal is sine shaped and the input AC coupled, the minimum input frequency is 20 Hz (at specified sensitivity).

Range:

0.1 Hz to 16 MHz (SINGLE measuring-time)
 1 Hz to 160 MHz (0.2, 1, and 10 s measuring-time)

CONTROL OPERATING THE DISPLAY GPIB-CODE

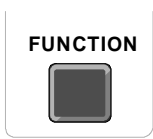

Move function cursor to
FREQ B

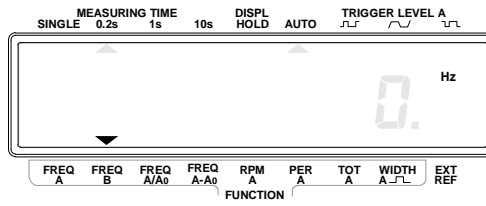

FREQ B



Move function cursor to
FREQ A/A₀

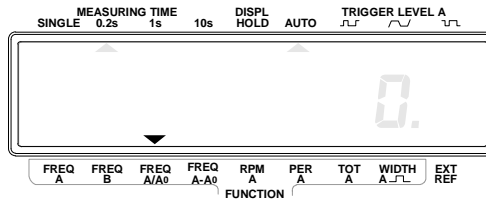

Not bus
selectable

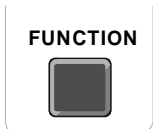

Move function cursor to
FREQ A-A₀

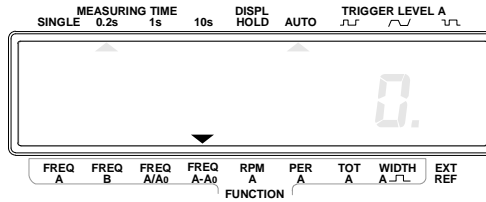

Not bus
selectable



Move function cursor to
RPM A

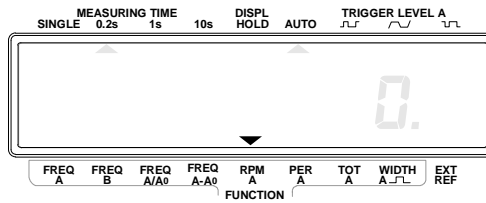

RPM A



Move function cursor to
PER A

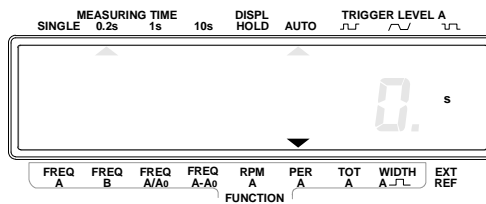

PER A



Move function cursor to
TOT A

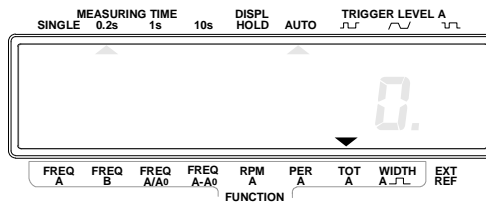

TOTM A

FUNCTION AND RANGE

HINTS AND COMMENTS

Reciprocal frequency measurement of the signal at Input-B.

The cursor does not stop at FREQ B if no Input-B HF-input is installed.

Range:

70 to 1300 MHz (PM 9608B)

The counter divides the frequency on Input-A by a constant, A_0 , that is stored in the counter in the following way:

If you select this function without storing A_0 , Frequency A will be displayed.

- 1) Connect a signal with the frequency to be stored as A_0 to Input-A.
- 2) Select FREQ A.
- 3) Depress the DISPL HOLD key and hold it depressed until the DISPL HOLD indicator is switched off again. Now A_0 is stored.
- 4) Select FREQ A/ A_0 .
- 5) Connect the frequency to be measured to Input-A.

This function is convenient when an oscillator is to be tuned to the frequency of a reference oscillator. It is much easier to adjust until the display shows 1.0000000 than 7.1223678.

The counter subtracts a constant, A_0 , from the frequency at Input-A. You can read about how to store A_0 in the description for FREQ A/ A_0 .

If you select this function without storing A_0 , Frequency A will be displayed.

This function can e.g. be used in a radio to display the received frequency; Set the intermediate frequency as the constant A_0 . Select FREQ A- A_0 and measure the frequency of the local oscillator, and the display will show the received frequency.

The frequency on Input-A is multiplied by 60 and displayed as Revolutions Per Minute.

Range: 6 RPM to 720 000 000 RPM.

When you select SINGLE, the Frequency Counter measures one period, the range is: 100 ns to 200 000 000 s (about 6 years and four months!).
When you select 0.2, 1, and 10 s Measuring-time, the Frequency Counter divides the input frequency by 10 and measures the average period for the No. of cycles in that time.

Use SINGLE when the input frequency is low. This shortens the measuring time considerably since one cycle is measured instead of 10.

Range:

8 ns to 1 s.

The Frequency Counter counts the total number of pulses fed to Input-A. You start and stop the totalizing with the TOTALIZE START/STOP key (RESET/LOCAL). If you keep this key depressed for more than one second, the total sum will be reset.

k on the display indicates kilo-pulses (1000) and **M** indicates Mega-pulses(1 000 000).

The Measuring-time indicator is switched off in TOT A MAN.

Range:

0 to $1 \cdot 10^{15}$ pulses

CONTROL	OPERATING THE CONTROL	DISPLAY	GPIB-CODE
---------	-----------------------	---------	-----------

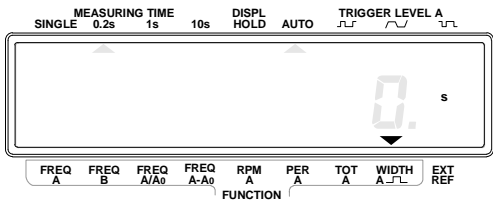
<p>FUNCTION</p> 	<p>Move function cursor to WIDTH A</p>		<p>WIDTH A or PWIDTH A</p>
--	---	--	-----------------------------------

<p>MEAS TIME</p> 	<p>MEAS TIME is operated in the same way as the functions control, see page 8.</p>		<p>MTIME <num> where <num> is the time in seconds.</p> <p><i>Range:</i> 10 ms to 10 s. 0 = Single</p>
---	---	--	--

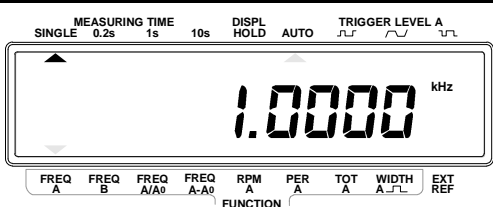
<p>MEAS TIME</p> 	<p>Move the measuring-time cursor to SINGLE</p>		<p>MTIME 0</p>
---	--	---	-----------------------

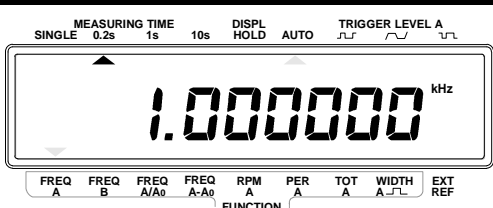
<p>MEAS TIME</p> 	<p>Move the measuring-time cursor to 0.2 s</p>		<p>MTIME 0.2</p>
---	---	--	-------------------------

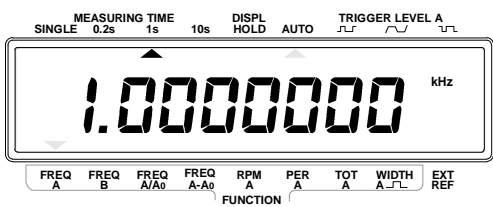
<p>MEAS TIME</p> 	<p>Move the measuring-time cursor to 1 s</p>		<p>MTIME 1</p>
---	---	--	-----------------------

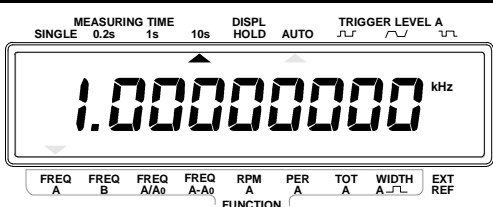
<p>MEAS TIME</p> 	<p>Move the measuring-time cursor to 10 s</p>		<p>MTIME 10</p>
---	--	--	------------------------

FUNCTION AND RANGE**HINTS AND COMMENTS**

The counter measures the positive pulse width of the signal on Input-A.

Range:

100 ns to 200 000 000 s.

If you are interested in the negative pulse width instead; first measure the period and make a note of the result, then measure the pulse width and subtract it from the period reading.

The set Measuring-time controls the time during which the main gate is opened, allowing pulses to enter the counting logic. A longer Measuring-time gives higher resolution readouts with more digits displayed.

If you wish to do one measurement instead of repetitive measurements, see DISPL HOLD.

The time the gate is open is not exactly the preset Measuring-time, because the Frequency Counter synchronizes the measurement with the input signal in order to measure complete periods. If the period of the input signal is longer than the set Measuring-time, the main gate does not close again until the period is completed.

For PER A and WIDTH exactly one period or one time interval is measured. The minimum result possible is 100 ns.

The input frequency is limited to 16 MHz for FREQ A, PER A, and RPM A.

The display time will be 100 ms.

If external reference is used, the EXT REF indicator will not be switched-on until after the first measurement.

When set to SINGLE, FREQ A and, RPM A, the Measuring-time is one cycle of the input signal or 3 ms, whichever is longest. When set to SINGLE and FREQ B, the Measuring-time is 3 ms.

A Frequency-A measurement will result in 6-7 digits on the display.

A Frequency-A measurement will result in 7-8 digits on the display.

A Frequency-A measurement will result in 8-9 digits on the display.

CONTROL OPERATING THE CONTROL DISPLAY GPIB-CODE

TRIGGER LEVEL A



The **TRIGGER LEVEL A** control is operated in the same way as the functions control, see page 8.

One code for each trigger level offset. See below.

TRIGGER LEVEL A



Move Trigger Level A cursor to **AUTO**.

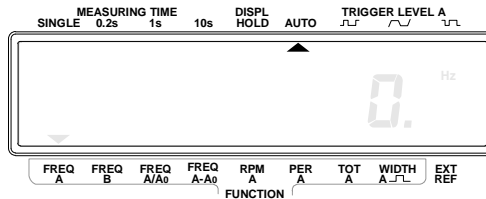

TLO AUT

TRIGGER LEVEL A



Move Trigger Level A cursor to

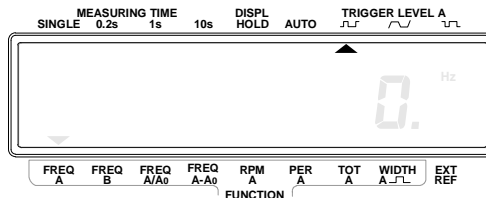

TLO POS

TRIGGER LEVEL A



Move Trigger Level A cursor to

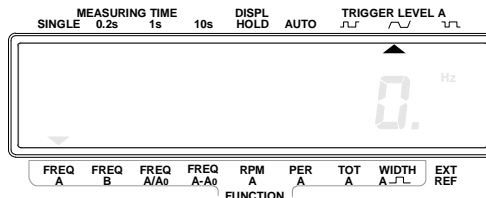

TLO SYM

TRIGGER LEVEL A



Move Trigger Level A cursor to

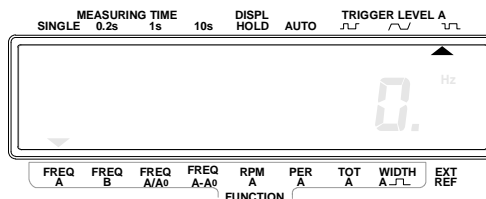

TLO NEG

BLANK DIGITS



Each depression of the **BLANK DIGITS** key blanks out one digit starting from the right (Least Sig-nificant Digit). When all digits are blanked out, the next depression removes the blanking.

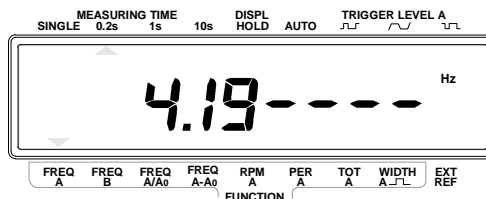

Not bus controllable

FUNCTION AND RANGE

HINTS AND COMMENTS

The normal trigger level of the AC-coupled Input-A is 0 V. This is ideal for symmetrical signals like sine-waves, since their average DC component is 50 % of Vp-p.

Non-symmetrical signals however, might fail to trigger if the trigger level is 0 V. Therefore there are three trigger level settings available; one for small duty factors, one for symmetrical wave forms and one for large duty factors.

When set to Auto the counter first tries the trigger level for symmetrical signals. If that does not work, it tries the other settings.

Auto does not work if TOT A is selected.

Range: Auto works with input frequencies from 100 Hz and up.

Use this setting if the duty factor is below 25 %. A positive offset voltage is added to the trigger level.





Use this setting if the duty factor is between 25 % and 75 %.
The trigger level is 0 V.

Use this setting if the duty factor is below 75 %. A negative offset voltage is added to the trigger level.

Each digit that is blanked out is removed and replaced by a -. The numerical value on the display is not rounded off. The blanking is cleared by reset, changing settings or when all digits are blanked and you press the BLANK DIGITS key once more.

It is often possible for the counter to trigger on unsymmetrical signals even though the symmetrical triggering is selected, provided that the sensitivity is high enough. This however, gives poor noise immunity.

If you don't know the duty factor of the input signal, select Auto. If that does not work (too low input frequency) do as follows;

- a) Set the sensitivity to max.
- b) Select Trigger level .
- c) Reduce the sensitivity until the gate indicator stops blinking.
- d) Check if trigger level  or  makes the gate indicator start blinking again. If it does, leave the trigger level in that position, otherwise return to trigger level .
- e) Turn the sensitivity down until the gate indicator stops blinking, then up slightly until it starts again. The trigger level is now correct.

This function is used to blank the display of irritating, unstable digits.

CONTROL	OPERATING THE CONTROL	DISPLAY	GPIB-CODE
---------	-----------------------	---------	-----------

RESET LOCAL

TOTALIZE A START/STOP

RESET/LOCAL, a short press is enough for Reset. When the remote indicator is on, a press will cause the counter to switch back to LOCAL, i.e. control from the front panel.

X starts a new measurement.

TOTALIZE START/STOP, one press starts totalizing, the next press stops.

GATE OPEN starts and **GATE CLOSE** stops Totalize MAN.

DISPL HOLD

STORE A0

Switches 'on' or 'off' **DISPL HOLD** when depressed.

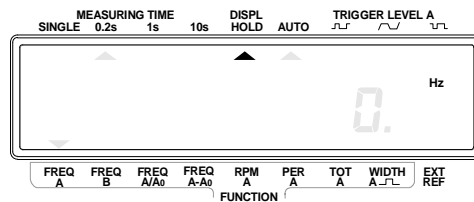

Not bus controllable, but Free-run OFF will give a similar function; See GPIB-bus operation.



Connect the signal to **INPUT-A** via a BNC-cable.



Connect the signal to **INPUT-B** via a BNC-cable.

FUNCTION AND RANGE

When reset is depressed, the display and counting registers are cleared. When reset is released, a new measurement is started. The Measuring-time-, Function and display hold- settings are not affected.

If the TOT A function is selected, the RESET/LOCAL key functions as a START/STOP key. One press starts the counting and the next press stops it. A long depression results in reset.

Display hold freezes the display, but not until the measurement in process has been finished. A new measurement can always be initiated via the RESET key.

Store A_0 is used to store the constant used in functions $FREQ A/A_0$ and $FREQ A-A_0$. The procedure is described under FUNCTIONS, $FREQ A/A_0$.

Use this input for all functions except $FREQ B$.

Range: 10 Hz to 160 MHz
 Impedance: 1 M // 30 pF
 Min. pulse duration: 4 ns

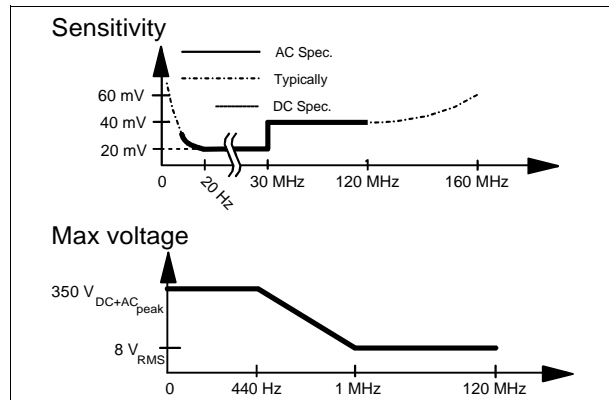

This is the HF-input which must be used when the $FREQ-B$ function is selected. If the Frequency Counter does not include the Input-B option, the BNC-connector is replaced by a plastic plug.

Range:

70 to 1300 MHz.

Impedance:

50 Ω

Sensitivity:

10 mV_{RMS} up to 900 MHz,
 15 mV_{RMS} 900-1100 MHz
 and 40 mV_{RMS} above.

Max voltage:

12 V_{RMS}

HINTS AND COMMENTS

When the counter is controlled from the GPIB-Bus, the LOCAL key can be disabled via the 'Local Lock out' command.

At higher frequencies; use a 50 Ω termination type PM 9585 to avoid interference caused by impedance mis match.

The illustration below shows which function block each of the input controls affect.

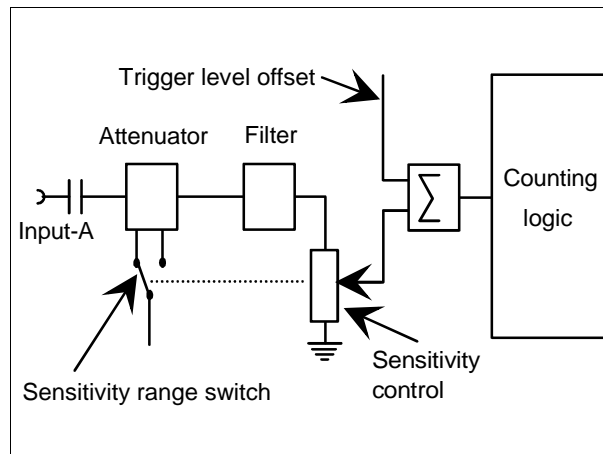
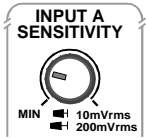

Figure 7. Input circuit block diagram.

CONTROL	OPERATING THE CONTROL	DISPLAY	PIB-CODE
---------	-----------------------	---------	----------



Pull the SENSITIVITY knob to switch to **AC** coupling. Depress the knob to switch to **DC** coupling.
 NOTE: The potentiometer controls the sensitivity when AC-coupled and Trigger Level when DC-coupled. Turn the knob clockwise to increase and counter clockwise to decrease the trigger level or sensitivity.

Not adjustable from the bus.



One two-position switch. Depress to switch on the **FILTER** and release to switch it off.

Not bus controllable.

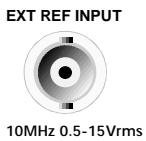

Connect an external 10 MHz frequency source to the BNC-connector on the rear panel of the Frequency Counter marked **EXT REF INPUT**.

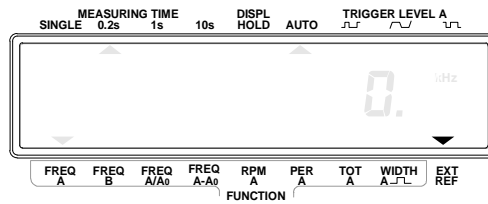

Not bus controllable.

FUNCTION AND RANGE

HINTS AND COMMENTS

For frequency-, period-, and ratio measurements:

Select AC coupling and set the sensitivity so that the hysteresis band of the Frequency Counter is about half the amplitude of the signal.

For time measurements:

Select DC coupling and set the trigger level to the desired level using the 1 V/division scale on the front panel.

1. Set the sensitivity knob fully counter clockwise.
2. Turn it until the input triggers.
3. Continue turning to the 20 mV_{RMS} position, or to the position where the display turns unstable due to noise.
4. Set the knob to the position inbetween these two points.

You will have a stable reading.

If the sensitivity is too high, the Frequency Counter will be triggered by noise and interference instead of by the signal.

The filter works on Input-A where it suppresses signals with higher frequencies than 50 kHz.

Filter suppression: 40 dB at 1 MHz

The filter can also be used to suppress HF-interference on signals with higher frequencies than 50 kHz, but then the sensitivity of the input will be reduced.

NOTE: Never use the filter when measuring TIME A-B since the filter delays the signal on Input-A.

The Frequency Counter automatically detects if a suitable signal is connected to the EXT- REF Input-connector.

Suitable signal:

10 ± 0.1 MHz, 0.5 to 15 V_{RMS} Sine wave.

Use external reference when the measurement requires ultra-high stability.

The Frequency Counter must still have the internal time base even if an external reference frequency is used.

If single is selected, the EXT REF indicator on the display is not switched on until after the first measurement.

Battery Unit

Operation

When a battery unit is installed, the counter can operate for 3 hours without mains supply. The display starts blinking shortly before the battery is discharged.

The counter charges the battery automatically when connected to the mains, no matter how the Power-switch is set. Charging a discharged battery to 75 % of full capacity will take 7 hours, and to full capacity, 24 hours.

If the counter is connected to the mains and switched on, it will not switch to battery operation if you disconnect the mains. You must first switch the counter OFF with the power switch, then ON again before the battery unit supplies the counter.

Battery Care

The capacity of the rechargeable battery degrades if the counter is not powered by the battery frequently. To keep the battery from degrading, cycle the battery, from fully charged to fully discharged, occasionally.

The capacity of a degraded battery can be restored by cycling the battery a number of times, but a restored battery will never reach the capacity of a new one.

If you must store your counter for some time without using it, store it in a cool and dry place. Leave the counter with the mains cable connected if possible. If not, don't disconnect the mains cable until the battery is fully charged, then charge the battery for at least 8 hours every 3 months.

CAUTION: Prolonged storage or use of the counter at temperatures above +40°C shortens the life of the battery.

The battery will freeze if it is not sufficiently charged when stored at a low temperature. 75% charge is sufficient for -40°C.

Error Codes

The counter can display the following error codes if something goes wrong.

Error OF	Overflow in the counting registers. Select a shorter Measuring-time if you get this error code, unless the counter is set to TOTALIZE, then you must press reset and start again from zero.
Error 01	RAM memory error
Error 02	Measuring logic error
Error 03	Internal bus error

If the counter shows one of these error codes, try switching the counter off and on again. If error code 01-03 persists, call Fluke service. Look on the last page in this manual for Phone No. and address.

GPIB-INTERFACE OPERATION

Introduction

The PM 6669 can be controlled by a computer (controller) via the GPIB-interface option, PM 9604. All functions that can be controlled from the front panel can also be controlled via the bus in a similar way, except selection of measuring functions $FREQ A/A_0$, and $FREQ A-A_0$, the filter, the sensitivity controls, and the power switch. The additional micro-processor on the interface board has made it possible to add functions. You can obtain continuously variable Measuring-time, bus-learn, high-speed-dump etc., but these functions are only accessible via the bus.

To select a function, you send a command to the counter. We have chosen the text on the front panel as commands, wherever possible, in order to make them easy to remember. E.g. the command to select Frequency-B is $FREQ B$ and the command to select Period A is $PER A$.

NOTE: The characters in a command can be in both upper and lower case.

What Can I Do Using the Bus?

All the capabilities of the interface for the PM 6669 are explained below. If you want a complete description of all GPIB-interface functions, read the 'Fluke Instrumentation-Systems Reference-Manual'.

Summary

Description	Code
Source handshake	SH1
Acceptor handshake	AH1
Control function	CØ
Talker Function	T5
Listener function	L4
Service request	SR1

Description	Code
Remote/local function	RL1
Parallel poll	PPØ
Device clear function	DC1
Device trigger function	DT1
Bus drivers	E2

Source and Acceptor Handshake SH1, AH1

SH1 and AH1 simply means that the counter can exchange data with other instruments or a controller, using the bus handshake lines; DAV, NRFD, NADC.

Control Function, CØ

The counter does not function as a controller.

Talker Function, T5

The counter can send responses and the results of its measurements to other devices or to the controller. T5 means that it has the following functions:

- Basic talker.
- Talk only mode.
- It can send out a status byte as response to a serial poll from the controller.
- Automatic un-addressing as talker when it is addressed as a listener.

Listener Function, L4

The counter can receive programming instructions from the controller. L4 means the following functions:

- Basic listener.
- No listen only.
- Automatic un-addressing as listener when addressed as a talker.

Service Request, SR1

The counter can call for attention from the controller e.g. when a measurement is completed and a result is available.

Remote/Local, RL1

You can control the counter manually (locally) from the front panel, or remotely from the controller. The LLO, local-lock-out function, can disable the LOCAL button on the front panel.

Parallel Poll, PP0

The counter does not have any parallel poll facility.

Device Clear, DC1

The controller can reset the counter, forcing it to default settings, via interface message DCL (Device clear) or SDC (Selective Device Clear).

Device Trigger, DT1

You can start a new measurement from the controller via interface message GET (Group Execute Trigger).

Bus Drivers, E2

The GPIB interface has tri-state bus drivers.

Connecting the Controller

The bus interface connector is on the rear panel of the counter. If your counter does not have any connector, you must install the GPIB-interface option.

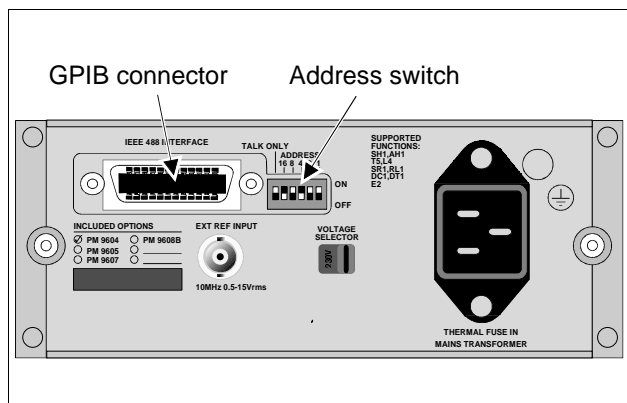

Figure 8 GPIB connector and address switch, the numbers above the switches indicate the significance of each switch.

Connect the controller via an IEEE-488 cable to the bus connector. If you use IEC-625 cables, an adapter is available, see ordering information at the end of this manual.

Giving the Counter an Address

The counter must have a unique address so that the controller can communicate with it. The address is selected by setting switches to the binary equivalent of the address you want. The switches are located to the right of the interface connector. The OFF position means 0 and the ON position means 1.

Ad- dress	Switch settings	Ad- dress	Switch settings	Ad- dress	Switch settings
0	00000	10*	01010	20	10100
1	00001	11	01011	21	10101
2	00010	12	01100	22	10110
3	00011	13	01101	23	10111
4	00100	14	01110	24	11000
5	00101	15	01111	25	11001
6	00110	16	10000	26	11010
7	00111	17	10001	27	11011
8	01000	18	10010	28	11100
9	01001	19	10011	29	11101
				30	11110

* Factory setting.

NOTE: 31 is the bus command for "Untalk" and should not be used. If 31 is selected the counter will work as if address 0 is selected.

Talk-Only

The leftmost switch in the address switch block is the TALK ONLY switch. If you set it to '1', the counter will output measurement results on the bus continuously. It will not react to any incoming commands.

This setting may only be used if the counter is connected to a 'Listen only' device such as a printer. Set the switch to '0' when you want normal bus communication.

Talk only is set to '0' on delivery.

The counter is now ready for bus control.

Checking the Communication

To check if the counter and the controller can communicate, address the counter and execute the following sequence: (The programming example is for an HP-85 controller.)

Type on Controller:	This Should Happen.
REMOTE 710	The remote indicator should be switched on.
OUTPUT 710;"ID?"	Ask for the counter identity.
ENTER 710;A\$	Input result from counter.
DISP A\$	The response on the display of the controller is the identity of the counter.

If everything is OK, the counter will identify itself as:

PM6669/YZW/MN

where:

- Y = 4 if the counter has an HF-input, otherwise 0.
- Z = 3 for MTCXO, otherwise 1
- W = 6 (GPIB-bus is installed)
- M = Revision No. of counter firmware
- N = Revision No. of GPIB-bus firmware

Two Ways of Programming

The simplest way of programming the counter is by manually setting up the measurement you want from the front panel of the counter, then let the controller ask the counter how it is set up. The data the controller gets from the counter can be used to set up the same measurement over and over again. This method is called 'Bus-learn' and will be explained later.

The other method is to make a program message where each step of the set-up is separately specified.

Programming Check-List

Check that the following steps have been taken to ensure correct programming of the instrument.

Normally only the six first steps must be programmed.

- Do you know the current setting of the counter? If not, send device clear 'D' to get the default settings.
- Select Measuring-function;
(Default: Frequency-A.)
- Select Measuring-time;
(Default: 0.2 s.)
- Select Trigger-level offset;
(Default: Positive)

For advanced programming, check the following steps.

- Select Trigger-slopes;
(Default: AUTO)
- Set Output separator;
(Default: LF.)
- Set EOI mode;
(Default: OFF.)
- Set service request(SRQ) -mask;
(Default, No SRQ.)
- Select Free-Run on or off;
(Default: ON.)
- If Free-Run is off, select Time-Out if desired;
(Default: Infinite, programmed as 0 s.)
- Set Output-mode;
(Default: Normal output format, High-speed dump OFF and MTCXO compensation ON.)

All functions and commands in the checklist will be explained later.

NOTE: You only have to program the changes from the previous set-up.

Syntax

What is a Programming Command?

A programming command consists of a header, addressing the function you want, and a body instructing the function what to do.

EXAMPLE:

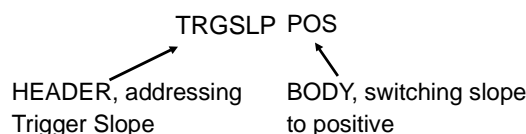

NOTE: Some programming commands consists only of the Header, e.g. trigger command 'X'.

What is a Programming Message?

A programming message is a number of programming commands with separators between them. E.g. the commands necessary to set up a measurement.

EXAMPLE: PER A;MTIME 0

Input Separator

All communication between the counter and the controller uses sequences of ASCII-characters terminated by a separator. Input separators are the separators sent by the controller. They are used in four different places:

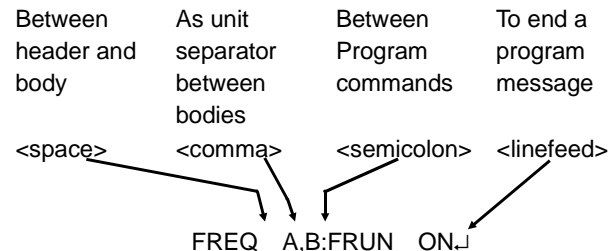

The separators in the example above are the ones normally used in respective place. The counter will however accept any one in any place.

The following separators will also work in any of the four places: colon, CR, ETB, ETX, the separator selected as output separator, as well as an active EOI-signal.

Order of Commands in a Program Message

Normally, the programming commands in a programming message can be placed in any order.

However, the following commands must always be placed at the end of a program message since any command sent after them will disable the selection:

```
INPA?      MEAC?      FNC?      X
BUS?      ID?        OUTM 4
```

These commands will be ignored if found anywhere but in the end of a message.

<number>

In some program commands, the body is replaced by the term <number> or <num>. Here you must enter a numerical value. <number> can be entered in any format you like e.g. 1.23 can also be entered as 0.000000123×10^7 or 1230000×10^{-6} . If you enter more digits than the counter needs, your entry will be truncated. The counter will stop if an entry is out of the counters range. To proceed, the status message 'Programming error' must be reset, see 'Status byte'.

Selecting Output Separator

Output separators terminate messages from the counter to the controller. The separator needed is different for different controllers; see the Operators' Manual for your controller.

At power on, the output separator of the counter is line-feed 'LF' (10_{decimal}).

The output separator can be changed by sending SPR <number> to the counter. <number> is the decimal value of the ISO (ASCII)-code for the desired separator. It can be 0-26, 28-31, ESC code, 27, is not accepted.

Only one <number> can be entered as separator. If you want the combination of CR+LF (13_{dec} + 10_{dec}), it is selected by 'SPR 255'.

EXAMPLE:

SPR 13 changes the output separator to CR

SPR 255 changes the output separator to CR+LF

The counter can signal EOI together with the last output separator in responses and output data.

EOI ON switches on the function.

EOI OFF switches it off.

Default setting is EOI OFF.

The selected separator and EOI will not be altered by LOCAL from the front panel nor by LOCAL or 'Device clear' from the bus.

How to Select Function

Standard Functions

Functions are selected by sending the appropriate function command to the counter, e.g. FREQ A. The space between FREQ and A indicates the input separator that you always must insert.

Function	Command	Comment
Frequency A	FREQ A	Default
Frequency B*	FREQ B	
Frequency A/A ₀	—	Make a FREQ A measurement and then perform the ratio calculation in the controller.
Frequency A-A ₀	—	Make a FREQ A measurement and then calculate the frequency difference in the controller.
RPM A	RPM A	
Period A	PER A	
Totalize A		
Manually	TOTM A	See 'Totalize start/stop'.
Pulse-width A	WIDTH A	The counter will also accept PWIDTH A.

The function cursor on the display of the counter will jump to the selected function.

*Only possible if Input-B option, PM 9608B is installed.

Selecting Measuring-Time



The Measuring-time can be set to any value between 10 ms and 10 s, or SINGLE-measuring. Any value below 10 ms will be interpreted as SINGLE. Values above 10 s will be out of range and cause an error. The program command is MTIME <number>. Always enter the Measuring-time in seconds. The entered value will be truncated to the nearest 10 ms increment.

Meas Time.	Command	Comment
0.2 s	MTIME 0.2	Default
10 ms	MTIME 0.01	You will not be able to see the gate indicator blinking if the Measuring-time is below 50 ms
7.34567 s	MTIME 7.34567	The Measuring-time will be 7.34 s.
2 ms	MTIME 0.002	Out of range. Measuring time will be SINGLE.
SINGLE	MTIME 0	A display time of 50 ms is set so that you can see the Gate-indicator.
25 s	MTIME 25.0	Out of range and error, the counter will stop. It can indicate programming error by sending an SRQ if selected in the SRQ-mask.

The Measuring-time cursor on the display will indicate 0.2 s for all programmed Measuring-times except SINGLE, which will be indicated as usual.

Selecting Triggering

The trigger level can be selected in the same way as from the front panel.

Trigger-level offset	Code	Comment
Auto	TLO AUT	Default
	TLO POS	
	TLO SYM	
	TLO NEG	

The trigger-level cursor on the front panel will indicate the setting.

Trigger slope	Command	Comment
Positive	TRGSLP POS	Default
Negative	TRGSLP NEG	Negative slope is only available via the bus and is used when you want to measure the negative Pulse-width.

When the counter switches to local, the trigger slope will switch back to positive. Trigger slope is not indicated on the display.

Totalize Start/Stop

When TOT A is selected, the gate is opened and closed by the controller instead of by pressing the button on the front panel. To start the counting after selecting TOTM A, the gate must be opened.

Totalize	Command	Comment
Start	GATE OPEN	Starts counting.
Stop	GATE CLOSE	Stops counting. Default.

NOTE: Multiple GATE OPEN/GATE CLOSE will accumulate the results in the counting registers. Any other command but GATE OPEN/GATE CLOSE will stop the totalizing and reset the counting registers to zero.

Free-Run/Triggered

The counter can work in two different ways:

- Free-Run**, where it starts a new measurement as soon as the previous measurement is finished. The first measuring result that is ready after the counter receives a read command, will be sent to the controller. When the result has been read, the output buffer is reset to zero until a new result is ready. One and the same measuring result can only be read once.
- Triggered**, where the counter waits for trigger command GET or 'X' from the controller before it starts a measurement. When the measurement is completed, the counter will wait until the controller reads the measuring results, then the output buffer is reset. The function is the same as when Displ Hold is selected from the front panel and you start a new measurement by pressing the reset button.

Free-Run	Command	Comment
Off	FRUN OFF	This function is sometimes called Triggered-Mode, so the TRIG ON command will also result in the same function.
On	FRUN ON	TRIG OFF gives the same result. Default.

Free-Run ON or OFF will not be indicated on the display. When the counter switches to LOCAL, Free-Run will always be ON but when the counter switches back to remote, it will return to its previously programmed settings.

Time-Out

When Free-Run is switched off it is possible to set a time-limit (time-out) between the start of a measurement and the time when a result is expected to be ready. If no result is achieved before the set time is out, the counter can output a Service Request, SRQ. Time-Out must be selected in the SRQ-mask; see 'Service Request'. The programming command is TOUT <number>. The timeout can be set to any value between 100 ms and 25.5 s, the minimum increment is 100 ms.

Time-Out	Command	Comment
100 ms	TOUT 0.1	Time-Out is only intended to be used with Free-Run off*.
Off	TOUT 0	Always send this command when Free-Run is switched on. Default.

Time-Out is not indicated on the display. When the counter switches to LOCAL, Time-Out is off, but when switched to remote again, the set Time-Out will be active again.

* Time-out can be switched on when free-run is on but it will not serve any purpose.

Bus Triggering

'X' will always cause the counter to start a new measurement. X will work as group execute trigger, GET. 'X' must always be placed in the end of a program message.

Service Request

The counter can send a service request, SRQ, when it wants service from the controller. After an SRQ, the controller must execute a serial poll which means that it must ask each of the instruments for status information until it finds the SRQ-giving instrument, evaluate the Status-byte of the instrument and then make a decision what to do.

To enable the counter to send service requests, you must set an SRQ-mask telling the instrument which conditions will cause SRQ.

Command	Comment
MSR <number>	<number> is a decimal value depending on selected SRQ reasons.

Bit	Decimal value	Reason for SRQ
7	128	Not used.
6	64	Time-Out.
5	32	Hardware fault.
4	16	Programming error.
3	8	Measuring stop enable.
2	4	Measuring start enable.
1	2	Ready for triggering.
0	1	Measuring result ready*.

* If SRQ for Measuring result ready is selected, the counter will stop and wait until the controller fetches the result before a new measurement can start.

Write down the binary word for the required SRQ, then convert it to a decimal value and insert the value as <number>.

EXAMPLE: If you want SRQ to be sent when the time-out elapses, when the counter is ready for triggering and when the result is ready, the binary word required is 01000011 which is decimal 67; see table below.

Bit	Value if the bit is 1	Example		
		Binary word	Decimal value	
7	128	0	0	
6	64	1	64	Time-Out
5	32	0	0	
4	16	0	0	
3	8	0	0	
2	4	0	0	
1	2	1	2	Ready to trigger
0	1	1	1	Meas. result ready
				+
				67

Send MSR 67 to the counter.

Status Byte

The counter sends its status byte to the controller on a serial poll. The bits in the status byte reflects different events or conditions in the counter. There are two types of status bits:

A conditional bit indicates the current condition of what its monitoring, all the time.

An event bit indicate that an event has occurred. When the event occurs, the bit is set to 1. It is not reset to 0 until a new measurement starts.

The different bits indicate the following information:

Bit	Function	
7	Always 0	
6	1 = SRQ has been sent*, otherwise 0 (Event bit).	
5	Abnormal bit. Always 0 during normal measurements, 1 if something is wrong. Affects bit 0-3, see below (Event bits.)	
4	0 = Main Gate closed, 1 = Main Gate open**	
3-0	Depends on Abnormal bit, see below (Event bits.)	
Bit	Abnormal bit = 1	Abnormal bit = 0
3	Not Used	Measuring stop enable.
2	Time-Out	Measuring start enable.
1	Hardware fault	Ready for triggering
0	Programing error	Measuring result ready.

* Only if SRQ-mask is set for Service-Request.

** This is a conditional bit that monitors the Main-Gate in the counter. When TOT MAN is selected the bit will always be 0.

Measuring start enable indicates that the counter logic is ready to start a measurement.

Measuring stop enable indicates that the counter logic is ready to stop a measurement.

These bits can be used to detect if the input signal to the counter is present; If the counter never stops its measurement and the status byte stops at:

XX00X1XX	No input signal. The measurement is ready to start (bit 2 = 1) but the Main Gate has not opened (bit 4 = 0).
XX011XXX	Input signal lost during measurement. The measurement is ready to stop (bit 3 = 1) but the main gate is still open (bit 4 = 1)

(X = don't care)

NOTE: SRQ is normally not used for these bits.

Ready for triggering indicates that all preparations for a measurement is completed. The preparation time depends on selected functions. It can be up to 700 ms (when auto triggering is selected).

If triggered mode is selected, the counter waits to be triggered, otherwise it proceeds with the measurement. You can have the SRQ-mask set for SRQ at ready for trigger-

ing. This way the controller knows when it is possible to trigger the counter.

Measuring result ready indicates that the measurement and calculation of the result is completed and that the result is present in the output buffer. If SRQ for is selected for this event, or Free-run is OFF, the counting will stop until the controller has read the result.

Programming error is generated if the counter receives messages with illegal syntax or values out of its range.

If 'Programming error' is generated, the counter will stop measuring. It will continue to receive and store correct programming messages and use them when the error status is reset and a new measurement starts.

Correct the program before resetting the status message.

Use one of the following bus commands to reset the status byte:

Go to local (GTL), Device clear (DCL) or selective device clear (SDC).

Any of the following messages will have the same effect on the counter:

D, FNC?, MEAC?, INPA?, ID? or BUS?.

A serial poll will also reset the status message if the SRQ mask is set for 'SRQ at Programming error'.

Hardware fault is generated when the counter displays the codes described in 'Error codes' in the 'Operating instructions' in this manual.

Time-Out is generated when the set time-out period has elapsed.

Possible Status Messages

Normal Measurement

The status byte changes as follows during a normal measurement:

0, 2, 6, 22, 30, 14, 15, 0,

Deci- mal*	Binary 76543210	Important bits (X = don't care)	Comment
0	00000000		Preparing a measurement or, High-speed dump or Volt measurements in progress.
2	00000010	XX0XXX1X	Preparations ready. If Free-run OFF

Deci- mal*	Binary 76543210	Important bits (X = don't care)	Comment
6	00000110	XX0XX1XX	Measuring start enable.
22	00010110	XX01XXXX	Main-Gate open
30	00011110	XX0X1XXX	Measuring stop enable.
14	00001110		Calculating the measuring result.
15	00001111	XX0XXXX1	Measuring result ready.

Error Conditions

Deci- mal*	Binary 76543210	Important bits (X = don't care)	Comment
33	00100001	XX1XXXX1	Programming error.
34	00100010	XX1XXX1X	Hardware fault.
36	00100100	XX1XX1XX	Time-out.

* If Service request (SRQ) is enabled for an event, the decimal value of the status message for that event will be increased by 64. The reason for this is that bit 6 will be set to one at the same time as the bit indicating the event.

Output Mode

Setting the output mode selects the format in which the counter will output measuring results to the controller. Select output mode by sending OUTM <number> where <number> is a decimal value between 0 and 4 depending on the selected output mode.

<number>	High-speed dump	Output format	MTCXO compensation
0	OFF	NORMAL	ON
1	OFF	SHORT	ON
2	OFF	NORMAL	OFF
3	OFF	SHORT	OFF
4	ON	FOR HIGH SPEED DUMP	OFF **

Default <number> is 0, when switching to local and back again, the <number> will be reset to 0.

The MTCXO compensation can be switched off to increase the measuring speed, providing a result with five digits accuracy is sufficient. The time gained will be up to 400 ms/measurement.

** Must be in the end of a program message.

Output Format

Normal

When you select normal output format, the output will be as follows:

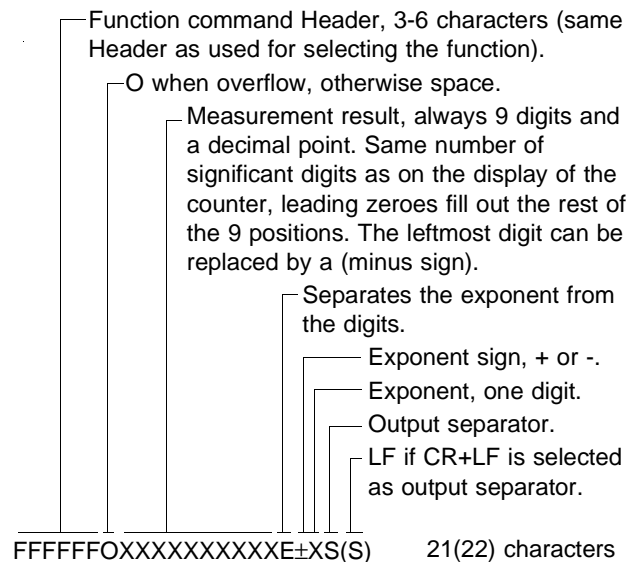

EXAMPLE:

Normal operation:

PER 000001.667E-4

Overflow:

PER O9.9999999E+9

Short

Short format means that function command and leading zeros are not sent to the controller. When you select short output format, the number of digits may vary depending on the measurement result. The example below shows a result with five significant digits:

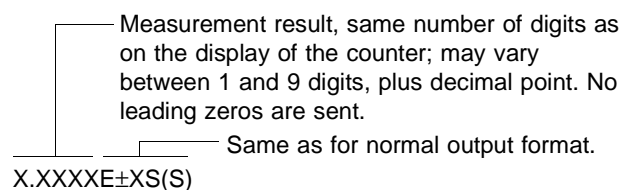

EXAMPLE:

Normal operation:

1.667E-4

Overflow:

9.9999999E+9

High-Speed Dump

The most time-consuming part of a measuring cycle is calculating the result. The calculations limit the number of possible results/second to about 5, even when the Measuring-time is short.

When however High-Speed dump is selected all calculations are left to the controller instead, and the counter can concentrate on measuring at a rate of over 100 measurements/second.

High-speed dump cannot be used for voltage measurements nor for Totalize manually. MTCXO compensation is not possible.

Starting

NOTE: Always make sure you have input signal and that the input triggers correctly before turning on high-speed dump! (See stopping below.)

If triggered mode is OFF

When High-speed dump is programmed the counter will immediately start transmitting results, so the OUTM 4 command must always be placed at the end of the program message.

If triggered mode is ON

After receiving OUTM 4 the counter waits for bus command GET before it starts.

NOTE: The minimum time between OUTM 4 and GET is 70 ms.

Stopping

Any programming command from the controller will end High-Speed dump. High-speed dump is stopped in-between two measurements. If you switch on high speed dump without having an input signal, the counter must be switched off/on to regain control over the counter.

NOTE: The Power-switch is the only front panel control that will stop High-Speed dump, the LOCAL-key will not have any effect.

Output Format

The output format will always be two letters followed by 12 hexadecimal digits. The two letters will tell the controller how to evaluate the twelve hex-digits, which represent the contents in the internal registers of the counter.

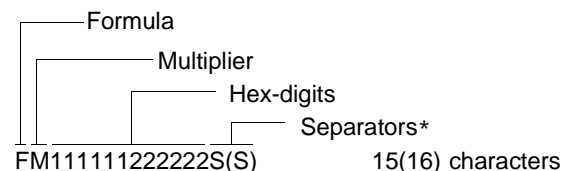

* The counter cannot signal EOI together with the output separator when High-speed dump is selected.

Hex-Digits

All 12 digits together represent register 3.

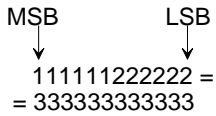

When the digits are divided into two groups, the first six digits represents register 1 and the last six digits represent register 2.



Formula

Depending on the selected measuring function different calculations must be made to convert the register contents to readable measuring results.

The first letter (F) in the output data indicates which formula you must use.

If 'F' =	Use this formula
C	$\frac{Reg. 2 * 10^7}{Reg. 1}$
F	Reg. 3
G	$\frac{Reg. 2}{Reg. 1}$
I	$\frac{Reg. 1 * 10^{-7}}{Reg. 2}$
J	$Reg. 3 * 10^{-7}$
K	$\frac{Reg. 2 * 10^{-7}}{Reg. 1}$

Multiplier

The second letter (M) in the output data represents a multiplier which you must multiply the results by before presenting it.

If 'M' =	Multiply results by:
H	60
L	256
N	0.1
O	10
P	1

EXAMPLE 1:

The following HP-85 program sets up a High-Speed dump Single-period measurement.

```

OUTPUT 710;"PER A,MTIME 0"
ENTER 710;A$
    
```

```

A$
PER 000001.667E-4
    
```

```

OUTPUT 710;OUTM 4
ENTER 710;A$
    
```

```

A$
JP000000000683
    
```

'J' means that you must use formula J which is:

$$Reg. 3 * 10^{-7}$$

00000000683 is the hex-contents of register 3. The register contents must be converted to a decimal number and entered in the formula;

$$683_{Hex} = 6 * 16^2 + 8 * 16 + 3 = 1667_{decimal}$$

The result is $1667 * 10^{-7}$. which you must multiply by "Multiplier P", which is 1, to get the measuring result.

$$1667 * 10^{-7} * 1 = 1.667 * 10^{-4} s = 166.7 \mu s$$

EXAMPLE 2:

The following HP-85 program sets up a High-Speed dump Frequency A measurement with 1 s Measuring-time.

```

OUTPUT 710;"FREQ A,MTIME 1"
ENTER 710;A$
    
```

```

A$
FREQ 006.000006E3
    
```

```

OUTPUT 710;OUTM 4
ENTER 710;A$
    
```

```

A$
CO98555B000257
    
```

Formula 'C' is: $\frac{Reg. 2 * 10^7}{Reg. 1}$

98555B is the hex-contents of register 1, and 000257 is the hex-contents of register 2. Both register contents must be converted to decimal numbers and put into the formula;

$$\frac{(2 * 16^2 + 5 * 16 + 7) * 10^7}{9 * 16^5 + 8 * 16^4 + 5 * 16^3 + 5 * 16^2 + 5 * 16 + 11} = 600.0006209..$$

This number is multiplied by multiplier 'O' to get the measuring result:

$$600.0006209 * 10 = 6000.006209 = 6.000006209 * 10^3 Hz$$

How Many Digits are Significant?

Select the formula for 'LSD displayed' in the 'Specifications'. There are different formulas for different measurements.

Frequency:

$$LSD_{displayed} = \frac{2.5 * 10^{-7} * FREQ}{Measuring-time}$$

$$LSD_{displayed} = \frac{2.5 * 10^{-7} * 6000....}{1} = 0.0015$$

LSD = 0.001 Hz

The result is $6.000006 * 10^3 Hz$

Bus Learn

- Set the counter to LOCAL and select the functions you want from the front panel.
- If required, set the counter to Remote and program special bus-functions from the controller.
- Check that the counter/controller performs the intended functions.
- If it does, send the five queries from the controller to the counter and store the responses in the controller for later use.

These are the five queries:

Query	Response	Max No. of Characters
FNC?	Functions setting; e.g. FREQ A	9
MEAC?	Measurement control; MTIME <number>,FRUN ON TOUT <number>	20 9
INPA?	Input-A settings; TRGSLP POS	10
BUS?	Bus interface commands; MSR <number>,OUTM <number> EOI OFF,SPR <number>	16 15

As you can see, the responses are the same commands as you use for normal programming. So if you have to change anything in a program made using bus learn, or add functions which are not selectable from the front panel, these program messages can easily be edited in the controller.

NOTE: MEAC? and BUS? result in a response sent as two lines, each terminated by the selected separator.

NOTE: The counter will stop measuring until all lines of the response have been read or the response has been terminated.

NOTE: The query command must always be the last command in a program message.

Terminating a Response

It is not necessary to read all output lines. Any program message will terminate the response.

Programming Data Out

Any one of the queries used for Bus Learn can be used to ask the counter about its current setting, see 'Bus Learn' above.

What Happens When I Switch to Local?

Switching to LOCAL causes the counter to adapt the settings indicated on the display, see 'How to select function'. This means that the counter will never have settings in LOCAL which are not possible to set via the front panel.

When switching to remote again, the LOCAL-setting will remain. Bus-functions like SRQ mask, output separator, EOI, etc. will not be altered by switching to LOCAL and back again.

Summary of Bus Commands

Function Selecting Commands

FREQ A	Frequency measurement on Input-A.
FREQ B	Frequency measurement on Input-B.
RPM A	Revolutions/minute on Input-A.
PER A	Period on Input-A.
WIDTH A	Pulse width on Input-A.
PWIDTH A	Pulse width on Input-A.
TOTM A	Totalize A, start/stop by GATE OPEN/CLOSED on the bus.
FNC?	Output the current function setting.*

Input Setting Commands

TLO AUT	Auto trigger level.
TLO POS	Positive trigger level offset \llcorner
TLO SYM	No trigger level offset \lrcorner
TLO NEG	Negative trigger level offset \lrcorner
TRGSLP POS	Triggering on positive slope.
TRGSLP NEG	Triggering on negative slope.
INPA?	Output the current Input-A settings.*

Measurement Control Commands

GATE OPEN	Starts the totalizing in TOTM A.
GATE CLOSE	Stops totalizing.
MTIME <num>	Set Measuring-time. <num> = 0.01-10 s. 0 = SINGLE
FRUN ON	Selects Free-Run.
FRUN OFF	Selects Triggered mode.
TRIG OFF	Selects Free-Run.
TRIG ON	Selects Triggered mode.
TOUT <num>	Sets Time-Out. <num> = 0.1 - 25.5 s. 0 = Time-Out OFF.
MEAC?	Output the current Measurement control settings.*

Bus Related Commands

OUTM <number>

<number>	High-speed dump	Output format	MTCXO compensation
0	OFF	NORMAL	ON
1	OFF	SHORT	ON
2	OFF	NORMAL	OFF
3	OFF	SHORT	OFF
4	ON	FOR HIGH SPEED DUMP	OFF*

MSR <num>	Sets SRQ-mask, see 'Service request'.
EOI ON	Selects EOI-mode ON.
EOI OFF	Selects EOI-mode OFF.
SPR <num>	Select output separator, see 'Output separators'.
X	Device trigger, starts a new measurement.*
D	Device clear, returns to default settings.
BUS?	Output the current bus related settings.*
ID?	Output identity and which options are installed.*

* This command must be placed at the end of a program message.

Programming Examples

For HP-85 Controller

This program illustrate high measuring rate obtained with High-speed dump.

The actual measuring function is selected by the user in Local-mode. When the program runs, two beep's can be heard from the HP-85, Between these beep's, the counter performs 500 measurements and the result of each measurement is transferred from the counter to the HP-85.

The output rate is approximately 125 readings/second in this example.

```

10 ! DEMO PROGRAM DUMP MODE
20 ! PM6669 WITH HP85 AS
30 ! CONTROLLER
40 ! DUMP MODE WITH FREE RUN ON
50 CLEAR
60 DIM Z$(7508) ! BUFFER FOR 500
  MEASUREMENTS WITH 15 BYTES
70 DIM B$(14)
80 IOBUFFER Z$
90 LOCAL 710
100 DISP "SELECT FUNCTION IN LOCAL MODE!"
110 DISP "MEASURING TIME WILL BE"
120 DISP "SELECTED BY HP85 (SINGLE)!"
130 DISP "ANSWER Y WHEN READY TO START!"
140 INPUT A$
150 IF A$<>"Y" THEN 130
160 DISP "MAKE 500 MEASUREMENTS"
170 OUTPUT 710 ;"TRIG OFF,MTIME 0,OUTM 4"
180 BEEP
190 E=TIME
200 TRANSFER 710 TO Z$ FHS ; COUNT 7500
210 F=TIME
220 TIME
230 DISP "READY! ELAPSED TIME: ";F-E;"s"
240 ! SHOW 5 RESULTS"
250 DISP "FIRST 5 RESULTS:"
260 FOR K=1 TO 5
270 ENTER Z$ ; B$
280 ! GET FORMULA CHARACTER
290 F$=B$(1,1)
300 ! GET MULTIPLYER CHARACTER
310 M$=B$(2,2)
320 ! EVALUATE REGISTER 1
330 R1=0
340 FOR I=1 TO 8
350 S=NUM(B$(I,I))-48
360 IF S>=10 THEN S=S-7
370 R1=R1*16+S
380 NEXT I
390 ! EVALUATE REGISTER 2
400 R2=0
410 FOR I=9 TO 14
420 S=NUM(B$(I,I))-48
430 IF S>=10 THEN S=S-7
440 R1=R2*16+S
450 NEXT I
460 ! EVALUATE RESULT
470 IF F$="C" THEN R=10000000*R2/R1
480 IF F$="F" THEN R=R1*16^6+R2

```

```

490 IF F$="G" THEN R=R2/R1
500 IF F$="I" THEN R=.0000001*R1/R2
510 IF F$="J" THEN R=.0000001*(R1*16^6+R2)
520 IF F$="K" THEN R=.0000001*R2/R1
530 IF M$="H" THEN R=R*60
540 IF M$="L" THEN R=R*256
550 IF M$="N" THEN R=R/10
560 IF M$="O" THEN R=R*10
570 IF M$="P" THEN R=R*1
580 DISP B$,R
590 NEXT K
600 LOCAL 710
610 END

```

Example of a result:

```

MEASURING TIME WILL BE
SELECTED BY HP85 (SINGLE)!
ANSWER Y WHEN READY TO START!
?
Y
MAKE 500 MEASUREMENTS
READY! ELAPSED TIME: 3.931 S
FIRST 5 RESULTS:
JP0000000000031 .0000049
JP0000000000030 .0000048
JP0000000000031 .0000049
JP0000000000031 .0000049
JP0000000000031 .0000049
5053

```

For IBM PC with PM 2201

Example 1

The following example runs on an IBM compatible PC equipped with Fluke PM 2201 GPIB interface. The installation and starting up of the PC program is not described, only the application program. Line 1 to 100 must contain the declaration described in the PM 2201 manual.

The program sets up the counter for 10 Period A measurements and presents the average result on the screen.

```

100 'DEMO PROGRAM (NO 1)
110 'PM6669 AND IBM PC
120 'WITH PM2201 GPIB INTERFACE
130 'AS CONTROLLER
140 CLS 'CLEAR SCREEN
150 AD=7 'ADAPTOR NUMBER
160 ADDR=710 'COUNTER ADDRESS
170 SC=1 'SYSTEM CONTROLLER
180 RES$ = SPACE$(25) 'RESULT
190 ACT = 0 '# READ CHARACTERS IN RES$
200 MAX = 24 'MAX CHARACTERS TO READ IN
    RES$
210 CALL IOINIT(AD,SC) 'INIT INTERFACE
220 TIME=10 'TIMEOUT AFTER 10 SECONDS
230 CALL IOTIMEOUT (AD,TIME) 'SET TIMEOUT
240 CALL IOCLEAR(ADDR) 'SEND SDC
250 'SELECT PERIOD A, TRIGGERED MODE
260 'AND 1 S MEASURING-TIME
270 SEND$ = "PER A,TRIG ON,MTIME 1"
280 LENGTH=LEN(SEND$)
290 CALL IOOUTPUTS(ADDR,SEND$,LENGTH)
300 Z=0
310 'INPUT 10 SAMPLES
320 FOR i = 1 TO 10
330 CALL IOTRIGGER(ADDR) 'TRIGGER COUNTER
340 CALL IOENTERS(ADDR,RES$,MAX,ACT) 'READ
    RESULT
350 Z = Z + VAL(MID$(RES$,8,13))
360 NEXT I
370 PRINT "AVERAGE: ";Z/10;"S"
380 CALL IOLOCAL(ADDR) 'GO TO LOCAL
390 END
    
```

Example of a result:

```

AVERAGE:      9.98004E-06 S
OK
    
```

Example 2

This program example illustrates the 'program data out' feature of PM 6669. By asking a set of queries, the counter responds with its current setup. The output format of these answers to the queries is identical to the programming command format. The answers can be stored and used later for reprogramming (bus learn).

```

100 'DEMO PROGRAM
110 'PM6669 AND IBM PC WITH PM2201
120 GPIB INTERFACE AS CONTROLLER
130 AD=7 'ADAPTOR NUMBER
140 ADDR=710 'COUNTER ADDRESS
150 SC=1 'SYSTEM CONTROLLER
160 CALL IOINIT(AD,SC) 'INIT INTERFACE
    
```

```

170 TIME=10 'TIMEOUT AFTER 10 SECONDS
180 CALL IOTIMEOUT(AD,TIME)
190 CLS 'CLEAR SCREEN
200 ASK FOR AND PRINT PROGRAM DATA
210 PRINT "COUNTING SETTING:"
220 S$ = "FNC?"
230 GOSUB 520
240 A=1
250 GOSUB 550
260 S$ = "MEAC?"
270 GOSUB 520
280 A=2
290 GOSUB 550
300 S$ = "BUS?"
310 GOSUB 520
320 A=2
330 GOSUB 550
340 S$ = "INPA?"
350 PRINT "INPA:"
360 GOSUB 520
370 A=1
380 GOSUB 550
390 S$ = "INPB?"
400 PRINT "INPB:"
410 GOSUB 520
420 A=1
430 GOSUB 550
440 S$ = "ID?"
450 PRINT
460 PRINT "COUNTER TYPE:"
470 GOSUB 520
480 A=1
490 GOSUB 550
500 CALL IOLOCAL (ADDR) 'GO TO LOCAL
510 END
520 L=LEN(S$) 'LENGTH OF STRING TO SEND
530 CALL IOOUTPUTS(ADDR,S$,L) 'OUTPUT STRING
540 RETURN
550 FOR I = 1 TO A
560 MAX=25
570 ACT=0
580 RES$=SPACE$(25)
590 CALL IOENTERS(ADDR,RES$,MAX,ACT)
600 B$ = LEFT$(RES$,ACT)
610 PRINT B$;
620 NEXT I
630 RETURN
    
```

Example of a result:

```

COUNTER SETTING:
TIME A;B
MTIME1.00,FRUN ON
TOUT 00.0
MSR 000,OUTM 000
EIO OFF,SPR 010
INPA:
TRGSLP NEG
INPB:
TRGSLP POS
    
```

```

COUNTER TYPE:
PM6669/016/22
Ok
    
```

Example 3

This program prompts the user to input a programming sequence. The sequence is then sent to the PM 6669 and the corresponding measuring result is read.

Let us as an example select Single Period measurements, without AUTO-triggering (gives faster operation).

```

100 'DEMO PROGRAM
110 'PM6669 AND IBM PC WITH PM2201
120 'GPIB INTERFACE AS CONTROLLER
130 CLS 'CLEAR SCREEN
140 AD=7 'ADAPTOR NUMBER
150 ADDR=710 'COUNTER ADDRESS
160 SC=1 'SYSTEM CONTROLLER
170 CALL IOINIT(AD,SC) 'INIT INTERFACE
180 TIME=10 'TIMEOUT AFTER 10 SECONDS
190 CALL IOTIMEOUT (AD,TIME)
200 CALL IOCLEAR(ADDR) 'SEND SDC
210 PRINT "INPUT YOUR PROGRAMMING MESSAGE?"
220 PRINT "(TO QUIT THE PROGRAM, ANSWER *)"
230 LINE INPUT S$
240 L=LEN(S$) 'LENGTH OF STRING TO SEND
250 IF L<>1 GOTO 280
260 IF S$<>"*" GOTO 280
270 END
280 CALL IOOUTPUTS(ADDR,S$,L) 'OUTPUT STRING
290 'TO BE SURE, TRIGGER COUNTER!
300 CALL IOTRIGGER(ADDR)
310 'GET THE MEASURING RESULT
320 MAX=25
330 ACT=0
340 RES$=SPACE$(25)
350 CALL IOENTERS(ADDR,RES$,MAX,ACT)
360 PRINT
370 PRINT "RESULT READ AS: ";RES$
380 PRINT
390 GOTO 210

```

Example of a result:

```

INPUT YOUR PROGRAMMING MESSAGE?
(TO QUIT THE PROGRAM, ANSWER *)
PER A, MTIME 0

RESULT READ AS: PER 0000001.00E-5

INPUT YOUR PROGRAMMING MESSAGE?
(TO QUIT THE PROGRAM, ANSWER *)

```

For IBM PC with IBM GPIB

This example runs on an IBM PC with an 'IBM General Purpose Interface Bus Adapter' instead of the Fluke PM 2201 interface.

The following set of device parameters is suitable for a PM 6669 with address 10. The device parameters are set with the configuration program 'IBCONF', see the IBM adapter manual.

Device Name: COUNTER		DEVICE PARAMETERS		Number: D 0
DESCRIPTION	NEW VALUE	VALID NAME		
Access Adapter Name?	GPIB0	± [GPIBx]		
Primary GPIB Address?	0AH	[0H to 1EH]		
Secondary GPIB Address?	00H	[60H to 7EH: 0H disables]		
Timeout setting?	T10s	± [T10us to T1000s: TNONE disables]		
EOS Byte?	0AH	[0H to FFH or '<character>]		
Terminate Read on EOS?	Yes	± [Yes or No]		
Send EOI with EOS byte?	No	± [Yes or No]		
Use 8-bit Compare on EOS?	No	± [Yes or No]		
Send EOI w/last Byte of Write?	Yes	± [Yes or No]		

Example 1

The following program sets up the counter for 10 Period A measurements and presents the average result on the screen.

```

100 'DEMO PROGRAM
110 'PM6669 AND IBM PC WITH IBM
120 'GPIB ADAPTOR AS CONTROLLER
130 CLS 'CLEAR SCREEN
140 'INIT
150 ADNAME$ = "COUNTER"
160 CALL IBFIND(ADNAME$,CNT%)
170 'SEND SDC
180 CALL IBCLR(CNT%)
190 'SELECT PERIOD A, TRIGGERED MODE
200 'AND MEASURING TIME 1 S
210 WRT$ = "PER A,TRIG ON,MTIME 1"
220 CALL IBWRT (CNT%,WRT$)
230 'INPUT 10 SAMPLES
240 Z=0
250 FOR I= 1 TO 10
260 CALL IBTRG(CNT%) 'TRIGGER COUNTER
270 CALL IBRD(CNT%,RD$) 'READ RESULT STRING
280 Z = Z + VAL (MID$(RD$,8,13))
290 NEXT I
300 PRINT "AVERAGE: ";Z/10;"S"
310 CALL IBLOC(CNT%) 'GO TO LOCAL
320 END

```

Example of a result:

```

AVERAGE: 9.980422E-06 S
Ok

```

SPECIFICATIONS

Measuring Functions

Frequency A or B

Range,

Freq A: 0.1 Hz to 160 MHz

Freq B: 70 MHz to 1.3 GHz (option PM 9608B)

Mode: Reciprocal frequency counting.

LSD unit displayed: $\frac{2.5 * 10^{-7} * \text{FREQ}}{\text{Measuring time}}$

Frequency A/A₀

A Frequency A measurement is performed. The measured frequency is divided by the constant A₀ before display. The resolution of the displayed ratio is determined by the FREQ A measurement. At power on A₀ is set to 1 (default).

Frequency A-A₀

A Frequency A measurement is performed. The value of the constant A₀ is subtracted from the measured frequency before display. The resolution of the displayed difference is determined by the FREQ A measurement. At power on A₀ is set to 0 (default).

RPM A

A FREQUENCY A measurement is done. The measured frequency is multiplied with 60, and shown on the display as revolutions per minute (RPM).

Range: 6 RPM to 720*10⁶ RPM

Period A

Range: 8 ns to 2*10⁸s

Mode: Single period measurement (SINGLE) or period average measurement (at 0.2, 1 or 10 s Measuring-times).

LSD Displayed:

SINGLE period measurement: 100 ns (*TIME* < 100s)
 $\frac{5 * \text{PERIOD}}{10^9 \text{ s}}$ (*TIME* > 100s)

Period average measurement: $\frac{2.5 * 10^{-7} * \text{PERIOD}}{\text{Measuring time}}$

Totalize A

Event counting is controlled by the START/STOP button. Sequential start-stop counts are accumulated. RESET closes the gate and resets the Frequency Counter to zero.

Range: 0 to 1*10¹⁵ with indication of k or M (Kilo-pulses or Megapulses). The result is truncated if out of display range.

Frequency Range:

Sine-Wave: 0 Hz to 16 MHz

Pulse: 0 Hz to 16 MHz

Pulse Pair Resolution: 8 ns

LSD displayed: 1 unit count (counts < 10⁹)
 $5 * \text{counts} / 10^9$ (counts ≥ 10⁹)

Width A

A positive Pulse Width measurement is performed. Measuring time selection is not valid (always SINGLE measurement).

Range: 100 ns to 2 * 10⁸ s

LSD Displayed: 100 ns ($Time < 100$ s)

$$\frac{5 * WIDTH}{10^9 \text{ s}} \quad (Time > 100 \text{ s})$$

NOTE: Triggering on 50% of amplitude will occur only if the duty factor of the signal is 0.5.

Definitions

LSD Displayed LSD = Unit value of the least significant digit displayed. All calculated LSD:s (see section Measuring functions) should be rounded to the nearest decade (e.g 0.3 Hz is rounded to 0.1 Hz and 5 Hz to 10 Hz) and cannot exceed the 9th digit.

Resolution Resolution = smallest increment between two measuring results on the display, due to the 1 count error.

Freq A, B, and Period A: Resolution can be 1 LSD unit or 2 LSD units.

$$\text{If: } \frac{LSD * Measuringtime}{FREQ \text{ or } PERIOD} < 10^{-7}$$

the resolution is 2 LSD units (30% probability). Otherwise resolution is 1 LSD unit (70% probability).

SINGLE Period A and Width A: Resolution equals 1 LSD unit.

Inaccuracy Inaccuracy, i.e the relative error, depends on the following factors:

$$\frac{Resolution}{FREQ, PERIOD, \text{ or } WIDTH}$$

± relative trigger error

± relative time base error

Relative trigger error, Freq A, Period A:

$$\pm \frac{\text{noise voltage } A (V_{pp})}{\text{signal slope } A (V_s) * \text{meas time}}$$

Relative time base error: $\pm \frac{\text{deviation from 10 MHz}}{10 \text{ MHz}}$

Input specifications

Input-A

Frequency Range: 0 Hz to 160 MHz

Sensitivity,

Sine: 10 mV_{RMS} 10 Hz to 120 MHz
30 mV_{RMS} typically 120 MHz to 160 MHz

Pulse: 30 mV_{RMS} 0.1 Hz to 120 MHz

Coupling: AC

Impedance: 1 MΩ // 30 pF

Attenuation: Continuously variable in two ranges between x1 and x400.

Filter: Switchable 50 kHz low pass noise filter, on Input-A, with a suppression of 20 dB at 200 kHz.

Trigger Levels: Three different levels for triggering on signals with various duty factors, and AUTO.

 symmetrical input signals, should be selected for input signals with a duty factor of 0.25 to 0.75%.

 positive pulses, for input signals with duty factor <25%.

 negative pulses, for input signals with duty factor >75%.

AUTO Trigger Levels: The counter will make test settings and automatically selects the best trig level setting. AUTO requires repetitive signals with a repetition rate >100 Hz. AUTO is not active in TOTALIZE A measurements.

Trigger Slopes via GPIB Only: Positive or negative.

Maximum Voltage: 350 V (DC + AC_{peak}) between 0 and 440 Hz, falling to 11 V_{RMS} at 1 MHz.

Input-B

(option PM 9608B)

Frequency Range: 70 MHz to 1.3 GHz

Coupling: AC

Operating Input Voltage Range:

10 mV_{RMS} to 12 V_{RMS}, 70 MHz to 900 MHz

15 mV_{RMS} to 12 V_{RMS}, 900 MHz to 1.1 GHz

40 mV_{RMS} to 12 V_{RMS}, 1.1 to 1.3 GHz

AM Tolerance: 98%, minimum signal must exceed minimum operating input voltage requirement

Impedance: 50Ω nominal, VSWR <2:1

Maximum Voltage Without Damage: 12 V_{RMS}, overload protection with PIN diodes.

Ext Reference Input

The input automatically detects when a suitable external reference signal is connected. The use of an external reference signal is indicated on the display.

Input Frequency: 10 MHz ±0.1 MHz

Coupling: AC

Sensitivity: 500 mV_{RMS}

Input Impedance: approx. 300Ω at 10 MHz

Max Input Voltage: 15 V_{RMS}

General Information

Power Requirements

Line Voltage: 115 or 230 V_{RMS} 15%;
46 to 440 Hz, (<20 VA incl. all options).

Safety: in accordance with IEC publication 1010-1, and CSA 22.2 No.231.

Line Interference: below VDE 0871 B and MIL STD 461.

Battery Unit: See PM 9605 option.

Dimensions and Weight

Width: 186 mm

Height: 88 mm

Depth: 270 mm

Weight, net: 2.1 kg, shipping:3.0 kg

Cabinet: The counter is housed in a metal cabinet, to minimize electro-magnetic interference and achieve good mechanical stability.

Environmental Conditions

Temperature,

Operating: 0°C to +50°C

Storing: -40°C to +70°C

Altitude,

Operating: 5000 m (53.3 kN/m²)

Storing: 15000 m (15.2 kN/m²)

Humidity,

Operating: 10% to 90% RH, no condensation

Storing: 5% to 95% RH

Vibration Test: According to IEC 68Fc

Bump Test: According to IEC 68Eb

Handling Test: According to IEC 68Ec

Display

Read Out: 9 digit LCD display with unit indication.

Unit Indication: MHz, kHz, Hz, mHz, ks, s, ms, μs, ns, M, k, m, μ, and n.

GATE Indicator: Indicates that the counter is busy measuring.

REMOTE Indicator: Indicates when control over the counter is taken over by an installed GPIB interface PM 9604.

Cursor: Indicates selected measuring function, selected Measuring-time, input triggering, display hold and whether an external reference frequency is in use.

Time Base (Crystal Oscillator)

Choice of:

- Uncompensated crystal oscillator (order no PM 6669/.1.)
- MTCXO, i.e. Mathematically Temperature Compensated Crystal Oscillator (order no PM 6669/.3.). The MTCXO can be ordered separately for later upgrading of the counter (option PM 9607).

MTCXO Working Principle: The temperature of the crystal is measured. The built-in microprocessor calculates the frequency deviation for that particular temperature from a stored table. The measuring result is mathe-

matically corrected for the time-base frequency temperature error, before being displayed.

Oscillator Version:

	Uncompensated	MTCXO
Stability against:		
Ageing per month	$< 5 \cdot 10^{-7}$	$< 1 \cdot 10^{-7}$
per year	$< 5 \cdot 10^{-6}$	$< 5 \cdot 10^{-7}$
Temperature changes 0 to 50°C	$< 1 \cdot 10^{-5}$	$< 2 \cdot 10^{-7}$
Line voltage changes 10%	$< 1 \cdot 10^{-8}$	$< 1 \cdot 10^{-9}$

Auxiliary Functions

Power On/Off

Switches counter power on/off. At power up a self-test is made and the counter is set to default settings.

Default Settings,

Function: FREQ A

Measuring-Time: 0.2 s

Trigger-Level Offset: AUTO

Reset

The RESET-button has three functions:

RESET Starts a new measurement. The settings are not changed.

LOCAL Makes the counter go to LOCAL operation, when in remote operation (unless Local Lock-Out is programmed).

START/STOP Opens/closes the gate in TOTALIZE A or B manual mode.

Measuring-Time

A measuring-time of 0.2 s, 1 s, 10 s or SINGLE can be selected.

NOTE: When SINGLE is selected together with PERIOD, or WIDTH, the result is a single cycle measurement, but SINGLE together with FREQUENCY or RPM results in a fixed 3 ms Measuring-time.

Measuring Rate: Approx. 5 measurements/s.

Display Time: Normally the display time equals the set Measuring-time. When SINGLE is selected, a display time of 0.1 seconds is used.

Displ Hold/Store A₀

The DISPL HOLD/STORE A₀ button has two functions:

DISPL HOLD The result of the current measurement will be frozen on the display. A new measurement starts when RESET button is pressed.

STORE A₀ This function is active in FREQ A measurements only. When the button is pressed for > 1 s, the result on the display is stored as the constant A₀, which is used for the calculation of frequency difference (A-A₀) and ratio (A/A₀).

Blank Digits

This function blanks any number of least significant digits on the display, in order to hide unstable digits on the display.

Optional Accessories

GPIB-Interface, PM 9604

Mounting: Inside counter cabinet.

Interface Functions: SH1, AH1, T5, L4, SR1, RL1, DC1, DT1, E2

Address Setting: Switch selectable at rear panel between 0 and 30. Factory preset at 10.

Programmable Device Functions:

- Measuring functions
- Measuring-time
- Trigger slope
- Manual Totalize gate control
- Output separator selection
- Device clear
- Device trigger
- High-speed dump
- MTCXO on/off
- Short output format
- Free run/Triggered measurements
- Set SRQ-mask
- Program data out queries
- Device identity query

Programming Code Format: 7-bit ISO code (ASCII) characters. Both upper and lower case characters are accepted.

Input Separator: The counter accepts the following characters as separators:

ETX, ETB, CR, LF, ' '(space), ','(comma), ':'(colon), ';'(semicolon).

Output Data Separator: Default separator at power-on is LF. The separator can be programmed to be any non printable ASCII-code with decimal equivalent 0-31, except 27 (ESC).

In addition the combination 13+10 (CR+LF) can be programmed. The EOI-line can be programmed to be active together with the last output byte sent.

Output Format:
Measuring result is sent as:

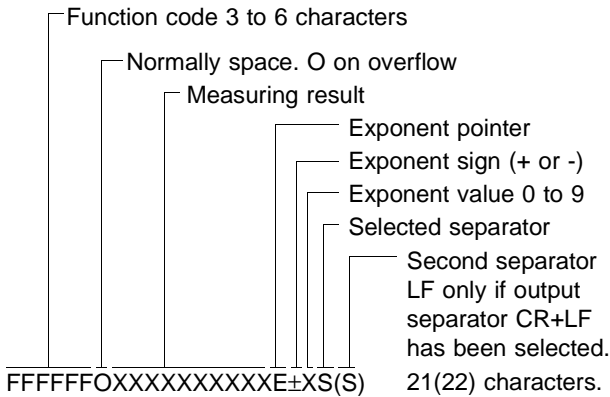

When you select 'Short output format' FFFFFFFF and leading zeroes are omitted.

High-Speed Dump

The contents of the counting registers are transferred to the controller, without being processed by the counter. The processing must be done in the controller instead. Max output rate is approximately 100 readings/s.

The output format is FMXXXXXXXXXXS(S) where F is calculation formula, M is multiplier, X..X = 12 hex-digits representing the register contents, and S(S) is the set output separator.

Ranges: Same as for normal operation, with the following exceptions:

Frequency; Max measuring time: 1 s

Period, Average; Max measuring time: 1.4 s

Time Interval, Average; 0 ns to 1.6 s
Max measuring time: 4 s

Ratio A/B: 0 and $6 \cdot 10^{-7}$ to $1.6 \cdot 10^8$

Ratio B/A: 0 and $6 \cdot 10^{-8}$ to $1.6 \cdot 10^7$

Ratio C/A, C/B: 8 to $4 \cdot 10^9$

Max Data Output Rate: Normal mode gives >5 readings/s. High-speed dump gives >100 readings/second.

The highest output rate is obtained at SINGLE Measuring-time.

Output Time for Measuring Data;

Normal operation: Approx. 10 ms (21 bytes)

High-speed dump: Approx. 4 ms (15 bytes)

Response time for addressing: Approx. 5 µs

Response Time for Trigger Command (GET):

Normal Operation: Approx. 10 ms

High-Speed Dump: Approx. 2 ms

Response Time for Serial Poll: Approx. 1.5 ms

Input Buffer Size: 28 bytes

Typical Read Time for Programming Data: Approx. 1 ms/byte (unless input buffer is full)

Battery Unit PM 9605

The PM 9605 is a rechargeable battery unit for mounting inside the counter. The unit contains a standard 6 V sealed lead-acid battery and an automatic battery charger.

Battery Capacity (20°C): Approx 15 Wh

Operating Time When Battery Powered: 3 hours of continuous operation.

Recharging Time: 7 hours to approx 75% of full capacity.

Battery Protection: Overcharge protection and auto-shut-off total discharge protection.

Temperature,

Operating: 0 to +40°C

Storage: -40 to +50°C

Weight: 0.8 kg

Rack Mounting Adapter, PM 9606/01

The PM 9606/01 is a 19" wide Rack Mounting Adapter. It can host one PM 6662, PM 6665, PM 6666 or PM 6669 Counter only.

Rack Mounting Adapter, PM 9606/02

The PM 9606/02 is a 19" wide Rack Mounting Adapter. It can host one PM 6662, PM 6665, PM 6666 or PM 6669 Counter together with a second instrument.

That second instrument can be a Philips PM 2534 to 35 or a FLUKE 8840 Digital Multimeter, or another PM 666X counter.

High Stability Time-Base PM 9607

See specifications for optional MTCXO time-base.

HF-Input PM 9608B

See specifications for optional Input-C.

Ordering Information

Versions

The PM 6669 ordering number consists of the basic type number and a 3 digit XYZ suffix, specifying the required con-figuration.

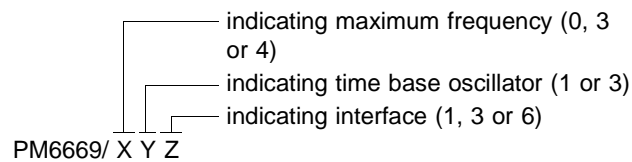

Type No.	Description
PM 6669/011	Frequency counter, 160 MHz frequency range, uncompensated oscillator $5 \cdot 10^{-7}$ /month, incl. operators manual.
PM 6669/4..	As above, but including 1.3 GHz HF-input PM 9608B.
PM 6669/.3.	As above, but including crystal oscillator PM 9607 (MTCXO).
PM 6669/..3	As above, but including battery unit PM 9605.
PM 6669/..6	As above, but including GPIB interface PM 9604.

Example: PM 6669/416 means a PM 6669 frequency counter, including both an 160 MHz and an 1.3 GHz input channel, an uncompensated oscillator and a GPIB interface.

Options and Accessories

PM 9604	GPIB-interface
PM 9605	Battery unit
PM 9606	Rack-mount kit
PM 9607	MTCXO time-base
PM 9608B	1.3 GHz HF-input
PM 9609	Carrying case
PM 2296/50	IEEE to IEC adapter
PM 2295/05	IEEE cable, 0.5 m
PM 2295/10	IEEE cable, 1 m
PM 2295/20	IEEE cable, 2 m
PM 8911	1.5 GHz, 500Ω probe set, 1:10
PM 8922	120 MHz, 1 MΩ probe set, 1:1 and 1:10
PM 8943	650 MHz, 1 MΩ FET probe set
PM 9581	50Ω termination, 3 W
PM 9585	50Ω termination, 1 W

All options mentioned above can be installed by the customer.

NOTE: The GPIB interface PM 9604 and the battery unit PM 9605 can not be installed together in a PM 6669 counter.

Manuals

4822 872 20021	Operators Manual
4822 872 20022	Operators Manual (German)
4822 872 20023	Operators Manual (French)
4822 872 25006	Service Manual
4822 872 20016	GPIB Pocket Guide

APPENDIX 1

Checking the Sensitivity of Counters

Introduction

The sensitivity of a counter is normally specified as the minimum signal voltage on which the input of the counter will trigger correctly.

When you use a signal-source with an output-impedance of 50Ω , constant-output-amplitude, and the counter has a 50Ω input-impedance, the input signal of the counter is in theory independent of the cable length. However, if the input impedance deviates from 50Ω there will be standing wave reflections which will cause changes in the amplitude of the signal between the signal-source and the counter input.

Two factors determine the magnitude of the changes, i.e. frequency and capacitive load.

EXAMPLE: For a $1\text{ M}\Omega/35\text{ pF}$ input, the 35 pF parallel capacitance is approximately equal to a 50Ω capacitive load at 100 MHz .

Consequently, it is of the utmost importance to know how sensitivity is measured.

Recommended Instruments

- Signal-source with a 50Ω output impedance.
- $>350\text{ MHz}$ oscilloscope with a 50Ω input impedance.
- BNC T-piece.
- Two BNC-cables, one short and one long.

High-Impedance Inputs ($1\text{ M}\Omega$)

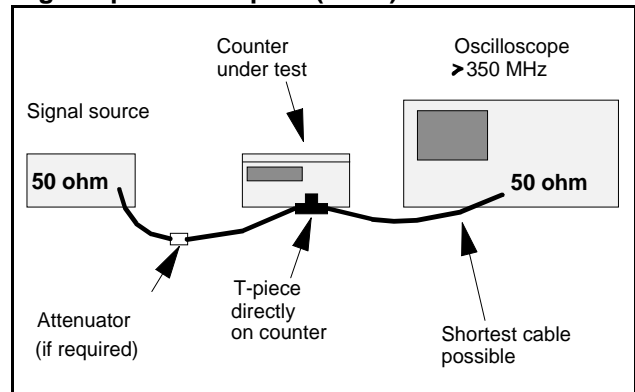

Preparations

Connect the instruments as illustrated in the figure above. Set the counter to maximum sensitivity.

Method 1

- Adjust the amplitude of the signal-source to the minimum level accepted by the counter.
- Read the amplitude on the oscilloscope.
- Check that the reading is the same as, or less than, the sensitivity level in the counter specifications.

Method 2

- Adjust the amplitude of the signal-source until the oscilloscope indicates the sensitivity limit in the counter specifications.
- Check that the counter is operating correctly.

Low-Impedance Inputs (50Ω)

If you have a calibrated signal-source

- Adjust the signal-source to the sensitivity limit of the counter.

- Connect it directly to the input of the counter.
- Check that the counter is operating correctly.

If you don't have a calibrated signal-source

Use either of the following methods

Method 1

- Connect the output of the signal-source directly to the input of the counter.
- Turn off AUTO and Set the counter to maximum sensitivity (if adjustable).
- Adjust the amplitude of the signal-source to the minimum level accepted by the counter.
- Disconnect the cable from the counter and connect it to the oscilloscope.
- Read the amplitude on the oscilloscope.

- Check that the reading is the same as, or less than, the sensitivity level in the counter specifications.

Method 2

- Connect the signal-source to the oscilloscope.
- Adjust the output amplitude of the signal-source until the oscilloscope indicates the sensitivity limit in the counter specifications.
- Disconnect the cable from the oscilloscope and connect it to the counter.
- Set the counter to maximum sensitivity (if adjustable).
- Check that the counter is operating correctly.

These procedures ensure unambiguous measurements of the signal voltage at the input of the counter.

INDEX

- A**
- Abnormal bit
 - See Status byte
 - AC
 - Selecting..... 18
 - Accessories..... 40
 - Address 22
- B**
- Battery unit
 - Operation..... 20
 - Preventive maintenance 20
 - Specification..... 39
 - Storage..... 20
 - Blank digits button
 - Location..... 4
 - Bus commands
 - Summary 31
 - Bus drivers 22
 - Bus learn
 - GPIB..... 30
- C**
- Caution statements 2
 - Check list
 - GPIB program 23
 - Checking
 - GPIB communication 22
 - Control function..... 21
 - Controller
 - Connecting GPIB 22
 - Controls
 - operation 8
 - Coupling
 - Selecting..... 18
 - Cover removal..... 6
 - Crystal oscillator
 - Specification..... 37
- D**
- DC
 - Selecting..... 18
 - Default settings
 - Specification..... 38
 - Delimiters
 - See Separators
- Device clear 22
- Device Trigger.....22
- Dimensions 37
- Display
 - Specification..... 37
- Display hold
 - Operating the button 16
 - Specification..... 38
- Display time
 - Specification..... 38
- Display-hold button
 - Location4
- E**
- Earthing
 - See Grounding
 - Environmental specification..... 37
 - EOI mode
 - See Output separator
 - Error codes 9,20
 - External reference input
 - Connection 6,18
 - Description of function 19
 - Location of connector3
 - Specification..... 37
- F**
- Filter
 - Specification..... 36
 - Filter On/Off
 - Selection 18
 - Free run
 - From GPIB 25
 - FREQ A/A0
 - GPIB code..... 10
 - Frequency A
 - From GPIB 24
 - GPIB code.....8
 - Selecting8
 - Specification..... 35
 - Frequency A-A0
 - Specification..... 35
 - Frequency A/A0
 - Specification..... 35
 - Frequency B
 - From GPIB 24
- GPIB code 10
- Selecting.....10
- Specification35
- Function
 - GPIB code 8
 - Selecting.....8
- Function selection
 - GPIB24
- Function-selector button
 - Location 4
- G**
- Get
 - See Triggered
 - GPIB
 - Specification 38
 - GPIB address-selector
 - Location3
 - GPIB interface-connector
 - Location3
 - GPIB-INTERFACE
 - OPERATION..... 21 - 34
 - Grounding..... 6
- H**
- HF input
 - Specification36
 - High speed dump
 - GPIB28
 - High stability oscillator
 - Installation.....20
 - Hold
 - display..... 16
 - HP controller
 - GPIB example 32
- I**
- IBM GPIB
 - GPIB example 34
 - ID?
 - GPIB22
 - Identity of the counter 22
 - Inaccuracy
 - Definition..... 36
 - Input A
 - Operation 16

- Specification 36
 Input B
 Operation 16
 Specification 36
 Input separator
 GPIB 23
 Input-A BNC-connector
 Location 4
 Input-B BNC-connector
 Location 4
 INSTALLATION 5 - 7,20
 Installing options 6
- L**
- LCD-display
 Location 4
 Listener function 21
 Local 16
 LSD displayed 36
- M**
- Measuring
 FREQ A-A0 10
 FREQ A/A0 10
 Frequency A 8
 Frequency B 10
 Period 10
 RPM A 10
 Time selection 12
 Totalize 10
 Width A 12
 Measuring time
 From GPIB 24
 GPIB code 12
 Selecting 12
 Specification 38
 Measuring-time selector-button
 Location 4
 MTCXO
 Calibration 7
 Specification 37
- N**
- Normal output format
 GPIB 28
- O**
- OPERATING INSTRUCTIONS 20
 Operating the controls 8
 Options
 Installation 6
 Ordering information 40
 Oscillator replacement
 See MTCXO
 Output mode
 GPIB 27
 Output separator
 GPIB 24
- P**
- Parallel poll 22
 Period
 From GPIB 24
 Specification 35
 Period A
 GPIB code 10
 Selecting 10
 PM 2201
 GPIB example 33
 PM 9604
 See GPIB interface
 PM 9605
 See Battery unit
 PM 9606
 See Rack mount kit
 PM 9607
 See MTCXO
 PM 9608B
 See HF input
 PM 9609
 See Carrying case
 Power
 Requirements 37
 Power switch
 Location 4
 Operating 8
 Power-inlet socket
 Location of 3
 PRODUCT PRESENTATION 3 - 4
 Programming check-list 23
 Pwidth A
 See Width A
- Q**
- Queries
 GPIB 30
- R**
- Rack mount kit
 Specification 39
 Rear feet 3
 Remote/local 22
 Removing the cover 6
 Reset
 Operating the button 16
 Specification 38
 Reset button
 Location 4
 Resolution
 Definition 36
 RPM
 Specification 35
 RPM A
 GPIB code 10
 Specification 35
- S**
- Safety 2
 Screws for removing the cover 3
 Sensitivity
 Specification 36
 Sensitivity control
 Location 4
 Separators
 Input 23
- Output 24
 Service request 21
 GPIB 26
 Short output format
 GPIB 28
 Slope
 From GPIB 25
 See Trigger slope
 Source and Acceptor Handshake 21
 SPECIFICATIONS 35 - 40
 Start/Stop Totalize
 From GPIB 25
 Operation 16
 Starting a new measurement
 See Reset
 Status byte
 GPIB 26
 Store Ao
 Specification 38
 Symbols 2
- T**
- Talk only switch 22
 Talker function 21
 Tilting support 4
 Time base
 See MTCXO
 Time out
 GPIB 25
 Totalize A
 Specification 35
 Trigger level
 Specification 36
 Trigger level A
 Operating the button 14
 Trigger level controls
 Location 4
 Trigger slope
 From GPIB 25
 Triggered mode
 From GPIB 25
 Triggering
 From GPIB 25
- U**
- Unpacking 5
- V**
- Voltage-range
 Location of 3
 Selecting 5
- W**
- Warning statements 2
 Weight 37
 Width A
 GPIB code 12
 Specification 35

<p><i>Argentina</i> Coasin S.A. Service Center Virrey del Pino 4071 1430 Capital Federal Buenos Aires Phone:+54-1-552-5248 Fax: +54-1-555-3321</p>	<p>Sigtron Instrumentos E. Servicos Ltda Rua Alvaro Rodrigues 269 - Brooklin Sao Paulo Sp Phone:+55-11-240-7359 Fax: +55-11-533-3749</p>	<p><i>Costa Rica</i> Electronic Engineering, S.A. Service Center Carretera De Circunvalacion Sabanilla Av. Novena P.O. Box 4300-1000 San Jose Phone:+506-*-253-3759 Fax: +506-*-225-1286</p>	<p><i>France</i> Fluke France S.A. Customer Support Services 37, rue Voltaire B.P. 112 93700 Drancy Phone:+33-1-4896-6310 Fax: +33-1-4896-6330</p>
<p>Viditec S.A. Service Center Lacarra 234 Buenos Aires CP 1407 Phone:+54-1-636-1199 Fax: +54-1-636-2185</p>	<p>Philips Medical Systems, Ltda. Service Center Av. Interlagos North 3493 - Campo Grande 04661-200 Sao Paulo S.P. Phone:+55-11-523-4811 Fax: +55-11-524-4873</p>	<p><i>Croatia</i> Kaltim - Zagreb Fluke Sales & Service Draga 8 41425 Sveta Jana Phone:+385-41-837115 Fax: +385-41-837237</p>	<p><i>Greece</i> Philips S.A. H, llenique Fluke Sales & Service Manager 15, 25th March Street P.O. Box 3153 177 78 Tavros Athens Phone:+30-1-4894911 Fax: +30-1-4818594</p>
<p><i>Australia</i> Philips Scientific & Industrial, Pty., Ltd. Service Center Block F, Centrecourt 34 Waterloo Road North Ryde, N.S.W. 2113 Phone:+61-2-888-0423 Fax: +61-2-888-0440</p>	<p><i>Bulgaria</i> Ac Sophilco Customer Support Services P.O. Box 42 1309 Sofia Phone:+359-2-200785 Fax: +359-2-220910</p>	<p><i>Denmark</i> Fluke Danmark A/S Customer Support Services Ejby Industrivej 40 DK 2600 Glostrup Phone:+45-43-44-1900 Fax: +45-43-43-9192</p>	<p><i>Hong Kong</i> Schmidt & Co., Ltd. Service Center 1st Floor 323 Jaffe Road Wanchai Phone:+852-9-223-5623 Fax: +852-9-834-1848</p>
<p>Philips Scientific & Industrial, Pty., Ltd. Service Center 745 Springvale Road Mulgrave Victoria 3170 Phone:+61-3-574-3666 Fax: +61-3-574-3636</p>	<p><i>C.S.F.R.</i> ELSO NA. Berance 2 16200 Praque 6 Phone:+42-2-316-4810 Fax: +42-2-364986</p>	<p><i>Ecuador</i> Proteco Coasin Cia., Ltda. Service Center Av. 12 de Octubre 2449 y Orellana P.O. Box 17-03-228-A Quito Phone:+593-2-230283 Fax: +593-2-561980</p>	<p><i>Hungary</i> MTA-MMSZ Kft. Service / General Manager Etele Ut. 59 - 61 P.O. Box 58 H 1502 Budapest Phone:+361-186-9589 Fax: +361-161-1021</p>
<p><i>Austria</i> Fluke Vertriebsges GmbH General Management Südrandstraße 7 P.O. Box 10 A 1232 Wien Phone:+43-1-61410-30 Fax: +43-1-61410-10</p>	<p><i>Canada</i> Fluke Electronics Canada, Inc. Service Center 400 Britannia Road East, Unit #1 Mississauga, Ontario L4Z 1X9 Phone:+1-905-890-7600 Fax: +1-905-890-6866</p>	<p><i>Egypt</i> EEMCO 9 Hassan Mazher St. P.O. Box 2009 St. Heliopolis 11361 Cairo Phone:+20-2-4178296 Fax: +20-2-4178296</p>	<p><i>Iceland</i> Taeknival Hf P.O. Box 8294 Skeifunni 17 128 Reykjavik Phone:+354-1-681665 Fax: +354-1-680664</p>
<p><i>Belgium</i> N.V. Fluke Belgium S.A. Sales & Service Department Langeveldpark - Unit 5 & 7 P. Basteleusstraat 2 - 4 - 6 1600 St. Pieters-Leeuw Phone:+32-2-331-2777 [Ext 218] Fax: +32-2-331-1489</p>	<p><i>Chile</i> Intronica Service Center Instrumentacion Electronica S.A.C.I Guardia Vieja 181 Of. 503 Casilla 16500 Santiago 9 Phone:+56-2-232-3888</p>	<p><i>Fed. Rep. of Germany</i> Fluke Deutschland GmbH Customer Support Services Oskar Messter Straäe 18 85737 Ismaning Münich Phone:+49-89-99611-260 Fax: +49-89-99611-270</p>	<p><i>India</i> Hinditron Services Pvt., Ltd. Service Center 204-206 Hemkunt Tower 98 Nehru Place New Delhi 110 019 Phone:+91-11-641-3675 Fax: +91-11-642-9118</p>
<p><i>Bolivia</i> Coasin Bolivia S.R.L. Casilla 7295 La Paz Phone:+591-2-340962 Fax: +591-2-359268</p>	<p><i>China</i> Fluke Service Center Service Center Room 2111 Scite Tower Jianguomenwai Dajie Beijing 100004 Phone:+86-10-512-3436 Fax: +86-10-512-3437</p>	<p>Fluke Deutschland GmbH Customer Support Services Meiendorfer Straäe 205 P.O. Box 730 370 22145 Hamburg Phone:+49-40-6797-434 Fax: +49-40-6797-421</p>	<p>Hinditron Services Pvt., Ltd. Service Center Emerald House, 5th Floor 114 Sarojini Devi Road Secunderabad 500 003 Phone:+91-40-844033 Fax: +91-40-847585</p>
<p><i>Brazil</i> Sistest Av. Ataulfo De Paiva 135 S/ 1117 - Leblon 22.449-900 - Rio De Janeiro Rj Phone:+55-21-259-5755 Fax: +55-21-259-5743</p>	<p><i>Colombia</i> Sistemas E Instrumentacion, Ltda. Service Center Carrera 21, No. 39A-21, Of. 101 Ap. Aereo 29583 Bogota Phone:+57-1-287-5424 Fax: +57-1-287-2248</p>	<p><i>Finland</i> Fluke Finland Oy Customer Support Services Sinikalliontie 3 P.O. Box 151 SF 02631 Espoo Phone:+358-0-61525-620 Fax: +358-0-61525-630</p>	<p>Hinditron Services Pvt., Ltd. Service Center Castle House, 5th Floor 5/1 A, Hungerford Street Calcutta 700 017 Phone:+91-33-247-9094 Fax:</p>

Hinditron Services Pvt., Ltd.
Service Center
Hinditron House, 23-B
Mahal Industrial Estate
Mahakali Caves Road, Andheri
East
Bombay 400 093
Phone:+91-22-836-4745
Fax: +91-22-836-4682

India

Hinditron Services Pvt., Inc.
Service Center
33/44A 8th Main Road
Raj Mahal Vilas Extension
Bangalore 560 080
Phone:+91-80-334-8266
Fax: +91-80-334-5022

Philips India Limited
Service Center
Band Box House
254 Dr. Annie Besant Road
Bombay 400 025
Phone:+91-22-493-0311
Fax: +91-22-495-0498

Indonesia

P.T. Daeng Brothers
Service Center
Philips House
J/n H.R. Rasuna Said Kav. 3-4
Jakarta 12950
Phone:+62-21-520-1122
Fax: +62-21-520-5189

Israel

R.D.T Electronics Engineer. Ltd.
Service Center
P.O. Box 58013
Tel Aviv 61580
Phone:+972-3-645-0745
Fax: +972-3-647-8908

Italy

Fluke Italia S.R.L.
Customer Support Services
Viale Delle Industrie, 11
20090 Vimodrone (MI)
Phone:+39-2-268-434-203
Fax: +39-2-250-1645

Japan

Fluke Corporation Japan
Service Center
Sumitomo Higashi Shinbashi
Bldg.
1-1-11 Hamamatsucho
Minato-ku, Tokyo 105
Phone:+81-3-3434-0188
Fax: +81-3-3434-0170

Korea

Il Myoung, Inc.
Service Center
Youngdong P.O. Box 1486
780-46, Yeogsam-Dong
Kangnam-Ku
Seoul
Phone:+82-2-552-8582-4
Fax: +82-2-553-0388

B & P International Co., Ltd.
Service Center
Geopyung Town A-303
203-1 Nonhyun-Dong
Kangnam-ku
Seoul 135-010
Phone:+82-02-546-1457
Fax: +82-2-546-1458

Kuwait

Yusuf A. Alghanim & Sons W.L.L.
P.O. Box 223 Safat
Alghanim Industries
Airport Road Shuwaikh
13003 Kuwait
Phone:+965-4842988
[Ext 2079]
Fax: +965-4847244

Malaysia

Cnn Sdn. Bhd.
Service Center
17D, 2nd Floor
Lebuhraya Batu Lancang
Taman Seri Damai
11600 Jelutong Penang
Phone:+60-4-657-9584
Fax: +60-4-657-0835

Mexico

Metrologia Y Calibraciones Ind.,
S.A. De C.V.
Industrial S.A. De C.V.
Diagonal No. 27-3er Piso
Entre Calle De Eugenia Y Ave.
Colonia Del Valle
Mexico C.P. 03100
Phone:+52-5-682-8040
Fax: +52-5-682-8040
[Ext 404]

New Zealand

Philips Scientific & Industrial,
Pty., Ltd.
Service Center
Private Bag 41904
St. Lukes, 2 Wagener Place
Mt. Albert
Auckland 3
Phone:+64-9-849-4160
Fax: +64-9-849-7814

Norway

Fluke Norge A/S
Customer Support Services
P.O. Box 6054
Etterstad
N 0601 Oslo
Phone:+47-22-65-3400
Fax: +47-22-65-3407

Pakistan

Philips Electrical Industries Of
Pakistan Ltd.
Islamic Chamber of Commerce
St-2/A, Block 9
KDA Scheme 5, Clifton
Karachi 75600
Phone:+92-21-587-4641
Fax: +92-21-577-035

Peru

Importaciones &
Representaciones
Service Center
Jr. Pumacahua 955
Lima 11
Phone:+51-14-235099
Fax: +51-14-310707

Philippines

Spark Electronics Corporation
P.O. Box 610, Greenhills
Metro Manila 1502
Phone:+63-2-700-621
Fax: +63-2-700-709

Poland

Electronic Instrument Service
(E.I.S.)
Philips Consumer Service
UL. Malechowska 6
60 188 Poznan
Phone:+48-61-681998
Fax: +48-61-682256

Portugal

Fluke Ib,rica S.L.
Sales & Services Department
Campo Grande 35 - 7ob
1700 Lisboa
Phone:+351-1-795-1712
Fax: +351-1-795-1713

Romania

RONEXPRIM S.R.L.
Customer Support Services
Str. Transilvaniei Nr. 24
70778 Bucharest - I
Phone:+40-1-6143597
Fax: +40-1-6594468

Russia C.I.S.

Infomedia
UL. Petrovsko Razumovsky
Proezd. 29
103287 Moscow
Phone:+7-095-2123833
Fax: +7-095-2123838

Saudi Arabia

A. Rajab & Silsilah Co.
Sales & Service Department
P.O. Box 203
21411 Jeddah
Phone:+966-2-6610006
Fax: +966-2-6610558

Singapore

Fluke Singapore Pte., Ltd.
Service Center
#27-03 PSA Building
460 Alexandra Road
Singapore 0511
Phone:+65-*276-5161
Fax: +65-*276-5759

South Africa

Spescom Measuregraph Pty.,
Ltd.
Service Center
SPESCOM Park
Crm. Alexandra Rd. & Second St.
Halfway House
Midrand 1685
Phone:+27-11-315-0757
Fax: +27-11-805-1193

Spain

Fluke Ib,rica S.L.
Customer Support Services
Centro Empresarial Euronova
C/Ronda De Poniente, 8
28760 - Tres Cantos
Madrid
Phone:+34-1-804-2301
Fax: +34-1-804-2496

Sweden

Fluke Sverige AB
Customer Support Services
P.O. Box 61
S 164 94 Kista
Phone:+46-8-751-0235
Fax: +46-8-751-0480

Switzerland

Fluke Switzerland A.G.
Customer Support Services
Rütistrasse 28
8952 Schlieren
Phone:+41-1-730-3310
Fax: +41-1-730-3720

Taiwan, R.O.C.

Schmidt Scientific Taiwan, Ltd.
Service Center
5th Floor, No. 178, Section 2
Min Sheng East Road
Taipei
Phone:+886-2-501-3468
Fax: +886-2-502-9692

Thailand

Measuretronix Ltd.
Service Center
2102/31 Ramkamhang Road
Bangkok 10240
Phone:+66-2-375-2733
Fax: +66-2-374-9965

The Netherlands

Fluke Nederland B.V.
Customer Support Services
Science Park Eindhoven 5108
5692 EC Son
Phone:+31-40-644310
Fax: +31-40-644321

Turkey

Pestas Prof. Elektr. Sistemler
Tic. ve San. A.S.
Selcuklar Caddesi
Meydan Apt. No. 49
Daire 23
Akattlar 80630 Istanbul
Phone:+90-212-2827838
Fax: +90-212-2827839

U.A.E.

Haris Al-Afaq Ltd.
P.O. Box 8141
Dubai
Phone:+971-4-283623
Fax: +971-4-281285

U.S.A.

Fluke Corporation
Service Center - Palatine
1150 W. Euclid Avenue
Palatine, IL 60067
Phone:+1-708-705-0500
Fax: +1-708-705-9989
E-Mail:larry@wz.fluke.com

Fluke Corporation
Service Center - Paramus
W. 75 Century Road
Paramus, NJ 07652-0930
Phone:+1-201-599-9500
Fax: +1-201-599-2093
E-Mail:gleckler@wz.fluke.com

Fluke Corporation
Service Center - Everett
Building #4
1420 - 75th St. S.W.
Everett, WA 98203
Phone:+1-206-356-5560
Fax: +1-206-356-6390
E-Mail:ed@wz.fluke.com

Fluke Corporation
Service Center - Irvine
16815 Von Karman Ave. -
Suite 110
Irvine, CA 92714
Phone:+1-714-863-9031
Fax: +1-714-757-7556
E-Mail:miker@wz.fluke.com

Fluke Corporation
Service Center
46610 Landing Parkway
Fremont, CA 94538
Phone:+1-510-651-5112
Fax: +1-510-651-4962
E-Mail:gbondy@wz.fluke.com

Fluke Corporation
Service Center - Dallas
2104 Hutton Drive
Suite 112
Carrollton, TX 75006
Phone:+1-214-406-1000
Fax: +1-214-406-1072
E-Mail:oldman@wz.fluke.com

Fluke Corporation
Service Center - Orlando
550 S. North Lake Blvd.
Altamonte Springs,
FL 32701-5227
Phone:+1-407-331-2929
Fax: +1-407-331-7710
E-Mail:wwitko@wz.fluke.com

United Kingdom

Fluke United Kingdom Ltd.
Customer Support Services
Colonial Way
Watford
Hertfordshire WD2 4TT
Phone:+44-1923-240511
Fax: +44-1923-225067
E-Mail:kgarner@uk.fluke.nl

Uruguay

Coasin Uruguay, S.A.
Service Center
Casilla de Correo 1400
Libertad 2529
Montevideo
Phone:+598-2-789015
Fax: +598-2-492199

Venezuela

Coasin C.A.
Service Center
Calle 9 Con Calle 4, Edif. Edinurbi
Apartado de Correos NR-70.136
Los Ruices
Caracas 1070-A
Phone:+58-2-241-0309
Fax: +58-2-241-1939

Vietnam

Schmidt-Vietnam Co., Ltd.
6/FI. Pedagogical College Bldg.
Dich Vong, KM 8 Highway 32
Tu Liem
Hanoi
Phone:+84-4-346186
Fax: +84-4-346-188

Countries not listed

For Eastern Europe And Middle East
Export Sales
Science Park Eindhoven 5110
5692 EC Son
The Netherlands
Phone:+31-40-644265
Fax: +31-40-644260

All other countries

Fluke Corporation
P.O. Box 9090
Mail Stop 268C
Everett, WA 98206-9090