





















Keep this manual for future reference. If you sell or give this stroller away, make sure you give this manual to the new owner. Ask them to read instructions completely.

# Elite ET100 STROLLER

## Elite Operating Instructions

**Important:** Read and follow these Safety Rules and Assembly Instructions before operating stroller. If you have any questions concerning the safe use of this product, contact InSTEP LLC at 1-800-242-6110, M-F, 8:00 a.m. - 5:00 p.m. CST or visit our web site at [www.instep.net](http://www.instep.net) or e-mail us at [info@instep.net](mailto:info@instep.net) before using.

### Safety Rules:

-  **WARNING:** Failure to follow these warnings and assembly instructions could result in serious injury or death.
-  **WARNING:** Immediately discard any plastic wrapping.
-  **WARNING:** Never allow children to fold, assemble or disassemble the stroller.
-  **WARNING:** Do not use stroller until your child is old enough to hold his/her head up on his/her own.
-  **WARNING:** Maximum weight capacity for a child in this stroller is 50 lbs. or 22.7 kg.
-  **WARNING:** Never place child in stroller on their back with their head forward and feet rearward.
-  **WARNING:** Avoid serious injury from falling or sliding out. Always use seatbelt.
-  **WARNING:** Never leave child unattended.
-  **WARNING:** Never use this stroller with roller skates or in-line skates.
-  **WARNING:** Never allow this stroller to be used as a toy or allow children to give rides to others.
-  **WARNING:** Never use stroller if it becomes damaged.
-  **WARNING:** Always be aware of traffic around you when walking or jogging.
-  **WARNING:** Always apply brakes when you stop or when you let go of handle.
-  **WARNING:** Always use an approved bicycle helmet on child.
-  **WARNING:** Always use wrist strap.
-  **WARNING:** Accessories or parcels placed in or on the stroller may cause it to become unstable.
-  **WARNING:** Maximum weight for objects in back pouch is 2.2 lbs. or 1 kg. Excessive weight may cause a hazardous unstable condition.
-  **WARNING:** Child may slip into leg openings and strangle. Never use in a reclined carriage position unless T-shield and shoulder strap placement has been re-adjusted to the seat's new position.

# IMPORTANT

Tires are shipped deflated, DO NOT OVERINFLATE. Please inflate slowly, with short bursts, to 20-25 PSI maximum. 25 PSI will provide a comfortable ride for your child.

We appreciate your purchase of one of our many fine products. We are sure that you will be satisfied with your selection. We regret that although great care and effort have been taken, occasionally problems may occur. PLEASE DO NOT RETURN PRODUCT TO THE STORE. To ensure prompt and correct handling of problems, or to answer questions, please contact us at either our Toll-Free Customer Service Number or e-mail us at our number listed below. Service will be quicker if you have your model number (found on the product and box) along with this instruction sheet ready when calling. If you have any questions concerning the safe use of this product, Please contact us 1-800-242-6110 press "1" for customer service and then "2" to speak to a representative or e-mail us at [info@instep.net](mailto:info@instep.net) or visit our web site at [www.instep.net](http://www.instep.net).

## Elite Assembly Instructions

Model No. 11-ET100

### Parts List

<u>Description</u>	<u>Qty.</u>
Frame Assembly w/seat, canopy, basket and wrist strap	1
Front Wheel Assembly with quick release axle	1
Rear Wheel Assembly with quick release axles	2

## Stroller Assembly Instructions

### Step 1. Unfold Stroller

Grasp handle with one hand, and pull up on the front fork with your other hand. Lock both plastic latches onto the lower frame (Figure A).

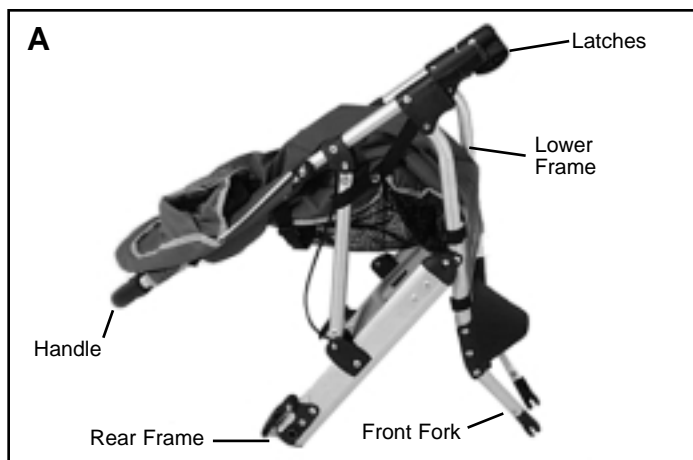

### Step 2. Rear Wheel Assembly

Turn stroller onto it's side, push in the black button on the center of the hub and insert axle into the hole in the rear frame. Pull on wheel to ensure it is locked in place. Repeat for other side (Figure B). To remove wheel push in black button on hub and pull off wheel.

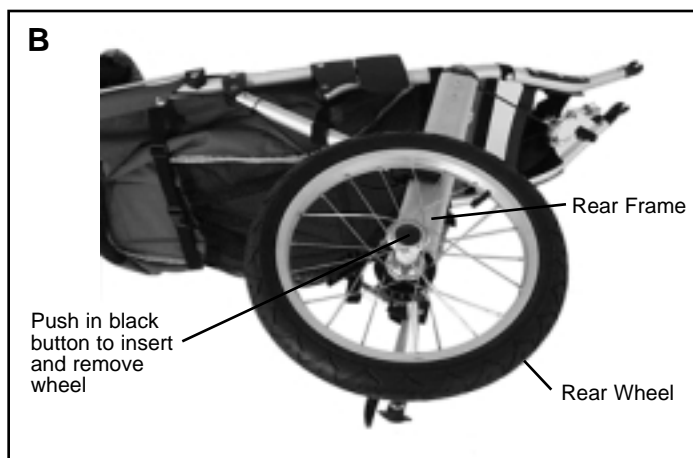



### Step 3. Front Wheel Assembly

Turn stroller upright onto its rear wheels and then tip stroller back so that the handlebar is down on the ground and the front fork is up. The front brake Quick Release lever (Q/R), located on the front fender, should be in the open position (Figure C).

Attach the front wheel by loosening the wheel's quick release (Q/R) lever on the front wheel far enough to allow the axle to slide into the front fork (Figure D). With lever in open position, hand tighten the cone nut until almost tight, then flip lever backward to the closed position to lock wheel in place. Note this step may require minor adjustment until the Q/R lever flips back with firm pressure (Figure E). Pull outward on wheel to ensure it is locked in place.

Close the front caliper brake by lowering the Q/R lever (Figure F). Spin the front wheel to make sure the brake pads do not rub and are properly aligned to the rim. If brake pad alignment is off, loosen brake pad nut with an adjustable wrench, align brake pad and retighten nut while holding the brake pad in place.

 **WARNING:** The interior jam nuts are factory installed and do not need adjustment.

 **WARNING:** Always be sure to re-engage the brake by rotating the Q/R lever forward (toward the front wheel) before using the stroller.

**Assembly is now complete!**

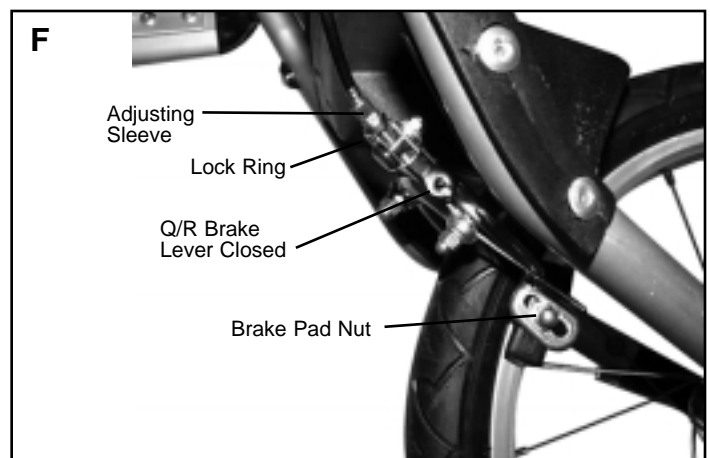
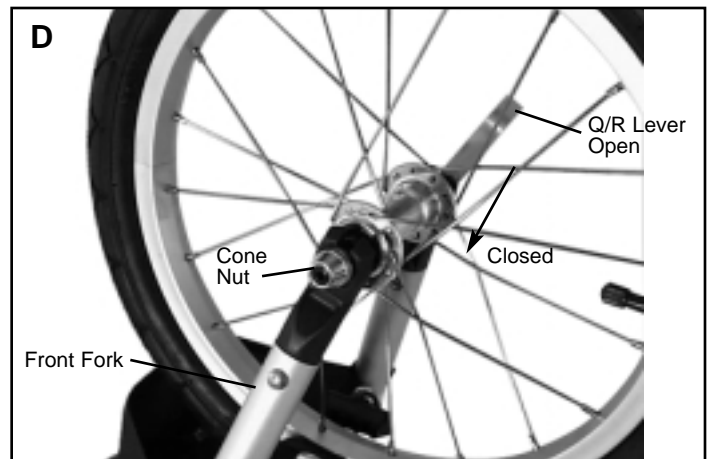
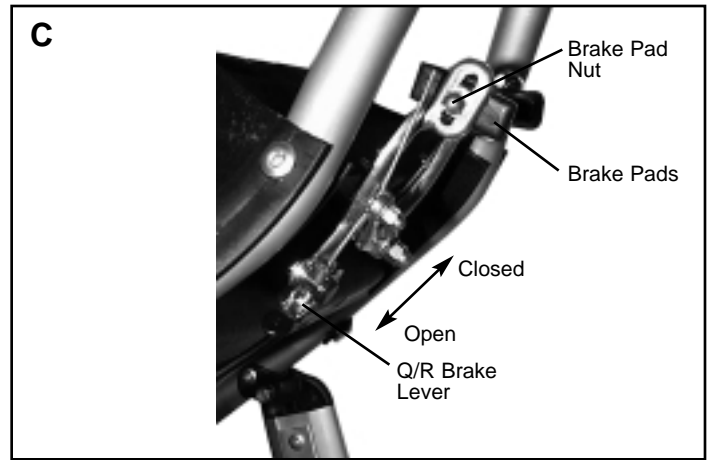

# Use Instructions

## To close/ fold stroller:

 **WARNING:** Always remove child from stroller before folding.

Push canopy back and pull the seat back forward. Flip the latches from the lower bar. Push down on the handle, the stroller will automatically begin to fold, the front wheel will fold under frame and the handle will fold downward (Figure F).

## To open stroller:

Grasp handle with one hand and pull up on the front axle mount with your other hand. Lock both plastic latches onto the lower frame (Figure G).

## To engage rear brakes:

Step lightly on the levers next to the rear wheels until the cogs of the brakes engage the cogs of the wheel. Repeat on other side. To release brake, lift levers with toe until cogs disengage (Figure H).

## To operate front caliper brake:

The front brake operates the same as a bicycle hand brake. Squeeze lever located on handlebar to engage front brake. Release lever to disengage. To engage parking brake, squeeze lever and push down lock button. To disengage lock squeeze lever again (Figure I).

 **WARNING:** Whenever child is in stroller always use the wrist strap. Before you remove the wrist strap from your wrist make sure you first engage the rear brakes or the front brake.

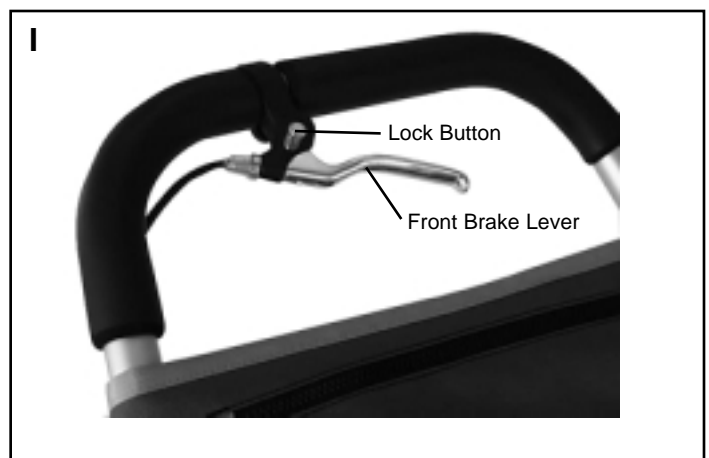
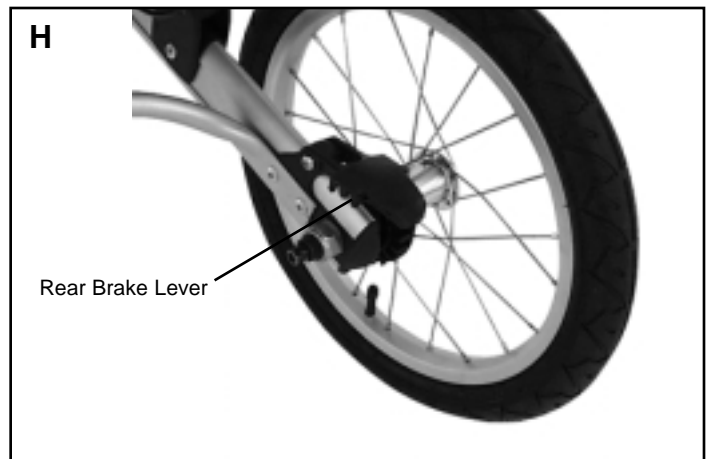
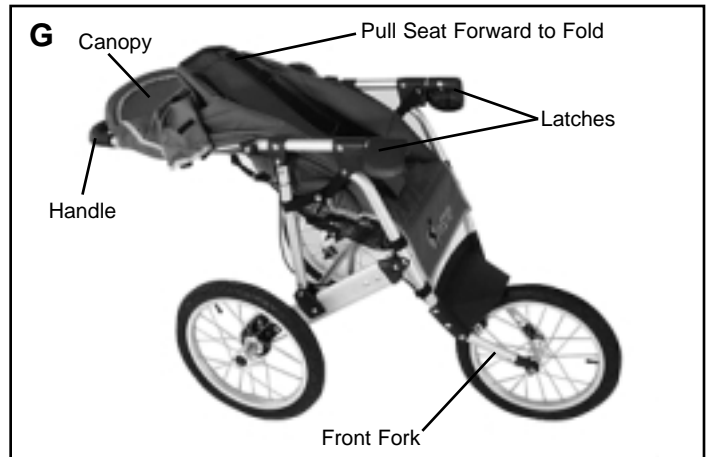
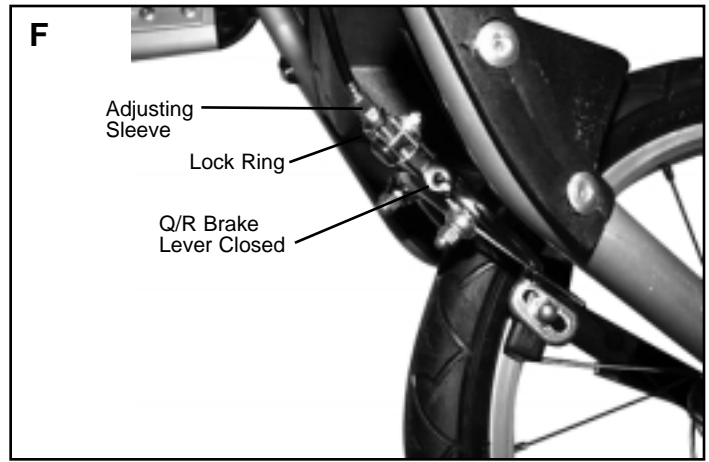

## PROPER USE OF SEAT BELTS & SHOULDER STRAPS:



**WARNING:** Avoid Serious Injury. Always use seat belts

1. Place child in seat. Make sure T-Shield is between the child's legs
2. When child is seated, place shoulder straps over the child's shoulders.
3. Bring lap belt ends around child's waist and clip into the T-Shield buckle. Adjust straps for snug fit.
4. Adjust length of shoulder straps for a proper fit (Figure J).



**WARNING:** Always adjust lap belt so that the lap belt is securely around child's waist.

### To recline seat:

- To fully recline, unhook buckle on rear section of seat back (Figure K).
- To place seat in upright position, push seat forward and reconnect buckle located on rear of seat back.
- To adjust the upright position, adjust the slides on the rear straps.



**WARNING:** Child may slip into leg openings and strangle. Never use in a reclined carriage position unless T-shield and shoulder strap placement has been re-adjusted to the seat's new position.

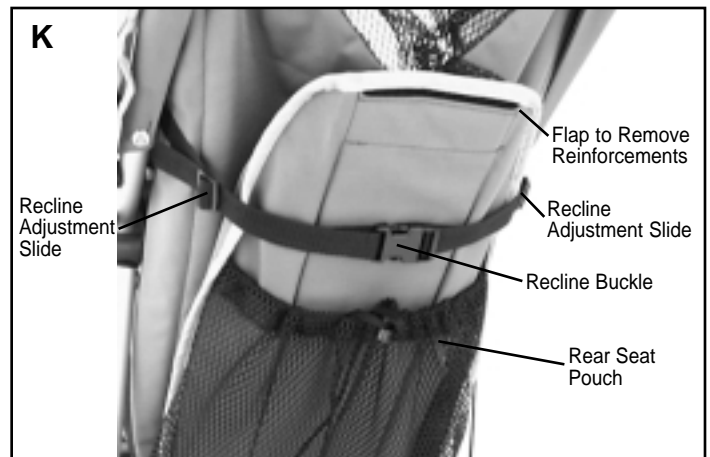
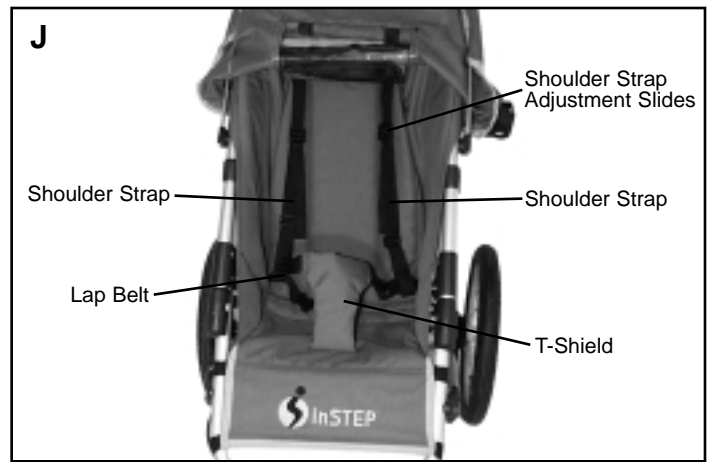

# Care and Maintenance

## Check fasteners

After one hour of use, check all fasteners to make sure they are secure. Adjust if necessary. Periodically check the stroller to ensure that it is in good operating condition.

## To adjust the stroller from veering - not rolling straight:

Open the front Q/R lever, point the front wheel forward or in the opposite direction the stroller is veering, then close Q/R lever. Repeat if necessary.

## To adjust front brake caliper:

For micro adjustment, turn the front brake caliper's adjusting sleeve. Once the brake pads are adjusted to the desired distance from the rim, tighten the lock ring. Periodically you will need to adjust the cable since it is normal for the cable to stretch from use (see Figure F, page 4).

## To clean seat and canopy:

If light cleaning is required, use a soft cloth with warm water and mild soap then air dry. If heavily soiled, remove plastic reinforcements from the backrest and unsnap seat and canopy from frame. Make sure you make note on how the seat and canopy are assembled onto the frame. Place seat and canopy in washing machine on GENTLE cycle. Replace reinforcements and snap seat and canopy back onto stroller and allow to air dry. Do not put in dryer. DO NOT BLEACH.

## To clean frame:

Wipe using a soft cloth with warm water and mild soap. Air dry. DO NOT USE polish or harsh abrasives.



**\*\*WARNING:** If you have any questions concerning the safe use of this product, please contact InSTEP LLC before using.

# 1-800-242-6110

8am-5pm CST, Monday-Friday, or MAIL to:



314 West 86th Street  
Bloomington, MN 55420  
Tel: 1-800-242-6110

or visit our web site at [www.instep.net](http://www.instep.net)  
email: [info@instep.net](mailto:info@instep.net)