Motorola

iDEN[®]

Digital Multi-Service Data-Capable Phone

i80s Phone User's Guide



NTN9866-A

Table of Contents

Introduction	5
Driving Safety Tips	6
Getting Started.....	9
<i>i80s</i> Phone Features	10
Battery	10
Turning Your <i>i80s</i> Phone On/Off	14
Security Features of the <i>i80s</i> Phone.....	15
Keypad Lock	21
Status of Your <i>i80s</i> Phone.....	24
My Information	25
Using T9® Text Input	26
Display Essentials	31
Display Screen Elements.....	31
Call Information Icons.....	34
Navigating Menus and Lists.....	35
Main Menu Options.....	36
Phonebook	39
Accessing Phonebook with an <i>i2000</i> , <i>i2000plus</i> , or GSM Phone.....	40
Phonebook Entries and Speed Dial Numbers.....	40
Phonebook Icons	40
Voice Names	41
Accessing Your Phonebook	41
About Phonebook Entries.....	42
Pause Digit Entry.....	49
Plus Dialing	51
Digital Cellular.....	53
Making Phone Calls	53
Emergency Calling	58

Receiving a Phone Call	59
Ending a Phone Call	59
Recent Calls	59
Call Timers	63
Call Waiting	64
Call Hold	66
Three-Way Calling	67
Call Forwarding	68
Messages	73
Message Center	73
Voice Mail	74
Using Voice Mail	75
Text and Numeric Messaging	76
Net Mail	78
Using Your Phone as a Modem	79
Private Calls	81
Private Call	81
Call Alerts	83
Group Call	87
Datebook	91
Datebook Icons	92
Viewing Your Datebook	92
About Datebook Events	94
Adding New Events	95
Editing Events	99
Deleting Events	99
Datebook Event Reminders	100
Customizing Datebook Set Up	100
Memo	103
Adding a New Memo	103
Viewing a Memo	103

Editing a Memo	104
Deleting a Memo	104
Java Apps	105
Accessing Java Applications	105
Running Java Apps.....	106
Downloading Java Applications.....	106
Installing Java Applications	107
Java Apps Memory	107
Deinstalling Java Applications.....	108
Voice Notes	109
About Voice Notes	109
Accessing Voice Notes.....	109
Recording a Voice Note	110
Playing a Voice Note.....	110
Adding to a Voice Note.....	111
Labeling a Voice Note.....	111
Deleting Voice Notes	112
Locking/Unlocking a Voice Note.....	112
Voice Notes Memory	113
Customizing the <i>i80s</i> Phone.....	115
Settings	115
Styles	129
Shortcuts	135
Accessories.....	139
Carrying Solutions.....	139
Batteries.....	142
Travel Chargers	143
Data Accessories	145
Other Important Information	151
Understanding Status Messages	151

Safety and General Information	153
RF Operational Characteristics	153
Electro Magnetic Interference/Compatibility.....	156
Medical Devices	156
Accessory Safety Information	161
Limited Warranty Motorola Communication Products.....	163
Limited Warranty Motorola Communication Products (International)	167
Patent and Trademark Information.....	171
 Index	 173

IMPORTANT!

Read “Safety and General Information” on page 153 before using your *i80s* phone.

Introduction

Congratulations on purchasing your Motorola iDEN *i80s* phone multi-service, data-capable, digital, portable phone. Your *i80s* phone offers:

- **Phonebook** — Your consolidated Phonebook holds up to 250 entries and allows you to store multiple contact numbers for each person, offering you various ways to communicate with your business and personal contacts.
- **SIM Card** — Your phone's SIM card holds all entries stored in your Phonebook. In addition, you have a PIN (Personal Identification Number) to keep your information safe and secure.
- **Datebook** — Schedule and keep track of appointments using your phone's Datebook feature.
- **Messages** — The Message Center allows you to manage and access your Voice Mail, Text Messages and Net Mail all from the same inbox.
- **Private and Group Calls** — You can use your phone as a two-way radio to communicate directly with business and personal contacts in your iDEN service area.
- **Fax and Data Transfer** — for circuit data faxes and file transfers.
- **J2ME™** — With the Java™ applications feature, you can choose from the many Java programs. Either download Java applications directly from the Internet, or try one of the pre-loaded applications.
- **Speakerphone** — You can enjoy hands-free communication at the touch of a button. And Speakerphone is especially great for conference calls.
- **Voice Activated Dialing** — Your *i80s* phone offers state-of-the-art Voice Activated Dialing.
- **Customization** — Use the Styles and Shortcuts features to customize your *i80s* phone to meet your individual needs. Personalize your main menu order, designate unique ring styles, create a set of behaviors for your phone to use in certain situations such as meetings or in the car. In addition other features are available such as; Voice Recognition, Voice Notes* and VibriCall™.

For more information on these and other features of the *i80s* phone, review this User's Guide. There is a Table of Contents in the front of the guide and an Index in the back of the guide to assist you in finding the specific information you want.

NOTE: Some features of your i80s phone are available only in the iDEN service area, and are indicated as such in this guide.

NOTE: This guide describes the features of the i80s phone as they were set up by Motorola. However, your carrier or your organization may have changed or added features. For more information, check with your carrier or your organization.

Driving Safety Tips

“Safety is your most important call!”

Your Motorola wireless telephone gives you the powerful ability to communicate by voice — almost anywhere, anytime, wherever wireless phone service is available and safe conditions allow. But an important responsibility accompanies that benefits of wireless phones, one that every user must uphold.

When driving a car, driving is your first responsibility. If you find it necessary to use your wireless phone while behind the wheel of a car, practice good common sense and remember the following tips:

1. Get to know your Motorola wireless phone and its features such as speed dial and redial. If available, these features help you to place your call without taking your attention off the road.
2. When available, use a hands-free device. If possible, add an additional layer of convenience to your wireless phone with one of the many Motorola Original hands-free accessories available today.
3. Position your wireless phone within easy reach. Be able to access your wireless phone without removing your eyes from the road. If you receive an incoming call at an inconvenient time, if possible, let your voice mail answer it for you.
4. Let the person you are speaking with know you are driving; if necessary, suspend the call in heavy traffic or hazardous weather conditions. Rain, sleet, snow, ice, and even heavy traffic can be hazardous.
5. If you receive an incoming call at an inconvenient time do not take notes or look up phone numbers while driving. Jotting down a “to do” list or going through your address book takes attention away from your primary responsibility — driving safely.
6. Dial sensibly and assess the traffic; if possible, place calls when you are not moving or before pulling into traffic. Try to plan calls when your car will be stationary. If you need to make a call while moving, dial only a few numbers, check the road and your mirrors, then continue.

7. Do not engage in stressful or emotional conversations that may be distracting. Make people you are talking with aware you are driving and suspend conversations which have the potential to divert your attention away from the road.
8. Use your wireless phone to call for help. Dial 9-1-1 or other local emergency number in the case of fire, traffic accident or medical emergencies.¹
9. Use your wireless phone to help others in emergencies. If you see an auto accident, crime in progress or other serious emergency where lives are in danger, call 9-1-1 or other local emergency number, as you would want others to do for you.*
10. Call roadside assistance or a special non-emergency wireless assistance number when necessary. If you see a broken-down vehicle posing no serious hazard, a broken traffic signal, a minor traffic accident where no one appears injured, or a vehicle you know to be stolen, call roadside assistance or other special non-emergency wireless number.¹

1. Wherever wireless phone service is available.

Getting Started

This section includes:

<i>i</i> 80s Phone Features	Page 10
Battery	Page 10
Turning Your <i>i</i> 80s Phone On/Off	Page 14
Turning Your <i>i</i> 80s Phone On/Off	Page 14
Security Features of the <i>i</i> 80s Phone	Page 15
Status of Your <i>i</i> 80s Phone	Page 24
My Information	Page 25
Using T9® Text Input	Page 26

i80s Phone Features

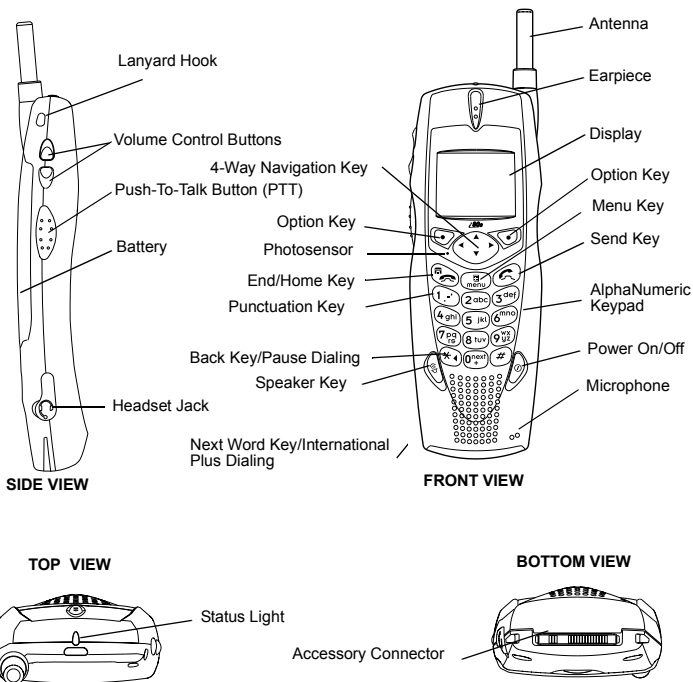

Battery

Your i80s phone comes with a Lithium Ion battery. After attaching the battery, you must charge it before you use it for the first time. See “Charging Lithium Ion Batteries” on page 142 for the charging times for your phone’s battery. The first time you charge your phone’s battery, charge for 30 minutes more than the time shown on page 142. After the initial charging, the battery can be charged in the time shown on page 142.

Instructions for Attaching and Detaching the battery may be found on page 15.

Attaching the Battery

- 1 Holding the phone face down, insert the battery into the phone in a forward and downward motion. A securing click will be heard.

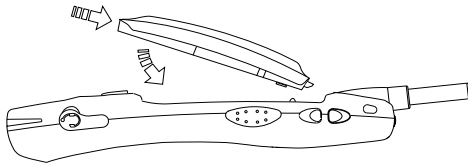

Detaching the Battery

- 1 Ensure the phone is powered off before attempting to detach the battery.
- 2 Press the battery release button and slide the battery away from the antenna.
- 3 Remove the battery by pushing the battery toward the antenna and lifting it out of the phone.

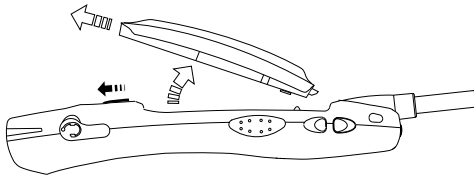

Charging the Battery

- 1 With your phone's keypad facing up, plug the charger's accessory connector into the left side of the accessory connector on the bottom of the phone.



- 2 Plug the charger into an electrical outlet.





NOTE: Your phone's screen backlight will remain lit while the battery is charging.

Battery Charging Status

The battery strength indicator icon found on your phone's display screen shows the charge amount remaining in the battery. Refer to Battery Charging, Table 1





Table 1: Battery Charging

When Using Phone

Icon Display				
Battery Strength	Low Battery	11% - 40%	41% - 70%	Fully Charged (90% -100%)

NOTE: A short, chirp-like sound indicates a low battery. This indicates that you have approximately five minutes of talk time remaining.

When Charging Battery

Icon Display	 1 flashing bar	 1 flashing bar, 1 continuous bar	 1 flashing bar, 2 continuous bars	 3 continuous bars
Battery Strength	Low Battery	31% - 60%	61% - 90%	Fully Charged (90% -100%)

NOTE: During the charging process, the battery icon will be flashing. In addition, when the battery is fully charged, the battery icon will show a fully charged battery.

Turning Your i80s Phone On/Off

To power the phone on:

- 1 For optimal signal strength, extend the antenna.
- 2 Press and hold  near the bottom of the phone until the status light glows red and a tone briefly sounds.
- 3 If the **Enter SIM PIN Code** screen displays, enter your SIM PIN. (For more information see “SIM Card Personal Identification Number (PIN)” on page 15.)

NOTE: The default SIM card PIN is 0000. It is recommended that you change your PIN to prevent fraudulent use of the SIM card (see “Changing the PIN” on page 16).

- 4 Press  under OK.

As your phone connects to the network, you will see a welcome message and a connecting message. When the **Ready** screen appears on the display, you are ready to use your i80s phone!



To power the phone off:

- 1 Press and hold  near the bottom of the phone until you see the message **Powering Off**.
- 2 Push down the antenna.

Security Features of the i80s Phone

SIM Card

Your phone comes with a built-in level of security protection through the use of the SIM (Subscriber Identity Module) card. The SIM card stores all your Phonebook information. Since this information is stored on the SIM card, not in your phone itself, you can remove the information by removing the SIM card.

The SIM card is located in the SIM Card Holder on the back of the phone, underneath the battery. You can verify that the SIM card is in place by removing the battery and viewing the SIM card through the SIM card cover.

See “Removing/Inserting the SIM Card” on page 20 for information on locating the SIM card. If there is no SIM card in your phone, notify your sales representative.

NOTE: Except for making emergency calls, your phone will not function without the SIM card.

SIM Card Personal Identification Number (PIN)

To prevent unauthorized use of your phone, your SIM card is protected by a PIN. Each time the phone is powered on, you must enter your PIN. You can change or disable your PIN if desired.

NOTE: Disabling your PIN enables anyone to use your phone. If you disable your PIN, you must still keep the SIM card in the phone to make calls.

Entering the PIN

By default, your phone is set to require you to enter a PIN.

NOTE: Your default SIM card PIN is: 0000. It is recommended that you change your PIN to prevent fraudulent use of the SIM card (see “Changing the PIN” on page 16).

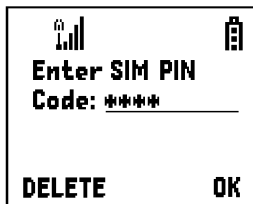

 Caution	<p>Incorrectly entering your PIN three times causes the SIM card to be blocked. To unblock your SIM card, you must contact your service provider. For more information, see “Unlocking the PIN” on page 17.</p>
---	---



- 1 From the **Enter SIM PIN** screen, enter your four- to eight-digit PIN. An asterisk appears for each character entered.

NOTE: Other than emergency dialing, you will be unable to use any of the phone functions, including receiving phone calls, until you enter the PIN.

- 2 Press  under OK.



If you enter an incorrect PIN, the message **SIM PIN incorrect: Try again** appears on your phone's screen. After three consecutive incorrect attempts, the SIM card is blocked. The phone does not allow you to attempt to enter your PIN again, even after powering the phone off and back on. If this happens, see “Unlocking the PIN” on page 17.

Changing the PIN

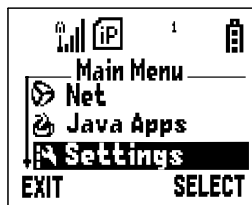
- 1 At the **Ready** screen, press  and then press  to scroll to **Settings**.





- 2 Press  under SELECT. The **Settings** screen displays.

- 3 Press  to scroll to **Security**. Press  under **SELECT** to access the **Security** screen.





- 4 At the **Security** screen, press  to scroll to **New Passwords**. Press  under **SELECT** to access the **New Passwords** screen.

- 5 At the **New Passwords** screen, press  to scroll to **SIM PIN** and press  under **SELECT**.

- 6 At the **Enter Old SIM PIN Code** screen, enter the current SIM PIN and press  under **OK**.

NOTE: The default SIM is 0000.

- 7 At the **Enter New SIM PIN Code** screen, enter the new 4- to 8-digit SIM PIN and press  under **OK**.

- 8 At the **Re-enter New SIM PIN Code** screen, re-enter the new SIM PIN to confirm, and press  under **OK**.









Unblocking the PIN

If you forget your PIN and unsuccessfully enter it three times, access to your phone will be blocked.

NOTE: Before you begin, obtain the PIN Unblocking Key (PUK) code from your service provider, then read and understand the PIN unblocking sequence. When entering the key press sequence, each key press must occur within 5 seconds of the prior key press.

 Caution	<p>If you unsuccessfully enter the PUK code ten times, the SIM card is permanently blocked and must be replaced. If this happens, all data will be lost. You will get a message to contact your service provider. If the SIM card is blocked, the i80s phone only allows outgoing Emergency calls.</p>
---	--

To unblock the PIN:

1	Press      .
2	Enter the PUK code.
3	Press  .
4	Enter a new 4- to 8-digit SIM PIN and press  .
5	Re-enter your SIM PIN and press  .
<p>If you entered the codes properly, the SIM Unlocked screen displays.</p>	

Disabling/Enabling the PIN Requirement



When the PIN requirement is enabled, you are prompted to enter your PIN each time you turn on your phone. Until a valid PIN is entered, you can use the phone only to make emergency calls.

After the PIN is accepted, the phone registers on the network and the **Ready** screen displays.

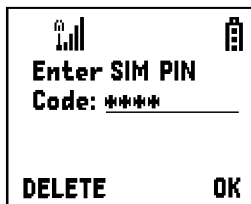
When the PIN requirement is disabled, the phone can be used without entering a PIN.

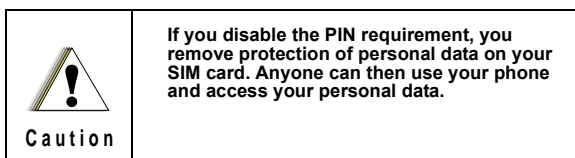





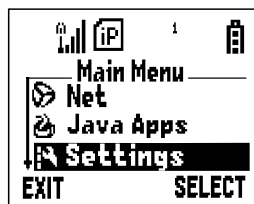

- 1 At the **Ready** screen, press  and then press  to scroll to **Settings**.





- 2 Press  under SELECT. The **Settings** screen displays.

- 3 Press  to scroll to **Security**. Press  under SELECT to access the **Security** screen.



- 4 At the **Security** screen, press  to scroll to **SIM PIN**. Press  under SELECT to access the **SIM PIN** screen.

- 5 Press  to scroll to **On** or **Off**. **On** enables the SIM PIN requirement; **Off** disables the SIM PIN requirement. Press  under SELECT.

- 6 At the **Verify SIM PIN Code** screen, enter the current SIM PIN and press  under OK.

Removing/Inserting the SIM Card



Caution

Do not touch the gold-colored areas of the SIM card.

To avoid loss or damage, do not remove your SIM card from your phone unless absolutely necessary.

- 1 With phone powered off, remove the battery cover. See “Detaching the Battery” on page 11.

- 2 With the back of the phone exposed and facing up, locate the SIM cover and gently push it to the right. Lift the cover up.

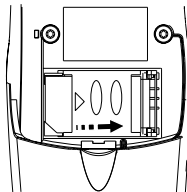

- 3 To insert the SIM card, *very carefully* place it in its holder with the *gold contact side facing down*.

To close the SIM card cover, push it down and slide forward.

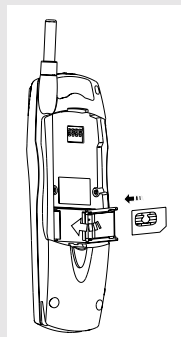

- 4 To remove the SIM card, slide the SIM card cover back and lift up (as in step 2). *Very carefully* lift the SIM out of its holder. *Do not touch the gold-colored areas of the SIM card.*

NOTE: Protect the SIM card as you would any delicate object. When the SIM card is not in the phone, you should store it in something protective, such as a mailing envelope.

Keypad Lock



The *i80s* phone includes a Keypad Lock feature that enables you to quickly lock the phone's keypad to avoid inadvertently pressing keys or placing calls. Once Keypad Lock is activated, you can only perform the following tasks:

- turn your phone on and off
- unlock the keypad
- receive incoming calls, messages, and alerts.

NOTE: Emergency calls cannot be placed while Keypad Lock is activated.

Before locking your phone's keypad, you may want to read this entire section to learn how to respond to incoming calls, messages, and alerts.

Activating Keypad Lock



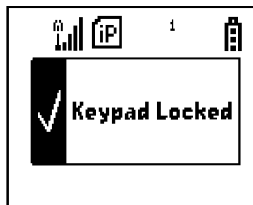

From the **Ready** screen, press  . The message **Keypad Locked** displays on your phone.





Whenever a key is pressed while in Keypad Lock mode, the unlock instructions display briefly.

Receiving Incoming Calls

When you receive an incoming phone call (see “Receiving a Phone Call” on page 59), Keypad Lock is temporarily disabled.

- 1 Press  under YES or press  to answer the call. When you end the call, the **Recent Calls** list appears. Press  or press  under EXIT to reactivate Keypad Lock and return to the **Ready** screen.

Or,

Press  under NO or press  to send the call to Voice Mail and reactivate Keypad Lock.

Receiving Private Calls

When you receive an incoming Private call, Talkgroup call, or call alert (see “Private Call” on page 81), Keypad Lock is temporarily disabled.

- 1 Press and hold the Push-To-Talk (PTT) button on the side of the phone. Begin talking after the phone emits a chirping sound. Release the PTT button to listen.

- 2 When you end the call, the **Recent Calls** list appears. Press  or press  under EXIT to reactivate Keypad Lock and return to the **Ready** screen.



Receiving New Voice Mail

When you receive new Voice Mail (see “Voice Mail” on page 74), Keypad Lock is temporarily disabled.

- 1 When **New VoiceMail Message** displays, press  under EXIT to return to the **Ready** screen and reactivate Keypad Lock.

Or,

Press  under CALL to access Voice Mail.





- 2 Once you have finished, press  to exit Voice Mail. The **Recent Calls** list displays. Press  to reactivate Keypad Lock and return to the **Ready** screen.

Receiving New Text Messages

When you receive new Text Messages (see “Text and Numeric Messaging” on page 76), Keypad Lock is temporarily disabled.

- 1 When **New Text Message** displays, press  under EXIT to return to the **Ready** screen and reactivate Keypad Lock.

Or,





Press  under READ to read the message. Press  under SAVE or DELETE. Once you have finished, press  or press  under EXIT to reactivate Keypad Lock return to the **Ready** screen.

Receiving New Net Mail



When you receive new Net Mail, Keypad Lock is temporarily disabled.

- 1 When **New Browser Message** displays, press  under EXIT to return to the **Ready** screen and reactivate Keypad Lock.

Or,

Press  under GOTO. Press  under View. Press  under OK or Reply. Once you have finished, press  until you reactivate Keypad Lock return to the **Ready** screen.

Deactivating Keypad Lock

From the **Ready** screen, press  .
The message **Keypad Unlocked** displays briefly.

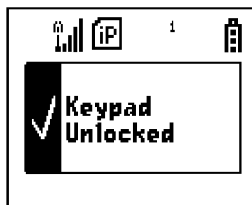

Status of Your i80s Phone

Your i80s phone has a status light that displays at the top of the phone. The status light indicates the status of your connection.







Status Light Indicator	i80s Phone Status
Solid Red	Signing on to the network. Please wait.
Flashing Red	No service or out of coverage area.
Flashing Green	In service/Ready to use.
Solid Green	In use.

My Information

You can select **My Info** from the main menu to display or edit the following:

- Name — enter your name in this field.
- Private ID — your Private ID is displayed in this field. Your Private ID is the number that others use to contact you using Private calls.
- Phone Numbers of Lines 1 and 2 — your phone's numbers are displayed in these fields. You can edit the phone numbers displayed on the **My Information** screen, but this does not change your phone numbers.
- IP Addresses — these fields display the IP addresses you use to access the Internet with your phone.
- Circuit Data Number (**Ckt**) — your circuit data number is in this field.

Viewing/Editing My Information

1	From the Ready screen, press  .
2	Press  to scroll to My Info . Press  under SELECT . The My Information screen displays.
3	Use  to scroll through the fields.
4	To edit the displayed information, press  under CHANGE . Edit information as desired, and press  under OK to save the changes. To return to the Ready screen, press  under EXIT .





Using T9[®] Text Input

Your i80s phone has embedded software, called T9[®] Text Input, that makes typing on a phone keypad much like typing on a computer keyboard: it eliminates the traditional “multi-tap” method of text entry. As you type, you press only one key per letter. T9 Text Input matches your keystrokes to words in its linguistic database of approximately 60,000 words and proper names. You may also store additional words you frequently use in your own user database, which is incorporated into the T9 database.

T9 Text Input is available when you are typing information into your Phonebook and Datebook.

T9 Text Input Entry Modes

Four text entry modes are available in T9 Text Input: Alpha, Word, Symbols, and Numeric. When you are using T9 Text Input, an icon in the top right corner of your phone’s display screen (next to the battery strength indicator icon) indicates the T9 Text Input entry mode you are using:

Icon	T9 Entry Mode Name	Used For...
	Alpha	Standard “multi-tap” keypad text entry.
	Word	Entering words and punctuation with one key-press per character.
	Symbols	Entering punctuation and symbols such as “@” or “?”.
	Numeric	Entering keypad numbers.

When you are using Phonebook or Datebook, you select your text entry mode from a menu available whenever the phone is displaying a screen that requires you to enter text (for example, the **Name:** screen or **Title:** screen).

To choose a text entry mode:

- 1 From any screen that requires text input, press  to access the **Entry Method** menu.

A check mark appears next to the current text entry mode. When you access a screen that requires text input, the default text entry mode is Alpha.

- 2 Press  to scroll to the T9 Text Input text entry mode you want to use.

- 3 Press  under SELECT.

The phone returns to the text entry screen. The text entry mode you selected is now active.

Choosing a Language

To change the language of the T9 Text Input database:

- 1 From any screen that requires text input, press  to access the **Entry Method** menu.

- 2 Press  to scroll to **Languages**.

- 3 Press  under SELECT.



- 4 Press  to scroll to the language you want T9 Text Input to use.

- 5 Press  under SELECT.

Using Alpha Mode

To enter text while in Alpha text entry mode to enter letters, numbers, and symbols:

- Press any button on the alphanumeric keypad to enter the letters, numbers, and symbols on that key.
- Press and hold a key to capitalize a letter, or press  to activate and deactivate Caps Lock.

- Pause briefly to leave the currently displayed character in place and move on to the next place in the text entry field.
- Press  to create a space in the text entry field.
- Press  under DELETE to delete one character. Press and hold  under DELETE to delete an entire entry.



Using Word Mode

In Word mode, T9 Text Input analyzes the letters on the keypad button you press and arranges them to create words. As you type, T9 Text Input matches your keystrokes to words in its database and will display the most commonly used matching word.

Special Key Functions

Some of your phone's keys assume different functions while in T9 Text Input Word mode.

Backspace and Erase

Press  under DELETE once to backspace or to erase a single character. Press and hold  under DELETE to erase the entire text entry field.

Space

Press  once to accept a word and insert a space when entering text.



Next Word in Database

Press  to display more words in the database that match the keystroke sequence you entered.

Shift and Caps Lock

Press  to make the next letter typed uppercase (Shift), to make all subsequent letters types uppercase (Caps Lock), or to go back to lowercase letters.

These icons appear in the top row of your display screen:

-  for Shift to uppercase
-  for Caps Lock

When neither of these icons appear, letters typed are lowercase.

NOTE: T9 Text Input automatically makes the first letter of a sentence uppercase.

Punctuation

In Word mode, T9 Text Input uses Smart Punctuation to quickly apply basic rules of grammar to insert the correct punctuation within a word and at the end of a sentence.

Press  to insert punctuation. One of eight basic punctuation symbols will be inserted (., - ' @ : ? ;).

Press  to change the inserted punctuation symbol to another of the eight basic punctuation symbols.

Press  to accept the punctuation and continue typing.





NOTE: Additional punctuation symbols are available in Symbols mode.

Entering a Word

To enter a word using Word mode:

1 Choose Word as your text entry mode.

2 Type a word by using one key-press per desired letter.

For example, to type “test” press    .

NOTE: The displayed word may change as you type it. Do not try to correct the word as you go. Type to the end of the word before editing.

3 If the word that appears is not the desired word, press  to change the word on the display to the next most likely word in the database.

Repeat until the desired word appears.

If the desired word does not appear, you can add it to the database of words using the instructions in “Adding Words to the User Database” on page 30.

Adding Words to the User Database

To add words to the T9 database:

1	Change from Word text entry mode to Alpha text entry mode.
2	Type the word using Alpha text entry mode.
3	Return to Word text entry mode.
4	Press  to add a space. The word you typed in Alpha text entry mode is now in the database.



NOTE: You cannot store alphanumeric combinations, such as Y2K.

Using Numeric Mode

To use Numeric text entry mode, choose Numeric as your text entry mode and press the number buttons on your keypad to enter numbers.

Using Symbols Mode

To use Symbols text entry mode:

1	Choose Symbols as your text entry mode. A row of 32 symbols appears along the bottom of your phone's display screen, just above the display option and menu icon. (Press  to view the complete row.)
2	Press  to highlight the symbol you want to enter into the text entry field.
3	Press  under SELECT to enter the symbol.

Display Essentials

Your *i80s* phone's display screen tells you what you need to know as you use your phone.

This section includes:

Display Screen Elements	Page 31
Navigating Menus and Lists	Page 35
Main Menu Options	Page 36

Display Screen Elements

Any time your phone is powered on, the display screen provides you with information and options.

The Ready Screen

The **Ready** screen displays any time the phone is powered on, but not engaged in some activity.

The **Ready** screen consist of elements common to many of the screens your phone displays:

- status icons
- text display area
- menu icon
- display options

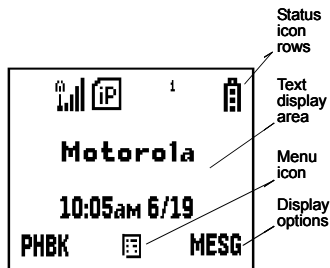



















USER TIP: You can always access the Ready screen by pressing .

Status Icons

Status icons provide you with information about your phone and its functions. These icons are *context sensitive*; meaning, the icons that appear depend on the task you are performing.

Status icons appear in the two rows at the top of the display screen. Some appear at all times. Others appear only when your phone is engaged in certain activities or when you have activated certain features.

Icon	Indicates...
	<p>Battery Strength icons — remaining battery charge. More bars on the battery indicate a greater charge. See the table on page 13 for detailed information about the meaning of each battery strength icon.</p>
	<p>Signal Strength icons — strength of the network signal. More bars next to the antenna indicate a stronger signal.</p>
	<p>Active Line icons — currently active phone line; ¹ indicates Line 1 is active; ² indicates Line 2 is active.</p>
	<p>Call Forward icons — phone is set to forward calls. See “Call Forwarding” on page 68 for more information.</p>
	<p>Phone In Use — phone is connected on an active call.</p>
	<p>Private In Use — number being called is a Private ID.</p>
	<p>Talkgroup In Use — phone is active on a talkgroup call.</p>
	<p>Packet Data Ready — phone is ready to receive data through a data cable.</p>
	<p>Packet Data Activity — phone is transmitting data.</p>
	<p>Mobile IP — phone is ready to access the Internet.</p>

	Secure Data — phone is accessing the Internet using a secure connection.
	Non-secure Data — phone is accessing the Internet using a non-secure connection.
	Roaming — phone is searching for network connections outside your local area.
	Text Message — you have one or more Text Messages or Net Mail messages.
	Voice Mail — you have one or more Voice Mail messages.
	FaxMail — you have one or more FaxMail messages.
	Speaker Off — phone's speaker is off.
	Ring/Vibe icons — you have customized the way in which the phone is set to notify you when you receive calls and other types of messages. See “Ring Style and Notification Type” on page 117 for more information.
	T9 Text Input icons — you are using T9 Text Input to enter text. See “Using T9® Text Input” on page 26 for more information.





The icon of the main menu feature currently in use always appears in the top left of the status icon rows. For a list of the main menu icons, see “Main Menu Options” on page 36.

Text Display Area

The text display area shows menu options, messages, names, phone numbers, and other information.

Call Information Icons



Each of the following icons appear on the left side of the text display area of the one-line screen or the full-sized screen, providing you with information about your phones line or lines.

Icon	Indicates...
	In Call - phone is in an active call.
	Incoming Call - phone is receiving an incoming call (not active).
	Outgoing Call - phone is placing an outgoing call (not active).
	On Hold - phone has a call on hold.
	End Call - phone has ended the active call.

Menu Icon

This menu icon  appears on any screen from which a menu can be accessed. To access a menu, press the menu key on your keypad. This key has the menu icon printed on it.

Menus are context sensitive. The menu that appears depends on the screen you access it from and the items on the menu apply to the task you are currently performing.

Pressing  or  from the **Ready** screen accesses the main menu.

Display Options

Two display options appear at the bottom of most screens. These options enable you to perform a wide variety of actions, including changing, saving and viewing information, running programs, and canceling previous actions. You activate a display option by pressing the  below it.

NOTE: Throughout the User's Guide, the option keys  and  will be represented by .

The **Ready** screen display options provide quick access to two main menu features. By default, the Phonebook (**PHBK**) and Messages (**MESG**) display options appear on the **Ready** screen. You can control which display options appear on the **Ready** screen using the phone's Personalize feature in the Settings menu (see "Changing Ready Screen Options" on page 122).

The display options on screens other than the **Ready** screen cannot be customized.

Navigating Menus and Lists

The *i80s* phone is menu driven. By navigating menus, you access submenus which lead to all of the functions and features that are built into your phone. Use the menus to store calls, manage your Phonebook and Datebook, change your phone settings, browse the Internet, and more.

Some features include lists of names, numbers, or other information. These list items can be accessed the same way menu options are.

To access the items in a menu or list, scroll through using the four-way navigation key near the center of your keypad. Scroll down by pressing the lower portion of the navigation key (⏵). Scroll up by pressing the upper portion of the navigation key (⏴). Holding down the appropriate part of the navigation key speeds up scrolling. If you continue scrolling after you have reached the bottom or top of a menu or list, you "wrap-around" to the opposite end.

If more items appear in a menu or list than can be displayed in the text area, a down arrow or up arrow appears in the left side of the screen indicating that more options may be accessed by scrolling up or down.

Down arrow

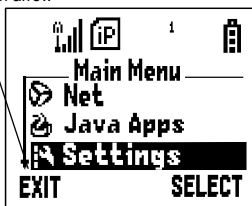











Up arrow











Main Menu Options

By default, the main menu options appear in the order determined by your service provider. You can change the order in which they appear by using the Personalize feature (see “Reordering Main Menu” on page 122)

To access the main menu, press  or  from the **Ready** screen:

Menu Item	Use to ...
 Browser	Browse the Web.
 Java	Run pre-installed and download custom Java applications on your phone.
 Settings	Customize your phone: Ring/Vibe, In Call Setup, Security, Personalize, Initial Setup, Phone Setup, Voice Volume, and Talkgroup Settings.
 VoiceNotes	Record personal messages or the incoming portion of phone calls to play back at a later time.
 Phonebook	Store and retrieve a list of stored entries for calling, editing, viewing, and deleting.
 Messages	Receive, store, access and manage Voice Mail, FaxMail, Text Messages, and Net Mail.
 Call Forward	Settings for forwarding calls in various situations.
 Datebook	Schedule and organize events, by the day or the month, such as appointments and meetings.
 Memo	Input and store numbers to access later.
 Call Timers	Display the duration of phone calls, private or group calls, circuit data use, and Kilobytes sent and received.

 Recent Calls	Access a list of the last 20 sent, received, or missed calls. Calls can be made from this list.
 Shortcuts	Associate a menu option with a number on the alphanumeric keypad for quick and easy access.
 My Info	View the name, Private ID, phone numbers for lines 1 and 2, IP address, and circuit data number of your phone.
 Styles	Create or edit a group of settings and save them as one for use in different environments.
 Call Alert	Store received call alerts to respond to at your convenience.

To choose the highlighted Main Menu selection, press  under SELECT. To exit the Main Menu and return to the **Ready** screen, press  under EXIT or press .

Phonebook

The Phonebook allows you to store up to 250 frequently used names and numbers.

When you store information in your Phonebook, it is saved on your SIM card. If you move your SIM card to another *i80s* phone, *i85s* phone or *i50sx* phone, you can access information in your Phonebook from that phone.

NOTE: If you use a different SIM card in your phone, some information stored in the phone will be lost. See “Removing/Inserting the SIM Card” on page 18.

This section includes:

Accessing Phonebook with an i2000, i2000plus, or GSM Phone	Page 40
Phonebook Entries and Speed Dial Numbers	Page 40
Phonebook Icons	Page 40
Voice Names	Page 41
Accessing Your Phonebook	Page 41
About Phonebook Entries	Page 42
Viewing Phonebook Entries	Page 42
Sorting Phonebook Entries	Page 43
Adding Phonebook Entries	Page 44
Editing Phonebook Entries	Page 49
Deleting Phonebook Entries	Page 49
Pause Digit Entry	Page 49
Plus Dialing	Page 51

Accessing Phonebook with an *i2000*, *i2000plus*, or GSM Phone

If you plan to use the information stored in your Phonebook with an *i2000*, *i2000plus*, or any other GSM phone, you must purchase CompanionPro. Go to www.motorola.com/iden or your service provider's web site for more information.

You can use CompanionPro to make the Phonebook information saved to your *i80s* phone's SIM card accessible in this type of phone.

Phonebook Entries and Speed Dial Numbers







Your Phonebook can store multiple phone numbers to a single name. For example, you can enter someone's name into your Phonebook once and then add that person's home, office, mobile phone and fax numbers to the name.





Each number stored in your Phonebook is automatically assigned a Speed Dial number that corresponds to its location in your Phonebook. Each phone number uses one Speed Dial location, even if it is assigned to the same name as other phone numbers. The phone number stored in location 1 is assigned Speed Dial number 1, the phone number stored in location 2 is assigned Speed Dial number 2, and so forth, to location 250.

Phonebook Icons

Icons that appear to the right of entries in your Phonebook convey information about those entries.

When you enter a phone number in your Phonebook, you can designate the phone number's type using any of the following icons:

	Mobile
	Private
	Work
	Main
	Home
	Pager

	Fax
	Talkgroup
	IP (Internet Protocol Address)
	Other

NOTE: The Mobile icon automatically appears to the right of the first number assigned to a name unless you choose another icon.

For more information on entering numbers into your Phonebook, see “Adding Phonebook Entries” on page 44.

The “picker” arrows appearing around the number type icon indicates multiple phone numbers stored under one name:



The Voice Name icon appearing to the left of one of the phone number type icons indicates that a voice name is associated with the Phonebook entry:

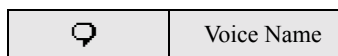

Voice Names



A voice name is an audio recording you make by speaking into your *i80s* phone that you assign to a number in your Phonebook. You can then dial the number by speaking the words you recorded into the phone. See step 6 of “Adding Phonebook Entries” on page 44 for more information on creating a voice name.

Accessing Your Phonebook

If PHBK is one of your display options:

From the Ready screen, press  under PHBK.

If PHBK is not one of your display options:

1	From the Ready screen, press  .
2	Press  to scroll to Phonebook .
3	Press  under SELECT.

USER TIP: You can also access the Phonebook by pressing  while your phone is on a phone call or private call.

This brings you to the **Phonebook** screen. From this screen, you can view, sort, add, edit, and delete Phonebook entries, check Phonebook capacity, or make calls.

About Phonebook Entries

Each Phonebook entry may contain the following information:

- The name associated with the entry. Typically, this is the name of the person whose number you are storing in the Phonebook.
- The type of number to be stored: Mobile, Private, Work, Main, Home, Pager, Fax, Other, or Talkgroup. If you don't choose a type, the number is assigned type Mobile, unless a Mobile number has already been assigned to the name.
- The number to be stored. Every Phonebook entry must contain a phone number. This number may be any type of phone number, Private ID, or Talkgroup number.
- A Speed Dial number. You may accept the default Speed Dial number or assign a different one.
- A voice name audio recording for voice-activated dialing.



Viewing Phonebook Entries





Names with more than one number assigned to them appear with  surrounding the icon to the right of the name. For example, if you had stored a home and work number for Joe Smith, the entry for Joe Smith's home phone number would look like this:

Joe Smith 

When the name is highlighted, press  to scroll to the icons representing each of the numbers assigned to that name.

To view any of the phone numbers assigned to a name:

- 1 From the **Phonebook** screen, press  to scroll to the name associated with the phone number you want to see.
- 2 Press  to view the icons representing the phone numbers assigned to that name.
- 3 When the icon representing the number you want to view is displayed, press  under VIEW.

If there is a Private ID or a Talkgroup number stored for the person, press . Then press  to scroll to **View** and press  under SELECT.
- 4 Press  to view the other numbers stored for this name.



Sorting Phonebook Entries

You can sort your Phonebook entries by:

- Name — the name you entered for the entry.
- Speed No. — the Speed Dial location of the entry.
- Voice Name — all entries with voice names appear at the top of the list.



NOTE: Private and group calls cannot be made from the Phonebook when sorted by Speed Dial location.

To sort your Phonebook list:

- 1 From the **Main Screen** screen, press  and scroll down  to view the **Phonebook Menu** screen.





- 2 Press  to scroll to **Sort By**.

- | | |
|----------|---|
| 3 | Press  under SELECT. |
| 4 | Press  to scroll to the desired sorting method: Name, Speed No., or Voice Name. |
| 5 | Press  under SELECT. |

Checking Phonebook Capacity

Your Phonebook can store up to 250 separate numbers. To see how many entries are stored in your Phonebook:

- | | |
|----------|---|
| 1 | From the Phonebook screen, Press  to view the Phonebook Menu screen. |
| 2 | Press  to scroll to Capacity. |
| 3 | Press  under SELECT.

The Capacity screen shows how many storage spaces in you Phonebook are in use and how many are empty. |

Adding Phonebook Entries



Using the following instructions, you will enter the information in the order the items appear on the Phonebook **Entry Details** screen. However, you can enter this information in any order by pressing  to scroll through the items on the **Entry Details** screen.

You can leave any item blank or unchanged by pressing  to scroll past it on the **Entry Details** screen. Only a number is required for a valid Phonebook entry.

After you have entered a phone number and any other information you wish to include, you can press  under DONE to save the Phonebook entry.

To cancel a Phonebook entry at any time, press  to return to the Ready screen. To add a Phonebook entry:

1 Access the **Entry Details** screen:

From the **Main Screen** screen, press .
Then press  to scroll to **Phonebook**.
Press  under **SELECT**

To add a **[New Entry]**, press  under **SELECT**.



2 If you want to assign a name to your Phonebook entry:

With the **Name:** field highlighted, press  under **CHANGE**.

From the **Name:** screen, enter the name using the alphanumeric keypad.

See “Using T9® Text Input” on page 26 for information about entering text into this field.

When you are finished, press  under **OK**.

The **Entry Details** screen returns with the **Type:** field highlighted.

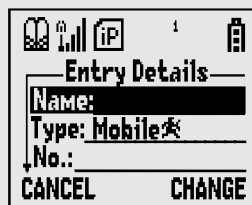

3 If you want to assign a number type other than **Mobile** to your Phonebook entry:

With the **Type:** field highlighted, press  under **CHANGE**.

From the **Type Editor** screen, press  to scroll to the type of number you want to assign to the Phonebook entry.

Press  under **SELECT**.

The **Entry Details** screen returns with the **No.:** field highlighted.

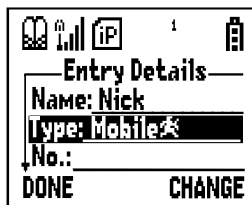

- 4 Assign a number to your Phonebook entry:

With the **No.:** field highlighted, press  under CHANGE.

Type the number using the alphanumeric keypad. For phone numbers, use the 10-digit format.

To delete a digit, press  under DELETE.

See “Pause Digit Entry” on page 49 and “Plus Dialing” on page 51 for information on using these features when storing phone numbers in your Phonebook.

NOTE: The number can be up to 20 characters long.

When you are finished, press  under OK.

The **Entry Details** screen returns with the **Speed No.** field highlighted.



- 5 The default Speed Dial number assigned to the Phonebook entry is displayed in the **Speed No.:** field. This is always the next available Speed Dial location.

If you want to assign the phone number to a different Speed Dial location:

With the **Speed No.:** field highlighted, press  under CHANGE.

Press  under DELETE to delete the current Speed Dial number.

Type the new Speed Dial number using the alphanumeric keypad.

When you are finished, press  under OK.

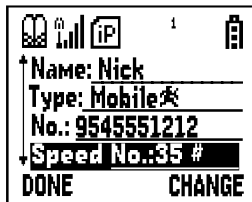

- 6 If you want to assign a voice name to the number:

With the **Voice Name:** field highlighted, press **OK** under RECORD.

As directed by the screen prompts, say and repeat the name you want to assign to the number. Speak clearly into the microphone.

An **OK** icon appears in the **Voice Name:** field indicating that the voice name has been recorded.

USER TIP: For best results, record in a quiet environment.



- 7 If you want to store more numbers to the name associated with this Phonebook entry:

Press **DOWN** to scroll to **MORE** at the bottom of the **Entry Details** screen and then press **OK** under SELECT.

A new **Type:** field appears for the additional number.

Enter the information for the additional number using step 3 through step 7.

NOTE: Each name in your Phonebook may have up to seven phone numbers one Private ID associated with it.

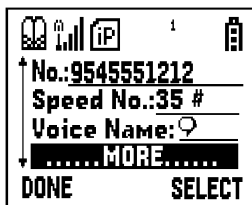



- 8 When you have entered all the information you wanted in this Phonebook entry, press **OK** under DONE.



Storing Numbers Fast



Your phone gives you two ways to store numbers quickly: from the **Ready** screen and from the Recent Calls list.



To store a number from the **Ready** screen:

- | | |
|----------|---|
| 1 | From the Ready screen, use the alphanumeric keypad to enter the number you want to store. |
| 2 | Press  to access the Dialing Menu screen. |
| 3 | With Store Number highlighted, press  under SELECT.

This displays the Entry Details screen with the No: field filled in with the number you typed. |
| 4 | If you want to add more information to the Phonebook entry, follow the applicable instructions in “Adding Phonebook Entries” on page 44. |
| 5 | Press  under DONE. |





To store a number from the Recent Calls list:

- | | |
|----------|---|
| 1 | From the Recent Calls screen, press  to scroll to the number you want to store. |
| 2 | Press  under STORE.





Or, press  to access the Rec. Calls Menu . Press  to scroll to Store . Press  under SELECT.

This displays the Entry Details screen with the No: field filled in with the number of the recent call. |
| 3 | If you want to add more information to the Phonebook entry, follow the applicable instructions in “Adding Phonebook Entries” on page 44. |
| 4 | Press  under DONE. |

Editing Phonebook Entries

1	From the Phonebook screen, press  to scroll to the entry you want to edit.
2	Press  to view the Phonebook Menu .
3	Press  to scroll to Edit .
4	Press  under SELECT. The Entry Details screen displays.
5	Follow the applicable instructions in “Adding Phonebook Entries” on page 44 to edit the various fields.

Deleting Phonebook Entries

1	From the Phonebook screen, press  to scroll to the entry you want to delete.
2	Press  to view the Phonebook Menu .
3	Press  to scroll to Delete Record or Delete Number . Delete Record deletes the name and all numbers associated with that name. Delete Number deletes the number associated with the icon that is currently displayed in the Phonebook list for the name. The name and all the other numbers will remain.
4	Press  under SELECT. A warning screen displays requiring you to confirm the deletion.

Pause Digit Entry

When storing a number, you can program your phone so that it will not only dial a number but also pause before entering another series of numbers such as a personal identification number (PIN) or password. This feature is particularly useful for accessing automated services such as voice mail and banking systems from your *i80s* phone.

Here's how it works. Let's say you have a company voice mail account that you frequently check while traveling. And, to access that account you must do the following:

- Dial your work number
- Press # while the voice mail greeting is being played
- Enter your PIN to access your messages

You can program your phone to enter all of the above information for you. All you have to do is separate each entry with a pause. If you were to program your phone to automatically input the above information, the stored data would look like this 17035551234P#P1234. In this example, the first eleven digits represent the number that must be dialed to access your voice mail. The P represents a 3 second pause. The # interrupts your greeting. The second P represents another 3 second pause. The last four digits represent your PIN.

You can use this feature not only to enter PINs and passwords but also to have the phone automatically select menu options (i.e., press 1 to hear messages).

To create a three-second pause, follow the steps below:

Press and hold  for two seconds. The pause symbol (P) will appear on the display screen.

NOTE: You can enter up to 20 characters in a single entry, stored or dialed.

NOTE: If you use a system that will not let you enter an option until the automated message has played in its entirety, you can program your phone to pause for more than 3 seconds. For example, performing the above step twice will program two pauses and cause your phone to wait 6 seconds before entering the next set of numbers.

Plus Dialing

This feature enables you to place an international call from most countries — without entering the local international access code. Use Plus Dialing for all Phonebook entries if you plan to travel outside the United States. Begin by following the instructions for “Adding Phonebook Entries” on page 44. Before you type the phone number to be stored:

- 1 Press and hold  for two seconds. A “0” appears, then changes to a “+”.

NOTE: The network translates the “+” into the appropriate international access code needed to place the call.

- 2 Enter the country code, city code, or area code, and phone number.

- 3 Follow the rest of the instructions for “Adding Phonebook Entries” on page 44.

Digital Cellular

The *i80s* phone enables you to make and receive domestic and international phone calls, make emergency calls, and be notified of a missed call.

This section includes:



Making Phone Calls	Page 53
Emergency Calling	Page 58
Receiving a Phone Call	Page 59
Ending a Phone Call	Page 59
Recent Calls	Page 59
Call Waiting	Page 64
Hands-Free SpeakerPhone	Page 62
Call Timers	Page 64
Call Hold	Page 66
Three-Way Calling	Page 67
Call Forwarding	Page 68

Making Phone Calls

Your *i80s* phone provides the following features for making phone calls:



- Direct Dial
- Phonebook
- Recent Calls
- Speed Dial
- Turbo Dial®
- Voice-Activated Dialing
- Last Number Redial
- TTY - your phone supports TTY devices and communications.

Using Direct Dial

- | | |
|----------|--|
| 1 | From the Ready screen, use the keypad to enter the 10-digit phone number you want to call. |
| 2 | Press  to place the call. |
| 3 | Press  to end the call. |

NOTE: See “Plus Dialing” on page 51 for information on making international calls.

If you make a mistake:

- To clear one digit, press  under DELETE.
- To clear all digits, press and hold  under DELETE.
- To cancel, press .





Making Calls from the Phonebook

After you have entered phone numbers into your Phonebook, you can use these numbers to make phone calls. For information on entering numbers into your Phonebook, see “Adding Phonebook Entries” on page 44.

To make calls from the Phonebook:

- | | |
|----------|--|
| 1 | From the Ready screen, if PHBK is one of your display options, press  under PHBK.

Or,

From the Ready screen, press  , then press  to scroll to Phonebook . Press  under SELECT. |
| 2 | Press  to scroll through the names in your Phonebook.

Or,



Use the alphanumeric keypad to enter the first letter of the name and press  to scroll through the names beginning with that letter.

Stop when the name of the person you want to call is highlighted. |





- 3** If more than one number is stored for the person you want to call, <> appears around the icon to the right of the person's name.

Press  to scroll through the icons representing the numbers stored for that person.

Or,

Press  under VIEW to view all the numbers stored for this person. Then press  to scroll to the number you want to call.

Or,

If there is a Private ID or a Talkgroup number stored for this person, press . When the **Phonebook Menu** appears, press  to scroll to **View** and press  under SELECT. Then press  to scroll to the number you want to call.

For more information on assigning multiple numbers to one person, see "Adding Phonebook Entries" on page 44.

- 4** Press  to place the call.



- 5** Press  to end the call.

Making Calls from the Recent Calls List

Your phone stores the numbers of the last 20 calls you received or sent in the Recent Calls list.

- 1** From the **Ready** screen, press .

Or,

From the **Ready** screen, press  to **Recent Calls** is not the first item on the list, press  to scroll to it. Press  under SELECT.

- 2** Press  to scroll the list received or sent recent calls until you reach the desired call.

3 To view additional information about the call:

Press  under VIEW.

Or,

Press  to access the **Rec. Calls Menu**. Then press  to scroll to **View** and press  under SELECT.

4 Press  to place the call.

5 Press  to end the call.

Using Speed Dial

Each phone number stored in your Phonebook is assigned a Speed Dial number. You can use the Speed Dial number to quickly place a call.

1 From the **Ready** screen, enter the Speed Dial number assigned to the phone number you want to call.

2 Press .

3 Press  to place the call.

4 Press  to end the call.

Using Turbo Dial

Turbo Dial allows you to call the numbers in your Phonebook associated with Speed Dial numbers 1 through 9 by pressing and holding the corresponding numeric key on the keypad.

Press and hold a number key (1 through 9).

NOTE: Turbo Dial cannot be accessed while the browser is active, nor while Keypad Lock or SIM Lock is active.

Making Calls Using Voice-Activated Dialing

If you have recorded a voice name for a phone number in your Phonebook (see “Voice Names” on page 41), you can use this voice name to call the number.

USER TIP: If you have difficulty making phone calls using a voice name, try assigning a longer voice name to the number. For example, if the voice name “Joe” fails to place a call to Joe Smith’s number, try assigning the voice name “Joe Smith” to the number.

- | | |
|---|---|
| 1 | From the Ready screen, press and hold  on the top of your phone until the Say Name Now screen appears. |
| 2 | Speaking into the microphone, say the voice name assigned to the phone number you want to call. |
| 3 | Your phone will play the name back to you. The call will automatically be placed. |

Last Number Redial

Press and hold  to redial the last number you called.

Placing International Phone Calls

When making an international call, you can either enter the international access code directly (011 in the United States) or use Plus Dialing.



You can make international calls from your Phonebook if you have stored the numbers with Plus Dialing. See “Adding Phonebook Entries” on page 44 and “Plus Dialing” on page 51 for more information.

NOTE: Your service default is “International Calls Restricted.” Therefore, you must call Customer Care to obtain international dialing access.

To make an international call using Plus Dialing:

- 1 Press and hold  for two seconds. A “0” appears, then changes to a “+”.

NOTE: The network translates the “+” into the appropriate international access code needed to place the call.

- 2 Enter the country code, city code, or area code, and phone number.
- 3 Press  to place the call.
- 4 Press  to end the call.

Making TTY Calls

NOTE: This feature may not be offered by your service provider.

You can use your phone to make calls using a TTY device.

When you make TTY call, the call begins in the TTY mode you last selected. You can change the TTY mode during a call. For more information on choosing a TTY mode, see “Setting TTY Mode” on page 168.

To make a call using a TTY device:

- 1 Connect one end of a 2.5mm cable into the jack on the phone. (To locate the jack, see page 8.) Connect the other end of the cord into your TTY device.
- 2 Enter the phone number you wish to call and press .



Emergency Calling

Your phone supports emergency calling. Emergency calls can be made even when the SIM card is blocked or not in the phone.

To place a call in an emergency, dial 911. You will be connected to the nearest emergency dispatch center. If you are on an active call, you must end it before calling 911.

NOTE: If you have enabled the Keypad Lock feature, you must unlock the phone’s keypad before any call can be made, including 911 emergency calls.

Receiving a Phone Call

Incoming calls are indicated by a ring, vibration or backlight illumination. Press  or any key on the keypad or press  under YES to answer the call.

Ending a Phone Call

Press  to hang up.

Recent Calls

The Recent Calls feature stores the numbers of the 20 most recent calls you have made and received, including private and talkgroup calls. You can access Recent Calls to:

- view your recent calls
- store numbers to the Phonebook
- delete recent calls
- call numbers on the Recent Calls list



NOTE: The Recent Calls list displays briefly after you end a call.

Recent Calls Icons



If the number of the recent call is stored in your Phonebook, the name associated with the phone number appears on the Recent Calls list.

For private calls, group calls, and numbers stored in your Phonebook, an icon appears to the right of the name of number indicating the Phonebook type of the number used in the call. See “Phonebook Icons” on page 40 for more information about Phonebook types.

For phone calls, an icon appears to the left of the name or number indicating the type of call:

-  indicates an incoming call
-  indicates an outgoing call
-  indicates a missed call. (Missed calls appear on your Recent Calls list only if you have Caller ID.)

For private calls, an icon appears to the left of the name or number indicating the type of call:



-  indicates a Private Call
-  indicates a Group Call

Viewing Recent Calls

To view your Recent Calls list:

1 From the **Ready** screen, press .

Or,

From the **Ready** screen, press  to scroll to **Recent Calls**. Press  under **SELECT**.

2 Press  to scroll the list of recent calls.

Getting Detailed Information About Recent Calls

To get more information about a recent call:

1 From the **Recent Calls** screen, press  to scroll to the call you want more information on.

2 Press  under **VIEW**.



Or,

Press  to access the **Rec. Calls Menu**. Then press  to scroll to **View** and press  under **SELECT**.

The screen that appears displays information such as the name associated with the number of the recent call, the number, the date, time, and duration of the call.

Storing a Recent Call Number to the Phonebook

To store a number from the Recent Calls list to the Phonebook:





1	From the Recent Calls screen, press  to scroll to the number you want to store.
2	Press  under STORE. This displays the Phonebook Entry Details screen with the No: field filled in with the number of the recent call.
3	If you want to add more information to the Phonebook entry, follow applicable the instructions in “Adding Phonebook Entries” on page 44.

Calling From the Recent Calls List



See “Making Calls from the Recent Calls List” on page 55.

Deleting Recent Calls

To delete a recent call:

1	From the Recent Calls screen, press  to scroll to the call you want to delete.
2	Press  to access the Rec. Calls Menu .
3	Press  to scroll to Delete .
4	Press  under SELECT.
5	Press  under YES to confirm the deletion.

To delete all calls on the Recent Calls list:

1	From the Recent Calls screen, press  to access the Rec. Calls Menu .
2	Press  to scroll to Delete All .

3 Press  under SELECT.

4 Press  under YES to confirm the deletion.

Accessing Voice Notes From Recent Calls

You can access the Voice Notes feature from Recent Calls and use it to record spoken messages that you can listen to later.

1 From the **Recent Calls** screen, press  to access the **Rec. Calls Menu**.

2 Press  to scroll to **New Voice Notes**.

3 Press  under SELECT.

Hands-Free Speakerphone

This feature provides the convenience of a hands-free solution, allowing you to hold impromptu meetings and place safer phone calls. The speakerphone option (SPKR) is available whenever you are on an active phone.

NOTE: During speakerphone operation, you may either speak or listen, but you cannot do both at the same time.

To turn the speakerphone on:

While on an active call, press  under SPEAKER.

While speakerphone is on, **Spkrphone On** appears in the text display area.

To turn the speakerphone off:

Press  under SPEAKER.

Use the Mute feature to listen to incoming audio without allowing sound from your phone's microphone to be transmitted over the phone line.

To turn mute on:

Press  under MUTE.

While mute is on, UNMUTE appears as a display option.

To turn mute off:

Press  under UNMUTE.

Call Timers

Call Timers measure the duration of your phone calls, Private or Group calls, and circuit data use, as well as the number of Kilobytes sent and received by your phone.

The **Call Timers** menu displays the following options:

- **Last Call** — displays the duration of your most recent phone call.
- **Phone Reset** — keeps a running total of your phone call minutes, until you reset it.
- **Phone Lifetime** — displays the total minutes of all your phone calls.
- **Prvt/Grp Reset** — keeps a running total of all of your Private and Group call minutes, until you reset it.
- **Prvt/Grp Lifetime** — displays the total minutes of all your Private and Groups calls.
- **Circuit Reset** — keeps a running total of all of your circuit data use, until you reset it.
- **Circuit Lifetime** — displays the total minutes of all of your circuit data use.
- **Kbytes Reset** — keeps a running total of the number of Kilobytes sent and received by your phone, until you reset it.



To view the **Call Timers** menu:



1 From the **Ready** screen, press .

2 Press  to scroll to **Call Timers**.

3 Press  under **SELECT**.

To view or reset a Call Timers option:

- | | |
|----------|--|
| 1 | From the Call Timers menu, press  to scroll to the Call Timers option you want to view or reset. |
| 2 | Press  under SELECT. |
| 3 | If the feature does not include an option to reset or you do not wish to reset the option, press  under DONE when you are finished viewing.

To reset a feature, press  under RESET. When the confirmation screen appears, press  under YES to confirm the reset. |

NOTE: The values displayed by Call Timers are not intended for billing purposes.

Call Waiting

Call Waiting allows you to receive a second call while you are talking on the phone. You can switch between calls so you never have to miss a call. By default, Call Waiting is always on unless you turn it off for a specific call.

If you're on a call and you receive a second call, you will:



- Hear a tone; and
- See a message on your display informing you of another incoming call.



Accepting Calls

Press  under YES. The first call is placed on hold.

Switching Between Calls

When you accept a second call while you are talking on the phone, your display shows the name or number of each call. An icon appears to the left of each name or number indicating that the call is on hold  or active .

Press  under SWITCH to switch between calls.

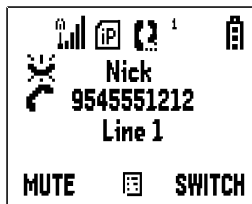

Declining Calls





Press  under NO. If you subscribe to Voice Mail, the call will be forwarded to your Voice Mail box.

Ending the Active Call



Press .

Turning Off Call Waiting

If you do not want to be interrupted during a call, you can turn Call Waiting off prior to making/receiving a call.

- 1 From the **Ready** screen, press . Press  to scroll to **Settings**, and press  under SELECT.
- 2 Press  to scroll to **In Call Setup** and press  under SELECT.

3 Press  to scroll to **Call Waiting** and press  under CHANGE.

4 Press  to scroll to **Off** and press  under SELECT.

Call Waiting is now disabled for the next call. It will automatically reset to **On** when you hang up.

Call Hold

When you are on an active call, you can place the call on hold and make a second call.

To place an active call on hold:

1 Press  to access the **Calls Menu**.

2 Press  to scroll to **Hold**.

3 Press  under SELECT.

4 If you have not placed a second call, you can resume this call by pressing  under RESUME.

To place a second call while the first call is on hold:

1 Enter the second phone number you want to call. Or select the number from your Phonebook by pressing  and selecting **Phonebook**.

2 Press  to place the second call.

To toggle between the two calls:

Press  under SWITCH.











To end the active call:

Press . The call on hold becomes active.

Three-Way Calling

Using Three-Way Calling, you can combine two ongoing phone calls into one conversation. While on an active call, you can make a second call and combine the two calls. When you place or receive a phone call, the 3-WAY option appears in the bottom right-hand corner of the display screen.

To make a three-way call:

1	Place or receive a phone call.
2	While on the call, press  to access the Call Menu .
3	Press  to scroll to 3 Way .
4	Press  under SELECT. The first call will be placed on hold.
5	Enter the second phone number you want to call and press  to place the second call. Or, access the number from your Phonebook: Press  and then press  to scroll to Phonebook . Press  under SELECT. To place the call, see “Making Calls from the Phonebook” on page 54.
6	After you reach the second individual, press  .
7	Press  to scroll to 3 Way .
8	Press  under SELECT. Both calls will appear on your display.







Call Forwarding

Call Forwarding forwards calls to the number you designate. The following Call Forwarding options are available:

- **Off** — No calls are forwarded.
- **All Calls** — When this option is turned on, all calls will be sent automatically to a number you specify.
- **Detailed** — Choosing this option enables you to forward calls you missed to different numbers, or to Voice Mail, depending on why you missed each call:
 - **Busy** — your phone is engaged in other activities.
 - **No Answer** — you do not answer. The phone will ring 4 times before forwarding the call.
 - **Unreachable** — your phone is out of coverage or powered off.









You can forward Line 1 and Line 2 independently.

When your phone is set to forward all calls, one of the following icons appears on the top row of your display screen to indicate the call forwarding option you have chosen:



Icon	Indicates...
	Line 1 is active; calls from Line 1 are being forwarded.
	Line 1 is active; calls from Line 2 are being forwarded.
	Line 1 is active; calls from Line 1 and Line 2 are being forwarded.
	Line 2 is active; calls from Line 1 are being forwarded.
	Line 1 is active; calls from Line 2 are being forwarded.
	Line 2 is active; calls from Line 1 and Line 2 are being forwarded.

NOTE: Call Forwarding must be set to Detailed with the Voice Mail access number to receive Voice Mail messages. This is the default setting.

Turning On Call Forwarding

1	Press  then press  to scroll to Call Forward .	
2	Press  under SELECT .	
3	At the Call Forward screen, the Forward field is highlighted. Press  under CHANGE .	
4	Press  to scroll to All Calls .	
5	Press  under SELECT .	
6	Press  to scroll to the To field and press  under CHANGE .	



7 To activate a call forwarding number:

If you have never used Call Forwarding before, the **Forward** screen appears. To enter a call forwarding number, type the number on your phone's keypad or press  under SEARCH to select from numbers stored in your phone. Press  under OK.

Or,

If you have used Call Forwarding before, the call forwarding number you last used is displayed. Press  under CHANGE to access the **Forward** screen.

To forward your calls to this number, press  under OK.

To forward your calls to a different number, press and hold  under DELETE to erase the displayed number. Type the new number on your phone's keypad or press  under SEARCH to select from numbers stored in your phone. Press  under OK.



Your calls will now be forwarded to the number that you selected.



Turning Off Call Forwarding

1 Press  then press  to scroll to **Call Forward**.

2 Press  under SELECT.

The **Call Forward** screen displays with the **Forward** field highlighted.

3 Press  to scroll to the **To** field and press  under CHANGE.

4 Press  to scroll to **Off** and press  under SELECT.

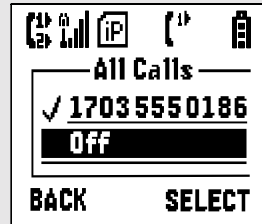

NOTE: You can use the Detailed setting to forward calls to other numbers if desired. However, it is recommended that you leave Detailed set to the Voice Mail access number and use the All Calls setting if you wish to forward your calls to another number.

Setting Call Forwarding to Voice Mail



In most cases, turning off Call Forwarding restores your ability to receive Voice Mail messages when you are unavailable (see “Turning Off Call Forwarding” on page 70). If you have completed those steps but are still not able to receive Voice Mail messages, you can reset Call Forwarding to Voice Mail.





For you to receive Voice Mail messages, Call Forwarding must be set to Detailed with your Voice Mail access number:

1 Press  then press  to scroll to **Call Forward**.

2 Press  under SELECT.

The **Call Forward** screen displays with the **Forward** field set to **Detailed**.

3 Press  to scroll to the **If Busy** field and press  under CHANGE.

4	The call forwarding number you last used is displayed. Press  under CHANGE. If this is your Voice Mail access number (the first six digits of your 10-digit phone number followed by 6245), go to step 7.
5	Press and hold  under DELETE to erase the displayed number.
6	Enter your Voice Mail access number. Your Voice Mail access number is the first six digits of your 10-digit phone number, followed by 6245. (For example 7035556245.)
7	Press  under OK.
8	Repeat step 3 through step 7 for the If No Answer field and the If Unreachable field.
9	When finished, press  under EXIT.

NOTE: You can use the Detailed setting to forward calls to other numbers if desired. However, it is recommended that you leave Detailed set to the Voice Mail access number and use the All Calls setting if you wish to forward your calls to another number.

Messages

The main topics covered in this section are listed below:

Message Center	Page 73
Voice Mail	Page 74
Text and Numeric Messaging	Page 76
Alert Flag Notification	Page 74
Net Mail	Page 78
Using Your Phone as a Modem	Page 79

Message Center

The Message Center enables you to access all messaging services through one screen.

To access the Message Center:

If MMSG is one of your display options:

From the **Ready** screen, press  under MMSG.

If MMSG is not one of your display options:



1 From the **Ready** screen, press .

2 Press  to scroll to **Messages**.

3 Press  under SELECT.

The **Message Center** screen displays the number of messages you have in each message service — **VoiceMail** (Voice Mail), **Text Msgs** (Text and Numeric Messages), and **NetMail** (Net Mail).

To access any message service:

- 1 From the **Message Center** screen, press  to scroll to the message service you want to access.
- 2 Press  under the display option on the right. This option varies depending on the message service selected.



Voice Mail

New Message Indicators

When you receive a new message:

- **New VoiceMail Message** will display on the screen.



- Your phone will alert you every 30 seconds until you press  under CALL or  under EXIT. (If you are on a call, your phone will alert you once during the call.)

Transferring Calls to Voice Mail

Press  under NO while your phone is ringing to transfer incoming calls directly to Voice Mail.

Using Voice Mail

Logging Into Voice Mail

- 1 From the **Ready** screen, press **⊙** under **MESG** to open up the Message Center screen.



- 2 **Voicemail** should be highlighted to indicate that it is selected. If it isn't highlighted, press **⊙** to scroll to the Voicemail field.

The number of new messages and the total number of messages are displayed.

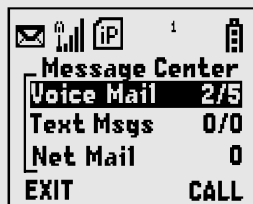

- 3 Press **⊙** under **CALL** to log into your Carrier's Voice Mail System. **Calling** displays as you are connected to the network.

Text and Numeric Messaging

With Text and Numeric Messaging, your phone will:

- Allow numeric messages up to 20 characters in length and text (alpha) messages up to 140 characters in length.
- Accept your messages even if you are unavailable, if your phone is turned off, or if you are busy on another call.
- Alert you of a new text or numeric message, even if you are on another call.
- Store a message if you are making a Private or Group call and deliver it upon completion of the call.
- Store the message if you are outside of the coverage area and deliver it as soon as you are back in a coverage area.
- Attempt continuous delivery of messages until successful, for up to 7 days.

With Text and Numeric Messaging, your phone will:

- Refer to text and numeric messages as Text Messages.
- Stamp the message with the time and date the message was left.
- Store up to 16 messages at a time, that will remain until you delete them.

NOTE: “Mail Waiting, Memory Full” displays when 16 message registers are full. (Messages must be erased before you can receive others.)

- Allow for “Auto Call Back” of a phone number that is included within a message, by pressing . If the message contains two phone numbers, Auto Call Back will dial the last number.

New Messages Indicators

When you receive a new message:

- **New Text Message** will display on the screen.



- Your phone will alert you every 30 seconds until you press under READ or under EXIT. (If you are on a call, your phone will alert you once during the call.)

Accessing New Messages

When you receive a message, you can view it immediately or later:







View a Message Immediately

1	Press <input type="radio"/> under READ. The message displays.
2	If the message fills more than one screen, use <input type="radio"/> to scroll through the rest of the message.
3	Press <input type="radio"/> under SAVE to save the message. Or, Press <input type="radio"/> under DELETE to delete the message.

Viewing a Message Later

Press under EXIT. The icon will appear on the second line of the **Ready** screen to remind you that you have a stored message.

Viewing Stored Messages



1	In the Message Center screen, press  to scroll down to Text Msgs. The number of new messages and the total number of messages are displayed.
2	Press  under SELECT . The Text Msg Inbox screen appears.
3	Press  to scroll to the message you want to read and press  under READ .
4	If the message fills more than one screen, use  to scroll through the rest of the message.
5	Press  under SAVE to save the message. Or, Press  under DELETE to delete the message.

Net Mail

With Net Mail, you can send text and numeric messages in any of three ways:

- from your *i80s* phone
- from a web site provided by your service provider
- from any email application

When you receive a new message:

- Words will display on your phone's display screen indicating that you have a Net Mail message. (The exact words displayed are determined by your service provider.)
- Your phone will alert you every 30 seconds until your press  to access the message or press  to exit the screen.

If you choose to exit the screen and view the message later, the  icon will appear on the second line of the **Ready** screen to remind you that you have a stored message.

You can view new or stored Net Mail messages at any time by access the Message Center. For more information, see "Message Center" on page 73.

Using Your Phone as a Modem

NOTE: Some features may be network dependent or subscription only, and may not be available in all areas. Contact your service provider for more information.

You can use your *i80s* phone as a modem for data transfer from your laptop, handheld device, or desktop computer. This is particularly useful when there is no wired phone line (wall jack) available.

You simply attach a data cable (available separately) to your phone and your computer. From that point, your phone is your modem. This allows you to send or receive time-critical information such as email, a field service report, or files. In addition, you can also send or receive faxes.

This type of wireless connection uses one of two types of data connection: circuit-switched data and packet data.

- Circuit-switched data is typically used for sending and receiving faxes and for transferring large files.
- Packet data is used for small file transfers such as email.

To use these services, you must install the iDEN Wireless Data Services software (available separately). For more information on setting up your computer and your *i80s* phone for Packet and Circuit Data calls, see the *Wireless Data Services User's Guide* and contact your carrier.

Private Calls

The main topics covered in this section are listed below:

Private Call	Page 81
Making Calls Using Voice Activated Dialing	Page 82
Call Alerts	Page 83
Group Call	Page 87

Private Call

There are several ways to reach an individual using Private calls. Whether you dial the person's Private ID directly or store it in your Phonebook or Recent Calls list, you must have the individual's Private ID to use Private calls. To learn how to store names and numbers, see "Phonebook" on page 39.

USER TIP: To find out your own Private ID number, see "My Information" on page 25.

Making a Private Call from the Keypad

- 1 Enter the Private ID of the person you are trying to call.
- 2 Press and hold the Push-To-Talk button (PTT) button on the side of the phone. Begin talking after the phone emits a chirping sound.
- 3 Release the PTT button to listen.





Making a Private Call from the Phonebook

If you have stored a person's Private ID in your Phonebook, you can use your Phonebook to make a Private call to that person:

- 1 From the **Ready** screen, press .
- 2 Press  to scroll to the **Phonebook**. Press  under SELECT.

- | | |
|---|--|
| 3 | From the Phonebook screen, press  to scroll through the names until the desired name is highlighted. |
| 4 | Press and hold the PTT button on the side of the phone. Begin talking after the phone emits a chirping sound. |
| 5 | Release the PTT button to listen. |

Making a Private Call from the Recent Call List

- | | |
|---|--|
| 1 | From the Ready screen, press  . |
| 2 | Press  to scroll to the Recent Calls . Press  under SELECT. |
| 3 | From the Recent Calls screen, press  to scroll through the names and numbers until the desired name or Private ID number is highlighted. |
| 4 | Press and hold the PTT button on the side of the phone. Begin talking after the phone emits a chirping sound. |
| 5 | Release the PTT button to listen. |

Making Calls Using Voice-Activated Dialing

If you have recorded a voice name for a Private ID in your Phonebook, see “Adding Phonebook Entries” on page 44, you can use this voice name to call the number.

- | | |
|---|---|
| 1 | From the Ready screen, press and hold  on the side of your phone until the Say Name Now screen appears. |
| 2 | Speaking into the microphone, say the voice name assigned to the Private ID you want to call. |
| 3 | Your phone will play the name back to you. Press the PTT button. |

USER TIP: If you have difficulty making phone calls using a voice name, try assigning a longer voice name to the number. For example, if the voice name “Joe” fails to place a call to Joe Smith’s number, try assigning the voice name “Joe Smith” to the number.

Receiving a Private Call

When you receive a Private call, your phone emits a chirping sound and **Private in Use** appears on the screen. The Private ID or the name of the caller (if stored in your Phonebook) displays on the screen.

To respond to a Private Call:

- | | |
|---|--|
| 1 | Wait for the caller to stop speaking. |
| 2 | Press and hold the PTT button. Begin talking after the phone emits a chirping sound. |
| 3 | Release the PTT button to listen. |

Storing Private IDs

For information store Private ID numbers to your Phonebook, see “Adding Phonebook Entries” on page 44.

For information on how to quickly store Private ID numbers, see “Storing Numbers Fast” on page 48.

Call Alerts

You can send a call alert, which lets recipients know that you would like to talk with them. When you send an alert, the recipient will receive a series of beeps and your name or Private ID will appear on the display.

Placing a Call Alert from the Keypad

- | | |
|---|--|
| 1 | Enter the Private ID of the person you want to call. |
|---|--|

- 2 Press **⏪** under ALERT. The **Ready to Alert** screen displays.
- 3 Press and hold the PTT button until **Alert Successful** displays. The alert sounds intermittently until the user of the phone answers, queues, or clears the alert.

Placing a Call Alert from the Phonebook

- 1 From the **Ready** screen, press **⏪**.
- 2 Press **⏩** to scroll down to **Phonebook**. Press **⏪** under SELECT.
- 3 From the **Phonebook** screen, press **⏩** to scroll to the Phonebook entry for the person you want to alert.
- 4 Press **⏪** under ALERT. The **Ready to Alert** screen appears.

- 5 Press and hold the PTT button until **Alert Successful** displays. The alert sounds intermittently until the user of the phone answers, queues, or clears the alert.

Ready to Alert Screen



Ready to Alert is used to confirm your request for the alert and to prompt you to push the PTT button:

- If you press the PTT button, the call alert is sent, and the phone displays the **Recent Calls** screen.
- For call alerts placed from the keypad, pressing **⏪** under CANCEL causes the phone to return to the **Dial** screen with the previously entered number displayed.

- For call alerts placed from the Phonebook, pressing  under CANCEL causes the phone to return to the **Phonebook** screen.
- If you do nothing, the phone will revert to the **Ready** screen.

Receiving Call Alerts



When you receive a call alert, your phone emits a chirp and displays the name or number of the caller. You can answer, queue, or clear the call alert:

- To answer a call alert, press the PTT button.
- To queue a call alert, press  under QUEUE.
- To clear the call alert, press  under CLEAR.

Call Alert Queue





Call alert queuing enables you to save call alerts in a list, or queue. To store a call alert in the call alert queue, press  under QUEUE when you have received an incoming call alert.

Accessing the Call Alert Queue

1	From the Ready screen, press  .
2	Press  to scroll to Call Alert .
3	Press  under SELECT. The Call Alert Queue screen displays.





Viewing Call Alert Date and Time

To find out the date and time a call alert was received:



1	From the Call Alert Queue screen, press  to scroll to the desired call alert.
2	Press  to access Call Alert Menu .
3	Press  to scroll to View .
4	Press  under SELECT.

Sorting Call Alerts

To sort your call alerts by the order they were received:



1	From the Call Alert Queue screen, press  to access Call Alert Menu .
2	Press  to scroll to Sort By .
3	Press  under SELECT .
4	Press  to scroll to First on Top or Last on Top .
5	Press  under SELECT .

Responding to a Call Alert From the Queue

1	From the Call Alert Queue screen, press  to scroll to the call alert you want to respond to. You can respond by sending a call alert or placing a Private call.
2	To send a call alert, press  under ALERT and then press the PTT button. Or, To place a Private call, press the PTT button. The call alert will be removed from the queue.

Deleting a Call Alert From the Queue

To delete a call alert from the queue:

1	From the Call Alert Queue screen, press  to scroll to the entry you want to delete.
2	Press  to access Call Alert Menu .
3	Press  to scroll to Delete .

4 Press  to SELECT.

5 When the confirmation screen appears, press  under YES to delete all call alerts.

To delete all call alerts from the queue:

1 From the **Call Alert Queue** screen, press  to access **Call Alert Menu**.

2 Press  to scroll to **Delete All**.

3 Press  to SELECT.

4 When the confirmation screen appears, press  under YES to delete the entry.

Group Call

In a Group call, you can communicate instantly with a group of people that you have previously set up as a Talkgroup. Your sales representative must set up your Talkgroups by providing you with a Talkgroup number for each Talkgroup. After you have the number, you can assign each Talkgroup number a name and store it in your phone (see “Storing a Talkgroup” on page 87).

Talkgroups appear on your display as numbers or programmed names such as **SALES TEAM** or **Talkgrp 5**. Your phone can store up to 30 Talkgroups. You can initiate or participate in Group calls for Talkgroups that have been created for you and that are stored in your Phonebook.



Storing a Talkgroup

1 From the **Ready** screen, press .



2 Press  to scroll to **Phonebook**.

3 Press  under SELECT.



4 Press  to scroll to **New Entry**.

5	Press  under SELECT. The Entry Details screen displays.
6	Enter the information as you would any other Phonebook entry. (See “Adding Phonebook Entries” on page 44.) When you get to Type , make sure that you select Talkgroup .
7	Enter the Talkgroup name or number.
8	When you have completed the Entry Details , press  under DONE.



Making a Group Call from the Keypad

1	Press  and then enter the Talkgroup number of the group that you want to call.
2	Press and hold the PTT button on the side of the phone or press  under ALERT, and speak. The phones of individuals in the Talkgroup will emit a chirping sound to alert them that someone is calling.
3	Release the PTT button to listen.

Making a Group Call from the Phonebook

1	From the Phonebook screen, press  to scroll to the name of the Talkgroup you want to call.
2	Press and hold the PTT button on the side of the phone or press  under ALERT, and speak. The phones of the people in the Talkgroup will emit a chirping sound to alert them that someone is calling.
3	Release the PTT button to listen.

Making a Group Call from the Recent Calls List

- | | |
|---|--|
| 1 | From the Recent Calls screen, press  to scroll to the name of the Talkgroup you want to call. |
| 2 | Press and hold the PTT button on the side of the phone or press  under ALERT , and speak. The phones of individuals in the Talkgroup will emit a chirping sound to alert them that someone is calling. |
| 3 | Release the PTT button to listen. |

Receiving a Group Call

When you receive an incoming Group call, your phone emits a chirp.









To respond to a Group call:

- | | |
|---|--|
| 1 | Wait for the caller to finish speaking. |
| 2 | Press and hold the PTT button to talk. Release the PTT button to listen. |

Group-Silent Programming

Group-Silent programming enables you to silence incoming Group alerts and communication.

Turning Group-Silent On or Off

- | | |
|---|--|
| 1 | From the Ready screen, press  . |
| 2 | Press  to scroll to Settings . Press  under SELECT . |
| 3 | Press  to scroll to Tkgrp Settings . Press  under SELECT . |
| 4 | With the Silent field highlighted, press  under CHANGE . |
| 5 | Press  to scroll to On or Off . |
| 6 | Press  under SELECT . |

Datebook

The Datebook is a calendar in your *i80s* phone that enables you to schedule and organize events, such as appointments and meetings. Schedules can be created and viewed for specific days, and reminder alarms can be set so that you never miss important events.

You can view upcoming events by week or by day. The Datebook stores and manages 250 events over a 13-month period (12 months ahead and 1 month back).

NOTE: The time and date format and the year used in Datebook can be set by you. Before using Datebook for the first time, ensure that the current year is correct. See “Initial Setup” on page 123 for more information.

This section includes:

Datebook Icons	Page 92
Viewing Your Datebook	Page 92
About Datebook Events	Page 94
Adding New Events	Page 95
Editing Events	Page 99
Deleting Events	Page 99
Datebook Event Reminders	Page 100



Datebook Icons

There are several icons commonly used in the Datebook application:

Symbol	Description
•	Event without a start/end time
>	More options are available
↻	Recurring Appointment
🔔	Datebook Alarm
→	Used to move through fields when setting a time and date.

Viewing Your Datebook

To access your Datebook:

1	From the Ready screen, press  .
2	Press  to scroll to Datebook .
3	Press  under SELECT.

Information in your Datebook can be viewed in three ways: by the week, the day, or the event.

This information is structured hierarchically. When you access the Datebook, it displays the current week. You can select a day to view and display the events of that day. When the events of a day are displayed, you can select an event to view and display details of that event.

Viewing a Week

When you access your Datebook, the current week is displayed. You can scroll to other weeks by pressing .

The dates of the displayed week appear at the top of the text area of your phone's screen.

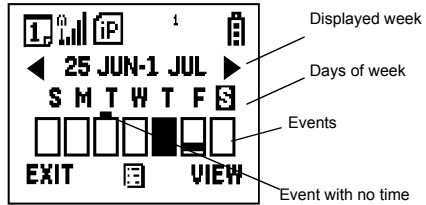



Below the dates are letters indicating the days of the week. When you access your Datebook, the current day is highlighted. You can scroll to other days by pressing .

Below each letter is a 12-hour time window for each day. Scheduled events are shown within the time window in black.

A small bar on top of the time window indicates an event on that day that does not have a time of day associated with it, such as a birthday.

Viewing a Day



To view a day in your Datebook:

- 1 With a week displayed, select the day you want to view by pressing  until the letter for that day is highlighted.
- 2 Press  under VIEW.

The day and date appear at the top of the text display area. Events for the day selected are listed by time. Events without times are displayed at the top of the list with a bullet to the left of them.

Viewing Event Details



To view the details of an event:

1	Select and view the day containing the event you want to view.
2	Press  to scroll to the event.
3	Press  under VIEW.

This displays event details such as day of week, time, title, duration, alarm time, and repeat cycle. For more information about events, see “About Datebook Events” on page 94.

Viewing Today

You can easily go to the current day when viewing your Datebook:



1	While viewing any week, day, or event, press  . This displays the Datebook Menu with Go to Today highlighted.
2	Press  under SELECT.

About Datebook Events

Each Datebook event may contain the following information:

- The title you assign to the event. You can enter a title using the phone’s alphanumeric keypad or choose from a list of commonly used titles. A title is required for every event (maximum of 128 characters).
- Additional text following the event’s title.
- The start time and duration of the event.
- The date of the event.
- An option to repeat the event in your Datebook.
- An alarm to notify you of the event before it begins.
- The style you want your phone to use when the event occurs. See “Styles” on page 129 for more information.



Adding New Events

Using the following instructions, you will enter the information in the order the items appear on the **Event Form** screen. However, you can enter this information in any order by pressing  to scroll through the items on the **Event Form** screen. You can leave any item blank or unchanged by pressing  to scroll past it on the **Event Form** screen. Only a title and a date are required for a valid event.



To cancel a Datebook event entry at any time, press  to return to the **Ready** screen.

To add a Datebook event:

1 Access the **Event Form** screen:

While viewing a week in the Datebook, press  to access the **Datebook Menu**. Press  to scroll to **New**. Press  under **SELECT**.

Or,

While viewing a day, press  to scroll to **[New Event]**. Press  under **SELECT**.

The **Event Form** screen displays with the **Title** field highlighted.

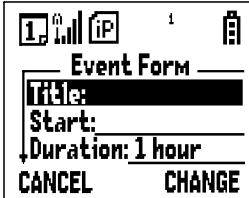

The screenshot shows the 'Event Form' screen. At the top, there are icons for a calendar, signal strength, IP address, and a battery level indicator. Below these is the title 'Event Form'. The form contains three input fields: 'Title:' (which is highlighted with a black background), 'Start:', and 'Duration: 1 hour'. At the bottom of the screen, there are two buttons: 'CANCEL' and 'CHANGE'.

2 With the **Title:** field highlighted, press under **CHANGE** to access the **Title:** screen.

3 Assign a title to the event:

Press **◂** under BROWSE to choose from a list of commonly used event titles. Press **⏪** to scroll to the title you want and press **◂** under SELECT.

Or,

Type the title using the alphanumeric keypad. See “Using T9® Text Input” on page 26 for information about entering text into this field.

You can also enter a description of the appointment or any other text.

When you are finished, press **◂** under OK.

The **Event Form** screen returns with the **Start:** field highlighted.

4 If you want to assign a time of day to the event:

With the **Start:** field highlighted, press **◂** under CHANGE.

From the **Start:** screen, enter the time the event will begin.

Type in the start time, or press **⏪** to scroll through the hours, minutes, and am, pm, or 24 hour clock. Press **⏩** or press **◂** under --> to move through the fields.

Press **◂** under DONE.

The **Event Form** screen returns with the **Duration:** field highlighted.

5 After you have assigned a start time to the event, you can specify the duration of the event. The default duration is one hour. To assign a different duration:

With the **Duration:** field highlighted, press **◂** under CHANGE.

From the **Duration** screen, press **⏪** to scroll to the desired duration. If you select **None**, the event will have a duration of zero minutes.



Press **◂** under SELECT.

The **Event Form** screen returns with the **StartDate:** field highlighted.

- 6** The default date assigned to an event is the day that was highlighted when you accessed the **Event Form** screen to add the event. To assign a different date:

With the **StartDate:** field highlighted, press  under CHANGE.

From the **StartDate:** screen, enter the date of the event:

Type in the date, or press  to scroll through the months, days, and years. Press  or press  under --> to move through the fields.

Press  under DONE.

The **Event Form** screen returns with the **Repeat:** field highlighted.

- 7** If you want the event to recur in your Datebook, assign a repeat cycle to it:



With the **Repeat:** field highlighted, press  under CHANGE.

NOTE: When Repeat is set to none or yearly, it will not be possible to access the Repeat End field.

From the **Repeat** screen, press  to scroll to the desired repeat cycle.

Press  under SELECT.

The **Event Form** screen returns with the **RepeatEnd:** field highlighted.

Press  under CHANGE and enter the date on which you want the event to stop repeating. When you have finished, press  under DONE.

The **Event Form** screen returns with the **Alarm:** field highlighted.

- 8 If you want to set an alarm to remind you that the event is approaching:

With the **Alarm:** field highlighted, press  under CHANGE.

From the **Alarm** screen, press  to scroll to the desired alarm option.

Press  under SELECT.

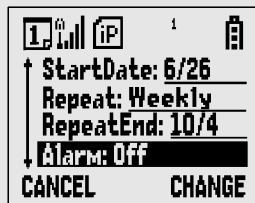

- 9 If you want your phone to change to a style you have defined when the event occurs (see “Styles” on page 129):

With **MORE** highlighted, press  under SELECT. The **Style:** field appears.

Press  under CHANGE.

From the **Style** screen, you see a list of styles you have created. Press  to scroll to the desired style.

Press  under SELECT.

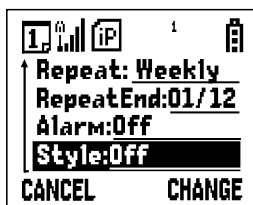

- 10 When you have entered all the desired information about the event, press  under DONE.







Editing Events

- 1 If you are viewing the event:

Press  under EDIT.

Or,

If you are viewing the day containing the event:

Press  to scroll to the event you want to edit. Press  to display the **Datebook Menu**. Press  to scroll to **Edit** and then press  under SELECT.

- 2 Follow the applicable instructions in “Adding New Events” on page 95, to edit the various fields.

Deleting Events

- 1 View the day containing the event and press  to scroll to the event you want to delete.

Or,

View the details of the event you want to delete.

- 2 Press . The **Datebook Menu** displays.

- 3 Press  to scroll to **Delete** and press  under SELECT.

- 4 If the event is a recurring event, the **Delete Event** screen appears:

- To delete only the occurrence of the event you select in step 1, leave **This Event Only** highlighted.
- To delete all occurrences of the event, press  to highlight **Repeat Events**.

Press  under SELECT.

- 5 If the event is a recurring event, a confirmation screen appears. Press  under YES to confirm.

Datebook Event Reminders

If you have set an alarm to remind you that a Datebook event is approaching, your phone sounds an audible alarm and displays a reminder on its screens.

When a Datebook event reminder appears on the full-sized screen:

Press  under VIEW to view more information about the Datebook event.

Or,

Press  under EXIT to dismiss the event reminder.





Customizing Datebook Set Up

Datebook allows you to customize some of its set up features:

- **DailyBegin** — sets the beginning time of the 12-hour day your Datebook displays when you are viewing a week.
- **Reminder** — controls the behavior of alarms you have set in Datebook:
 - **Active Only** sets Datebook to ignore alarms that occur when your phone is powered off.
 - **Delayed If Off** sets Datebook to delay alarms that occur when your phone is powered off until your phone is next powered on.
- **Weekday** — sets the first day of the week your Datebook displays when you are viewing a week.
- **DeleteAfter** — controls how long your Datebook waits to delete an event after it has occurred.

To customize your Datebook set up:

- 1 While viewing a week in the Datebook, press  to access the **Datebook Menu**.

2 Press  to scroll to **Setup** and then press  under SELECT

3 Press  to scroll to any of the set-up features.

Press  under CHANGE.

Use the screens that appear to make your changes.





Memo

The Memo application provides you with a place to store a numeric note (for example a phone number) in your *i80s* phone.





This section includes:

Adding a New Memo	Page 103
Viewing a Memo	Page 103
Editing a Memo	Page 104
Deleting a Memo	Page 104







Adding a New Memo

1	From the Ready screen, press  .
2	Press  to scroll to Memo .
3	Press  under SELECT. The Memo screen displays.
4	Type your numeric memo using the phone's keypad.
5	Press  under STORE.





Viewing a Memo

1	From the Ready screen, press  .
2	Press  to scroll to Memo .
3	Press  under SELECT.
4	To call this number, press  .

Editing a Memo

1	From the Ready screen, press  .
2	Press  to scroll to Memo .
3	Press  under SELECT.
4	Type the new number. You can delete a digit by pressing  under DELETE. To all the digits, press and hold  under DELETE.
5	Press  under STORE.

Deleting a Memo

1	From the Ready screen, press  .
2	Press  to scroll to Memo .
3	Press  under SELECT.
4	Press and hold  under DELETE.
5	Press  under STORE.

Java Apps

The Java Apps feature of your *i80s* phone runs programs, or applications, written in the Java programming language. Some Java applications are pre-loaded and ready to run.

You can download, install, and run other Java applications by loading them into your phone via the Internet.



NOTE: Downloadable custom Java applications may not be available for all customers. Contact your service provider for availability.

This section includes:

Accessing Java Applications	Page 105
Running Java Apps	Page 106
Downloading Java Applications	Page 106
Installing Java Applications	Page 107
Java Apps Memory	Page 107
Deinstalling Java Applications	Page 108

Accessing Java Applications



To access the Java applications:

- | | |
|----------|---|
| 1 | From the Ready screen, press  . |
| 2 | Press  to scroll to Java Apps . |
| 3 | Press  under SELECT . |

The **Java Apps** screen displays all your Java applications.

Running Java Apps

To run an application:

- 1 From the **Java Apps** screen, press  to scroll to the application you want to run.
- 2 Press  under RUN or SELECT.



To suspend a running application:

Press .

To resume a suspended application:

Press  under RESUME.

To stop running an application:

Press  and then press  under EXIT.

Downloading Java Applications

You can customize your phone by connecting your phone to a PC using a data cable and downloading additional Java applications. Please go to www.motorola.com/idenupdate for a selection of applications and downloading instructions.



Installing Java Applications

Before running a Java application you have downloaded, you must install it.

To install a Java application:

- | | |
|----------|---|
| 1 | From the Java screen, press  to scroll to the application that you want to install.





If the display option is RUN or SELECT, the application is already installed and ready to run. See “Running Java Apps” on page 106.

If the display option is INSTALL, press  under INSTALL to install the application. |
| 2 | Press  under INSTALL. |
| 3 | When your phone has finished installing the application, press  under DONE. |

Java Apps Memory

If you want to use custom Java applications in your phone, you must have enough memory in your phone to store and run the custom application you want. If you do not have enough memory, you can uninstall an application or delete a Voice Note (see “Deleting Voice Notes” on page 112) to free up memory.

To check how much memory your phone has available for Java applications:

- | | |
|----------|---|
| 1 | From the Java Apps screen, press  to scroll to Java System . |
| 2 | Press under  SELECT. |
| 3 | Press  under NEXT. |
| 4 | To see more memory information, press  under NEXT again. |







The screens displayed show how much **Data** and **Program** memory your phone has free:

- **Data** refers to the memory used to store application data, such as image files.

- **Program** refers to the memory used to install application code.

Deinstalling Java Applications

To remove a Java application from your phone:

1	From the Java Apps screen, press  to scroll to the application you want to remove.
2	Press  .
3	Press  to scroll to DEINSTALL.
4	Press  under SELECT.
5	A confirmation screen displays. Press  under YES.
6	When your phone has finished deinstalling the application, press  under DONE.

NOTE: Because Java applications are stored in your phone using the same memory space used to store Voice Notes, using a large amount of memory to store Voice Notes reduces the space available for Java applications. When this occurs, deleting Voice Notes from your phone's memory frees memory space for Java applications. For more information about Voice Notes stored in your phone, see "Customizing the i80s Phone" on page 115.

 <p>WARNING</p>	<p>To avoid personal injury, do not play games on your i80s phone when operating machines or driving vehicles.</p>
---	--

Voice Notes

The Voice Notes feature enables you to record and play back personal messages or the incoming portion of phone calls on your *i80s* phone.

This section includes:



About Voice Notes	Page 109
Accessing Voice Notes	Page 109
Recording a Voice Note	Page 110
Playing a Voice Note	Page 110
Adding to a Voice Note	Page 111
Labeling a Voice Note	Page 111
Deleting Voice Notes	Page 112
Locking/Unlocking a Voice Note	Page 112
Voice Notes Memory	Page 113

About Voice Notes

Your phone can store up to 20 Voice Notes, with a total time of about three minutes, depending on available memory.

Accessing Voice Notes



To access the Voice Notes feature:

1	From the Ready screen, press  .
2	Press  to scroll to VoiceNotes .
3	Press  under SELECT .





Recording a Voice Note

NOTE: Recording of phone calls is subject to varying State and Federal laws regarding privacy and recording of phone conversations.



To record a personal message as a Voice Note:

- | | |
|----------|---|
| 1 | From the VoiceNotes screen, press  to scroll to [New VoiceNote] . |
| 2 | Press  under RECORD and speak the message you want to record into the microphone. |
| 3 | When you are finished recording your Voice Note, press  under STOP . |

To record the incoming portion of a call as a Voice Note:

- | | |
|----------|--|
| 1 | While on an active call, press  . |
| 2 | Press  to scroll to Record . |
| 3 | Press  under SELECT to record the incoming portion of the call. Your own voice will not be recorded. |
| 4 | When you are finished recording your Voice Note, press  under STOP . |





Playing a Voice Note

- | | |
|----------|--|
| 1 | From the VoiceNotes screen, press  to scroll to the Voice Note you want to play. |
| 2 | Press  under PLAY . |
| 3 | To stop the Voice Note while it is playing, press  under BACK . |

NOTE: Voice Notes are heard through the speaker.

Adding to a Voice Note





After you create a Voice Note, you can record more at the end of the existing Voice Note:

1	From the VoiceNotes screen, press  to scroll to the Voice Note you want to add to.
2	Press  to view the VoiceNotes Menu .
3	Press  to scroll to Add To .
4	Press  under SELECT and speak the message you want to record into the microphone.
5	When you are finished recording, press  under STOP.

Labeling a Voice Note





When you create a Voice Note, it is labeled with the time and date it was recorded. After a Voice Note has been recorded, you can re-name it with a custom label.

To label a Voice Note:





1	From the VoiceNotes screen, press  to scroll to Voice Note you want to name.
2	Press  to view the VoiceNotes Menu .
3	Press  to scroll to Label and press  under SELECT.
4	At the Enter Label: screen, enter a label for the Voice Note using the alphanumeric keypad.
5	Press  under OK.

Deleting Voice Notes

To delete a Voice Note:

- | | |
|---|--|
| 1 | From the VoiceNotes screen, press  to scroll to the Voice Note you want to delete. |
| 2 | Press  to view the VoiceNotes Menu . |
| 3 | Press  to scroll to Delete and press  under SELECT. |
| 4 | A confirmation screen appears. Press  under YES to confirm. |





To delete all unlocked Voice Notes:

- | | |
|---|--|
| 1 | From the VoiceNotes screen, press  to view the VoiceNotes Menu . |
| 2 | Press  to scroll to Delete All and press  under SELECT. |
| 3 | A confirmation screen appears. Press  under YES to confirm. |

Locking/Unlocking a Voice Note

Locking a Voice Note prevents it from being deleted. When a Voice Note is locked, the locked icon  appears next to it.

To lock or unlock a Voice Note:

- | | |
|---|--|
| 1 | From the VoiceNotes screen, press  to scroll to the Voice Note you want to lock or unlock. |
| 2 | Press  to view the VoiceNotes Menu . |
| 3 | Press  to scroll to Lock or Unlock . |
| 4 | Press  under SELECT. A confirmation screen displays. |

Voice Notes Memory

Typically, you can store 20 Voice Notes with a total time of about three minutes. To check the amount of memory available for Voice Notes:

1 From the **VoiceNotes** screen, press  to view the **VoiceNotes Menu**.

2 Press  to scroll to **Memory**.

3 Press  under **SELECT** to display the **Memory Meter** screen.

The memory meter shows the amount of Voice Notes memory space currently in use. It fills in from left to right as your Voice Notes memory space fills up.

4 From the **Memory Meter** screen, you can free more Voice Notes memory space by pressing  under **DELETE** to delete all unlocked Voice Notes.

A confirmation screen displays. Press  under **YES** to confirm.

NOTE: Because Voice Notes are stored in your phone using the same memory space used to store Java applications, using a large amount of memory to store Java applications reduces the space available for Voice Notes. When this occurs, deleting Java applications from your phone's memory frees memory space for Voice Notes. For more information about deleting Java applications stored in your phone, see "Deinstalling Java Applications" on page 108.

Customizing the i80s Phone

You can customize your i80s phone to fit the way you want to use it.



This section includes:

Settings	Page 115
Styles	Page 129
Shortcuts	Page 135

Settings

The phone's Settings menu enables you to control many of the phone's features and functions, including display properties, message handling, and security features.

To access the Settings menu:



1	From the Ready screen, press  .
2	Press  to scroll to Settings .
3	Press  under SELECT.



From the **Settings** screen, you can access these Settings options:

- **Ring/Vibe** — controls how your phone rings or vibrates (*VibraCall™*) when you receive calls and messages.
- **Phone Setup** — sets call-answering features, turns off non-telephone features, chooses which phone line is used, and sets your network ID.
- **In Call Setup** — sets call timer, message notification, and call waiting features.
- **Security** — sets security features including phone lock, keypad lock, and SIM PIN.
- **Personalize** — controls which features are most accessible when you turn on your phone.

- **Initial Setup** — sets a variety of display features including the language displayed, the screen contrast, time and date formats, current year, backlight, status light, and scrolling. Also turns auto redial on or off and sets baud rate.
- **VoiceVolume** — sets the volume of your phone's earpiece and speaker.
- **Tkgrp** — sets certain Talkgroup options.
- **Service Status** — shows the status of your phone's services.

To access any of these options:

- | | |
|---|--|
| 1 | From the Settings screen, press  to scroll to the option you want to access. |
| 2 | Press  under SELECT. |

Many of these options have other options within them. Press  to scroll through the lists of options, and press  to select and modify options and the features, according to the instructions on your phone's screen. For some options, you can also press  to select sub-options.

In screens that show lists of options for a setting, a check mark to the left of the option indicates the current option for the setting.

Ring/Vibe

Ring/Vibe enables you to control how your phone rings and vibrates VibraCall^{®*} when you receive calls and messages. You can set ring volume, choose ring styles, and use the vibrate alert feature which enables you to set your phone to alert you to calls and messages by vibrating.

Main Options

Ring/Vibe provides these main options:

- **Ringer Vol** — sets ring volume.
- **Keypad Vol** — sets volume of sounds associated with keypad actions.
- **Mail Vol** — sets volume of Text Message, Voice Mail, and Net Mail notifications.
- **Headset** — choosing the **HdsetOnly** option prevents sound from being emitted from the phone's speaker when the headset is being used.

- **VibeAll** (*VibraCall™*) — choosing **On** sets the phone to vibrate for all calls, messages, and alerts; choosing **Off** enables you set the type of notification for each these features.





Ring Style and Notification Type

When you set **VibeAll** to **On**, your phone vibrates to notify you of all types of calls, messages, and alerts.

When you set **VibeAll** to **Off**, the following features display after **VibeAll** on the **Ring/Vibrate** screen, enabling you to set notification options for each:



- **Line 1** — sets the ring style and type of notification for calls on Line 1.
- **Line 2** — sets the ring style and type of notification for calls on Line 2.
- **Pvt/Grp** — sets type of notification for private and group calls.
- **Call Alert** — sets the ring style and type of notification for call alerts.
- **Text Msgs** — sets type of notification for Text Messages.
- **Reminder** — sets type of notification for Datebook reminder alarms.
- **Voicemail** — sets type of notification for Voice Mail messages.
- **Netmail** — sets type of notification for Net Mail messages.

To set **VibeAll** to **Off** or **On**:

1	From the Ring/Vibrate screen, press  to scroll to the VibeAll :
2	Press  under CHANGE.
3	Press  to scroll to Off or On .
4	Press  under SELECT.

The following icons appear on your display screen to indicate the options you have chosen:





Icon	Indicates...
	Vibrate All - phone is set to vibrate when you receive all types of calls, messages, and alerts; the VibeAll option is On .

	Vibrate On - phone is set to vibrate when you receive phone calls.
	Vibrate Then Ring - phone is set to vibrate and then ring when you receive phone calls.
	Silent - phone is set not to ring.

Ring Styles

When you set a ring style, you can choose from any of nine pre-set ring styles.

To set a ring style:

1	From the Ring/Vibrate screen, ensure that VibeAll is set to Off . Then press  to scroll to any of the features that allow you to set a ringer style: Line1 , Line2 , or Call Alert .
2	Press  under SELECT .
3	With the Style: field highlight, press  under CHANGE .
4	Press  to scroll to the ring style you want to assign to the feature.
5	To assign the ring style, press  under SELECT .





USER TIP: To hear the ring style you have selected, press the volume button on the side of your phone.

Notification Types

When you set a notification type, you have these options:

- **Ring** — the phone rings to notify you.
- **Vibe** — the phone vibrates to notify you.
- **Vibe/Ring** — the phone vibrates and then rings to notify you. This option is only available for calls on Line 1 and Line 2.
- **Silent** — the phone does not ring to notify you.

To set a notification type:

1	From the Ring/Vibrate screen, ensure that VibeAll is set to Off . Then press  to scroll to any of the features on the Ring/Vibrate screen after VibeAll .
2	Press  under SELECT.
3	With the Type: field highlighted, press  under CHANGE.
4	Press  to scroll to the notification type you want to assign to the feature.
5	To assign the notification type, press  under SELECT.

Phone Setup

Phone Setup sets some basic phone features. Access Phone Setup to set the following options:

- **Line** — enables you to choose Line 1 or Line 2 as the active line for outgoing calls.
- **AutoAns** — sets your phone to automatically answer an incoming call after a specified number of rings. When this feature is turned on, the phone answers by connecting you to the caller; it does not send the call to Voice Mail, unless you are out of coverage or on the line.
- **Any Key** — when turned on, enables you to answer calls by pressing any key on the alphanumeric keypad.
- **Phone Only** — when turned on, prevents your phone from making or receiving Private calls or Group calls.
- **Network ID** — enables you to set the phone's network IDs and their roaming options.

In Call Setup

In Call Setup sets the in-call timer, message notification, and call-waiting features.

- The **In Call Timer** option turns the following features on and off:
 - **Display** — the duration of each call displays on the phone's screen.

- **Minute Beep** — an audible beep occurs every minute of an active call.
- The **Notifications** option controls message notification during calls:
 - **Receive All** — notifies you of all types of messages during calls.
 - **Msg Mail Only** — notifies you of mail messages only; all other types of message notifications are delayed until the call has ended.
 - **Delay All** — delays notification of all messages until the call has ended.
- **Call Waiting** — enables you to turn off call waiting for the next call. After you hang up, call waiting is turned back on.

Security

Security allows you to set security features:

- **Phone Lock** — sets an optional code that locks your phone.
- **Keypad Lock** — displays instructions for locking and unlocking your phone's keypad.
- **SIM PIN** — enables and disables your phone's SIM PIN requirement.
- **New Passwords** — enables you to change your phone's security code, phone unlock code, and SIM PIN.
- **Master Reset** — allows your service provider to reset your service in the event of a security or provisioning problem.

Using Phone Lock

The Phone Lock feature enables you to prevent your phone from being used unless an Unlock code is typed into the keypad.

The Unlock code is required to enable the phone lock feature, to unlock the phone, and to set a new Unlock code. Contact your service provider for your default Unlock code.

Phone lock provides two options for locking the phone:

- **Lock Now** locks the phone immediately after you set the option.
- **Auto Lock** locks the phone the next time the phone is powered on.

Setting Keypad Lock

Choosing the Keypad Lock option displays instructions for locking and unlocking your phone's keypad. See "Keypad Lock" on page 21 for more information on locking the keypad.

Enabling and Disabling SIM PIN

The SIM PIN option enables and disables the feature that requires a SIM PIN code to be typed into the phone to access the information on the SIM card and to make or receive calls. See "SIM Card Personal Identification Number (PIN)" on page 15 for more information.

Setting New Passwords

The New Passwords option enables you to set three types of passwords that control access to your phone:

- **Unlock Code** — this code is used to control access to the phone using Phone Lock. It is also required to access the Master Clear and Feature Reset features. If you want to use any of these features, contact your service provider for your default Unlock code.
- **Security Code** — this code is used to access the Master Reset feature under the direction of your service provider. It can also be used to override your Unlock code under the direction of your service provider.
- **SIM PIN** — this code is used to access the information on your SIM card and to make or receive calls. When you get your phone, your SIM PIN is 0000. You should change this to a SIM PIN known only to you as soon as you get your phone. For information on changing your SIM PIN, see "Changing the PIN" on page 16.

Using Master Reset

The Master Reset option is provided for use only under the direction of your service provider. It resets your service.







Personalize

Personalize contains three options that control which major features are easiest to access when you turn on your phone:

- **Main Menu** — changes the order of the items on your main menu.
- **Keys** — controls which main menu items appear above the two option keys on the **Ready** screen.

- **Power Up App** — sets any of the programs on the main menu to run when you turn on your phone.





Reordering Main Menu

1	From the Personalize screen with Main Menu highlighted, press  under SELECT to access the Reorder Menu screen.
2	Press  to scroll to the main menu option you want to move.
3	Press  under GRAB.
4	Press  to move the option up or down in the list.
5	When the item is where you would like it to appear in the main menu, press  under INSERT.
6	Repeat step 2 through step 5 for all main menu items you want to move.
7	Press  under DONE.



Changing Ready Screen Options

Two options from the main menu always appear on your **Ready** screen above the left and right option keys. Each option can be accessed by pressing the corresponding option key.

Your phone arrives with Phonebook (PHBK) assigned to the left option key and Messages (MESG) assigned to the right option key (). You can assign any Main Menu option you want to the option keys.

1	From the Personalize screen, press  to scroll to Keys .
2	Press  under SELECT. The Keys screen shows the option assigned to each option key (Left and Right).
3	To change the option assigned to the left option key, press  under CHANGE while Left is highlighted.
4	Press  to scroll to the option you want to assign to the left option key.

5 Press  under SELECT.

6 To change the option assigned to the right option key, press  to highlight **Right** and press  under CHANGE. Repeat steps 4 and 5 for the right option key.

Changing Power-Up Program

Your phone is set to display the **Ready** screen when it is powered on. You can set the phone to display the main screen of any main menu option when it is powered on.

1 From the **Personalize** screen, press  to scroll to **Power Up App**.

2 Press  under SELECT. The **Power Up App** screen shows the name of the program or screen that currently appears when the phone is powered on.

3 Press  under CHANGE.

4 Press  to scroll to the option you want to appear when the phone is powered on.

5 Press  under SELECT.

Initial Setup

Initial Setup enables you to control a variety of your phone's features that you may want to modify when you first get your phone:

- **Time/Date Format** — sets the format in which the time and date display on your phone.
- **Year** — sets the current year.

NOTE: Changing the current year may affect stored Datebook events. Datebook stores events 12 months ahead and one month before the current date. Events outside this range will be deleted. See "Datebook" on page 91 for more information.

- **Auto Redial** — turns the automatic redial feature on and off.
- **Backlight** — controls how long your phone's backlight stays on.

- **Status Light** — controls whether the status light is on when the phone is on.
- **Scroll** — sets how you can scroll lists and menus.
- **Language** — sets the language that your phone displays.
- **Master Clear** — returns all settings to their original defaults and erases all stored lists. Use only under the direction of your service provider.
- **Feature Reset** — returns all settings to their original defaults. Use only under the direction of your service provider.
- **Baud Rate** — sets the baud rate at which your phone communicates when connected to a laptop computer, PC, or similar device.
- **TTY Setup** — sets TTY options. By default, your phone is set to function with a TTY device.
- **TTY Baud Rate** — sets the baud rate at which your phone communicates when connected to a TTY device.

Changing Time and Date Format

Your phone displays times in 12-hour-clock format (12:00 am through 11:59 pm) or 24-hour-clock format (0:00 through 23:59). It displays dates in month/day format or day/month format.

NOTE: If you turn the time and date display off, no times are associated with calls on your Recent Calls list, and the alarm feature of your Datebook is disabled.

To set the time and date format, or turn time and date display on or off:

1 From the **Initial Setup** screen with **Time/Date Format** highlighted, press  under SELECT to access the **Time/Date Format** screen.



2 To change the time format:

With **Time Format**: highlighted, press  under CHANGE to access the **Time Format** screen.

Press  to highlight the time format you want.

Press  under SELECT.



3 To change the date format:

Press  to highlight **Date Format**, and press  under CHANGE to access the **Date Format** screen.

Press  to highlight the date format you want.

Press  under SELECT.

4 To turn the time and date format on or off:

Press  to highlight **Display**, and press  under CHANGE to access the **Display** screen.

Press  to choose **Off** or **On**.

Press  under SELECT.

Setting Auto Redial

When Auto Redial is set to **On**, if you receive a **System Busy, Try Later** message while making a call, the phone will redial the number automatically. You will hear a ring-back tone when a successful call is placed.

When Auto Redial is set to **Off**, you must press and hold  to redial the last number dialed.

Setting Backlight Timer

The backlight illuminates the display when you receive or make calls. You can set the amount of time that the backlight stays on to 5, 10, 20, or 30 seconds, or set it to stay on continuously or stay off at all times.

1 From the **Initial Setup** screen, press  to scroll to **Backlight**.

2 Press  under CHANGE.

3 Press  to scroll to the desired backlight option.

4 Press  under SELECT.

NOTE: Setting the backlight to stay on continuously will decrease the amount of time you can use the phone before recharging the battery.

Adjusting Status Light

The status light is located on the top of the phone. It illuminates when the phone is on. See “Status of Your i80s Phone” on page 24. You can turn the status light feature on or off from the **Initial Setup** screen.

Setting Scrolling

You can set your phone to scroll through menus and lists in either of two ways:





- **Up/Down** — when you reach the bottom or top of list or menu scrolling stops until you scroll in the other direction.
- **Wrap Around** — when you reach the bottom or top of a list or menu scrolling “wraps” around and continues at the other end of the list or menu.

You can set the scrolling style from the **Initial Setup** screen using the **Scroll** option.

Changing Display Language

You can customize the i80s phone to display menus in English, French, Spanish, or Portuguese. The default language is English.

To change the display language:

1	From the Initial Setup screen, press  to scroll to Language .
2	Press  under CHANGE.
3	Press  to scroll to the language you want your phone to display.
4	Press  under SELECT.

Master Clear

Master Clear returns all your phone’s settings to their original defaults and erases all stored lists. To use this feature, you must contact your service provider to receive your phone’s Unlock code.

Feature Reset

Feature Reset returns all your phone's settings to their original defaults. To use this feature, you must contact your service provider to receive your phone's Unlock code.

Setting Baud Rate

You can set your phone's baud rate from the **Initial Setup** screen. Scroll to the **Baud Rate** option and then choose the baud rate you want, or choose **Auto** to set your phone to automatically choose the appropriate baud rate.

Setting TTY Mode





TTY Setup enables you to set your options for using your phone with a teletypewriter (TTY) device. By default, your phone is set to function with a TTY device in TTY mode.

Your phone supports the following TTY modes:

- **TTY** — for calls in which you type and read text on your TTY device.
- **VCO (Voice-Carry-Over)** — for calls in which you speak into your phone and read text replies on your TTY device.
- **HCO (Hearing-Carry-Over)** — for calls in which you type text on your TTY device on listen to voice replies on your phone's speaker.

You can set your TTY mode using your phone's **Settings** menu at any time, or by issuing commands from your TTY device while on an active call.

To set your phone's TTY mode using your phone's **Settings** menu:

1	From the Initial Setup screen, press  to scroll to TTY Setup .
2	Press  under CHANGE.
3	Press  to scroll to the desired TTY mode; Off , TTY , VCO , or HCO .
4	Press  under SELECT.

To set your phone's TTY mode from your TTY device, issue one of the following commands while on an active call:

- “VCO please” — to select VCO mode.

- “HCO please” — to select HCO mode.
- “HCO off please” — to turn off HCO mode.





 <p>WARNING</p>	<p>When you are using HCO, the sound coming from your phone speaker may be uncomfortably loud. Use caution when putting the phone to your ear. (For information on setting your phone's speaker volume, see “VoiceVolume” on page 128.)</p>
---	---

NOTE: TTY device manufacturer's proprietary feature such as Turbo-Code, High-Speed, and Interruption are not supported by your phone. These features must be turned off or disabled to use your TTY device with your phone.

Setting TTY Baud Rate



By default, your phone's TTY baud rate is set to 45.45, the baud rate required for TTY calls within the US. To make calls outside the US, set your TTY baud rate to 50.0.

To change the TTY baud rate:

1	From the Initial Setup screen, press  to scroll to TTY Baud .
2	Press  under CHANGE.
3	Press  to scroll to the baud rate for your location.
4	Press  under SELECT.

VoiceVolume

VoiceVolume sets the volume of the sound coming from your phone's earpiece or speaker:

1	From the VoiceVolume screen, highlight Earpiece Vol: to set the earpiece volume, or press  to scroll to Speaker Vol: to set the speaker volume.
2	Press  under CHANGE.

3 To select a volume level:

Press  to raise or lower the volume setting.

Or,

Press the Volume Control buttons on the side of your phone.

4 Press  under OK.

Tkgrp (Talkgroup) Settings

Tkgrp Settings enables you to set certain Talkgroup options. See “Group Call” on page 87 for more information.

Service Status

The Service Status screen shows the status of your phone’s services. This screen is for information only; no options can be set.

Styles

This feature enables you to save a group of settings for call and message notifications, screen display, and call answering features. You save your selections as a “style” and access them at any time. You can use pre-set styles, such as Car & Meeting, or you can edit them or create your own styles. You can store up to ten styles.

The Styles feature enables you to save a group of settings for call and message notification, screen display, and call answering features. You save your selections as a “style” and access them at any time. You can store up to ten styles.

You may want to use this feature to create a style for use in your car, or in meetings, for example.



Each style contains the following settings:

- **Ring/Vibe** — controls how your phone rings and vibrates when you receive calls and other messages. See “Ring/Vibe” on page 116.
- **Backlight** — controls how long your phone’s backlight stays on. See “Setting Backlight Timer” on page 125.

- **Call Filter** — enables you to set your phone to not ring or vibrate when you receive some of all calls, messages, and alerts. See “Setting Call Filtering” on page 133.
- **Auto Answer** — sets your phone to automatically answer an incoming call after a specified number of rings. When this feature is turned on, the phone answers by connecting you to the caller; it does not send the call to Voice Mail.

Using the Styles feature, you can create styles, edit styles, view a style’s properties, delete styles, activate any style you have created, or turn off the active style.

To access the **Styles Menu**:

1	From the Ready screen, press  .
2	Press  to scroll to Styles .
3	Press  under SELECT.



From the **Styles Menu**, you can:

- activate a style or turn off the currently active style
- create a new style
- access the **Styles Action** menu for more Styles functions

Creating a Style



When you create a style, you give it a name and set the features of that style. The name of the style then appears on the Styles Menu.

To create a style:

1	From the Styles Menu screen, press  to scroll to [New Style] .
2	Press  under SELECT.

3 Assign a name to the style you are creating:

In the **Name:** screen, use the alphanumeric keypad to enter the name you want to give the style.

As you type, you can delete a letter by pressing  under DELETE. To create a space, press  once.

Press  under OK.

4 In the **New** screen, press  to scroll through the settings for each style option.

5 To change any style option:

Press  to highlight the option.

Press  under CHANGE or SELECT.

Use the screens that appear to make your changes.

6 When all the style options have the settings you want, press  under DONE.

Editing a Style

To change the settings of a style:

1 From the **Styles Menu** screen, press  to scroll to the name of the style you want to edit.

2 Press  to access the **Styles Action** menu.

3 Press  to scroll to **Edit** and press  under SELECT.

4 To change any style option:

Press  to highlight the option.

Press  under CHANGE or SELECT.

Use the screens that appear to make your changes.

5 When all the style options have the settings you want, press  under DONE.

Activating a Style

When you access the **Styles Menu**, a check mark appears to the left of the name of the style that is currently active on your phone. If no style is active, the check mark appears next to **Off**.

To activate a style:

1 From the **Styles Menu** screen, press  to scroll to the name of the style you want to activate.

2 Press  under SELECT.

The style immediately becomes active on your phone.

Turning Off a Style

To turn off a style without activating another style:

1 From the **Styles Menu** screen, press  to scroll **Off**.

2 Press  under SELECT.

Using the Styles Actions Menu

When you highlight a style on the Styles Menu, you can then access the **Styles Actions** menu for additional Styles functions.

To access the **Styles Actions** menu, press  from the Styles menu.

The Styles Actions menu provides the following options:

- **View** — view settings of the highlighted style.
- **Change** — activate the highlighted style.
- **Edit** — edit the settings of the highlighted style.
- **New** — create a new style.
- **Delete** — delete the highlighted style.
- **Delete All** — delete all styles.

Setting Call Filtering

The Call Filter feature enables you to control which calls, messages, and alerts your phone responds to, and which it ignores.

From the **Call Filter** screen, you set separate filtering options for phone calls, private and group calls, alerts, and messages:









- **Phone** — sets filtering options for phone calls.
- **Prvt/Grp** — sets filtering options for Private and Group calls.
- **Alerts** — sets filtering options for call alerts.
- **Notifications** — sets filtering options for messages.

Setting Phone Call Filtering

Call Filter enables you to set your phone to respond to all calls, no calls, or only calls from some or all numbers in your Phonebook:

- **Off** sets your phone notify you of all calls.
- **All** sets your phone to ignore all calls.
- **All Phonebook** sets your phone to notify you only of calls from the numbers stored in your Phonebook.
- **Some Phonebook** sets your phone to notify you only of calls from numbers you select from your Phonebook. You may choose up to five Phonebook entries.

To choose Phonebook entries that you want your phone to respond to calls from:

1	From the Call Filter screen, press  to scroll Phone: .
2	Press  under CHANGE.
3	Press  to scroll to Some Phonebook .
4	Press  under SELECT. The entries stored in your Phonebook appear.
5	To select a Phonebook entry as one you want to your phone to respond to, press  to scroll to the Phonebook entry and press  under SELECT. A check mark appears next to each selected Phonebook entry. You may select up to five Phonebook entries.
6	To remove a selected Phonebook entry from the list, press  to scroll to the name and press  under SELECT.
7	When you have selected the Phonebook entries you want, press  under DONE.

Setting Private and Group Call Filtering

Setting **Prvt/Grp** to **On** sets your phone to ignore all Private and Group calls. Setting **Prvt/Grp** to **Off** sets your phone to respond to all Private and Group calls.

Setting Alert Filtering

Setting **Alerts** to **On** sets your phone to ignore all call alerts. Setting **Alerts** to **Off** sets your phone to respond to all call alerts.

Setting Message Notification Filtering

Call Filter enables you to set your phone to notify you of some types of messages, all types of messages, or no messages:

- **Off** allows your phone to notify you of all messages.
- **Voice Messages** allows your phone to notify you of Voice Mail messages.
- **Text Messages** allows your phone to notify you of Text Messages messages.
- **All** prevents your phone from notifying you of all messages.



Call Filter can prevent your phone from ringing or vibrating when you receive a message. Your display screen will still indicate that you have messages.

Shortcuts

The Shortcuts feature enables you to access most menu or sub-menu options in your phone by pressing a numeric button on the keypad or speaking a voice name for the shortcut. You create the shortcut to the menu by assigning a number to it and then accessing the menu by pressing the number.

Creating a Shortcut

- 1 Navigate to the menu item to which you want to create a shortcut. For example, if you wanted to create a shortcut to **Ring/Vibe**:

From the **Ready** screen, press , then press  to scroll to **Setting**. Press  under SELECT. **Ring/Vibe** is now highlighted in the **Settings** screen.

- 2 Press and hold  for about 2 seconds.

3 A confirmation screen displays showing the name of the menu item to which you want to create a shortcut. To proceed with assigning the shortcut, press  under YES.

4 A screen displays showing the assigned shortcut number.

If you want to change the shortcut number:

Press  under CHANGE.

Press  under DELETE to erase the assigned number.

Enter the desired number on your keypad and press  under OK.

Using a Shortcut

To use a shortcut to access a menu:

1 From the **Ready** screen, press .

2 Press the number assigned to the shortcut. You have 2 seconds to do this after pressing .

Or,

1 From the **Ready** screen, press .

2 Press  to scroll to **Shortcuts**.

3 Press  under SELECT.

4 Press  to scroll to the shortcut you want to use.

5 Press  under GOTO.

Or, if you have assigned the shortcut a voice name:

- 1 From the **Ready** screen, press and hold  on the top of your phone until the **Say Name Now** screen appears.
- 2 Say the voice name assigned to the shortcut into your phone's microphone.





Your phone will play the voice name back to you.

Using the Shortcut Menu

The Shortcut Menu enables you to manage your shortcuts with the following options.

- **New** — view instructions for assigning a shortcut.
- **Edit** — edit a shortcut name and key number.
- **Reorder** — assign existing shortcuts to a different key number.
- **Delete** — delete any highlighted Shortcut.
- **Delete All** — delete all stored Shortcuts.

To access the **Shortcut** menu:

- 1 From the **Ready** screen, press .
- 2 Press  to scroll to **Shortcuts**.
- 3 Press  under **SELECT**.
- 4 Press  to scroll to the desired shortcut.
- 5 Press .

Accessories

To order additional accessories, log on to our Web site at: www.motorola.com/store/iden or contact your Motorola Authorized Retailer.

This section includes the following topics:

Carrying Solutions	Page 139
Batteries	Page 142
Travel Chargers	Page 143
Data Accessories	Page 145
Data Accessories	Page 145

Carrying Solutions

Swivel Carry Clip

The Swivel Carry Clip provides a convenient means by which to carry your *i80s* phone with you. It consists of the Phone Clip and the Belt Clip.

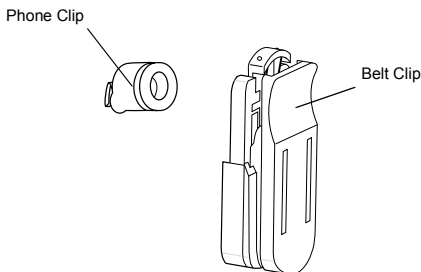

Using the Swivel Carry Clip

- 1 Ensure that the phone is **powered off** before attempting to detach the battery.

- 2 Attach the Phone Clip to the phone by removing the battery.

Holding the phone face down, remove the battery by sliding the battery release button backwards, while lifting in an upward and outward motion.

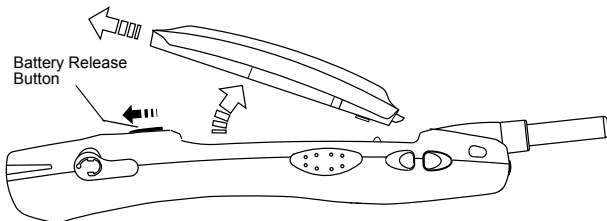

- 3 Slide the Phone Clip under the slotted lip and reattach the battery..

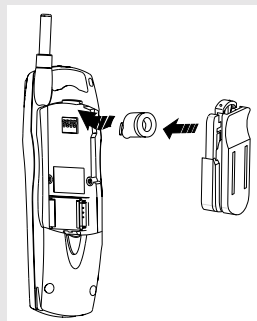

- 4 Slide the Phone clip into the belt clip until a secure click is heard.

Removing the Swivel Carry Clip

1 Ensure that the phone is **powered off** before attempting to detach the battery.

2 Holding the phone face down, remove the battery by sliding the battery release button backwards, while lifting in an upward and outward motion.

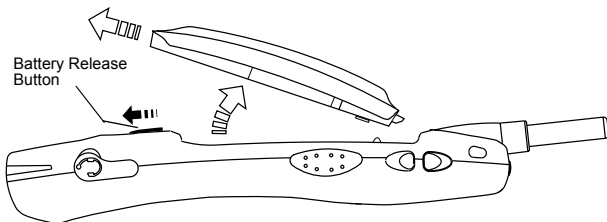

3 Slide the Phone clip in a downward motion. This will unclip the assembly from the phone..

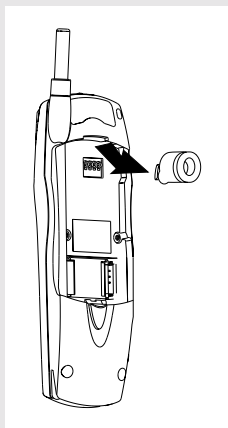

Batteries

For best results, charge the batteries within the temperature range of 10°C to 40°C (50°F to 104°F).

Prolonged charging is not recommended. For battery charging guidelines, see Table below.

Charging Lithium Ion Batteries

Table 2 provides the approximate time to fully charge a battery using a Motorola iDEN Approved Lithium Ion battery charger. Check the kit number on your battery and charger to determine the appropriate charging time.

Table 2: Battery Charging Times

MOTOROLA BATTERIES		Charging Time to 100%		
Item Number	Description/ Chemistry	Single Voltage Charger (SPN4808)	Rapid Charger (NTN4716)	Multi Voltage Charger (SPN4940)
NTN9809 NTN9958	Slim Li Ion Battery	2 hrs 30 min	2 hours	2 hrs 30 min
NTN9810 NTN9959	High Performance Li Ion Battery	4 hours	2 hrs 30 min	4 hours

NOTE: Charging times are based on a fully discharged battery.

For optimal battery life, use a Motorola iDEN Approved Lithium Ion battery charger with your Motorola iDEN Lithium Ion battery. Other chargers may not fully charge your Lithium Ion battery.

Battery Operating Instructions

- Extreme temperatures will degrade battery performance. Do not store your battery where temperatures exceed 60°C (140°F) or fall below -20°C (4°F).
- Lithium Ion batteries have a self discharge rate and without use, will lose about 1% of its charge per day.

- The battery capacity will be degraded if stored for long periods while fully charged. If long term storage is required, store at half capacity.
- The Motorola iDEN Approved Lithium Ion chargers will provide optimum performance. Other chargers may not fully charge your iDEN Lithium Ion battery or may yield reduced number of lifetime charge cycles.
- If the battery appears inoperative, the internal protection circuitry may have been activated. Remove the battery from the phone and put it into the charger for several minutes to reset the circuitry.
- When batteries are not in use, always store them in the plastic safety tray.

Travel Chargers

Using one of the Travel Chargers listed below, you can charge a battery from an AC outlet. On one end of the Travel Charger, an accessory connector attaches to the bottom of the phone. At the other (AC outlet) end of the device, there is a compact housing that contains the plug-in power supply.

TRAVEL CHARGERS	
Item Number	Description
SPN4940	Multi-Voltage Travel Charger
SPN4716	Rapid Multi-Voltage Travel Charger
SPN4808	Mid-Rate Economy Travel Charger

NOTE: Additional adaptor plugs to accommodate various International power outlets can be purchased separately for the multi-voltage Travel Chargers.

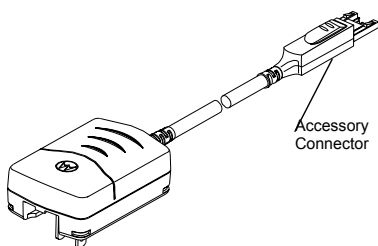

Rapid Travel Charger

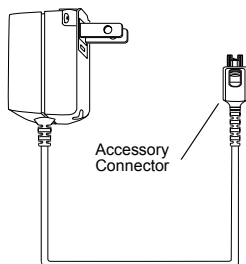

Economy Travel Charger

Using the Travel Charger

- 1 While holding the phone with its keypad facing up, insert the accessory connector (with the Motorola logo facing you) into the bottom of the phone until you hear a click.
- 2 If you have either the Mid-Rate Multi-Voltage Travel Charger or the Rapid Multi-Voltage Travel Charger, flip open the prongs, and plug the Travel Charger transformer into an AC wall outlet.

Or

If you have the Mid-Rate Economy Travel Charger, plug the Travel Charger transformer into an AC wall outlet.

Data Accessories

The RS232 Data Cable facilitates quick and easy data synchronization between your *i80s* phone and a PC. This cable accommodates both circuit and packet data applications. The cable also features a charging port. Any applicable phone charger may be used to charge the phone simultaneously.

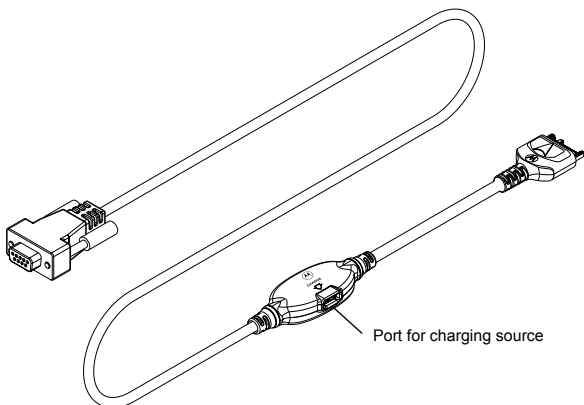

Using the Data Cable

- 1 While holding the phone with its keypad facing up, insert the accessory connector (with the Motorola logo facing you) into the bottom of the phone until you hear a click.
- 2 Insert the data plug directly into your PC or one of the many other data compatible iDEN accessories.

Dual Port Adapter Cable

The Dual Port Adapter Cable enables in-vehicle communications and charging of the i80s phone via the Hands-Free Car kit, while being simultaneously connected for data operations.

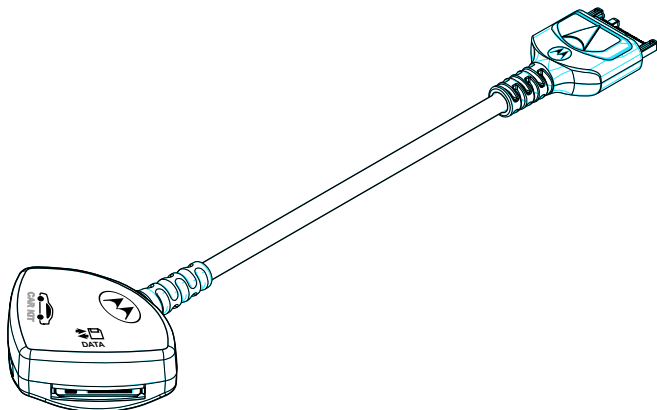

Using the Dual Port Adapter Cable

- | | |
|----------|--|
| 1 | Insert the flat end of the Dual Port Adapter Cable cord into the bottom connector of the i80s phone. Make sure the Motorola logo is facing upward. |
| 2 | Insert the round end of the RS232 Data Cable into the receptacle on the Dual Port Adapter Cable labeled "Data". |
| 3 | Insert the Hands-Free Car Kit into the receptacle on the Dual Port Adapter Cable labeled "Car Kit". |

PDA Converter Plugs

The PDA (Pocket Digital Assistant) plug is a convenient way to connect your *i80s* phone to many types of PDA devices, both PC and Windows CE compatible.

Below is the list of adapters which can be used with your *i80s* phone:

Item Number	Description
NTN6546	Palm III™/VII™ Cable Adapter
NKN6547	Palm V™ Cable Adapter
NTN8993	Generic Pocket Digital Assistant (PDA) -Male-Female Serial Adapter (Not Shown)

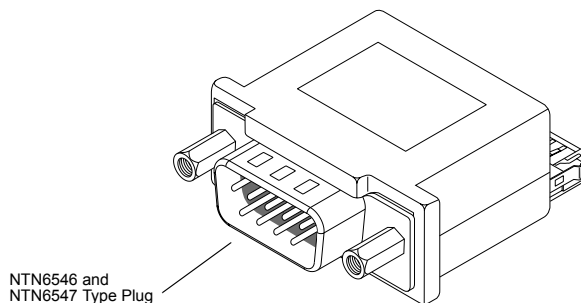

Using the PDA Converter Plug

- 1 While holding the phone with its keypad facing up, insert the accessory connector (with the Motorola logo facing you) into the bottom of the phone until you hear a click.
- 2 Connect the opposite end of the data cable to the PDA converter.

- 3** Connect other end of PDA converter to the mating connector of the PDA device.
- 4** If you are using the NTN8993 PDA adapter, connect the other end of the adapter to the PDA's supplied data synchronization cradle and place the PDA into the cradle.

NOTE: Please see the label on the bottom of your Dual-Pocket Desktop Charger for more information regarding battery charging status.

Universal Serial Bus (USB)

Your user will be able communicate with USB capable laptop and desktop computers.

USB capable *i80s* phone supports both RS232 communications and USB communications (with USB mother devices). The *i80s* phone will automatically detect whether an RS232 or USB cable has been connected to it and will utilize the appropriate protocol accordingly. No other action is required by the user in order to select between USB or RS232 serial communications.

iDEN PC applications will support USB drivers for the following operating systems only:

- Windows 98 Second Edition (SE)
- Windows 2000

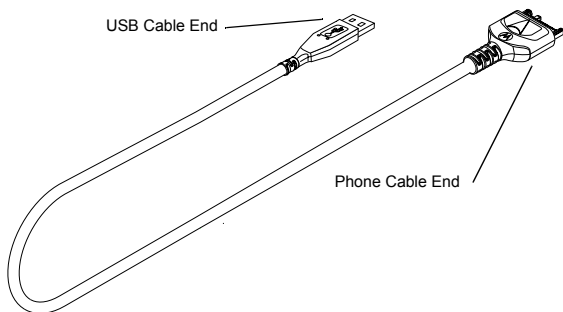

PC Applications Supported

- RSS
- Tethered Circuit Data
- iDEN CompanionPro
- SDK (Windows only, Palm SDK not supported)
- iDEN Update ~ after first upgrade
- iDEN Applet for Data Services

Other Important Information

This section includes the following topics:

Understanding Status Messages	Page 151
Safety and General Information	Page 153
Limited Warranty Information	Page 163
Patent and Trademark Information	Page 171

Understanding Status Messages

The following table lists and describes the status messages.

Status Messages	Message Description
Number Not in Service	The number that you entered is not valid.
User Not Available	The phone that you called is either busy, out-of-coverage, or turned off. Please try again later.
User Not Authorized	The person that you called has not purchased this service.
Please Try Later	This service is temporarily not available. Please try again later.
User Busy in Private	The phone that you called is busy in a Private call.
User Busy in Data	The phone that you called is busy in a Dial-Up call.
Service Restricted	This service was restricted by your service provider, or this service was not purchased.
Service Not Available	This feature is not available on the current network.

Status Messages	Message Description
System Busy Try Later	The system is experiencing heavy traffic. Please try again later.
Service Conflict	This service cannot be enabled because an incompatible service has already been turned on.
Please Try Again	An error occurred. Please try again.
Self Check Error	A fault was detected with your phone. If this error recurs, note the error code and contact Customer Care.
Self Check Fail	An operational fault was detected with your phone. Note the numeric code, turn your phone off, and contact Customer Care.
PIN Blocked Call Your Provider	The incorrect PIN was entered three consecutive times. You will be unable to place or receive calls on your i80s phone. Call your service provider to have them obtain the PIN Unblocking Key (PUK) code.
Insert SIM	Your SIM Card is not being detected. Please check to ensure that you have inserted the SIM Card.
Check SIM Card	Please check your SIM Card to make sure it has been inserted properly.
Wrong PIN	You have entered an incorrect PIN number.
Wrong Code	Your phone will not accept a SIM card that is not from your carrier.

Safety and General Information

IMPORTANT INFORMATION ON SAFE AND EFFICIENT OPERATION.

READ THIS INFORMATION BEFORE USING YOUR INTEGRATED MULTI-SERVICE PORTABLE RADIO.

RF Operational Characteristics

Your radio product contains a radio frequency transmitter to convey the information you wish to send as well as occasional automatic signals used to sustain connection to the wireless network, and a receiver which enables you to receive communication and connection information from the network.

PORTABLE RADIO PRODUCT OPERATION AND EME EXPOSURE

Your Motorola radio product is designed to comply with the following national and international standards and guidelines regarding exposure of human beings to radio frequency electromagnetic energy (EME):

- United States Federal Communications Commission, Code of Federal Regulations; 47 CFR part 2 sub-part J
- American National Standards Institute (ANSI) / Institute of Electrical and Electronics Engineers (IEEE). C95. 1-1992
- Institute of Electrical and Electronics Engineers (IEEE). C95. 1-1999 Edition
- National Council on Radiation Protection and Measurements (NCRP) of the United States, Report 86, 1986
- International Commission on Non-Ionizing Radiation Protection (ICNIRP) 1998
- Ministry of Health (Canada). Safety Code 6. Limits of Human Exposure to Radiofrequency Electromagnetic Fields in the Frequency Range from 3 kHz to 300 GHz, 1999.
- Australian Communications Authority Radiocommunications (Electromagnetic Radiation - Human Exposure) Standard 1999 (applicable to wireless phones only)

To assure optimal radio product performance and make sure human exposure to radio frequency electromagnetic energy is within the guidelines set forth in the above standards, always adhere to the following procedures:

Phone Operation

When placing or receiving a phone call, hold your radio product as you would a wireline telephone. **Speak directly into the microphone.**

Two-way radio operation

When using your radio product as a traditional two-way radio, **hold the radio product in a vertical position with the microphone one to two inches (2.5 to 5 cm) away from the lips.**



Body-worn operation

To maintain compliance with FCC RF exposure guidelines, if you wear a radio product on your body when transmitting, always place the radio product in a **Motorola approved clip, holder, holster, case or body harness for this product.** Use of non-Motorola-approved accessories may exceed FCC RF exposure guidelines. **If you do not use a Motorola approved body-worn accessory and are not using the radio product in the intended use positions along side of the head in the phone mode or in front of the face in the two-way radio mode, then ensure the antenna and the radio product is kept the following minimum distances from the body when transmitting:**

- **Phone or Two-way radio mode: one inch (2.5 cm)**
- **Data operation using any data feature with or without an accessory cable: one inch (2.5 cm)**

Antenna Care

Use only the supplied or an approved replacement antenna. Unauthorized antennas, modifications, or attachments could damage the radio product and may violate FCC regulations.

DO NOT hold the antenna when the radio product is “IN USE”. Holding the antenna affects call quality and may cause the radio product to operate at a higher power level than needed.

Approved Accessories

For a list of approved Motorola accessories call 1-800-453-0920, or visit our website at www.mot.com/iden, or look in the accessory section of this manual.

THIS MODEL PHONE MEETS THE GOVERNMENT'S REQUIREMENTS FOR EXPOSURE TO RADIO WAVES.

Your wireless phone is a radio transmitter and receiver. It is designed and manufactured not to exceed the emission limits for exposure to radiofrequency (RF) energy set by the Federal Communications Commission of the U.S. Government. These limits are part of comprehensive guidelines and establish permitted levels of RF energy for the general population. The guidelines are based on standards that were developed by independent scientific organizations through periodic and thorough evaluation of scientific studies. The standards include a substantial safety margin designed to assure the safety of all persons, regardless of age and health.

The exposure standard for wireless mobile phones employs a unit of measurement known as the Specific Absorption Rate, or SAR. The SAR limit set by the FCC is 1.6W/kg.* Tests for SAR are conducted using standard operating positions reviewed by the FCC with the phone transmitting at its highest certified power level in all tested frequency bands. Although the SAR is determined at the highest certified power level, the actual SAR level of the phone while operating can be well below the maximum value. This is because the phone is designed to operate at multiple power levels so as to use only the power required to reach the network. In general, the closer you are to a wireless base station antenna, the lower the power output.

Before a phone model is available for sale to the public, it must be tested and certified to the FCC that it does not exceed the limit established by the government-adopted requirement for safe exposure. The tests are performed in positions and locations (e.g., at the ear and worn on the body) as required by the FCC for each model. The highest SAR value for this model phone when tested for use at the ear is 1.37 W/kg and when tested on the body, as described in this user guide, is 0.60 W/kg during voice transmission using Phone Mode and 0.89 W/kg during packet data transmission. (Body-worn measurements differ among phone models, depending upon available accessories and FCC requirements.) While there may be differences between the SAR levels of various phones and at various positions, they all meet the government requirement for safe exposure.

The FCC has granted an Equipment Authorization for this model phone with all reported SAR levels evaluated as in compliance with the FCC RF exposure guidelines. SAR information on this model phone is on file with the FCC and can be found under the Display Grant section of <http://www.fcc.gov/oet/fccid> after searching on FCC ID AZ489FT5807.

Additional information on Specific Absorption Rates (SAR) can be found on the Cellular Telecommunications Industry Association (CTIA) web-site at <http://www.wow-com.com>.

* In the United States and Canada, the SAR limit for mobile phones used by the public is 1.6 watts/kg (W/kg) averaged over one gram of tissue. The standard incorporates a substantial margin of safety to give additional protection for the public and to account for any variations in measurements.

Electro Magnetic Interference/Compatibility

NOTE: Nearly every electronic device is susceptible to electromagnetic interference (EMI) if inadequately shielded, designed or otherwise configured for electromagnetic compatibility.

Facilities

To avoid electromagnetic interference and/or compatibility conflicts, turn off your radio product in any facility where posted notices instruct you to do so. Hospitals or health care facilities may be using equipment that is sensitive to external RF energy.

Aircraft

When instructed to do so, turn off your radio product when on board an aircraft. Any use of a radio product must be in accordance with applicable regulations per airline crew instructions.

Medical Devices

Pacemakers

The Health Industry Manufacturers Association recommends that a minimum separation of 6 inches (15 cm) be maintained between a handheld wireless radio product and a pacemaker. These recommendations are consistent with those of the U.S. Food and Drug Administration.

Persons with pacemakers should:

- ALWAYS keep the radio product more than 6 inches (15 cm) from their pacemaker when the radio product is turned ON.
- Not carry the radio product in a breast pocket.
- Use the ear opposite the pacemaker to minimize the potential for interference.
- Turn the radio product OFF immediately if you have any reason to suspect that interference is taking place.

Hearing Aids

Some digital wireless radio products may interfere with some hearing aids. In the event of such interference, you may want to consult your hearing aid manufacturer to discuss alternatives.

Other Medical Devices

If you use any other personal medical device, consult the manufacturer of your device to determine if it is adequately shielded from RF energy. Your physician may be able to assist you in obtaining this information.

www.motorola.com/iden

Use While Driving

Check the laws and regulations on the use of radio products in the area where you drive. Always obey them.

When using the radio product while driving, please:

- Give full attention to driving and to the road.
- Use hands-free operation, if available.
- Pull off the road and park before making or answering a call if driving conditions so require.

**WARNING**

Operational Warnings

For Vehicles with an Air Bag

Do not place a portable radio product in the area over the air bag or in the air bag deployment area. Air bags inflate with great force. If a portable radio is placed in the air bag deployment area and the air bag inflates, the radio product may be propelled with great force and cause serious injury to occupants of the vehicle.

Potentially Explosive Atmospheres

Turn off your radio product prior to entering any area with a potentially explosive atmosphere, unless it is a radio product type especially qualified for use in such areas as “Intrinsically Safe” (for example, Factory Mutual, CSA, or UL approved). Do not remove, install, or charge batteries in such areas. Sparks in a potentially explosive atmosphere can cause an explosion or fire resulting in bodily injury or even death.

NOTE: The areas with potentially explosive atmospheres referred to above include fueling areas such as below decks on boats, fuel or chemical transfer or storage facilities, areas where the air contains chemicals or particles, such as grain, dust or metal powders, and any other area where you would normally be advised to turn off your vehicle engine. Areas with potentially explosive atmospheres are often but not always posted.

Blasting Caps and Areas

To avoid possible interference with blasting operations, turn off your radio product when you are near electrical blasting caps, in a blasting area, or in areas posted: “Turn off two-way radio”. Obey all signs and instructions.



Caution

Operational Cautions

Antennas

Do not use any portable radio product that has a damaged antenna. If a damaged antenna comes into contact with your skin, a minor burn can result.

Batteries

All batteries can cause property damage and/or bodily injury, such as burns if a conductive material such as jewelry, keys, or beaded chains touches exposed terminals. The conductive material may complete an electrical circuit (short circuit) and become quite hot. Exercise care in handling any charged battery, particularly when placing it inside a pocket, purse, or other container with metal objects.

Cleaning and Drying Considerations

Using a leather carry case may help protect the surfaces and help prevent liquids (e.g., rain) from entering into the interior of the radio product. This product is not water proof, and exposing the unit to liquids may result in permanent damage to the unit.

If your radio product interior gets wet, then do not try to accelerate drying with the use of an oven or a dryer as this will damage the radio product and void the warranty. Instead, do the following:

1. Immediately power off the radio product.
2. Remove Battery and SIM card (if so equipped) from radio product.
3. Shake excess liquid from radio product.
4. Place the radio product and battery in an area that is at room temperature and has good air flow.

5. Let the radio product, battery dry, and SIM card for 72 hours before reconnecting the battery and/or powering on the radio product.

If the radio product does not work after following the steps listed above, contact your dealer for servicing information.

Clean the external surfaces of the radio product with a damp cloth, using a mild solution of dishwashing detergent and water. Some household cleaners may contain chemicals that could seriously damage the radio product. Avoid the use of any petroleum-based solvent cleaners. Also, avoid applying liquids directly on the radio product.

Accessory Safety Information

IMPORTANT:

SAVE THESE ACCESSORY SAFETY INSTRUCTIONS

- Before using any battery or battery charger, read all the instructions for and cautionary markings on (1) the battery, (2) the battery charger, which may include a separate wall-mounted power supply or transformer, and (3) the radio product using the battery.
- Do not expose any battery charger to water, rain, or snow as they are designed for indoor or in-vehicle use only.

 <p>WARNING</p>	<p>To reduce the risk of injury, charge only the rechargeable batteries listed in the Accessories section of this manual. Other types of batteries may burst, causing personal injury and damage.</p>
---	--

- To reduce the risk of damage to the cord or plug, pull by the plug rather than the cord when you disconnect the battery charger from the power source outlet.
- Do not operate any battery charger with a damaged cord or plug — replace them immediately.
- Battery chargers may become warm during operation, but not hot. If it becomes hot to the touch, unplug it from the power outlet immediately and discontinue its use.
- Use of a non-recommended attachment to a battery charger may result in a risk of fire, electric shock, or injury to persons.
- Make sure the battery charger power cord is located so that it will not be stepped on, tripped over, or subjected to damage or stress.
- An extension cord should not be used with any battery charger unless absolutely necessary. Use of an improper extension cord could result in a risk of fire and electric shock. If an extension cord must be used, make sure that:
 - The pins on the plug of the extension cord are the same number, size, and shape as those on the plug of the charger.
 - The extension cord is properly wired and in good electrical condition.
 - The cord size is 18AWG for lengths up to 100 feet and 16AWG for lengths up to 150 feet.

- Do not operate any battery charger if it has received a sharp blow, has been dropped, or has been damaged in any way; take it to a qualified service technician.
- Do not disassemble a battery charger; take it to a qualified service technician when service or repair is required. Incorrect reassembly may result in a risk of electric shock or fire.
- Maximum ambient temperature around the power supply or transformer of any battery charger should not exceed 40°C (104°F).
- The output power from the power supply or transformer must not exceed the rating given on the Desktop Dual-Pocket Charger.
- The disconnection from the line voltage is made by unplugging the power supply from the AC receptacle.
- To reduce risk of electric shock, unplug any battery charger from the outlet before attempting any maintenance or cleaning.

For optimum charging performance, turn off the radio product while charging it in any battery charger.

Limited Warranty Motorola Communication Products

NOTE :

This Warranty applies within the fifty (50) united states and the District of Columbia

I. WHAT THIS WARRANTY COVERS AND FOR HOW LONG:

MOTOROLA, INC. (“MOTOROLA”) warrants the MOTOROLA manufactured iDEN Communication Products listed below (“Product”) against defects in material and workmanship under normal use and service for a period of time from the date of purchase as scheduled below:

iDEN Subscriber Digital Mobile and Portable Units	One (1) Year
Product Accessories	One (1) Year
Batteries	One (1) Year

Rechargeable Batteries will be replaced during the applicable warranty period if:

- a. the battery capacity falls below 80% of rated capacity, or
- b. the battery develops leakage.

MOTOROLA, at its option, will at no charge either repair the Product (with new or reconditioned parts), replace it (with a new or reconditioned Product), or refund the purchase price of the Product during the warranty period provided it is returned in accordance with the terms of this warranty. Replaced parts or boards are warranted for the balance of the original applicable warranty period. All replaced parts of Product shall become the property of MOTOROLA.

This express limited warranty is extended by MOTOROLA to the original end user purchaser only and is not assignable or transferable to any other party. This is the complete warranty for the Product manufactured by MOTOROLA. MOTOROLA assumes no obligations or liability for additions or modifications

to this warranty unless made in writing and signed by an officer of MOTOROLA. Unless made in a separate agreement between MOTOROLA and the original end user purchaser, MOTOROLA does not warrant the installation, maintenance or service of the Product.

MOTOROLA cannot be responsible in any way for any ancillary equipment not furnished by MOTOROLA which is attached to or used in connection with the Product, or for operation of the Product with any ancillary equipment, and all such equipment if expressly excluded from this warranty. Because each system which may use the Product is unique, MOTOROLA disclaims liability for range, coverage, or operation of the system as a whole under this warranty.

II. GENERAL PROVISIONS:

This warranty sets forth the full extent of MOTOROLA'S responsibilities regarding the Product, Repair, replacement or refund of the purchase price, at MOTOROLA'S options, is the exclusive remedy. THIS WARRANTY IS GIVEN IN LIEU OF ALL OTHER EXPRESS WARRANTIES. IMPLIED WARRANTIES, INCLUDING WITHOUT LIMITATION, IMPLIED WARRANTIES OF MERCHANTABILITY AND FITNESS FOR A PARTICULAR PURPOSE, ARE LIMITED TO THE DURATION OF THIS LIMITED WARRANTY. IN NO EVENT SHALL MOTOROLA BE LIABLE FOR DAMAGES IN EXCESS OF THE PURCHASE PRICE OF THE PRODUCT, FOR ANY LOSS OF USE, LOSS OF TIME, INCONVENIENCE, COMMERCIAL LOSS, LOST PROFITS OR SAVINGS OR OTHER INCIDENTAL, SPECIAL OR CONSEQUENTIAL DAMAGES ARISING OUT OF THE USE OR INABILITY TO USE SUCH PRODUCT, TO THE FULL EXTENT SUCH MAY BE DISCLAIMED BY LAW.

III. STATE LAW RIGHTS:

SOME STATES DO NOT ALLOW THE EXCLUSION OR LIMITATION OF INCIDENTAL OR CONSEQUENTIAL DAMAGES, OR LIMITATION ON HOW LONG AN IMPLIED WARRANTY LASTS, SO THE ABOVE LIMITATIONS OR EXCLUSIONS MAY NOT APPLY.

This warranty gives specific legal rights, and there may be other rights which may vary from state to state.

IV. HOW TO GET WARRANTY SERVICE:

You must provide proof of purchase (bearing the date of purchase and Product item serial number) in order to receive warranty service and, also, deliver or send the Product item, transportation and insurance prepaid, to an authorized warranty service location. Warranty service will be provided by MOTOROLA through one of its authorized warranty service locations. If you first contact the company which sold you the Product (e.g., dealer or communication service provider), it can facilitate your obtaining warranty service. You can also call MOTOROLA at 1-800-453-0920 for warranty service location information.

V. WHAT THIS WARRANTY DOES NOT COVER:

- a. Defects or damage resulting from use of the Product in other than its normal and customary manner.
- b. Defects or damage from misuse, accident, water, or neglect.
- c. Defects or damage from improper testing, operation, maintenance, installation, alteration, modification, or adjustment.
- d. Breakage or damage to antennas unless caused directly by defects in material workmanship.
- e. A Product subjected to unauthorized Product modifications, disassemblies or repairs (including, without limitation, the audition to the Product of non-MOTOROLA supplied equipment) which adversely affect performance of the Product or interfere with MOTOROLA'S normal warranty inspection and testing of the Product to verify any warranty claim.
- f. Product which has had the serial number removed or made illegible.
- g. Rechargeable batteries if:
 1. Any of the seals on the battery enclosure of cells are broken or show evidence of tampering.
 2. The damage or defect is caused by charging or using the battery in equipment or service other than the Product for which it is specified.
- h. Freight costs to the repair depot.
- i. A Product which, due to illegal or unauthorized alteration of the software/firmware in the Product, does not function in accordance with MOTOROLA'S published specifications or the FCC type acceptance labeling in effect for the Product at the time the Product was initially distributed from MOTOROLA.
- j. Scratches or other cosmetic damage to Product surfaces that does not effect the operation of the Product.
- k. Normal and customary wear and tear.

VI. PATENT AND SOFTWARE PROVISIONS:

MOTOROLA will defend, at its own expense, any suit brought against the end user purchaser to the extent that it is based on a claim that the Product or parts infringe a United States patent, and Motorola will pay those costs and damages finally awarded against the end user purchaser in any such suit which are attributable to any such claim, but such defense and payments are conditioned on the following:

- a. That MOTOROLA will be notified promptly in writing by such purchaser of any notice of such claim;
- b. That MOTOROLA will have sole control of the defense of such suit and all negotiations for its settlement or compromise; and
- c. Should the Product or parts become, or in MOTOROLA'S opinion be likely to become, the subject of a claim of infringement of a patent, that such purchaser will permit MOTOROLA, at its option and expense, either to procure for such purchaser the right to continue using the Product or parts or to replace or modify the same so that it becomes non-infringing or to grant such purchaser a credit for the Product or parts as depreciated and accept its return. The depreciation will be an equal amount per year over the lifetime of the Product or parts as established by MOTOROLA.

MOTOROLA will have no liability with respect to any claim of patent infringement which is based upon the combination of the Product or parts furnished hereunder with software, apparatus or devices not furnished by MOTOROLA, nor will MOTOROLA have any liability for the use of ancillary equipment or software not furnished by MOTOROLA which is attached to or used in connection with the Product or any parts thereof.

Laws in the United States and other countries preserve for MOTOROLA certain exclusive rights for copyrighted MOTOROLA software, such as the exclusive rights to reproduce in copies and distribute copies of such MOTOROLA software. MOTOROLA software may be used in only the Product in which the software was originally embodied and such software in such Product may not be replaced, copied, distributed, modified in any way, or used to produce any derivative thereof. No other use including, without limitation, alteration, modification, reproduction, distribution, or reverse engineering of such MOTOROLA software or exercise of rights in such MOTOROLA software is permitted. No license is granted by implication, estoppel or otherwise under MOTOROLA patent rights or copyrights.

Limited Warranty Motorola Communication Products (International)

NOTE :	This Warranty applies in Singapore and the Philippines.
---------------	---

I. WHAT THIS WARRANTY COVERS AND FOR HOW LONG:

MOTOROLA warrants the MOTOROLA manufactured iDEN Communication Products listed below (“Product”) against defects in material and workmanship under normal use and service for a period of time from the date of purchase as scheduled below:

iDEN Subscriber Digital Mobile and Portable Units	One (1) Year
Product Accessories (manufactured by or under license from MOTOROLA)	One (1) Year
Batteries	One (1) Year

Rechargeable Batteries will be replaced during the applicable warranty period if:

- a. the battery capacity falls below 80% of rated capacity, or
- b. the battery develops leakage.

MOTOROLA, at its option, will at no charge either repair the Product (with new or reconditioned parts), replace it (with a new or reconditioned Product), or refund the purchase price of the Product during the warranty period provided it is returned in accordance with the terms of this warranty. Replaced parts or boards are warranted for the balance of the original applicable warranty period. All replaced parts of Product shall become the property of MOTOROLA.

This express limited warranty is extended by MOTOROLA to the original end user purchaser only and is not assignable or transferable to any other party. This is the complete warranty for the Product manufactured by MOTOROLA. MOTOROLA assumes no obligations or liability for additions or modifications

to this warranty unless made in writing and signed by an officer of MOTOROLA. Unless made in a separate agreement between MOTOROLA and the original end user purchaser, MOTOROLA does not warrant the installation, maintenance or service of the Product.

MOTOROLA cannot be responsible in any way for any ancillary equipment not furnished by MOTOROLA which is attached to or used in connection with the Product, or for operation of the Product with any ancillary equipment, and all such equipment if expressly excluded from this warranty. Because each system which may use the Product is unique, MOTOROLA disclaims liability for range, coverage, or operation of the system as a whole under this warranty.

II. GENERAL PROVISIONS:

This warranty sets forth the full extent of MOTOROLA'S responsibilities regarding the Product, Repair, replacement or refund of the purchase price, at MOTOROLA'S options, is the exclusive remedy. THIS WARRANTY IS GIVEN IN LIEU OF ALL OTHER EXPRESS WARRANTIES. IMPLIED WARRANTIES, INCLUDING WITHOUT LIMITATION, IMPLIED WARRANTIES OF MERCHANTABILITY AND FITNESS FOR A PARTICULAR PURPOSE, ARE LIMITED TO THE DURATION OF THIS LIMITED WARRANTY TO THE FULL EXTENT SUCH MAY BE DISCLAIMED BY LAW. IN NO EVENT SHALL MOTOROLA BE LIABLE FOR DAMAGES IN EXCESS OF THE PURCHASE PRICE OF THE PRODUCT, FOR ANY LOSS OF USE, LOSS OF TIME, INCONVENIENCE, COMMERCIAL LOSS, LOST PROFITS OR SAVINGS OR OTHER INCIDENTAL, SPECIAL OR CONSEQUENTIAL DAMAGES ARISING OUT OF THE USE OR INABILITY TO USE SUCH PRODUCT, TO THE FULL EXTENT SUCH MAY BE DISCLAIMED BY LAW.

III. HOW TO GET WARRANTY SERVICE:

You must provide proof of purchase (bearing the date of purchase and Product item serial number) in order to receive warranty service and, also, deliver or send the Product item, transportation and insurance prepaid, to an authorized warranty service location. Warranty service will be provided by MOTOROLA through one of its authorized warranty service locations. If you first contact the company which sold you the Product (e.g., dealer or communication service provider), it can facilitate your obtaining warranty service.

IV. WHAT THIS WARRANTY DOES NOT COVER:

- a. Defects or damage resulting from use of the Product in other than its normal and customary manner.

Limited Warranty Motorola Communication Products (International)

- b. Defects or damage from misuse, accident, water, or neglect.
- c. Defects or damage from improper testing, operation, maintenance, installation, alteration, modification, or adjustment.
- d. Breakage or damage to antennas unless caused directly by defects in material workmanship.
- e. A Product subjected to unauthorized Product modifications, disassemblies or repairs (including, without limitation, the audition to the Product of non-MOTOROLA supplied equipment).
- f. Product which has had the serial number removed or made illegible.
- g. Rechargeable batteries if:
 - 1. Any of the seals on the battery enclosure of cells are broken or show evidence of tampering.
 - 2. The damage or defect is caused by charging or using the battery in equipment or service other than the Product for which it is specified.
- h. Freight costs to the repair depot.
- i. A Product which, due to illegal or unauthorized alteration of the software/firmware in the Product, does not function in accordance with MOTOROLA'S published specifications or the local type acceptance labeling in effect for the Product at the time the Product was initially distributed from MOTOROLA.
- j. Scratches or other cosmetic damage to Product surfaces that does not effect the operation of the Product.
- k. Normal and customary wear and tear.
- l. Exclusion for defects or damage arising from use of the products in connection with non-MOTOROLA equipment.

V. PATENT AND SOFTWARE PROVISIONS:

MOTOROLA will defend, at its own expense, any suit brought against the end user purchaser to the extent that it is based on a claim that the Product or parts infringe a patent, and Motorola will pay those costs and damages finally awarded against the end user purchaser in any such suit which are attributable to any such claim, but such defense and payments are conditioned on the following:

- a. That MOTOROLA will be notified promptly in writing by such purchaser of any notice of such claim;
- b. That MOTOROLA will have sole control of the defense of such suit and all negotiations for its settlement or compromise; and
- c. Should the Product or parts become, or in MOTOROLA'S opinion be likely to become, the subject of a claim of infringement of a patent,

that such purchaser will permit MOTOROLA, at its option and expense, either to procure for such purchaser the right to continue using the Product or parts or to replace or modify the same so that it becomes non-infringing or to grant such purchaser a credit for the Product or parts as depreciated and accept its return. The depreciation will be an equal amount per year over the lifetime of the Product or parts as established by MOTOROLA.

MOTOROLA will have no liability with respect to any claim of patent infringement which is based upon the combination of the Product or parts furnished hereunder with software, apparatus or devices not furnished by MOTOROLA, nor will MOTOROLA have any liability for the use of ancillary equipment or software not furnished by MOTOROLA which is attached to or sued in connection with the Product or any parts thereof. In no event shall MOTOROLA be liable for any incidental, special or consequential damages arising from any claim of patent infringement or alleged infringement.

Laws in the United States and other countries preserve for MOTOROLA certain exclusive rights for copyrighted MOTOROLA software, such as the exclusive rights to reproduce in copies and distribute copies of such MOTOROLA software. MOTOROLA software may be used in only the Product in which the software was originally embodied and such software in such Product may not be replaced, copied, distributed, modified in any way, or used to produce any derivative thereof. No other use including, without limitation, alteration, modification, reproduction, distribution, or reverse engineering of such MOTOROLA software or exercise or rights in such MOTOROLA software is permitted. No license is granted by implication, estoppel or otherwise under MOTOROLA patent rights or copyrights.

Patent and Trademark Information

MOTOROLA, the Stylized M Logo and all other trademarks indicated as such herein are trademarks of Motorola, Inc. ® Reg. U.S. Pat. & Tm. Off. © 2001 Motorola, Inc. All rights reserved. Manufactured under one or more of the U.S. patents listed in the User's Guide.

Microsoft and, Microsoft WEB Explorer, are registered trademarks of Microsoft Corporation.

Netscape Navigator is a registered trademark of Netscape Communications Corporation.

T9 is a trademark owned by Tegic Communications.

T9® Text Input Patent and Trademark Information

This product is covered by U.S. Pat. 5,818,437, U.S. Pat. 5,953,541, U.S. Pat. 6,011,554 and other patents pending.

Java and all other Java-based marks are trademarks or registered trademarks of Sun Microsystems, Inc. in the U.S. and other countries.

Direct Protect is a trademark of Signal Insurance Company.

All other product or service names mentioned in this manual are the property of their respective trademark owners.

Index

A

- Accessories **139**
 - batteries **142**
 - Data cable **79, 145, 146**
 - Dual Port Adapter Cable **146**
 - Swivel Carry Clip **139**
 - Travel Charger **143**
- Accessory safety information **161**
- Adapter cable **146**
- Alpha mode, text entry **27**
- Auto Redial **125**

B

- Backlight timer **125**
- Battery **142**
 - attaching **11**
 - charge strength **13**
 - charging **12**
 - detaching **11**
 - operating **142**
- Battery Charging **13**
- Baud rate **127**

C

- Call Alert Queue **85**
- Call alerts **83**
 - from Phonebook **84**
 - receiving **85**
- Call Filtering **133**
- Call Forwarding **68**
 - turning off **70**
 - turning on **69**
- Call Hold **66**
- Call Timers **63, 64**
- Call Waiting **64, 120**

- accepting calls **64**
- declining calls **65**
- ending active calls **65**
- switching between calls **65**
- turning off **65**

- Charge strength **13**
- Circuit data **79**
- Circuit data number **25**
- CompanionPro **40**
- Connection status **24**
- Customizing Java applications **106**
- Customizing phone **115**

D

- Data cable **79, 145, 146**
- Datebook **91**
 - set up **100**
 - viewing **92**
 - viewing a day **93**
 - viewing a week **93**
 - viewing event details **94**
 - viewing today **94**
- Datebook events **94**
 - adding **95**
 - deleting **99**
 - editing **99**
- Datebook icons **92**
- Delete
 - Customizing the i80s Phone **137**
 - Shortcut Menu **137**
- Dialing menu **48**
- Digital cellular **53**
- Direct dial **54**
- Display options **34**
 - changing **122**

Driving safety **6**

E

email **79**

 sending and receiving **78**

Entering text, see Text entry

F

Faxes

 sending and receiving **79**

G

Getting started **9**

Group calls **87**

I

Icons

 context sensitive **31**

 Datebook **92**

 main menu **36**

 Phonebook **40**

 status **31**

In Call Setup **119**

Initial Setup **123**

Initial SIM PIN number **15**

International calls **51, 57**

IP Address **25**

J

Java applications **105**

 deinstalling **108**

 downloading **106**

 installing **107**

 memory **107, 108**

K

Keypad Lock **121**

L

Language **27, 126**

M

Main menu **37**

 icons **36**

 options **36**

 reordering **122**

Making call alerts **83**

Making phone calls **53**

Making Private calls **81**

Master Reset **121**

Memo **103**

 adding **103**

 deleting **104**

 editing **104**

 viewing **103**

Memory

 Java **107, 108**

 Voice Notes **113**

Menu icon **34**

Menus **34, 35, 48**

 main menu **37**

 Styles Actions menu **133**

 Styles menu **130**

Message Center **73**

Messages **73**

 Net Mail **78**

 text and numeric **76**

 voice mail **74**

Messages, Net Mail

 receiving **78**

Messages, text and numeric

 receiving **77**

 viewing **77**

Missed call **59**

Modem, phone as **79**

Motorola **6**

Mute **62**

My Information **25**

N

- Net Mail **78**
- Notifications **120**
 - setting **118**
- Numeric mode, text entry **30**

P

- Packet data **79**
- Password
 - security code **121**
 - SIM PIN **121**
 - unlock code **121**
- Patent information **171**
- Pause digit entry **49**
- Personalize **121**
- Phone
 - modem **79**
 - off **14**
 - on **14**
 - status **24**
- Phone calls **53**
 - ending **59**
 - from Phonebook **54**
 - from Recent Calls list **55**
 - international calls **57**
 - receiving **59**
 - speed dial **56**
 - Turbo Dial **56**
 - voice names **57**
- Phone Lock **120**
- Phone Setup **119**
- Phonebook **39**
 - capacity **44**
 - CompanionPro **40**
 - making call alerts **84**
 - making calls **54**
 - Private calls **81**

- storing Recent Calls **61**
 - with non-i85s phones **40**
 - with other i85s phones **39**

- Phonebook entries **42**
 - adding **44**
 - deleting **49**
 - editing **49**
 - sorting **43**
 - viewing **42**
- Plus dialing **51**
- Power button **14**
- Powering phone on or off **14**
- Private calls **81**
 - from Phonebook **81**
 - from Recent Calls list **82**
 - making **81**
 - receiving **83**
 - voice names **82**
- PUK code **18**

R

- Radio frequency **153**
- Ready screen **31**
- Recent Calls **48, 55, 59**
 - deleting **61**
 - details **60**
 - Private calls **82**
 - storing to Phonebook **61**
 - viewing **59**
- Ring styles **118**
- Ring/Vibe **116**

S

- Safety **153**
 - accessory **161**
 - electromagnetic interference **156**
 - medical devices **156**

radio frequency **153**

Scrolling **126**

Security **15, 120**

Settings

- In Call Setup **119**
- Initial Setup **123**
- Personalize **121**
- Phone Setup **119**
- Ring/Vibe **116**
- Security **120**
- VoiceVolume **128**

Shortcut Menu **137**

Shortcuts **135**

- creating **135**
- using **136**

SIM card **15, 39**

- blocked **16**
- inserting and removing **20**
- unblocking **17, 18**
- with non-i85s phones **40**
- with other i85s phones **39**

SIM PIN **15, 121**

- changing **16**
- default **15**
- disabling **18**
- enabling **18**
- entering **15**

Speed Dial numbers **40, 46, 56**

Status light **24, 126**

Status messages **151**

Status of connection **24**

Styles

- activating **132**
- creating **130**
- turning off **132**

Swivel Carry Clip **139**

Symbols mode, text entry **30**

T

T9 Text Input **26**

- also see Text entry

Talkgroups **87**

- naming **87**

Text and numeric messages **76**

Text display

- area **33**

Text entry

- Alpha mode **27**
- Numeric mode **30**
- Symbols mode **30**
- Word mode **28**

Three-Way Calling **67**

Time and date format **124**

Trademark information **171**

Travel Charger **143**

TTY devices

- making calls **58**
- setting baud rate **128**
- setting mode **127**

Turbo Dial **56**

Turning phone on or off **14**

Two-way radio, see Private calls

Typing text, see Text entry

U

Unblocking SIM PIN **18**

V

Viewing Datebook **92**

Voice Activated dialing **57, 82**

- also see Voice names
- also see voice names

Voice Mail **74**

- logging in **75**
- receiving messages **74**
- transferring calls to **74**

-
- Voice names **41**
 - creating **47**
 - making calls **57, 82**
 - Phonebook **47**
 - shortcuts **137**
 - Voice Notes **62, 109**
 - adding **111**
 - deleting **112**
 - labeling **111**
 - locking **112**
 - memory **113**
 - playing **110**
 - recording **110**

W

- Warranty **167**
- Word mode, text entry **28**

