

Thermo Pride

CONDENSING GAS FURNACE HIGHBOY AND COUNTERFLOW USERS INFORMATION MANUAL

MODELS

FOR USE WITH NATURAL GAS

CHB-50N, CHB-75N, CHB-100N, CHB-125N
CDB-50N, CDB-75N, CDB-100N, CDB-125N

FOR USE WITH L.P. GAS (PROPANE)

CHB-50P, CHB-75P, CHB-100P, CHB-125P
CDB-50P, CDB-75P, CDB-100P, CDB-125P

⚠WARNING: IF YOU DO NOT FOLLOW THE SAFETY PRECAUTIONS BELOW AND IN THIS MANUAL, A FIRE OR EXPLOSION MAY RESULT CAUSING PROPERTY DAMAGE, PERSONAL INJURY, OR LOSS OF LIFE.

DO NOT STORE OR USE GASOLINE OR OTHER FLAMMABLE VAPORS AND LIQUIDS IN THE VICINITY OF THIS OR ANY OTHER APPLIANCE.

WHAT TO DO IF YOU SMELL GAS:

- DO NOT TRY TO LIGHT ANY APPLIANCE.
- DO NOT TOUCH ANY ELECTRICAL SWITCH; DO NOT USE ANY PHONE IN YOUR BUILDING.
- LEAVE THE BUILDING IMMEDIATELY.
- IMMEDIATELY CALL YOUR GAS SUPPLIER FROM A NEIGHBOR'S PHONE. FOLLOW THE GAS SUPPLIER'S INSTRUCTIONS.
- IF YOU CANNOT REACH YOUR GAS SUPPLIER; CALL THE FIRE DEPARTMENT.

INSTALLATION AND SERVICE MUST BE PERFORMED BY A QUALIFIED INSTALLER, SERVICE AGENCY OR THE GAS SUPPLIER. (REFERRED TO IN THESE INSTRUCTIONS AS A QUALIFIED HEATING CONTRACTOR).

PLEASE READ THESE INSTRUCTIONS PRIOR TO INITIAL FIRING, OPERATING THE FURNACE, AND BEFORE PERFORMING ANY MAINTENANCE. THESE INSTRUCTIONS MUST BE LEFT WITH THE HOMEOWNER AND SHOULD BE RETAINED FOR FUTURE REFERENCE BY THE HOMEOWNER/USER.

MG-986
ECN4199-MI 05/00

THERMO PRODUCTS, LLC.
BOX 217
NORTH JUDSON, IN 46366
PHONE: (219) 896-2133

MADE IN USA



INDEX

<u>SECTION</u>	<u>BEGINNING PAGE</u>
I. SAFETY INFORMATION	1
II. GENERAL INSTRUCTIONS	4
III. FURNACE OPERATION	7
A. WARNINGS BEFORE OPERATING	7
B. OPERATING INSTRUCTIONS	8
C. SHUTDOWN PROCEDURE	8
IV. HOMEOWNER/USER MAINTENANCE INSTRUCTIONS (ROUTINE MAINTENANCE)	8
A. ANNUAL INSPECTION	9
B. FILTER MAINTENANCE PROCEDURE	9
C. VISUAL INSPECTION PROCEDURE	11

All installations and services must be performed by qualified service personnel.

I. SAFETY INFORMATION

This and the following page contain reproductions of the various warning and instruction labels placed on the Thermo Pride Condensing Gas Furnaces. Please read and comply with the contents of these labels.

MODEL NO.

SERIAL NO.



**DIRECT VENT FORCED AIR FURNACE
FOR INDOOR INSTALLATION IN BUILDING
CONSTRUCTED ON SITE.**

ANSI Z21.47a-CAN/CGA-2.3a-1995
CENTRAL FURNACES



CATEGORY IV TYPE FSP
115 V 1 PH 60 CY MAX. TOTAL INPUT AMPS

INPUT BTU/HR	GAS	
NORMAL MANIFOLD PRESSURE	INCHES W.C.	
MIN. GAS SUPPLY PRESSURE FOR INPUT ADJUSTMENT	IN. W.C.	
MAX. GAS SUPPLY PRESSURE	INCHES. W.C.	
AIR TEMPERATURE RISE 55°F TO 85°F		
MAX. EXTERNAL STATIC PRESSURE	INCHES W.C.	
MAX. OUTLET AIR TEMPERATURE	190°F	

CERTIFIED FOR CLOSET INSTALLATION AT MINIMUM CLEARANCES
TO COMBUSTIBLE CONSTRUCTION AS SHOWN.

	TOP	FRONT	BACK	LS/RS	FLUE PIPE
(INCHES)	1	6	0	0	0

FOR INSTALLATION ON COMBUSTIBLE FLOORING.

THIS FURNACE REQUIRES A SPECIAL VENTING SYSTEM. REFER TO
INSTALLATION INSTRUCTIONS NO. MG-985 FOR PARTS LIST AND
METHOD OF INSTALLATION.
MAX. VENT LENGTH 35 FEET. MIN. VENT LENGTH 8 FEET.
MIN. WALL THICKNESS THROUGH WHICH THE VENT / AIR INTAKE
PIPES MAY PASS IS 2 INCHES AND THE MAX. IS 18 INCHES.
FILTER MUST BE INSTALLED EXTERNAL TO THE FURNACE CASING.
THIS FURNACE MUST BE INSTALLED IN ACCORDANCE WITH
THERMO PRODUCTS INSTRUCTIONS AND LOCAL CODES. IN
ABSENCE OF LOCAL CODES, FOLLOW THE NATIONAL FUEL
GAS CODE - ANSI Z223.1

Thermo Products, Inc.
P.O. BOX 217 - NORTH JUDSON, IN 46366

MODEL NO.

SERIAL NO.



**DIRECT VENT FORCED AIR FURNACE
FOR INDOOR INSTALLATION IN BUILDING
CONSTRUCTED ON SITE.**

ANSI Z21.47a-CAN/CGA-2.3a-1995
CENTRAL FURNACES



CATEGORY IV TYPE FSP
115 V 1 PH 60 CY MAX. TOTAL INPUT AMPS

INPUT BTU/HR	GAS	
NORMAL MANIFOLD PRESSURE	INCHES W.C.	
MIN. GAS SUPPLY PRESSURE FOR INPUT ADJUSTMENT	IN. W.C.	
MAX. GAS SUPPLY PRESSURE	INCHES. W.C.	
AIR TEMPERATURE RISE 55°F TO 85°F		
MAX. EXTERNAL STATIC PRESSURE	INCHES W.C.	
MAX. OUTLET AIR TEMPERATURE	190°F	

CERTIFIED FOR CLOSET INSTALLATION AT MINIMUM CLEARANCES
TO COMBUSTIBLE CONSTRUCTION AS SHOWN.

	TOP	FRONT	BACK	LS/RS	FLUE PIPE
(INCHES)	1	6	0	0	0

FOR INSTALLATION ON COMBUSTIBLE FLOORING.

THIS FURNACE REQUIRES A SPECIAL VENTING SYSTEM. REFER TO
INSTALLATION INSTRUCTIONS NO. MG-985 FOR PARTS LIST AND
METHOD OF INSTALLATION.
MAX. VENT LENGTH 35 FEET. MIN. VENT LENGTH 8 FEET.
MIN. WALL THICKNESS THROUGH WHICH THE VENT / AIR INTAKE
PIPES MAY PASS IS 2 INCHES AND THE MAX. IS 18 INCHES.
FILTER MUST BE INSTALLED EXTERNAL TO THE FURNACE CASING.
THIS FURNACE MUST BE INSTALLED IN ACCORDANCE WITH
THERMO PRODUCTS INSTRUCTIONS AND LOCAL CODES. IN
ABSENCE OF LOCAL CODES, FOLLOW THE NATIONAL FUEL
GAS CODE - ANSI Z223.1

Thermo Products, Inc.
P.O. BOX 217 - NORTH JUDSON, IN 46366

⚠ WARNING

Hazardous flue gas.
Can cause personal injury
or loss of life.

Inspect rubber hose
connecting inducer
outlet to PVC tee and
all vent system joints for
leak free connections
before furnace operation.

390411

WARNING

THIS COMPARTMENT MUST BE
CLOSED EXCEPT WHEN SERVICING

THIS FURNACE MUST BE INSTALLED SO THERE ARE
PROVISIONS FOR VENTILATING AIR.

390410

**REMOVE THIS PANEL FIRST IN ORDER
TO REMOVE BLOWER DOOR.**

INSTALLATION AND USERS MANUALS
ARE LOCATED BEHIND BLOWER DOOR.

390289

**OUTSIDE POWER SOURCE
CONNECT 115v 60Hz TO
L1 HOT AND L2 COMMON.**

390229

All installations and services must be performed by qualified service personnel.



This and the previous page contain reproductions of the various warning and instruction labels placed on the Thermo Pride Condensing Gas Furnaces. Please read and comply with the contents of these labels.

FOR YOUR SAFETY READ BEFORE OPERATING

WARNING: If you do not follow these instructions exactly, a fire or explosion may result causing property damage, personal injury or loss of life.

- A. This appliance does not have a pilot. It is equipped with an ignition device which automatically lights the burner. Do not try to light the burner by hand.
- B. BEFORE OPERATING smell all around the appliance area for gas. Be sure to smell next to the floor because some gas is heavier than air and will settle on the floor.
WHAT TO DO IF YOU SMELL GAS
 - Do not try to light any appliance.
 - Do not touch any electric switch; do not use any phone in your building.
 - Immediately call your gas supplier from a neighbor's phone. Follow the gas supplier's instructions.
 - If you cannot reach your gas supplier, call the fire department.
- C. Use only your hand to push in or turn the gas control knob. Never use tools. If the knob will not push in or turn by hand, don't try to repair it, call a qualified service technician. Force or attempted repair may result in a fire or explosion.
- D. Do not use this appliance if any part has been under water. Immediately call a qualified service technician to inspect the appliance and to replace any part of the control system and any gas control which has been under water.

OPERATING INSTRUCTIONS

1. STOP! Read the safety information above on this label.
2. Set the thermostat to lowest setting.
3. Turn off all electric power to the appliance.
4. This appliance is equipped with an ignition device which automatically lights the burner. Do not try to light the burner by hand.
5. Turn gas control knob clockwise  to "OFF" position.
6. Wait five (5) minutes to clear out any gas. Then smell for gas, including near the floor. If you smell gas, STOP! Follow "B" in the safety information above on this label. If you don't smell gas, go to next step.
7. Turn gas control knob  counterclockwise to "ON" position.
8. Turn on all electric power to unit.
9. Set thermostat to desired setting.
10. If appliance will not operate, follow the instructions "To Turn Off Gas To Appliance" and call your service technician or gas supplier.

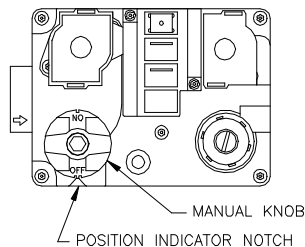

TO TURN OFF GAS TO APPLIANCE

1. Set thermostat to lowest setting.
2. Turn off all electric power to the appliance if service is to be performed.
3. Turn gas control knob clockwise  to "OFF" position.

390434

<p>FOR YOUR SAFETY</p> <p>WHAT TO DO IF YOU SMELL GAS:</p> <ol style="list-style-type: none"> 1. DO NOT TRY TO LIGHT ANY APPLIANCE. 2. DO NOT TOUCH ANY ELECTRICAL SWITCH. DO NOT USE ANY PHONE IN YOUR BUILDING. 3. IMMEDIATELY CALL YOUR GAS SUPPLIER FROM A NEIGHBOR'S PHONE. FOLLOW THE GAS SUPPLIER'S INSTRUCTIONS. 4. IF YOU CANNOT REACH YOUR GAS SUPPLIER, CALL THE FIRE DEPARTMENT. 	<p>FOR YOUR SAFETY</p> <p>DO NOT STORE OR USE GASOLINE OR OTHER FLAMMABLE VAPORS AND LIQUIDS IN THE VICINITY OF THIS OR ANY OTHER APPLIANCE. THIS UNIT MUST BE INSTALLED AND SERVICED BY A QUALIFIED CONTRACTOR ONLY. OPERATING INSTRUCTIONS ARE LOCATED INSIDE APPLIANCE NEAR BURNER ASSEMBLY.</p>
--	--

<p>⚠ WARNING</p>	<p>SPECIAL HOMEOWNERS INSTRUCTIONS</p> <p>● IMPROPER INSTALLATION, ADJUSTMENT, ALTERATION, SERVICE OR MAINTENANCE CAN CAUSE PROPERTY DAMAGE, PERSONAL INJURY OR LOSS OF LIFE.</p> <p>● FOR SAFE OPERATION IT IS THE RESPONSIBILITY OF THE OWNER AND/OR USER THAT THE BURNER, CHIMNEY/VENT PIPE, HEAT EXCHANGER AND CONTROLS SHOULD BE INSPECTED EVERY YEAR BY A QUALIFIED HEATING CONTRACTOR.</p> <p>● THE OWNER AND/OR USER SHOULD ALSO CONDUCT PERIODIC VISUAL INSPECTIONS. REFER TO THE USERS INFORMATION MANUAL PROVIDED WITH THIS FURNACE FOR DETAILS.</p> <p>● ANY DEFICIENCIES NOTED MUST BE CORRECTED AT ONCE BY A QUALIFIED HEATING CONTRACTOR. DO NOT ATTEMPT TO MAKE REPAIRS YOURSELF!</p> <p>● FOR ASSISTANCE OR ADDITIONAL INFORMATION CONSULT A QUALIFIED INSTALLER, SERVICE AGENCY OR THE GAS SUPPLIER.</p>
-------------------------	---

<p>CAUTION</p> <p>MOVING PARTS CAN CAUSE SEVERE PERSONAL INJURY</p> <p>SHUT OFF FURNACE BEFORE REMOVING THIS PANEL.</p>	<p>FILTER MAINTENANCE: WHEN IT BECOMES NECESSARY TO REPLACE OR WASH FILTER REMOVE THE DIRTY FILTER FROM THE RACKS PROVIDED AND WASH OR REPLACE WITH IDENTICAL NEW FILTERS.</p>	<p>DO NOT REMOVE THIS LABEL.</p>
---	--	---

390231

All installations and services must be performed by qualified service personnel.

This page contains various warnings and cautions found throughout the Thermo Pride Highboy and Counterflow Condensing Gas Furnace Manual. Please read and comply with the statements below.

⚠WARNING: IF YOU DO NOT FOLLOW THE SAFETY PRECAUTIONS BELOW AND IN THIS MANUAL, A FIRE OR EXPLOSION MAY RESULT CAUSING PROPERTY DAMAGE, PERSONAL INJURY, OR LOSS OF LIFE.

⚠WARNING: Property damage, personal injury, or loss of life could result from repair or service of this furnace by anyone other than a qualified heating contractor. Only the routine maintenance described in this manual may be performed by the user.

⚠WARNING: To avoid injury from moving parts, shut off the power to the furnace before removing blower compartment door.

⚠WARNING: Keep furnace free and clear of combustible materials, gasoline, and other flammable liquids and vapors.

⚠WARNING: Do not use this furnace if any part has been under water. Immediately call a qualified heating contractor to inspect the furnace and to replace any part of the control system and any gas control which has been under water.

⚠WARNING: If you suspect there is a problem with the furnace, its venting system or any other related problem, immediately contact a qualified service agency.

⚠WARNING: In the event your furnace fails to operate, do not attempt to put the furnace into operation. Contact a qualified heating contractor to service the furnace.

⚠WARNING: A fire or explosion may result causing property damage, personal injury or loss of life if you do not follow these instructions exactly.

⚠WARNING: Homeowners attempting maintenance other than that covered as homeowner/user maintenance may cause conditions which could result in personal injury or property damage.

⚠WARNING: Shut off the power to the furnace before removing blower compartment door to avoid injury from moving parts.

⚠WARNING: This furnace is not to be used for temporary heating of buildings or structures under construction.

⚠WARNING: Call a qualified heating contractor to report suspected deficiencies (Do not attempt to make repairs yourself!)

All installations and services must be performed by qualified service personnel.

II. GENERAL INSTRUCTIONS

1. **⚠WARNING:** Property damage, personal injury, or loss of life could result from repair or service of this furnace by anyone other than a qualified heating contractor. Only the routine maintenance described in this manual may be performed by the user.
2. The following diagrams shows typical furnace installations and the typical position of the components referenced in these instructions.

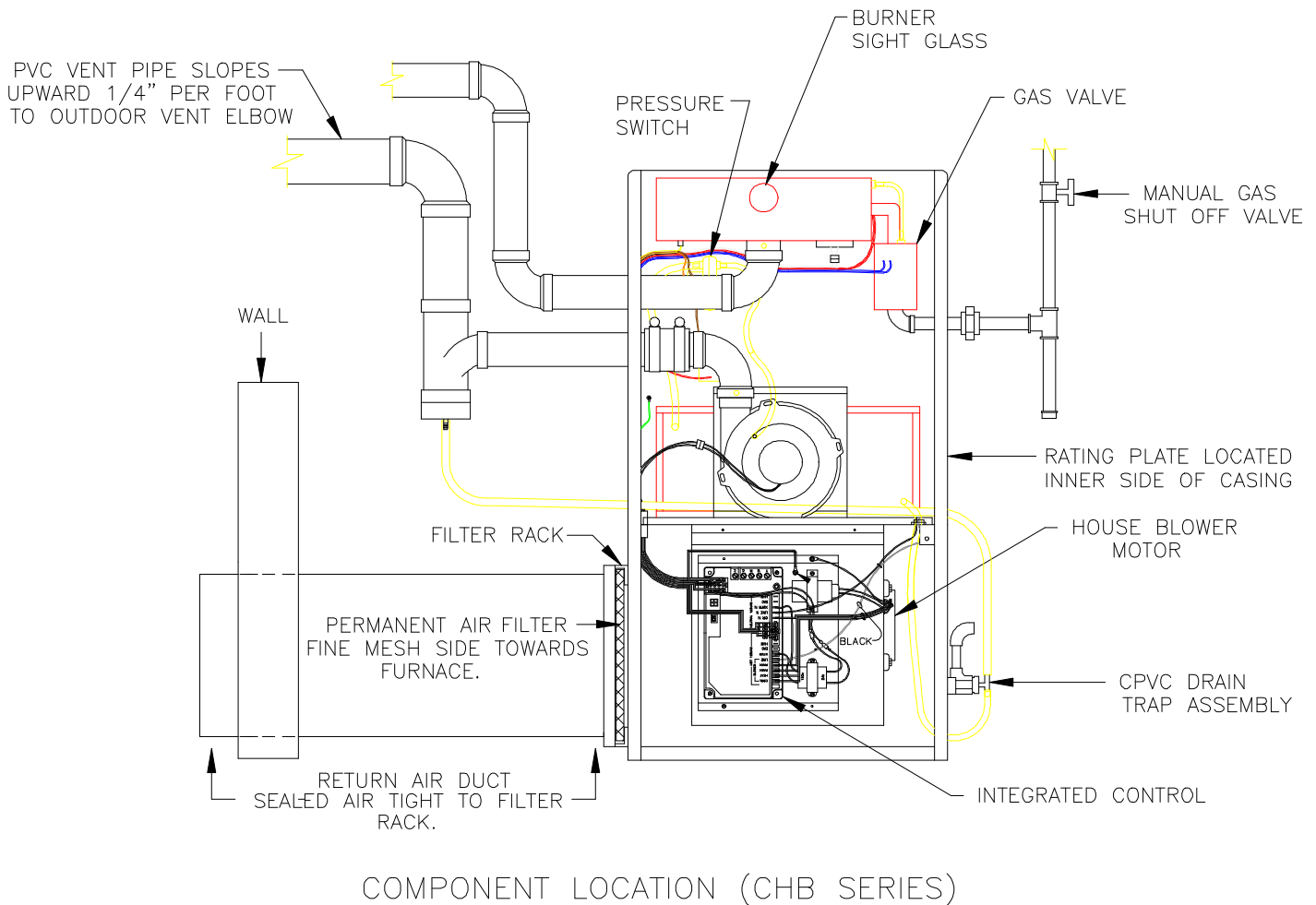
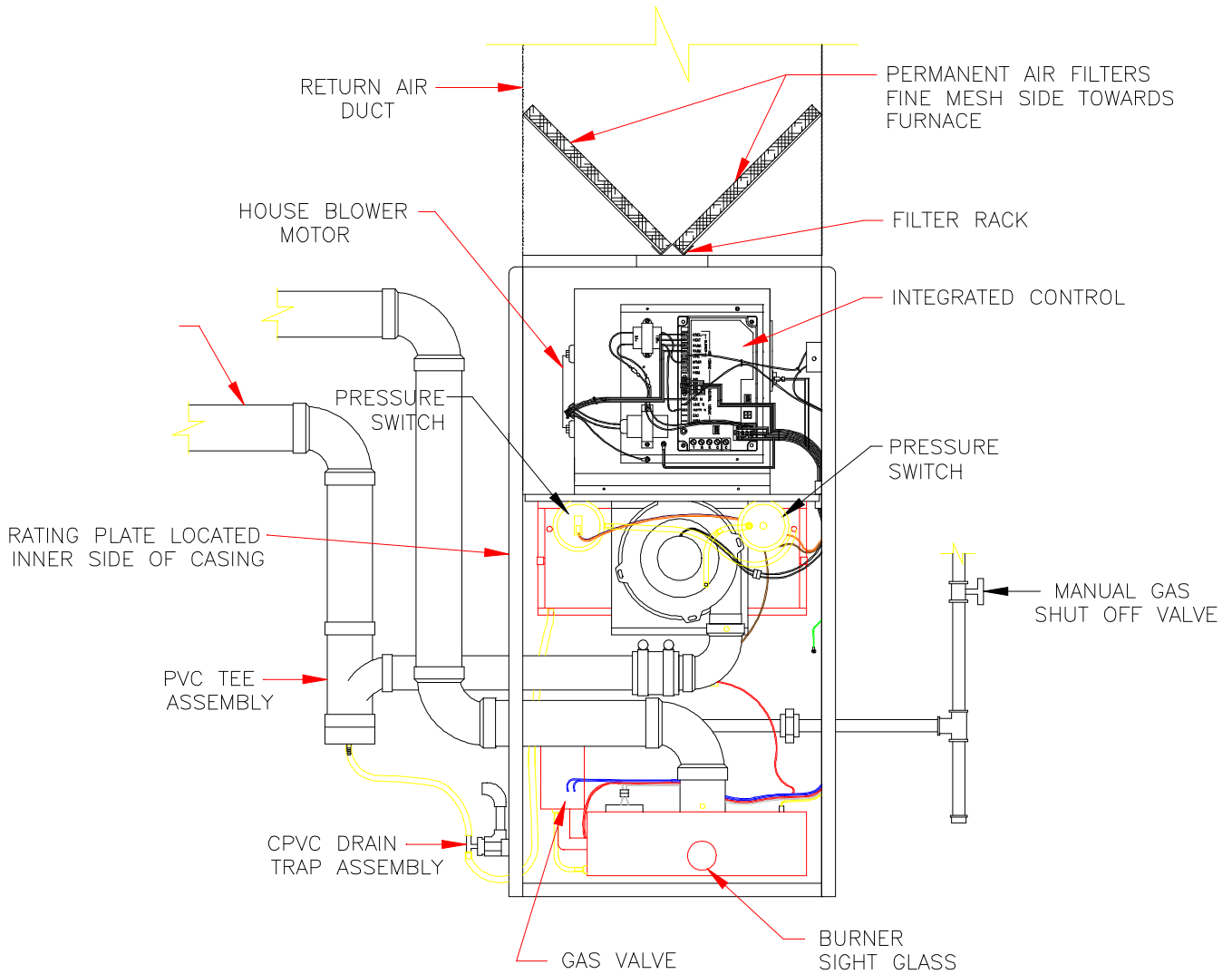

Figure 1.

All installations and services must be performed by qualified service personnel.



COMPONENT LOCATION (CDB SERIES)

Figure 2.

3. **⚠WARNING:** To avoid injury from moving parts, shut off the power to the furnace before removing blower compartment door.
4. **⚠WARNING:** Keep furnace free and clear of combustible materials, gasoline, and other flammable liquids and vapors.
5. The furnace needs air for combustion and ventilation for safe and proper operation.

IMPORTANT: Do not block or obstruct air openings on the furnace, air openings communicating with the area in which the furnace is installed, or the spacings around the furnace.

All installations and services must be performed by qualified service personnel.

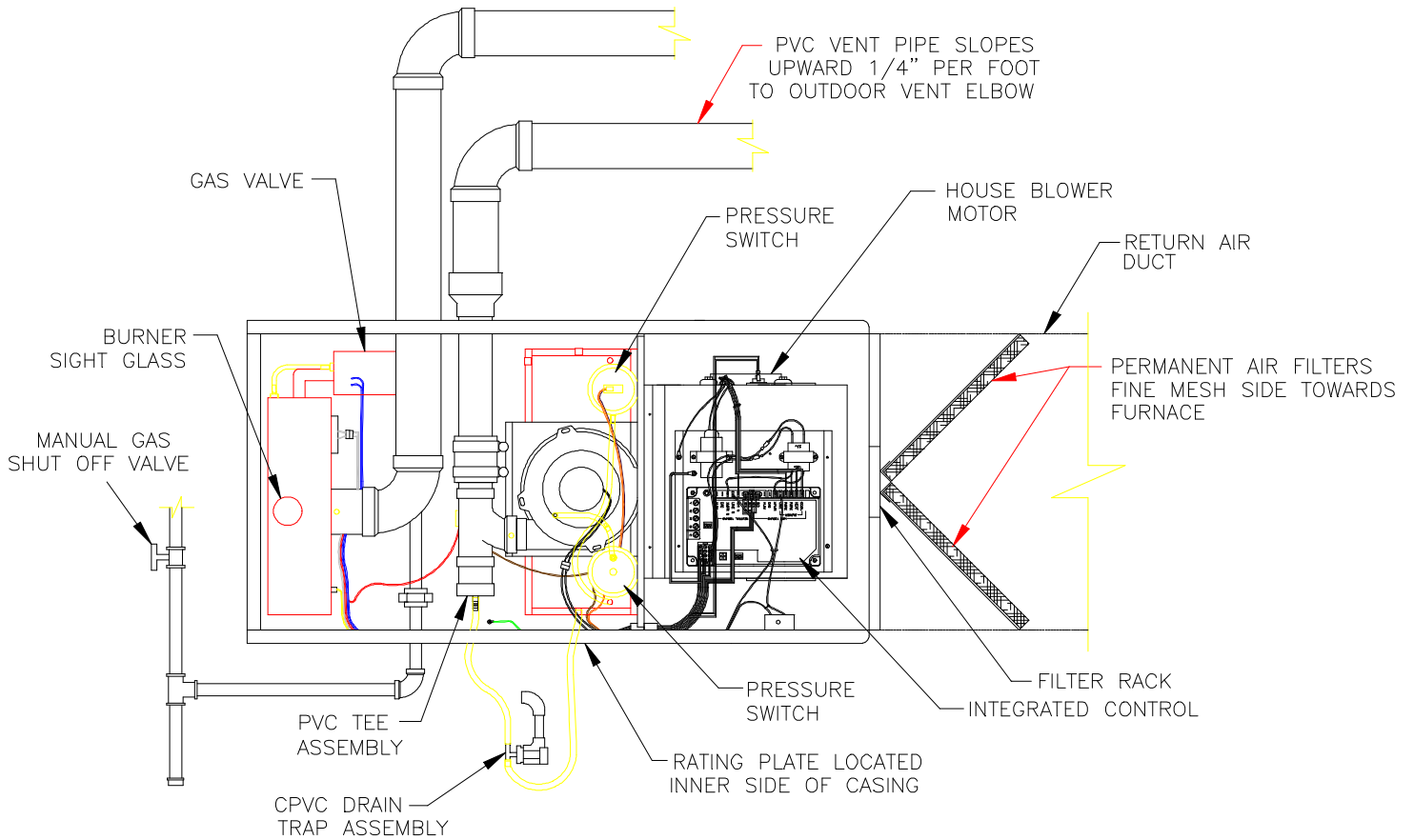

COMPONENT LOCATION
(CDB SERIES SHOWN IN A RIGHT SIDE HORIZONTAL APPLICATION)

Figure 2A.

IMPORTANT: Do not allow the outside vent terminal or air intake to be blocked or obstructed by vegetation, ice, snow or any other materials.

6. This furnace is equipped with a safety feature which will not allow the furnace to be operated if either the inlet or outlet vent to the appliance is blocked.
7. No attempt should be made to restart the unit in the event that gas to the main burner has been shut off. Contact a qualified heating contractor before restarting the furnace.
8. The furnace should be inspected annually by a qualified heating contractor.
9. **⚠WARNING:** Do not use this furnace if any part has been under water. Immediately call a qualified heating contractor to inspect the furnace and to replace any part of the control system and any gas control which has been under water.

All installations and services must be performed by qualified service personnel.

10. Should overheating occur or the gas supply fail to shut off, shut off the manual gas valve to the furnace before shutting off the electrical supply.

⚠WARNING: If you suspect there is a problem with the furnace, its venting system or any other related problem, immediately contact a qualified service agency.

11. Your furnace should be described by the model number and serial number when contacting a qualified heating contractor. This important information is located on the rating plate behind the front door. (See Figures 1 & 2).

12. Should this unit be installed in an attic or other insulated area or if the area is insulated after the furnace is installed, the furnace must be kept free and clear of the insulating material and any fibers that may have come loose. Remember some insulating materials are combustible.

⚠WARNING: In the event your furnace fails to operate, do not attempt to put the furnace into operation. Contact a qualified heating contractor to service the furnace.

III. FURNACE OPERATION

A. WARNINGS BEFORE OPERATING

FOR YOUR SAFETY, READ BEFORE OPERATING

⚠WARNING: A fire or explosion may result causing property damage, personal injury or loss of life if you do not follow these instructions exactly.

A. This appliance does not have a pilot. It is equipped with an ignition device which automatically lights the burner. Do not try to light the burner by hand.

B. **BEFORE OPERATING** - Smell all around the appliance area for gas. Be sure to smell next to the floor because some gases are heavier than air and will settle on the floor.

WHAT TO DO IF YOU SMELL GAS

- * Do not try to light any appliance.
- * Do not touch any electric switch, do not use any phone in your building.
- * Leave the building immediately.
- * Immediately call your gas supplier from your neighbor's phone.
- * Follow the gas suppliers instructions.
- * If you cannot reach your gas supplier, call the fire department.

C. Use only your hand to push in or turn the gas control knob. Never use tools. If the knob will not push in or turn by hand, don't try to repair it, call a qualified heating contractor. Force or attempted repair may result in a fire or explosion.

All installations and services must be performed by qualified service personnel.

B. OPERATING INSTRUCTIONS

TO START THE FURNACE:

1. Please read the safety information in this book before operating furnace.
2. Set the thermostat to the lowest setting.
3. Turn off all electric power to the appliance.
4. Remove the louvered door.
5. Turn the knob clockwise on the combination gas valve to the full off position.

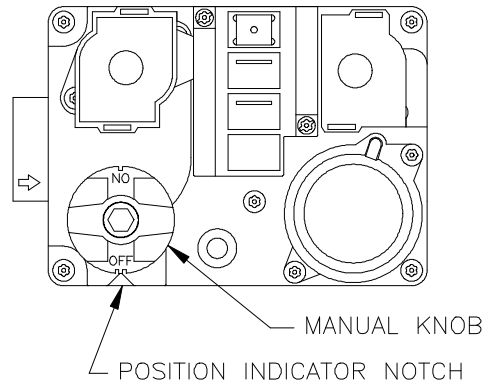

6. Wait five (5) minutes to clear out any gas. If you then smell gas, STOP! Follow Step B in the previous safety information. Go to the next step if you don't smell gas.
7. Turn the knob on combination gas valve to the ON position.
8. Replace front door.
9. Turn on electric power to the appliance.
10. Set thermostat to desired setting.
11. Follow the instructions "To Turn Off Gas To Appliance" and call a qualified heating contractor or gas supplier if the appliance will not operate.

C. SHUTDOWN PROCEDURE

TO TURN OFF GAS TO FURNACE:

1. Set the thermostat to lowest setting.
2. Turn off the electric power to the appliance if service is to be performed.
3. Remove front door.
4. Turn the knob on the combination valve to the full OFF position.
5. Replace front door.

IV. HOMEOWNER/USER MAINTENANCE INSTRUCTIONS (ROUTINE MAINTENANCE)

All installations and services must be performed by qualified service personnel.

The following maintenance procedures should be performed by the homeowner/user during the heating season.

⚠WARNING: Homeowners attempting maintenance other than that covered as homeowner/user maintenance may cause conditions which could result in personal injury or property damage.

⚠WARNING: Shut off the power to the furnace before removing blower compartment door to avoid injury from moving parts.

A. ANNUAL INSPECTION

The homeowner must have this furnace professionally inspected at the beginning of each heating season by a qualified heating contractor to ensure proper operation.

Instructions for the dealer maintenance needed for this furnace can be found in the “Installation and Service Manual.”

NOTICE: This furnace has been shipped from the factory with a permanently lubricated circulating air blower motor. Any maintenance to this blower motor is to be performed only by a qualified heating contractor.

B. FILTER MAINTENANCE PROCEDURE

1. The return air filter provided with this unit is a re-useable type filter. This filter should be inspected monthly. When dirty, the filter must be cleaned or replaced, if necessary, to assure proper furnace operation. Follow the cleaning, removal and replacement procedure below.

NOTICE: If the furnace is installed in a home or structure being remodeled, dust levels may be much higher than normal. The filter must be inspected daily and cleaned as needed until dusty conditions have been eliminated. Any replacement motors not obtained through Thermo Products should be lubricated according to the motor name plate.

⚠WARNING: This furnace is not to be used for temporary heating of buildings or structures under construction.

CHB FURNACE

The filter rack or drop chute will be located between the return air plenum and the return air opening of the furnace (See Figure 3). Slide dirty filter out of the filter rack. Clean the filter by vacuuming, rinsing with tap water, hosing or dipping in an ordinary detergent solution. Replace the completely dry filter in the rack. The mesh side of the filter must be installed towards the furnace after cleaning.

All installations and services must be performed by qualified service personnel.

CDB FURNACE

TURN OFF POWER TO FURNACE. The filter rack will be located on top of the furnace inside the return air duct using either a V-rack or a drop chute similar to one shown for the CHB in Figure 3. To change filter with a front load type drop chute, follow the instructions for a CHB. To change filters using the V-rack, remove the furnace front door and remove the filters through the blower opening (or in the event access slots are provided in the plenum, pull the filters directly out through these slots). Clean filters by vacuuming, tap water rinsing, hosing or dipping in an ordinary detergent solution. After cleaning, replace completely dry filter, mesh side down on the filter rack on the top of the furnace. Replace front door. Turn on power to furnace.

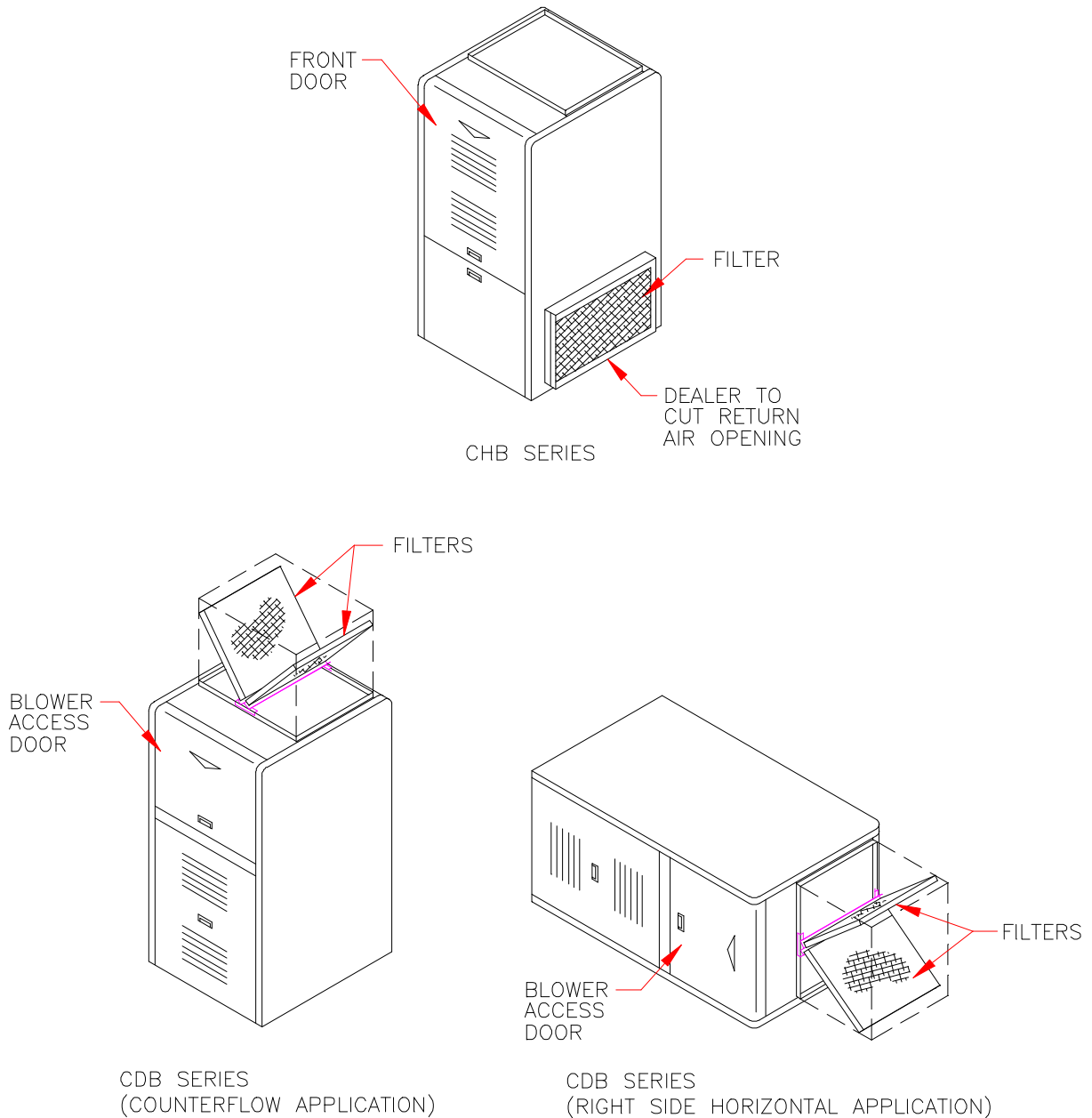

Figure 3.

All installations and services must be performed by qualified service personnel.

FILTER REPLACEMENT

See Table 1 for minimum heating filter areas required for the different types of filters available should the filter used require replacement.

If the unit is equipped with cooling, contact your installer or a qualified service person to determine the minimum filter area required for the different filter types and your cooling system.

MINIMUM FILTER AREA REQUIRED (LENGTH X WIDTH, SQ. IN.)

FILTER TYPE	MAXIMUM RATE AIR VELOCITY	FURNACE MODEL			
		CHB,CDB50	CHB,CDB75	CHB,CDB100	CHB,CDB125
*THERMO PRODUCTS SUPPLIED PERMANENT FILTER	600 FT./MIN.	172 IN. ²	254 IN. ²	328 IN. ²	402 IN. ²
STANDARD PERMANENT FILTER	500 FT./MIN.	208 IN. ²	304 IN. ²	394 IN. ²	484 IN. ²
DISPOSABLE TYPE FILTER	300 FT./MIN.	344 IN. ²	506 IN. ²	656 IN. ²	804 IN. ²

TABLE 1

* The Thermo Products supplied filter can be cut to size to fit other filter retention systems as long as the minimum size requirement is met. **NOTICE:** Any internal stiffeners used in the filter must not be removed, although they can be cut to the length required.

C. VISUAL INSPECTION PROCEDURE

It is recommended that the homeowner/user conduct the following periodic visual inspection of the furnace at the start of the heating season and monthly during the heating season.

WARNING: Call a qualified heating contractor to report suspected deficiencies (Do not attempt to make repairs yourself!)

1. Turn off power to furnace.
2. Vent pipe, air intake pipe, and condensate system: Visually check the vent and intake pipe as well as condensate lines both inside and outside the furnace to make sure that vent intake joints and the condensate system are sealed. There should be no sign of water leakage at any vent intake or condensate joints or anywhere inside the furnace. Make sure that horizontal runs of vent pipe slope upward towards the outside. The inlet pipe should slope slightly downward to prevent

All installations and services must be performed by qualified service personnel.

condensate build up. Any signs of damage, leakage, deterioration, or possible blockage should be immediately reported to your dealer or the local gas company.

It is recommended that the condensate removal system be cleaned annually by a qualified service agency to insure its proper and continued operation.

Outside vent and outside combustion air termination: the outside vent terminations should be inspected to insure that they are clear and free of obstruction by ice, snow, debris, or vegetation. Any obstruction of the terminal should be carefully removed without damaging the vent terminal. If ice has formed on the outside terminals themselves, it should be removed.

3. If the furnace is equipped with a Thermo Products, Inc. condensate neutralizer kit, (See Figure 4) it should be inspected at the start of every heating season. Remove the 2" PVC cap from the neutralizer kit and replace dissolved filter material with #9 limestone. Keep instructions for neutralizer kit in plastic pouch on the inside of the furnace blower door.

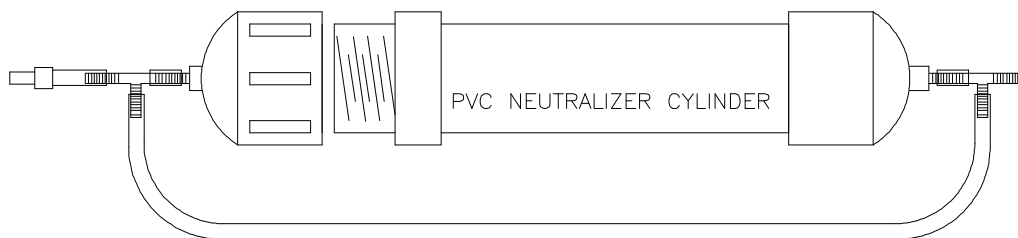

Figure 4.

4. Return Air Duct Connection: Check to see if it is (1) physically sound; (2) sealed to the furnace casing; and (3) terminates outside the space containing the furnace.

5. Make sure the furnace is sealed to the base (if applicable) without sagging, cracks or gaps. Make sure there are no signs of deterioration of the furnace or base.

6. Examine the entire furnace, including removing the vestibule door and inspect the control compartment and the furnace for signs of damaged or unusually worn wiring, condensation, sooting or other damage or deterioration.

7. Restore power to the furnace. Follow the operating instructions to light furnace.

8. Make sure the burner flames are in good adjustment (See Figure 5). Burner flames should not impinge or fire against the side of the tube opening.

NOTICE: It is not unusual to have orangish flames visible in the tube for LP gas.

All installations and services must be performed by qualified service personnel.

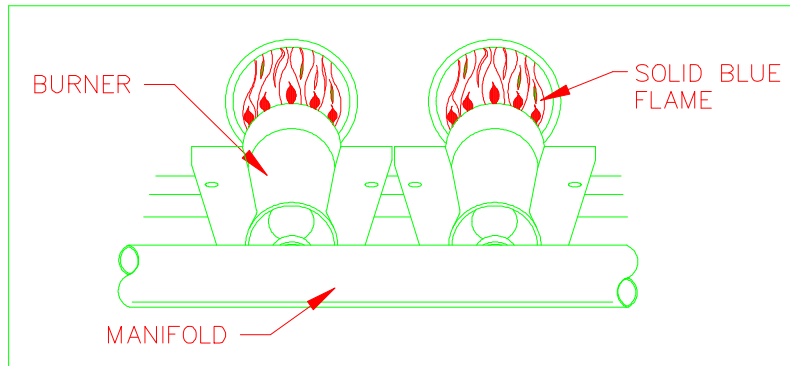

Figure 5.

⚠WARNING: Call a qualified heating contractor to report suspected deficiencies (do not attempt to make repairs yourself!)