



SERVICE MANUAL

HWH® TOUCH PANEL-CONTROLLED 305/325 SERIES LEVELING SYSTEM

FEATURING:

*Touch Panel Leveling Control
BI-AXIS® Hydraulic Leveling
Central Grounding
Straight-Acting Jacks
With or Without Air Dump*

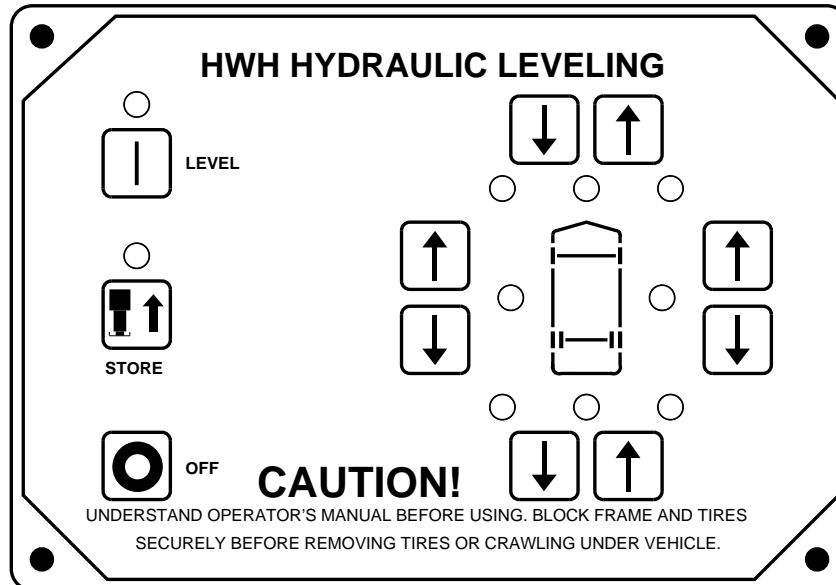

HWH CORPORATION
(On I-80, Exit 267 South)
2096 Moscow Road | Moscow, Iowa 52760
Ph: 800/321-3494 (or) 563/724-3396 | Fax: 563/724-3408
www.hwh.com

SECTION 1

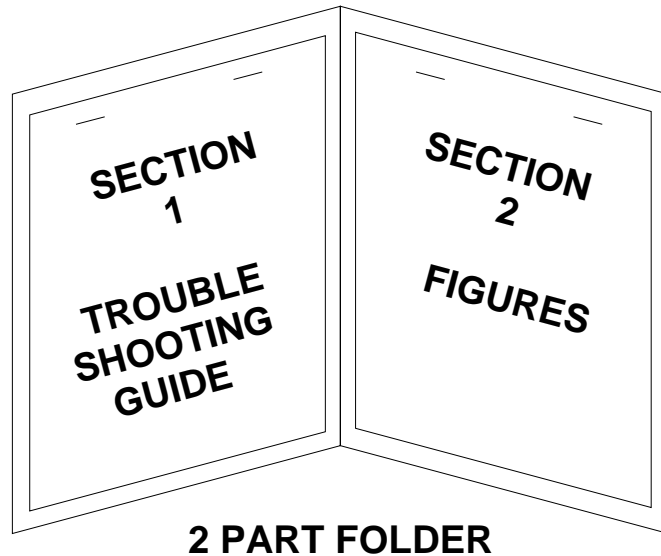

HOW TO USE MANUAL

This manual is written in two sections. Section 1 is the Trouble Shooting Guide. Section 2 is the figures. Begin diagnosis of the system with Section 1, the Trouble Shooting Guide. The Trouble Shooting Guide describes system operation with each phase of operation followed by symptoms of possible problems. The problem section is broken into 3 columns, Problem, Solutions and Figures. Under Problems, find the symptom you have encountered. The testing and repair for that problem is in the Solution (center) column. Diagrams for a particular Problem and Solution are in the Figures (right hand) column. This column will direct you to the proper figure in Section 2, Figures, for a more detailed view.

Before beginning your repair, it is **IMPORTANT** to read the **CAUTIONS** and **NOTES AND CHECKS** in the first section, **TROUBLE SHOOTING GUIDE**. In many cases this will save time and mistakes when trouble shooting a system.

This Repair Manual is offered as a guide only. It is impossible to anticipate every problem or combination of problems. For any problems encountered that are not addressed in this manual, contact HWH Corporation for assistance. (800-321-3494)

PROCEED WITH TROUBLE SHOOTING GUIDE



TROUBLE SHOOTING

WARNING!

BLOCK FRAME AND TIRES SECURELY BEFORE CRAWLING UNDER VEHICLE. DO NOT USE THE LEVELING JACKS OR AIR SUSPENSION TO SUPPORT VEHICLE WHILE UNDER VEHICLE OR CHANGING TIRES. VEHICLE MAY DROP AND OR MOVE FORWARD OR BACKWARD WITHOUT WARNING CAUSING INJURY OR DEATH.

WHEN ROUTING OR REROUTING HYDRAULIC HOSES AND WIRES, BE SURE THEY ARE NOT EXPOSED TO ENGINE EXHAUST OR ANY HIGH TEMPERATURE COMPONENTS OF THE VEHICLE.

NEVER PLACE HAND OR OTHER PARTS OF THE BODY NEAR HYDRAULIC LEAKS. OIL MAY CUT AND PENETRATE THE SKIN CAUSING INJURY OR DEATH.

SAFETY GLASSES ARE TO BE WORN TO PROTECT EYES FROM DIRT, METAL CHIPS, OIL LEAKS, ECT. FOLLOW ALL OTHER SHOP SAFETY PRACTICES.

NOTES AND CHECKS

Read and check before proceeding with Trouble Shooting Steps.

NOTE: HWH CORPORATION ASSUMES NO LIABILITY FOR DAMAGES OR INJURIES RESULTING FROM THE INSTALLATION OR REPAIR OF THIS PRODUCT.

1. If the jacks cannot be retracted, see TROUBLE SHOOTING Step 4h for temporary measures. Make sure the manual retract valves are closed before trouble shooting.

2. The Trouble Shooting Guide must be followed in order. Problems checked for in one step are assumed correct and may not be checked again in following steps.

3. Check that the oil reservoir is full with the jacks in the fully retracted position. If the vehicle is equipped with HWH room extensions, refer to the HWH Owners Manual for proper position of the room when checking the oil level.

4. Most coaches have more than one battery; one for the engine and the other(s) for the coach. The engine battery supplies power for the control box and hydraulic pump. Batteries under no load should read 12.6 volts. Batteries must maintain good voltage under load. Batteries must be in good condition with no weak cells. An alternator, converter or battery charger will not supply enough power for the system to operate properly.

5. Proper grounding of all components is critical. See the electrical circuit for specific grounds required. Faulty grounds, especially for the control box, solenoid manifold or the pump assembly, may cause control box component damage and /or improper or erratic operation.

6. Do not replace the control box unless the Repair Steps say to replace it. Otherwise the malfunctions may damage the new control box.

This manual is intended for use by experienced mechanics with knowledge of hydraulic and automotive electrical systems. People with little or no experience with HWH leveling systems should contact HWH technical service (800-321-3494) before beginning. Special attention should be given to all cautions, wiring, and hydraulic diagrams.

Special note: When installing a new control box, make sure the box is properly grounded before applying power to the system.

Tightening of hose ends: If tightening a new hose end, make the hose end snug (finger tight) on the fitting, then tighten the hose end 1/3 turn (2 FLATS). If tightening an existing hose end, tighten the hose end to snug plus 1/4 turn (1 FLAT).

Suggested tools for trouble shooting the HWH leveling systems:
JUMPER WIRES (UP TO 10 GAUGE)
PRESSURE GAUGE (3500 PSI MIN.)
MULTI-METER
12 VOLT TEST LIGHT

PROCEED WITH THE TROUBLE SHOOTING STEPS ON THE FOLLOWING PAGE



CONTROL IDENTIFICATION

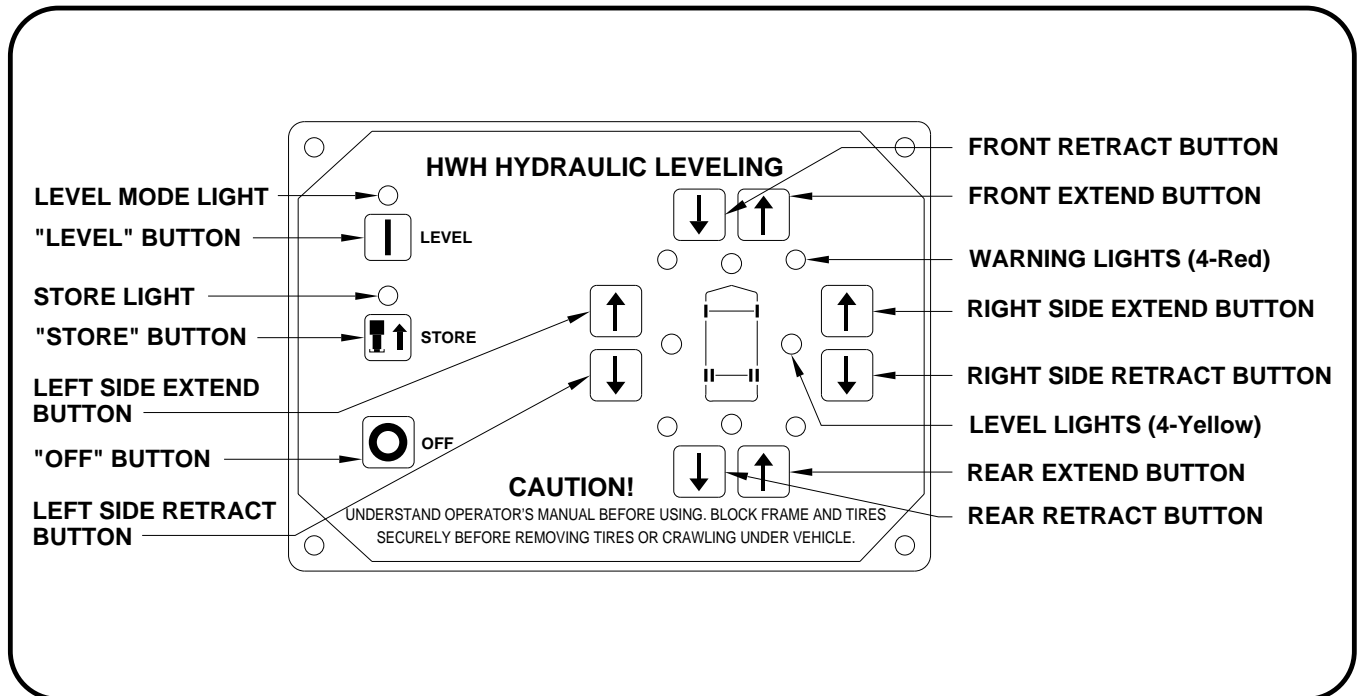

CONTROL FUNCTIONS

CONTROL BUTTONS

"LEVEL" BUTTON: This button places the system in leveling mode.

"OFF" BUTTON: This button turns off control power to the leveling system.

"STORE" BUTTON: This button will retract all four jacks. (The panel must be off before pressing the "STORE" button)

EXTEND BUTTONS (UP ARROWS): These buttons will extend their respective jack pairs to lift the vehicle.

RETRACT BUTTONS (DOWN ARROWS): These buttons will retract their respective jack pairs to lower the vehicle.

FRONT - Right Front and Left Front jacks.

RIGHT SIDE - Right Front and Right Rear jacks.

LEFT SIDE - Left Front and Left Rear jacks.

REAR - Left Rear and Right Rear jacks.

INDICATOR LIGHTS

LEVEL MODE LIGHT: This light indicates the system is in the leveling mode.

STORE LIGHT: This light will be on when the system is in the store mode.

LEVELING LIGHTS: If a yellow LEVELING light is on, that indicates a side, corner, or end of the vehicle is low. Extend the appropriate jack pairs to put out the yellow light. One or two yellow LEVELING lights can be on at a time. The vehicle is level when all yellow lights are out.

WARNING LIGHTS: A red WARNING light will be on whenever the corresponding jack is extended approximately 1/2 inch, provided the ignition is in the "ACC" or "ON" position. Some vehicles are equipped with a dash mounted master "JACKS DOWN" light which will be on when one or more jacks are extended approximately 1/2 inch and the ignition is in the "ON" position.

WARNING BUZZER: A buzzer will sound if a jack is extended approximately 1/2 inch or more and the ignition switch is in the "ON" position.

TROUBLE SHOOTING

The 325 series leveling system is a manually operated system. Push and hold the Up Arrow (EXTEND) buttons and Down Arrow (RETRACT) buttons to operate the jacks.

The jacks will always extend in pairs both front, both rear, right front and right rear or left front and left rear. When testing the system, always operate all 4 sets of buttons. This assures the correct pair of jacks will extend or retract when their button is pushed.

Vehicles with an active air suspension will have an air dump system. This will be an HWH system with several normally closed dump valves or a factory installed pilot air dump system which is part of the chassis equipment. This manual will discuss diagnostics of each.

If the vehicle is equipped with a pilot air dump system, the diagnostics for HWH is limited to a +12 Travel or Dump signal from the HWH Touch Panel and Control Box. Refer to the chassis manufacturer for the correct procedures when working on the chassis pilot dump equipment.

In the following repair guide, each "Part" describes an operation or function of the leveling system. Below each "Part" there are three columns. The left hand column describes a possible symptom. The center column gives a diagnostic procedure and solution. The right hand column shows a diagram or refers to a diagram in the diagram section.

It is important to remember it is possible to encounter a problem not listed in this guide. If this occurs, contact HWH Corporation Customer Service for assistance.

Part 1. Make sure the transmission is in the recommended position for parking and the park brake is set. With the ignition off, there should be no power to the leveling system. There should be no Touch Panel lights on. The pump should not be running.

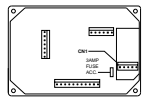
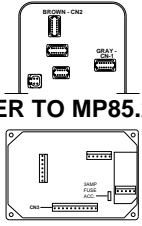
PROBLEM	SOLUTION	DIAGRAM
1a. The Touch Panel has a light on or can be turned on with the ignition off.	Wire number 6122 on PIN 1 of CN1 on the touch panel should be connected to a +12 source on the accessory side of the ignition switch. There should be no power on this wire with the ignition off.	 <p style="text-align: center;">REFER TO MP85.192C</p>
1b. The pump runs continuously.	Unplug CN2 from the control box. If the pump continues to run, the pump relay is stuck and needs to be replaced. If the pump stops running, unplug CN1 from the control box and plug CN2 back in. If the pump starts running the control box is bad. If the pump does not run unplug CN3 from the touch panel and plug CN1 back in. If the pump runs wire 8600 in the harness is shorted to ground. If the pump does not run, the touch panel is the problem.	 <p style="text-align: center;">REFER TO MP85.206C</p> <p style="text-align: center;">REFER TO MP85.192C</p>

Part 2. Turn the ignition switch to the "ACC" position. The touch panel should remain off.

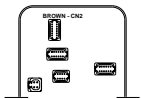
PROBLEM	SOLUTION	DIAGRAM
2a. The Level Mode light and/or other are on.	Push the "OFF" button. If panel lights stay on, replace the touch panel.	
2b. The pump runs at this time.	Unplug CN2 from the control box if the pump continues to run, replace the control box. If the pump stops, replace the Touch Panel.	 <p style="text-align: center;">REFER TO MP85.206C</p>

Part 3. With the ignition in the "ACC" position, push the "LEVEL" (I) button. The red LEVEL MODE light should glow steady. One or two yellow LEVEL lights may be on. No other lights should be on. The pump should not run. If the vehicle is equipped with an air suspension, the air will dump from the suspension when the Touch Panel is turned on. If the Touch Panel comes on but will not dump at this time, see part 6.

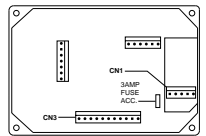
PROBLEM	SOLUTION	DIAGRAM
3a. The Level Mode light will not come on when the LEVEL button is pushed.	Check PIN 1 wire number 6120 of connector CN1 of the Touch Panel. There should be a good +12 volt signal with the ignition in the "ACC" position. Check PIN 3 wire number 6230 of connector CN3 of the Touch Panel. This should be a good ground. If +12 volts and ground is present, replace the Touch Panel.	 <p style="text-align: center;">REFER TO MP85.192C</p>

TROUBLE SHOOTING

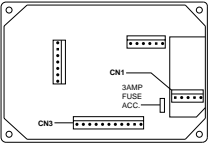
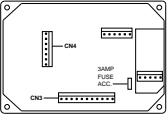
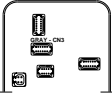
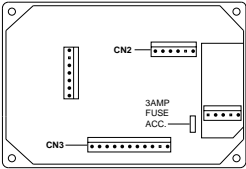
PROBLEM	SOLUTION	DIAGRAM
<p>3b. The LEVEL MODE light will come on but will not stay on when the LEVEL button is released.</p>	<p>Use a volt meter to check between PIN 1 of connector CN1 and PIN 3 of connector CN3 of the Touch Panel while pushing the LEVEL button. If there is less than 11 volts, there is a wire, connection or battery problem. If there is 12 + volts while pushing the LEVEL button, replace the Touch Panel.</p>	 <p style="text-align: center;">REFER TO MP85.192C</p>
<p>3c. More than two or opposite yellow level lights are on.</p>	<p>With the panel on, unplug the Sensing Unit connector, CN4. Use a test light to ground pins 2 (rear), 3 (right side), 4 (front) and 5 (left side). If the correct light does not come on at once replace the Touch Panel. If the Touch Panel works properly, plug in CN4 at the Touch Panel and unplug CN3 at the Control Box. Use a test light to ground PIN 1 (rear), 2 (right side), 3 (front) and 4 (left) of the harness plug. If the correct light does not come on or two lights come on, the harness is the problem. If the panel lights work properly, replace the Sensing Unit.</p>	 <p style="text-align: center;">REFER TO MP85.192C</p>  <p style="text-align: center;">REFER TO MP85.206C</p>
<p>3d. A red warning light is on, no jacks are extended.</p>	<p>Unplug the CN2 connector at the Touch Panel. If the warning light remains on, replace the Touch Panel. If the warning light(s) goes out, plug the CN2 connector back in and unplug the warning switch at the jack. If the warning light remains on, the harness is bad. If the light goes out the problem is probably the warning switch. If a new switch does not fix the problem the magnet in the cylinder may be bad.</p> <p>NOTE: Make sure the white wires of the harness and warning switch are in the "A" pins of the Packard connectors. The black wires must be in the "B" pins of the connectors.</p>	 <p style="text-align: center;">REFER TO MP85.192C</p>
<p>3e. The pump runs when the touch panel is turned on.</p>	<p>Replace the touch panel.</p>	
<p>3f. The air will not dump from the suspension when the Touch Panel is turned on.</p>	<p>See Part 6 of the TROUBLE SHOOTING STEPS.</p>	

TROUBLE SHOOTING

The jacks operate in pairs, front, side and rear. UP ARROWS - EXTEND and DOWN ARROWS - RETRACT the jacks.

Part 4. Push and hold the front UP ARROW, both front jacks should extend. At approx. 1/4" to 1/2" extension each red Warning light should come on. **One jack may reach the ground and even lift the vehicle slightly before the other.** With both jacks extended to the ground and lifting the vehicle release the UP ARROW, both jacks should remain extended. Push and hold the front DOWN ARROW, both front jacks should retract. Within 1/4" to 1/2" of complete retraction each red Warning light should go out.

Repeat the process with each set of UP and DOWN ARROWS making sure the correct pair of jacks extend and retract properly. Three or four jacks should never extend at the same time.

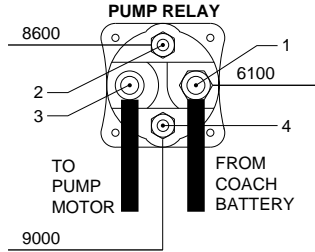
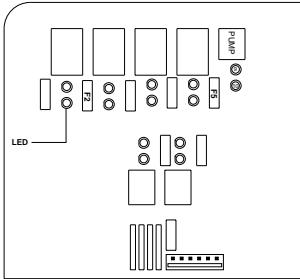
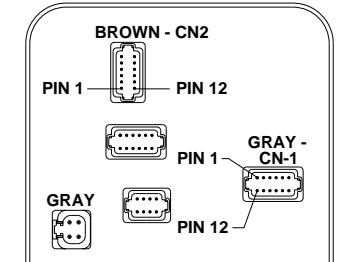
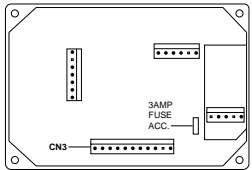
PROBLEM	SOLUTION	DIAGRAM
<p>4a. The Panel is on, the pump does not run when the UP ARROW is pushed. (Try a different UP ARROW. If the pump runs replace the Touch Panel.)</p>	<p>While the UP ARROW is pushed, there should be +12 volts on terminals 1,2 and 3 of the pump relay. Terminal 4 is a ground supplied by the park brake switch. Terminal 1 is battery power to the relay. Terminal 2 is switched +12 power to the pump motor. (Make sure all pump assembly mounts are tight and that the assembly has a adequate ground for the pump motor.) Terminal 3 is switched +12 volts to control the relay. Terminals 1,2 and 3 should have a minimum of 9.0 volts when trying to run the pump.</p> <p>Check LED 9 (yellow) and LED 10 (red) for the pump relay in the Control Box. If both LED's are lit: Check terminal 3 of the pump relay. If power is present skip to the next paragraph. If power is not present the problem is with the connections (CN2-PIN 12) or the wire (8600). If the yellow LED is lit but not the red: Check the fuse. If the fuse is OK, check the 6100 wires in the 4 PIN gray connector for +12 volts. If voltage is present, replace the Control Box. If voltage is not present, the problem is the 6100 wire, connections at the pump relay or no power from the battery. Check that the CN2 brown connector is plugged in properly. This connector can be plugged in upside down. If the fuse is bad, the problem is the 8600 wire or the pump relay. If the yellow LED is not lit: Check CN1 PIN 12 of the control box for 12 volts and PIN 11 for ground. If PIN 12 has +12 volts and PIN 11 has a ground replace the Control Box. If PIN 12 has no voltage check CN3 PIN 1 at the Touch Panel. If voltage is present the problem is the connection or wire (6120) of that harness. If voltage is not present, replace the Touch Panel. If PIN 11 (CN1) of the control box has no ground, check CN3 PIN 10 at the Touch Panel. If PIN 10 has a ground the problem is the connections or wire (8600). If PIN 10 has no ground, replace the Touch Panel.</p> <p>If there is no power on terminal 1 check connection to the battery, the battery and the ground connections for the battery.</p> <p>If there is power on terminals 1,2 and 3 the problem is connections to the pump motor or the pump motor itself.</p> <p>If there is power on terminals 1 and 3, ground on terminal 4, but no power on terminal 2 the pump relay is bad.</p> <p>If there is no ground on terminal 4, check CN2 PIN 7. If ground is present, the connections or wire (9000) is the problem. If there is no ground on PIN 7, check CN1 PIN 7 for ground. If there is a ground, replace the Control Box. If there is no ground in PIN 7 (CN1) the problem is the connections, wire (9000) or the park brake circuit.</p> <p>Note: Make sure all connections at the relay are clean and tight. Corrosion that may not be visible can cause problems at the relay. Remember, the UP ARROW must be pushed when testing the relay.</p>	<div style="text-align: center;">  <p>REFER TO MP85.2195</p> </div> <div style="text-align: center;">  <p>REFER TO MP85.212C</p> </div> <div style="text-align: center;">  <p>REFER TO MP85.206C AND REFER TO MP85.207C</p> </div> <div style="text-align: center;">  <p>REFER TO MP85.192C</p> </div>

TROUBLE SHOOTING

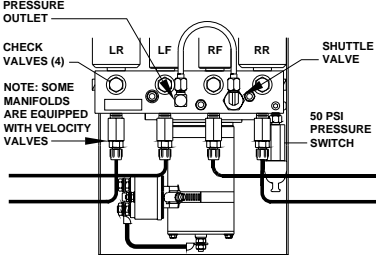
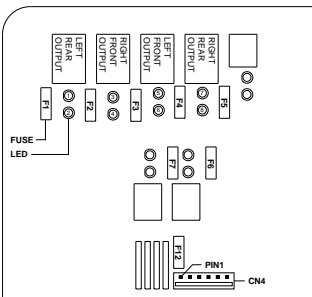
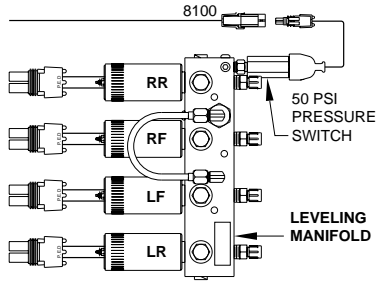
PROBLEM	SOLUTION	DIAGRAM
<p>4b. The jack(s) will not extend or will extend but will not lift the vehicle. The pump runs under no load.</p>	<p>If the pump is running under no load the problem is the pump or the shuttle valve. Connect a 5000 PSI pressure gauge to the pressure outlet fitting on the manifold. Run the pump. The pump pressure should be 3500 PSI. Check the voltage at the pump while the pump is running. If the voltage is under 10 volts the pump pressure may be low. The minimal allowable pressure would be 3300 PSI. The maximum allowable pressure would be 3800 PSI. The pumps have an adjustable relief valve. If proper pressure cannot be achieved, replace the pump.</p>	 <p style="text-align: center;">REFER TO MP65.270C</p>
<p>4c. No jacks will extend, the pump runs under load.</p>	<p>The problem is most likely the 50 psi manifold pressure switch but could be the shuttle valve, control box, touch panel or touch panel cable.</p> <p>Left Front - LED's 5 and 6 Right Front - LED's 3 and 4 Right Rear - LED's 7 and 8 Left Rear - LED's 1 and 2</p> <p>If the YELLOW and RED LED's come on while pushing the "DOWN" arrows, the touch panel and touch cable are OK.</p> <p>If the LED's come on refer to problem 4b and check the pump pressure and voltage. If the pump pressure and voltage is OK, open any valve release T-Handle or nut. Push the appropriate "UP" arrow for that jack. If the jack does not extend, the problem is the shuttle valve. If the jack extends, unplug the 50 PSI manifold pressure switch and close the valve releases on the solenoid valves. Ground the 8100 wire and try any "UP" arrow. If the jacks extend, replace the pressure switch. If the jacks do not extend the problem is the 8100 wire, it's connections or the control box. Check for continuity between the two pins for the 8100 wire. If the wire and connections are OK replace the control box.</p> <p>If after replacing the control box the jacks will still not extend, refer to part 4d and check individual pairs of jacks.</p>	 <p style="text-align: center;">REFER TO MP85.212C</p>  <p style="text-align: center;">REFER TO MP85.2195</p>

TROUBLE SHOOTING

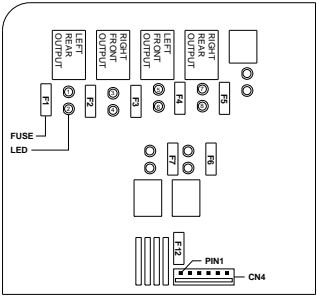
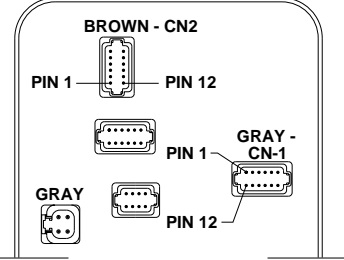
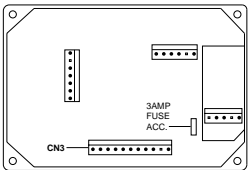
PROBLEM	SOLUTION	DIAGRAM
<p>4d. One or more jacks or the correct jacks will not extend when an "UP" arrow is pushed. Other jacks extend OK.</p> <p>NOTE: Remember when referring to 4d from 4c, the manifold pressure switch and shuttle valve have been checked and are OK.</p>	<p>Check the YELLOW and RED LED's for the jack(s) that won't extend while the UP ARROW is being pushed.</p> <p>Left Rear - LEDs 1 and 2 Right Front - LEDs 3 and 4 Left Front - LEDs 5 and 6 Right Rear - LEDs 7 and 8</p> <p>If the YELLOW and RED LED's are both lit or the YELLOW LED's are lit but not the RED LED's the problem is between the control box and the hydraulic manifold.</p> <p>If the YELLOW and RED LED's are not lit, the problem is between the control box and the touch panel.</p> <p>Note: Remember when checking for voltage or ground all harnesses must be plugged in and the correct UP ARROW must be pushed.</p> <p>The signal between the touch panel and the control box to run the pump and solenoid valves is a ground signal. The signal between the control box and the pump relay or jack solenoid valves is a +12 volt signal.</p> <p>If the YELLOW and RED LED's are lit check the correct pins in the BROWN CN2 connector for +12 and ground. If +12 or ground is not present replace the control box. If +12 and ground is present check for +12 and ground at the solenoid valve. If +12 or ground is not present the harness is the problem. If +12 and ground is present at the solenoid valve, replace the solenoid valve.</p> <p>If the YELLOW LED is lit but not the RED LED, check the fuse for that valve. If the fuse is OK, replace the box. If the fuse is blown, the problem is a short in the harness or a bad solenoid valve.</p> <p>If neither the YELLOW LED or the RED LED is lit, check for a ground on the correct pin in the CN1 GRAY 12 pin connector at the control box. If a ground is present, replace the control box. If a ground is not present, check for a ground on the correct pin in the CN3 - 11 pin connector at the touch panel. If a ground is present, the problem is the harness or harness connections. If a ground is not present, replace the touch panel.</p>	<div style="text-align: center;">  <p>REFER TO MP85.212C</p> </div> <div style="text-align: center;">  <p>REFER TO MP85.206C</p> </div> <div style="text-align: center;">  <p>REFER TO MP85.192C</p> </div>

TROUBLE SHOOTING

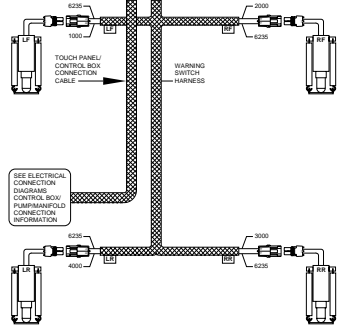
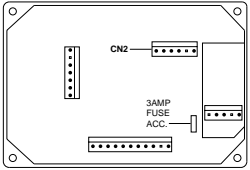
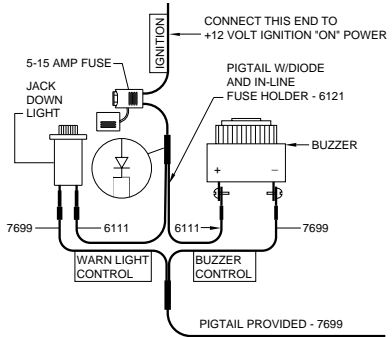
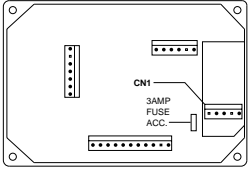
PROBLEM	SOLUTION	DIAGRAM
<p>4e. The red WARNING light on the Touch Panel will not come on as it's jack starts to extend.</p> <p>The ignition must be on while testing warning switches.</p>	<p>Unplug the warning switch at the jack. Short the two pins in the harness plug together. If the warning light comes on, replace the warning switch. (Retract the jacks before removing the warning switch.) If the warning light does not come on, ground the pin for the black wire in the harness. If the warning light comes on, the problem is the white ground wire or it's connections. If the light does not come on, ground the correct pin in the CN2 connector at the touch panel. If the warning light comes on, there is a connection or harness problem. If the warning light does not come on, replace the touch panel.</p>	 <p style="text-align: center;">REFER TO MP85.047C</p>  <p style="text-align: center;">REFER TO MP85.192C</p>
<p>4f. The Master Warning light and/or buzzer will not come on when a Touch Panel warning light is on.</p> <p>The ignition must be on.</p>	<p>Check for +12 power at the warning light and buzzer. If +12 is not present, trace the wire to it's source. If the fuse is blown, the +12 supply wire is shorted to ground. If +12 is present at the warning light and buzzer, check for a ground on PIN 4, CN1 of the touch panel. If ground is not present replace the touch panel. If ground is present, check for a ground at the warning light and buzzer. If a ground is present, the problem is the light or buzzer. If a ground is not present, the problem is a connection or the 7699 wire.</p>	 <p style="text-align: center;">REFER TO MP85.304Q</p>  <p style="text-align: center;">REFER TO MP85.192C</p>

TROUBLE SHOOTING

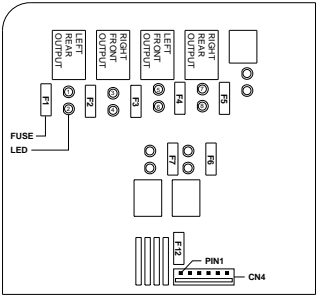
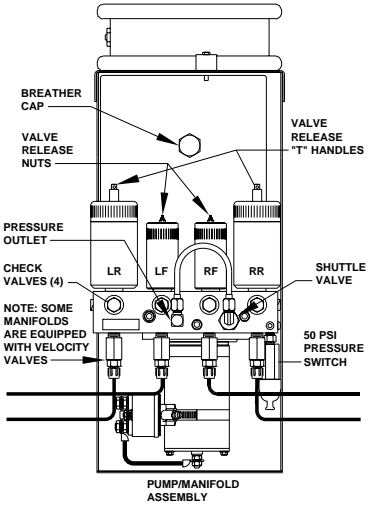
PROBLEM	SOLUTION	DIAGRAM
<p>4g. One or more jacks will not retract while the DOWN ARROW is being pushed.</p> <p>NOTE: Remember when checking for voltage or grounds, all harnesses must be plugged in and a DOWN ARROW must be pushed.</p>	<p>CAUTION: THE VEHICLE MUST BE PROPERLY SUPPORTED SO THE VEHICLE CAN NOT DROP IF PERFORMING A TEST WOULD PLACE A TECHNICIAN UNDER THE VEHICLE.</p> <p>Check the YELLOW and RED LED's for the jacks that will not retract. If both LED's are lit, Manually open the solenoid valve for the jack that will not retract. If the jack does not retract, loosen the hose for the jack(s) that will not retract. This can be done at the jack or hydraulic manifold.</p> <p>IMPORTANT: This may cause the vehicle to drop and cause a loss of fluid.</p> <p>If the jack does not retract replace the jack. If the jack retracts the problem may be the check valve or the velocity valve if so equipped. With the solenoid valves closed and the system off, remove the outer check valve. Replace the cap and retry. If the jack retracts, replace the check valve. If the jack does not retract, replace the velocity valve.</p> <p>If the jack retracts when the solenoid valve is manually opened, check for voltage at the solenoid valve for the jack(s) that will not retract. If voltage is present, replace the solenoid valve. If voltage is not present, there is a connection problem between the control box and manifold.</p> <p>Check the yellow and red LED's for the solenoid valve while pushing DOWN ARROWS. (It is assumed jacks will extend when UP ARROWS are pushed.</p> <p>If the YELLOW LED is lit but not the RED LED, check the fuse for that valve. If the fuse is blown, the solenoid valve or harness is shorted to ground. If the fuse is not blown, replace the control box. If neither LED is lit, replace the touch panel.</p>	<div style="text-align: center;">  <p>REFER TO MP85.212C</p> </div> <div style="text-align: center; margin-top: 20px;">  <p>REFER TO MP65.270C</p> </div>

TROUBLE SHOOTING

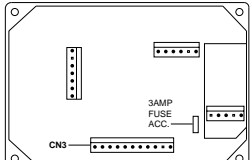
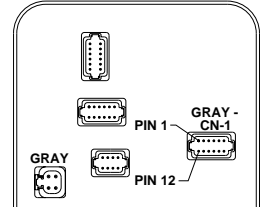
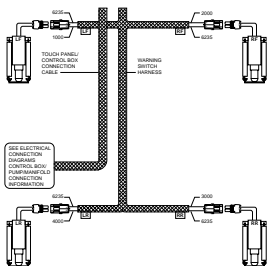
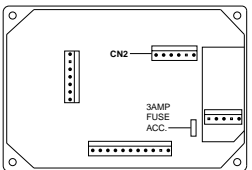
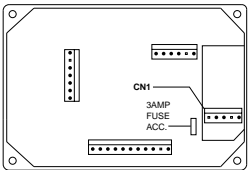
PROBLEM	SOLUTION	DIAGRAM
<p>4h. No jacks will retract when DOWN arrows are pushed. (It is assumed jacks will extend when UP ARROWS are pushed)</p>	<p>Check the YELLOW and RED LED's for the solenoid valves while pushing DOWN arrows. If the LED's are coming on, manually open the solenoid valves. If the jacks do not retract the problem is most likely the shuttle valve. Loosen a hydraulic hose for a jack. The jack should start to retract. If the jack does not retract the problem is the jack. If the jack starts to retract replace the shuttle valve. If the YELLOW and RED LED's are not coming on, while pushing the DOWN arrows, check for a ground on PIN 11 of CN3 at the touch panel and PIN 5 of the 12 pin GRAY connector (CN-1) at the control box while pushing DOWN arrows. If a ground is not present at the touch panel on PIN 11, replace the touch panel. If there is a ground at the touch panel but not at the box on PIN 5, there is a connection or harness problem. If there is a ground at the control box on PIN 5 replace the control box.</p>	<p style="text-align: center;">FOR JACK RETRACTION SOLENOID VALVES REFER TO MP65.270C</p>  <p style="text-align: center;">REFER TO MP85.192C</p>  <p style="text-align: center;">REFER TO MP85.206C</p>
<p>4i. One or more jacks retract slowly or start to retract but will not retract completely.</p>	<p>If a jack will not retract completely, the problem is most likely the jack. If a jack retracts slowly, more than three minutes above 55 degrees outside temperature or more than five minutes at freezing, loosen the hose for that jack. If that does not increase the retract speed, replace the jack. If the jack retracts at a normal speed with the hose loose, the problem would be the velocity valve or solenoid valve.</p>	
<p>4j. A red Warning light on the Touch Panel will not go out. The jacks are fully retracted.</p>	<p>Unplug the warning switch at the jack. If the warning light goes out, replace the warning switch. If replacing the switch does not fix the problem, the cylinder may need to be replaced. Contact HWH Technical Service for assistance.</p> <p>NOTE: Make sure the white wires of the harness and warning switch are in the "A" pins of the Packard connectors. The black wires must be in the "B" pins of the connectors.</p> <p>If the warning light does not go out with the warning switch unplugged, remove the wire for that switch from CN5 at the touch panel. If the light goes out the wire is shorted to ground. If the light does not go out, replace the touch panel.</p>	 <p style="text-align: center;">REFER TO MP85.047C</p>  <p style="text-align: center;">REFER TO MP85.192C</p>
<p>4k. The Master Warning light and/or buzzer will not go out. All Warning lights on the Touch Panel are off.</p>	<p>Disconnect the 7699 wire from the CN1 connector at the touch panel. If the master warning light and buzzer turn off, replace the touch panel. If they remain on, the 7699 wire is shorted to ground.</p>	 <p style="text-align: center;">REFER TO MP85.192C</p>

TROUBLE SHOOTING

Part 5. "STORE" button. The "STORE" button is used to retract all of the jacks at the same time. The "STORE" button will also put the suspension in the TRAVEL MODE if the vehicle is equipped with a pilot air dump system. The LEVEL MODE light must be OFF to use the "STORE" button. The "STORE" button will not work if the LEVEL MODE light is ON. The ignition must be in the "ON" or "ACC" position for the "STORE" button to function. Push the "STORE" button. The STORE light will come on steady. All four jacks will start to retract. If the vehicle is equipped with an air suspension, the suspension should start to return to ride height at this time. As each jack is completely retracted (within 1/4 to 1/2 inch) it's red warning light on the touch panel will go out and it's solenoid valve will turn off. When all of the red warning lights are out, the master warning light and buzzer will be off. The STORE light will remain on until the "OFF" button is pushed or the ignition key is turned.

NOTE: The park brake does not have to be on to use the "STORE" button. The "STORE" light should be on whenever the vehicle is traveling.

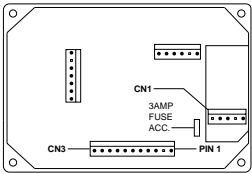
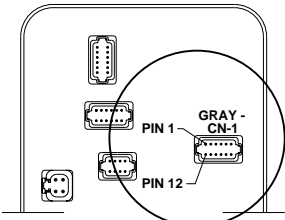
PROBLEM	SOLUTION	DIAGRAM
<p>5a. The STORE light will not come on when the "STORE" button is pushed. light is on.</p>	<p>Push the LEVEL MODE button. If the LEVEL MODE light comes on, push the "OFF" button. Make sure the LEVEL MODE light is OFF. Retry the "STORE" button. If the STORE light does not come ON replace the touch panel.</p> <p>If the LEVEL MODE light does not come ON when pushing the LEVEL MODE button, refer to problem 3a.</p>	
<p>5b. The STORE light will not stay on.</p>	<p>Check voltage between PIN 1 (CN1) and PIN 3 (CN3) at the touch panel. If there is 11+ volts while pushing the "STORE" button and the STORE light does not come ON, replace the touch panel. If the voltage is below 11 volts, there may be a ground, wire, connection or voltage problem.</p>	 <p style="text-align: center;">REFER TO MP85.192C</p>
<p>5c. The STORE light is on, the jacks will not retract.</p>	<p>If a red jack down warning light is not on, it's jack will not retract. Refer to part 4e to diagnose warning light issues.</p> <p>It is assumed at this point the jacks will retract properly using the DOWN arrows on the touch panel. If some jacks will retract, but one or more jacks will not retract, recheck problems 4g and 4h. If the jacks retract properly, replace the touch panel.</p>	 <p style="text-align: center;">REFER TO MP85.206C</p>
<p>5d. The STORE light is on, NO jacks will retract.</p>	<p>Recheck problems 4j and 4k to make sure the jacks retract properly in the manual mode. With the "STORE" light on check pins 4,6,7,8 and 9 of CN3 at the touch panel for ground. If ground is not present on pins 4,6,7,8 or 9, replace the touch panel. If ground is present on these pins, check pin 3, CN1 at the control box for ground. If ground is not present, the problem is the cable or the connections to the touch panel or control box. If ground is present, replace the control box.</p>	
<p>5e. The vehicle will not return to ride height.</p>	<p>Proceed to Part 6.</p>	
<p>5f. The Warning lights on the Touch Panel or the Master Warning light and buzzer will not turn off.</p>	<p>Again it is assumed these items have been checked and are functioning properly. If there is a problem with the touch panel warning lights or master warning light and buzzer at this time, refer to problems 4j and 4k.</p>	

TROUBLE SHOOTING

Part 6. This part is for vehicles with an air suspension.

The air must be dumped from the vehicle air suspension before leveling the vehicle. This is done with a HWH air dump system or a pilot air dump system supplied by the chassis manufacturer.

The HWH air dump system consists of a minimum of one normally closed, +12 volt actuated solenoid valve at the front and one valve at the rear of the vehicle. Some vehicles have one air dump valve for each height control valve. There are 2 wires to each valve. The white wire is constant ground. The black 9300 wire is switched +12 volts to open the valve. The 9300 wire will be hot whenever the LEVEL MODE LIGHT is on. The valve should open and the air should exhaust from the vehicle suspension and air tanks. When the LEVEL MODE light is off, the air dump valves should be closed. Air should not leak through the valves.

The chassis supplied pilot dump system has two positions. One position is the "TRAVEL" mode which allows the height control valves to work. The other position is the "DUMP" mode which will exhaust the air from the suspension air bags only. There are three wires in a four pin UML plug from HWH to operate the pilot valve. The 9300 wire is switched +12 when the LEVEL MODE light is on to put the system in the "TRAVEL" mode. The 9301 wire is switched +12 when the "STORE" light is on to put the system in the "DUMP" mode. The white wire is constant ground. The ignition must be on to have power on the 9301 wire. The 9301 wire will be hot any time the ignition is on if the park brake is off. HWH is only responsible for the three wires from the control box to the four pin UML plug. All other harnesses and equipment are supplied by the chassis or vehicle manufacturer.

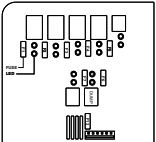
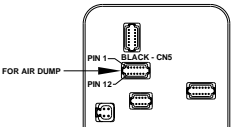
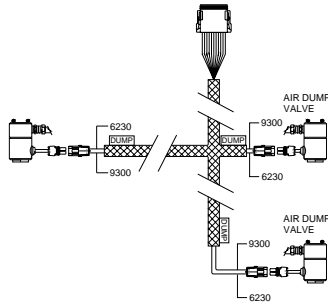
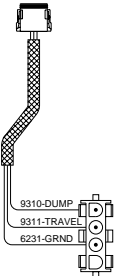
PROBLEM	SOLUTION	DIAGRAM
<p>6a. Air will not dump from the suspension when the LEVEL MODE light is on.</p> <p>NOTE: The HWH and the pilot dump system will be the same basic tests for dumping air.</p>	<p>CAUTION: WHEN TESTING THE AIR DUMP SYSTEM MAKE SURE THE VEHICLE IS SUPPORTED PROPERLY BEFORE GOING UNDER THE VEHICLE. THE VEHICLE WILL DROP SUDDENLY WHEN THE AIR IS EXHAUSTED FROM THE AIR BAGS.</p> <p>Check the YELLOW (11) LED and the RED (12) LED in the control box. If neither LED is lit, check for a ground on PIN 5, CN3 connector at the touch panel and PIN 6, 12 pin GRAY (CN1) connector at the control box. If there is no ground at the panel, replace the touch panel. If there is a ground at the panel but not the control box, the problem is a connection or the 9300 wire in the harness. If there is a ground on PIN 6 at the control box, replace the control box.</p> <p>If the YELLOW (11) LED is lit but not the RED (12) LED, check the fuse. If the fuse is blown there is a short to ground in the 9300 wire that is in the 12 pin BLACK connector (CN5) at the control box or the HWH air valve or pilot valve is shorted.</p> <p>Note: There is one 9300 wire from the control box to control the dump valves, either HWH valves or the chassis pilot dump valve.</p> <p>If the fuse is not blown, replace the control box.</p> <p>If the YELLOW (11) LED and the RED (12) LED are both lit, check for +12 on the 9300 wire and ground on the white wire at the HWH air dump valves or at the four pin UML plug if the vehicle is equipped with a pilot dump system. If power and ground is present, there is a problem with the dump valves or the pilot dump system if so equipped. Contact the vehicle manufacturer for assistance with a pilot dump system.</p> <p>Note: If the vehicle is equipped with HWH dump valves, make sure the exhaust port for the valve is not plugged.</p> <p>If power is not present at the valve or four pin UML plug, the problem is with the 9300 wire, the ground wire or their connections.</p>	<div style="text-align: center;">  <p>REFER TO MP85.212C</p> </div> <div style="text-align: center;">  <p>REFER TO MP85.207C</p> </div> <div style="text-align: center;">  <p>REFER TO MP85.2195 (HWH AIR DUMP VALVES)</p> </div> <div style="text-align: center;">  <p>REFER TO MP85.2215 (PILOT DUMP SYSTEM)</p> </div>

TROUBLE SHOOTING

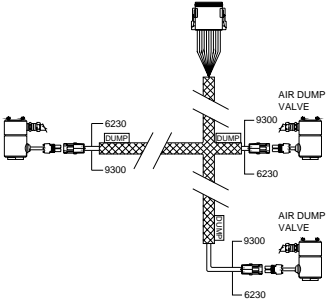
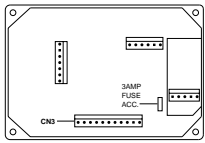
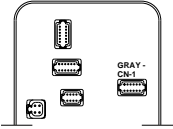
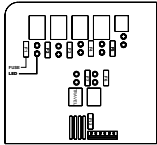
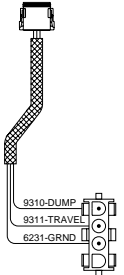
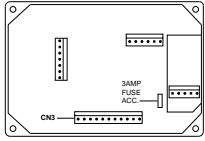
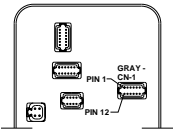
PROBLEM	SOLUTION	DIAGRAM
<p>For vehicles that are equipped with HWH air dump system.</p> <p>6b. The vehicle will not return to ride height.</p>	<p>Make sure there is at least 100 psi of air in the vehicle air tanks. The ignition must be on. Make sure the touch panel LEVEL MODE light is OFF. If air is not exhausting from the dump valves, the problem is in the vehicle suspension, most likely a height control valve. If air is exhausting from the dump valve(s) unplug the dump valve(s). If the air continues to exhaust from the valve(s), replace the valve(s).</p> <p>If the air stops exhausting from the dump valve(s) when they are unplugged, check for a ground on PIN 5 of CN3 at the touch panel with the CN3 connector unplugged. If a ground is present, replace the touch panel. If a ground is not present, unplug the GRAY 12 pin connector (CN1) at the control box. Check PIN 6 in the harness plug for a ground. If a ground is present, the 9300 wire in the touch panel harness is shorted to ground. If there is no ground on PIN 6, replace the control box.</p>	 <p style="text-align: center;">REFER TO MP85.2195</p>  <p style="text-align: center;">REFER TO MP85.192C</p>  <p style="text-align: center;">REFER TO MP85.207C</p>
<p>For vehicles equipped with a pilot air dump system.</p> <p>6c. The vehicle will not return to ride height.</p>	<p>Make sure there is at least 100 psi of air in the vehicle air tanks. The ignition must be on. Make sure the STORE light is ON. Check the YELLOW (13) LED and the RED (14) LED for travel. Both LED's should be lit. If both LED's are lit, check for +12 volts between the white ground wire and the 9301 wire in the HWH 4 pin UML plug. If power is not present, the problem is either the white ground wire, the 9301 wire or their connections. If power is present, the problem is with the chassis equipment or harness. Contact the vehicle manufacturer for assistance.</p> <p>If the YELLOW (13) LED is lit but not the RED (14) LED, check the F7 fuse for TRAVEL. If the fuse is OK, replace the control box. If the fuse is blown, the 9301 wire is shorted to ground or there is a short in the vehicle pilot dump equipment. Unplug the HWH 4 pin UML plug. Replace the fuse and retry. If the fuse blows again the 9301 wire is the problem. If the fuse does not blow, the vehicle equipment is the problem.</p> <p>If neither LED is lit, check for a ground on PIN 4, CN3 at the touch panel. If there is no ground, replace the touch panel. If there is a ground on PIN 4, check for a ground on PIN 3 in the 12 pin GRAY connector (CN1) at the control box. If there is no ground, the problem is the 9301 wire or it's connections at the touch panel or control box. If there is a ground on PIN 3, replace the control box.</p>	 <p style="text-align: center;">REFER TO MP85.212C</p>  <p style="text-align: center;">REFER TO MP85.2215</p>  <p style="text-align: center;">REFER TO MP85.192C</p>  <p style="text-align: center;">REFER TO MP85.207C</p>

TROUBLE SHOOTING

Part 7. Sensing Unit Test. The sensing unit is located in the control box. There are four yellow LED's on the sensing unit. These LED's will match the yellow Level Sensing lights on the touch panel. With the vehicle level all of the lights on the sensing unit and the touch panel should be out. If one or two lights are on, adjust the sensing unit according to the SENSING UNIT ADJUSTMENT page in the diagram section. It is important to note that very small movements of the adjusting nut or screw should be all that is needed to change the yellow LED's on the sensing unit. Use the jacks to raise one side or end of the vehicle at a time to make sure each yellow Level light will come on and go back out.

The sensing unit LED's can be checked with just the ignition on. The Level Sensing lights on the touch panel can only be checked if the LEVEL MODE light is on.

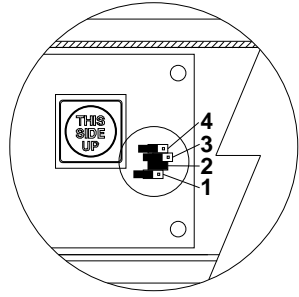
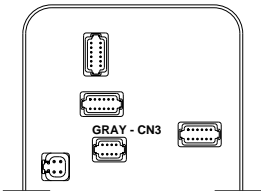
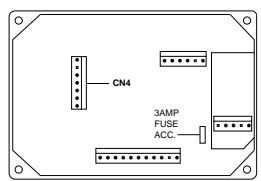
PROBLEM	SOLUTION	DIAGRAM
<p>7a. The Sensing Unit cannot be adjusted to turn off the yellow LED's.</p>	<p>Check the sensing unit adjustment bracket for cracks, breaks or deformities. Make sure the adjustment screw is not stripped out. If the components of the adjustment bracket are OK, replace the sensing unit.</p>	<p style="text-align: center;">REFER TO MP85.6148 (Sensing Unit Adjustment)</p> <p style="text-align: center;">MP85.451C MP85.451D (Jumper Placement)</p>  <p style="text-align: center;">REFER TO MP85.451C</p>
<p>7b. The lights on the touch panel do not match the lights on the sensing unit.</p>	<p>Due to the fact that the control box/ power unit assembly may be mounted in any one of four directions, the sensing unit may be programmed to match the mounting direction. Aftermarket and replacement control boxes and sensing units are equipped with programming jumpers. If the unit is equipped with these jumpers, check the programming instructions in the diagram section to make sure the jumpers are in the correct position. If the jumpers are correct or the sensing unit is not equipped with the jumpers, check CN3 and CN4 of the control box and CN4 of the touch panel to make sure that the wires are in the proper positions.</p> <p>If the sensing unit is not equipped with the programming jumpers, get the AP part number off the control box and contact HWH to make sure the proper control box is being used.</p> <p>If the wiring, the jumper placement, and the control box is OK, replace the sensing unit.</p>	 <p style="text-align: center;">REFER TO MP85.206C</p>  <p style="text-align: center;">REFER TO MP85.192C</p>
<p>7c. Level Sensing lights cannot be made to come on or go out.</p>	<p>Refer to problem 3c.</p>	

SENSING UNIT MAINTENANCE/SERVICE

SENSING UNIT ACCURACY TOLERANCE

The sensing unit has an accuracy tolerance of ± 5.4 inches front to rear and ± 1 inch side to side on a 36 foot vehicle. Typical leveling results will be better.

SENSING UNIT ADJUSTMENT

To adjust the sensing unit, first the vehicle must be level. Either position the vehicle on a level surface or use the leveling system to manually level the vehicle. It is recommended to use the vehicle trim line to determine level. An alternative would be to use a small bubble level. If using a bubble level, the level should be placed on a flat surface close to the mounting location of the control box/sensing unit.

With the vehicle level, if there are no yellow light lit on the Touch Panel, the sensing unit is properly adjusted. If there are yellow LEVEL lights lit on the Touch Panel, manual adjustments to the Sensing Unit are needed. A Phillips screw driver or sockets w/driver or box end wrenches of 7/8, 3/4, 1/2, 5/16 or 1/4 sizes will be needed.

The Sensing Unit is mounted inside the Control Box. The Control Box is mounted to the power unit/valve assembly.

There are four LED's on the Sensing Unit, A,B,C and D. Refer to the drawing below. The Sensing Unit is adjusted by turning the adjustment nut to turn out LED's B and D. The adjustment screw will turn out LED's A and C. If the adjustment nut has to be turned more than 1/2 flat or the adjustment screw has to be turned more than 3/4 turn to turn the LED out, there may be a problem with the Sensing Unit or the mounting of the Control Box. If two LED's are on, it is best to make the B-D adjustments first, then hold the adjustment nut from moving while making the A-C adjustment.

NOTE: If opposing LED's are lit, there is a problem with the Sensing Unit.

If LED (A) is lit: Turn the adjustment screw COUNTER CLOCKWISE until the LED is off.

If LED (C) is lit: Turn the adjustment screw CLOCKWISE until the LED is off.

If LED (B) is lit: Turn the adjustment nut COUNTER CLOCKWISE until the LED is off.

If LED (D) is lit: Turn the adjustment nut CLOCKWISE until the LED is off.

IMPORTANT: When all 4 LED's are off, move the vehicle to an unlevel position so one or two yellow lights are on. Level the vehicle according to the yellow LEVEL lights. Recheck the level. If more adjustment is needed, DO NOT try to adjust the sensing unit until the yellow level lights go out, instead just "tweak" the sensing unit, ignoring the LED's on the sensing unit.

Example: After the initial adjustment and releveling the vehicle, the front is still low. This means the front yellow level light is turning off too soon. Determine which sensing unit light is the front light, A-B-C or D. Move the adjustment for that light very, very, slightly in the OPPOSITE direction that is given in the above instructions for LED's A, B, C, and D. This will allow the front yellow light to stay on slightly longer to bring the front up more. Again, unlevel the vehicle then relevel the vehicle using the yellow level lights on the touch panel. Recheck with a level. Repeat the "tweaking" process until the system levels the vehicle properly.

TOP VIEW - SENSING UNIT

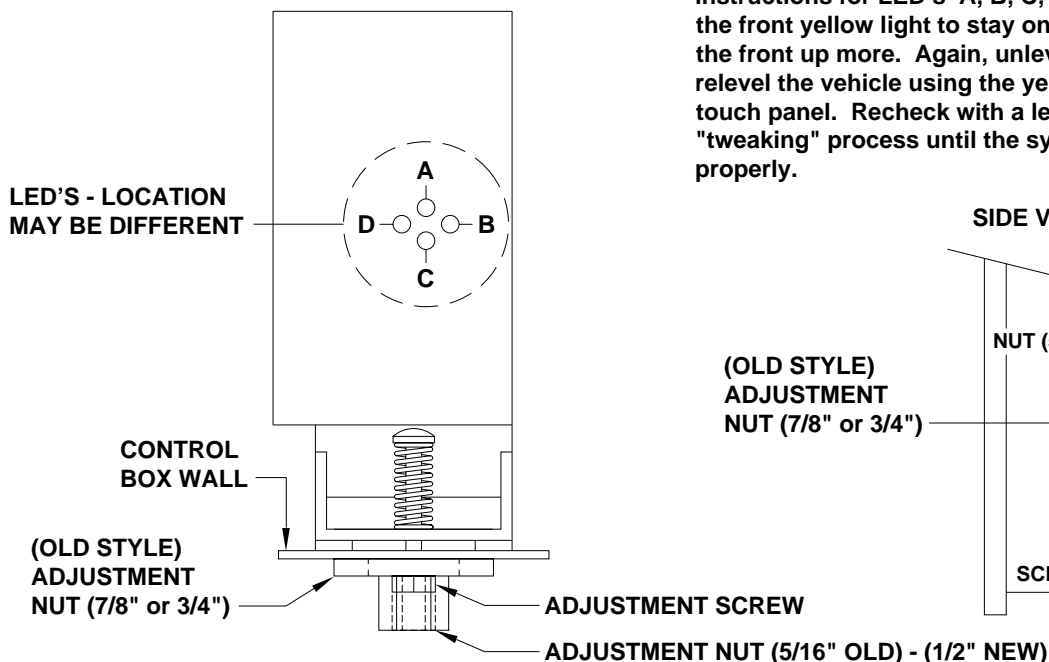

SIDE VIEW - CONTROL BOX

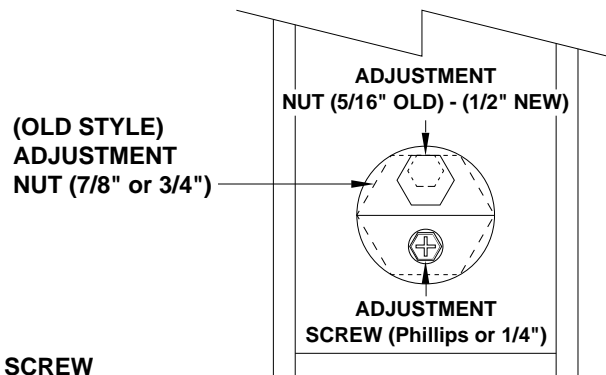



**READ
INSTRUCTIONS
THOROUGHLY
BEFORE
PROCEEDING**

INSTRUCTION SHEET - JUMPER PLACEMENT FOR 325 AND 625 AFTER MARKET INSTALLATIONS OR ELECTRONIC SENSING UNIT REPLACEMENT

IMPORTANT: 325 AND 625 ELECTRONIC SENSING UNITS USED IN AFTER MARKET INSTALLATIONS OR REPLACEMENT SITUATIONS ARE PROGRAMMABLE. DURING INSTALLATION OF A SYSTEM OR REPLACEMENT OF AN ELECTRONIC SENSING UNIT DO NOT ASSUME THAT THE SENSING UNIT JUMPERS ARE PRE-SET. THE MOUNTED ORIENTATION OF THE CONTROL BOX ASSEMBLY AND THE SUSPENSION TYPE MUST BE ESTABLISHED IN ORDER TO SET THE JUMPERS AS NEEDED TO PROGRAM THE SENSING UNIT TO THE COACH.

JP1 AND JP2 - CONTROL BOX ORIENTATION (Page 1 of 2)

MOVE JUMPERS JP1 AND JP2 ACCORDING TO THE ORIENTATION OF THE CONTROL BOX. USE THE DRAWINGS PROVIDED TO DETERMINE WHICH APPLICATION IS FOR THE ORIENTATION OF YOUR CONTROL BOX.

FOR SHIPPING PURPOSES THE (4) JUMPERS ARE SLID ONTO ONE SIDE OF JP1 THROUGH JP4. MOVE ONLY THE JUMPERS NEEDED TO DETERMINE ORIENTATION AND SUSPENSION. LEAVING THE REMAINING JUMPERS AS THEY ARE SHIPPED WILL NOT CAUSE PROBLEMS.

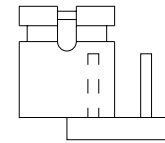
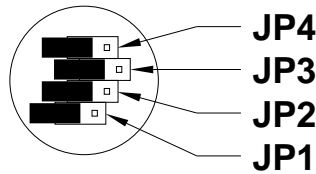

SHIPPED POSITION

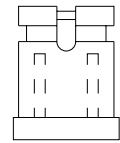

MOVED POSITION

THE FOLLOWING DRAWINGS SHOW THE SENSING UNIT, INSIDE THE CONTROL BOX, AS VIEWED WHEN LOOKING DOWN FROM THE TOP OF THE CONTROL BOX. REMOVE THE RUBBER RING AND PLASTIC COVER ONLY IF NEEDED. THE RING AND COVER MUST BE REINSTALLED.

FRONT OF VEHICLE

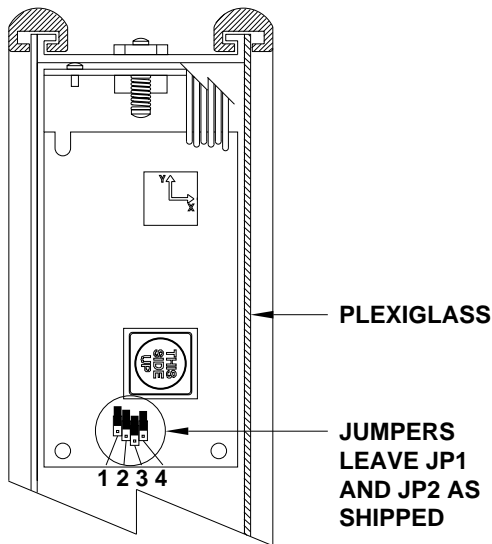

FRONT OF VEHICLE

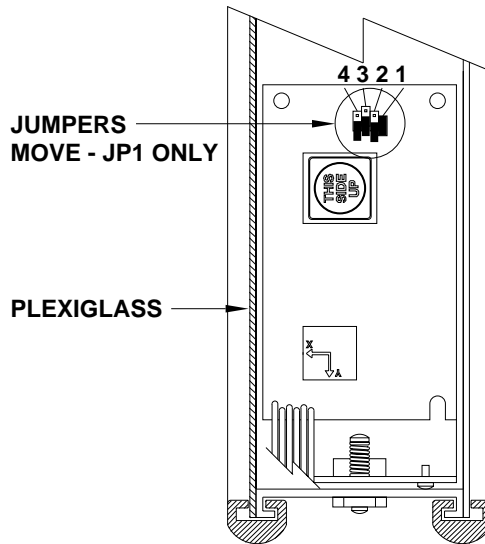

FRONT OF VEHICLE

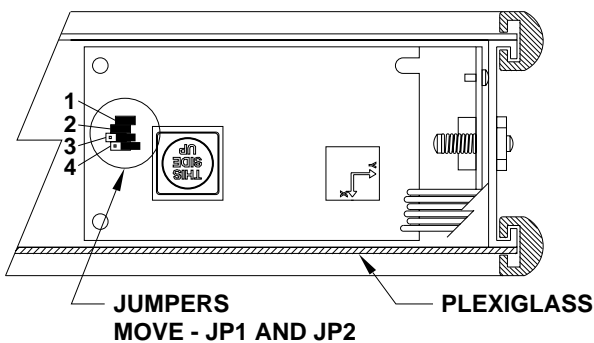

FRONT OF VEHICLE

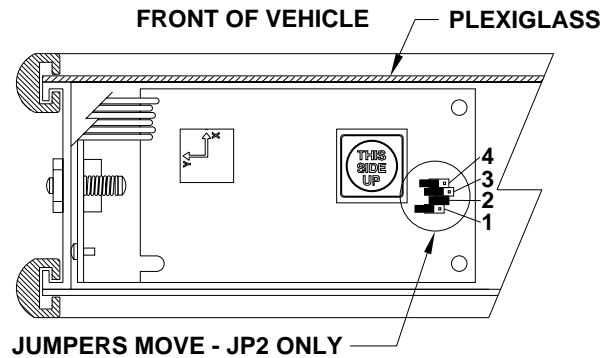

NOTE: AFTER MOVING THE JUMPERS, REMOVE AND REAPPLY +12 POWER FOR THE CONTROL BOX. THIS WILL "RE-BOOT" THE SENSING UNIT.

**MP45.272M
17SEP07**



**READ
INSTRUCTIONS
THOROUGHLY
BEFORE
PROCEEDING**

INSTRUCTION SHEET - JUMPER PLACEMENT FOR 325 AND 625 AFTER MARKET INSTALLATIONS OR ELECTRONIC SENSING UNIT REPLACEMENT

IMPORTANT: 325 AND 625 ELECTRONIC SENSING UNITS USED IN AFTER MARKET INSTALLATIONS OR REPLACEMENT SITUATIONS ARE PROGRAMMABLE. DURING INSTALLATION OF A SYSTEM OR REPLACEMENT OF AN ELECTRONIC SENSING UNIT DO NOT ASSUME THAT THE SENSING UNIT JUMPERS ARE PRE-SET. THE MOUNTED ORIENTATION OF THE CONTROL BOX ASSEMBLY AND THE SUSPENSION TYPE MUST BE ESTABLISHED IN ORDER TO SET THE JUMPERS AS NEEDED TO PROGRAM THE SENSING UNIT TO THE COACH.

JP3 AND JP4 - CONTROL SUSPENSION TYPE (Page 2 of 2)

MOVE JUMPERS JP3 AND JP4 ACCORDING TO THE TYPE OF SUSPENSION ON THE VEHICLE.

JUMPERS JP3 AND JP4 DETERMINE SUSPENSION TYPE.

SPRING - LEAVE JUMPERS JP3 AND JP4 AS SHIPPED.
NEITHER JUMPER NEEDS TO BE MOVED.

AIR - LEAVE JUMPER JP4 AS SHIPPED, MOVE JP3 ONLY.
DIAGRAM BELOW SHOWS AIR SUSPENSION SETUP.

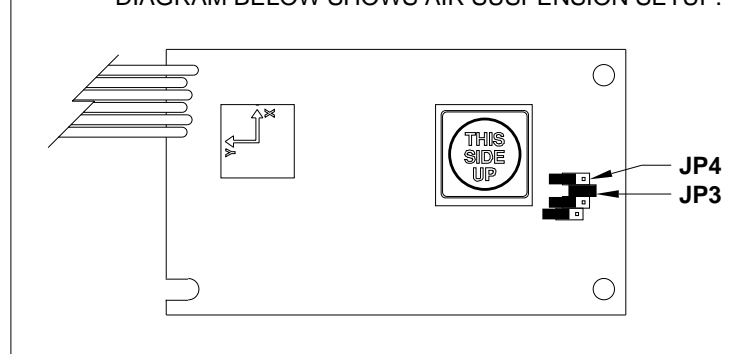

HYDRAULIC LINE CONNECTION DIAGRAM

305/325 SERIES LEVELING SYSTEM

(WITH 4 STRAIGHT-ACTING JACKS)

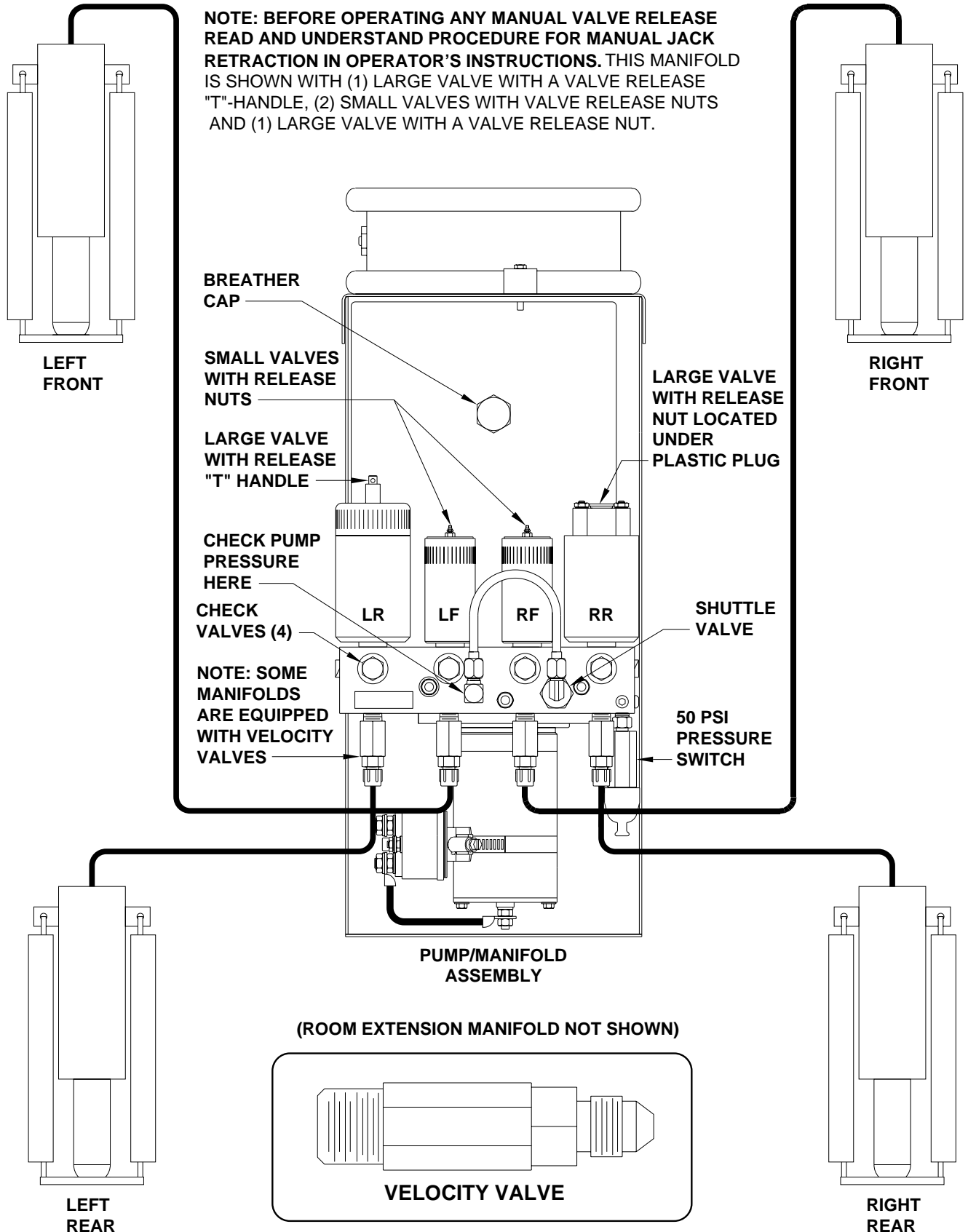

HYDRAULIC SCHEMATIC
305/310/325 SERIES LEVELING SYSTEM
WITH STRAIGHT-ACTING JACKS

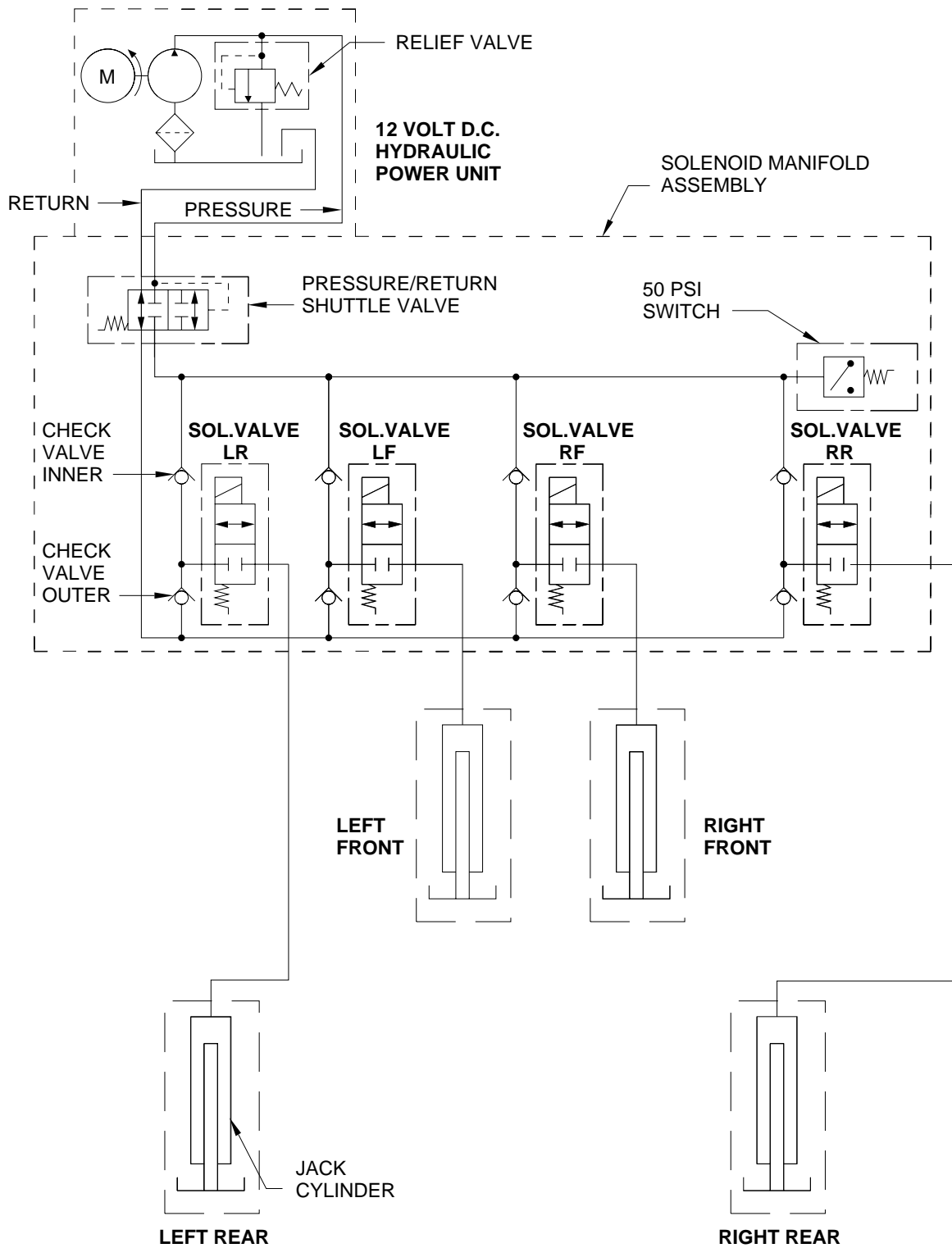

ELECTRICAL CONNECTION DIAGRAM

305/325 SERIES LEVELING SYSTEM

TOUCH PANEL CONNECTIONS

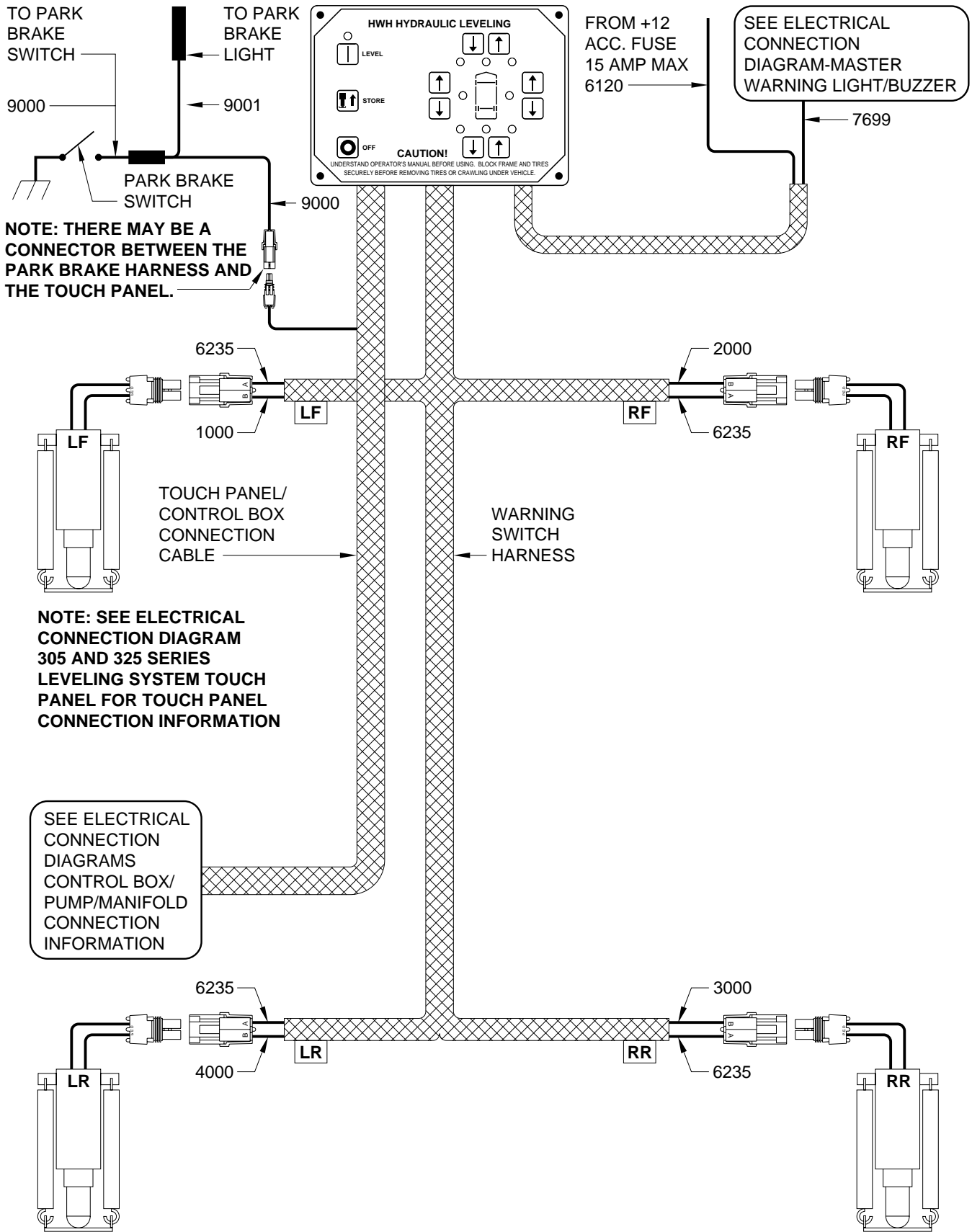

ELECTRICAL CONNECTION DIAGRAM

305 AND 325 SERIES LEVELING SYSTEM TOUCH PANEL

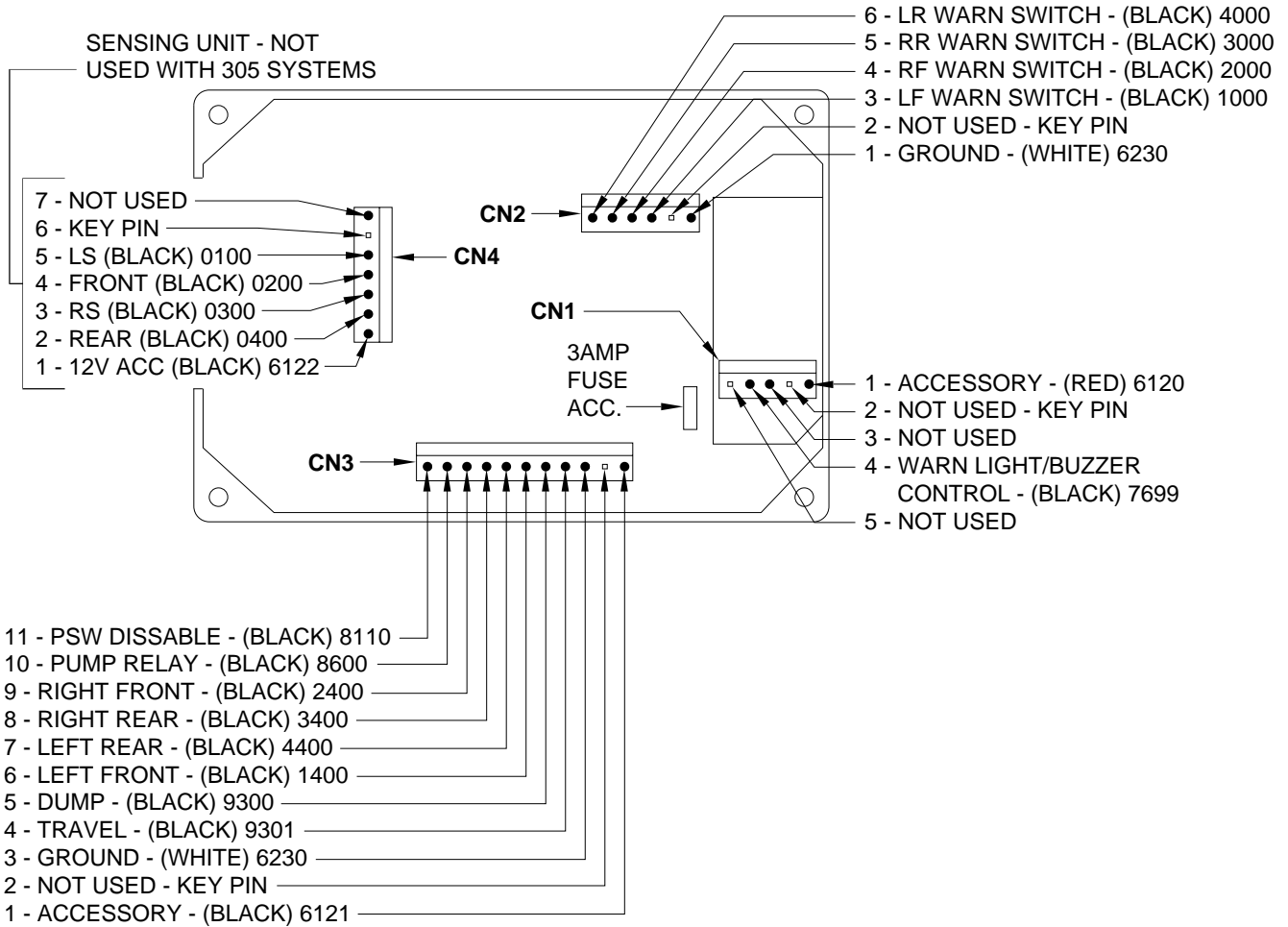
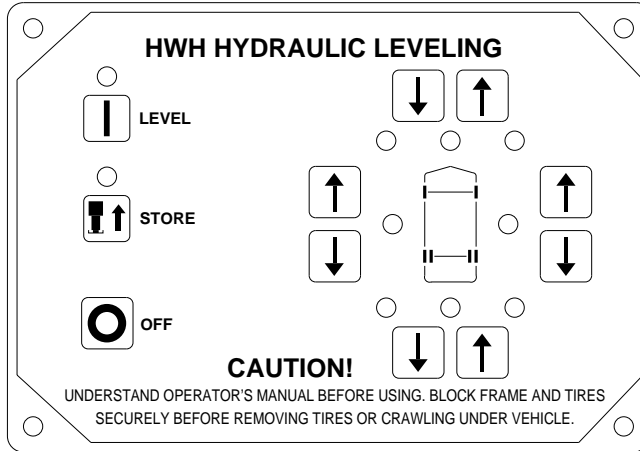

NOTE: FOR WIRE FUNCTION INFORMATION SEE ELECTRICAL CONNECTION DIAGRAM - TOUCH PANEL WIRE LEGEND.

ELECTRICAL CONNECTION DIAGRAM

TOUCH PANEL WIRE LEGEND

PIN #	WIRE COLOR	WIRE NUMBER	WIRE DESCRIPTION AND FUNCTION
CN1			5 PIN CONNECTOR
1	RED	6120	+12V ACC. POWER
2			KEY PIN - NO CONNECTION
3			NO CONNECTION
4	BLACK	7699	SWITCHED GROUND FOR WARNING LIGHT/BUZZER CONTROL
5			NO CONNECTION
CN2			6 PIN CONNECTOR
1	WHITE	6235	GROUND FOR JACK WARNING SWITCHES
2			KEY PIN - NO CONNECTION
3	BLACK	1000	SWITCHED GROUND FOR LF WARNING LIGHT
4	BLACK	2000	SWITCHED GROUND FOR RF WARNING LIGHT
5	BLACK	3000	SWITCHED GROUND FOR RR WARNING LIGHT
6	BLACK	4000	SWITCHED GROUND FOR LR WARNING LIGHT
CN3			11 PIN CONNECTOR
1	BLACK	6121	+12V ACC. POWER FOR CONTROL BOX
2			KEY PIN - NO CONNECTION
3	WHITE	6230	CHASSIS GROUND FROM CONTROL BOX
4	BLACK	9301	SWITCHED GROUND TO CONTROL BOX FOR TRAVEL
5	BLACK	9300	SWITCHED GROUND TO CONTROL BOX FOR DUMP
6	BLACK	1400	SWITCHED GROUND TO CONTROL BOX FOR LF SOLENOID VALVE
7	BLACK	4400	SWITCHED GROUND TO CONTROL BOX FOR LR SOLENOID VALVE
8	BLACK	3400	SWITCHED GROUND TO CONTROL BOX FOR RR SOLENOID VALVE
9	BLACK	2400	SWITCHED GROUND TO CONTROL BOX FOR RF SOLENOID VALVE
10	BLACK	8600	SWITCHED GROUND TO CONTROL BOX FOR PUMP RELAY
11	BLACK	8110	SWITCHED GROUND TO CONTROL BOX FOR PRESSURE SW. OVERRIDE
CN4			7 PIN CONNECTOR
1	RED	6122	+12V ACC. POWER FOR LEVEL SENSING UNIT
2	ORANGE	0400	SWITCHED GROUND FOR REAR LEVEL LIGHT
3	GREEN	0300	SWITCHED GROUND FOR RIGHT SIDE LEVEL LIGHT
4	BLACK	0200	SWITCHED GROUND FOR FRONT LEVEL LIGHT
5	YELLOW	0100	SWITCHED GROUND FOR LEFT SIDE LEVEL LIGHT
6			KEY PIN - NO CONNECTION
7	WHITE		GROUND FOR LEVEL SENSING UNIT (MAY NOT BE USED)

ELECTRICAL CONNECTION DIAGRAM

325 SERIES LEVELING SYSTEM

CONTROL BOX CONNECTION INFORMATION

PAGE 1 OF 2

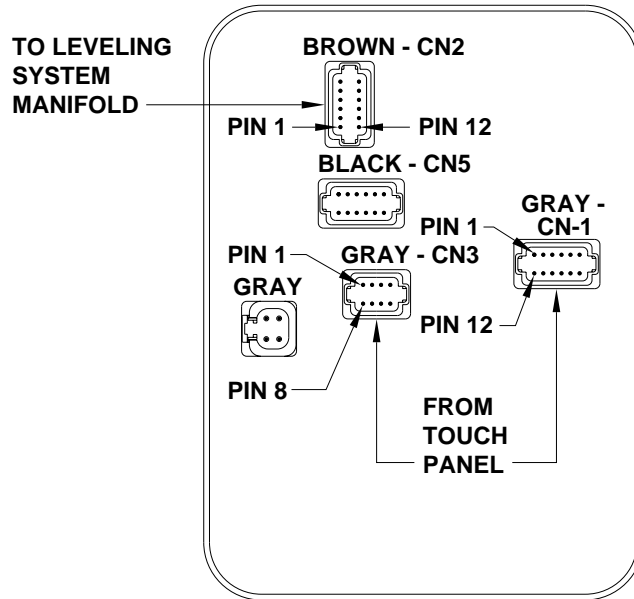

PIN #	WIRE COLOR	WIRE NUMBER	WIRE DESCRIPTION AND FUNCTION
CN1			12 PIN GRAY CONNECTOR
1	BLACK	1400	SWITCHED GROUND FROM TOUCH PANEL LEFT FRONT CONTROL
2	BLACK	3400	SWITCHED GROUND FROM TOUCH PANEL RIGHT REAR CONTROL
3	BLACK	9301	SWITCHED GROUND FROM TOUCH PANEL FOR TRAVEL
4	WHITE	6230	GROUND FOR TOUCH PANEL
5	BLACK	8110	SWITCHED GROUND FROM TOUCH PANEL FOR PRESS SW OVERRIDE
6	BLACK	9300	SWITCHED GROUND FROM TOUCH PANEL FOR DUMP
7	BLACK	9000	SWITCHED GROUND FROM PARK BRAKE SWITCH
8			NO CONNECTION
9	BLACK	2400	SWITCHED GROUND FROM TOUCH PANEL RIGHT FRONT CONTROL
10	BLACK	4400	SWITCHED GROUND FROM TOUCH PANEL LEFT REAR CONTROL
11	BLACK	8600	SWITCHED GROUND FROM TOUCH PANEL PUMP RELAY CONTROL
12	BLACK	6121	+12V ACC. POWER FROM TOUCH PANEL
CN2			12 PIN BROWN CONNECTOR
1			NO CONNECTION
2	WHITE	6243	GROUND FOR LEFT FRONT SOLENOID VALVE
3	WHITE	6242	GROUND FOR RIGHT FRONT SOLENOID VALVE
4	WHITE	6241	GROUND FOR RIGHT REAR SOLENOID VALVE
5	WHITE	6240	GROUND FOR LEFT REAR SOLENOID VALVE
6	BLACK	8100	SWITCHED GROUND FROM MANIFOLD PRESSURE SWITCH
7	BLACK	9000	GROUND FROM PARK BRAKE SWITCH TO PUMP RELAY
8	BLACK	4400	SWITCHED +12 FOR LEFT REAR SOLENOID VALVE
9	BLACK	2400	SWITCHED +12 FOR RIGHT FRONT SOLENOID VALVE
10	BLACK	1400	SWITCHED +12 FOR LEFT FRONT SOLENOID VALVE
11	BLACK	3400	SWITCHED +12 FOR RIGHT REAR SOLENOID VALVE
12	BLACK	8600	SWITCHED +12 FOR PUMP RELAY
CN3			8 PIN GRAY CONNECTOR - SENSING UNIT
1	BLACK	0400	REAR - SWITCHED GROUND
2	BLACK	0300	RIGHT SIDE - SWITCHED GROUND
3	BLACK	0200	FRONT - SWITCHED GROUND
4	BLACK	0100	LEFT SIDE - SWITCHED GROUND
5 THRU 7			NO CONNECTION
8	BLACK	6122	ACCESSORY

**ELECTRICAL CONNECTION DIAGRAM
325 SERIES LEVELING SYSTEM
CONTROL BOX CONNECTION INFORMATION
PAGE 2 OF 2**

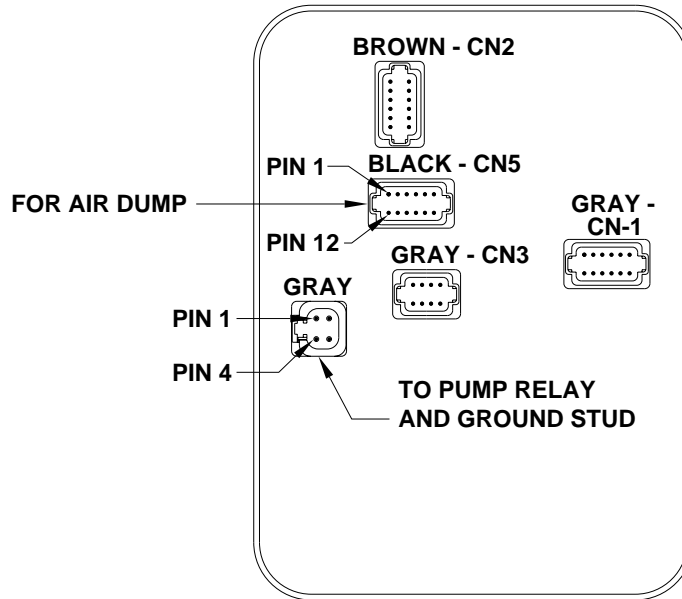

PIN #	WIRE COLOR	WIRE NUMBER	WIRE DESCRIPTION AND FUNCTION
GRAY CONNECTOR			4 PIN GRAY CONNECTOR
1	RED	6100	+12V BATTERY POWER FROM PUMP RELAY
2	RED	6100	+12V BATTERY POWER FROM PUMP RELAY
3	WHITE	6230	GROUND FROM HWH GROUND STUD
4	WHITE	6230	GROUND FROM HWH GROUND STUD
CN5			12 PIN BLACK CONNECTOR
1 THRU 5			NO CONNECTION
6	WHITE	6230	GROUND FOR AIR DUMP VALVES
7	BLACK	9300	SWITCHED +12 TO AIR DUMP VALVES
8 THRU 12			NO CONNECTION

ELECTRICAL CONNECTION DIAGRAM

LED - FUSE LOCATION AND DESCRIPTION

305/325 CONTROL BOX

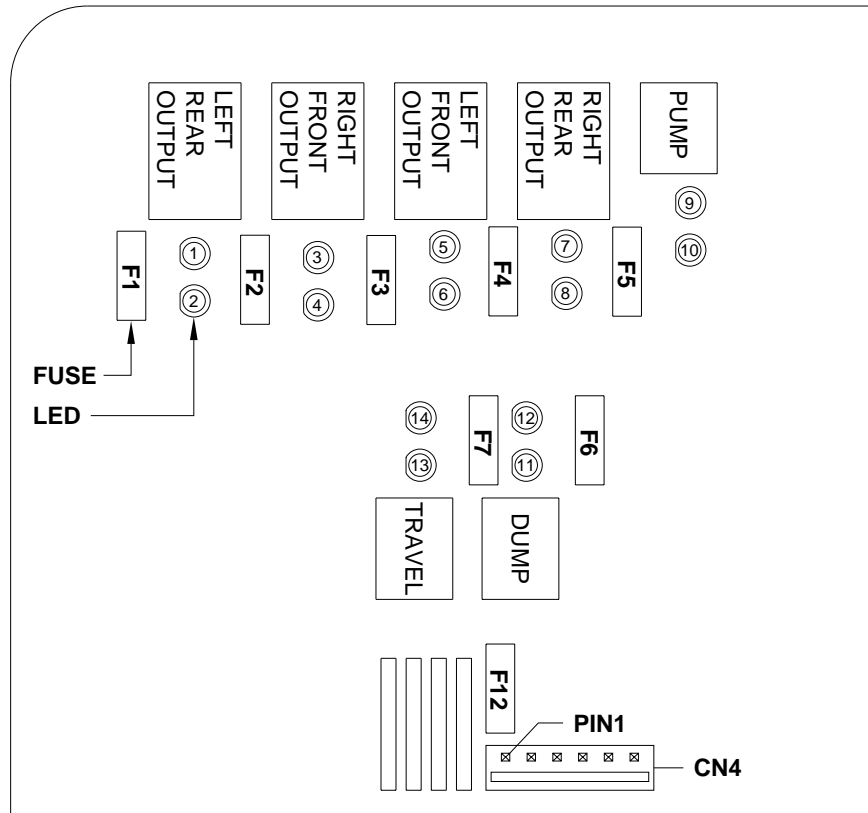

LED	RELAY DESCRIPTION	FUSE
1-YELLOW	LEFT REAR	F1-15 AMP
2-RED	LEFT REAR	F1-15 AMP
3-YELLOW	RIGHT FRONT	F2-15 AMP
4-RED	RIGHT FRONT	F2-15 AMP
5-YELLOW	LEFT FRONT	F3-15 AMP
6-RED	LEFT FRONT	F3-15 AMP
7-YELLOW	RIGHT REAR	F4-15 AMP
8-RED	RIGHT REAR	F4-15 AMP
9-YELLOW	PUMP	F5-5 AMP
10-RED	PUMP	F5-5 AMP
11-YELLOW	DUMP	F6-5 AMP
12-RED	DUMP	F6-5 AMP
13-YELLOW	TRAVEL	F7-5 AMP
14-RED	TRAVEL PARK BRAKE	F7-5 AMP
		F12-3 AMP

NOTE: DUMP AND TRAVEL FUNCTIONS MAY NOT BE PRESENT.

NOTE: FOR DETAILED INPUT / OUTPUT INFORMATION ABOUT PIN CONNECTIONS SEE ELECTRICAL CONNECTION DIAGRAM - CONTROL BOX CONNECTION INFORMATION.

NOTE: A LIT YELLOW LED INDICATES THERE IS A GROUND SIGNAL TO TURN THE CORRESPONDING RELAY ON.

A LIT RED LED INDICATES THERE IS VOLTAGE ON IT'S CORRESPONDING OUTPUT PIN.

IF A YELLOW LED IS LIT AND THE CORRESPONDING RED LED IS OFF, EITHER IT'S FUSE IS BLOWN OR THE RELAY IS BAD.

IF THE YELLOW LED'S ARE WORKING BUT NO RED LED IS COMING ON THERE MAY BE PROBLEM WITH INPUT VOLTAGE IN THE 4-PIN CONNECTOR.

IF A YELLOW LED IS NOT LIT, THERE IS A PROBLEM WITH THE CONTROL BOX, TOUCH PANEL OR CONNECTION CABLE

CN4 - SENSING UNIT CONNECTIONS
 PIN1 - RED - (+12 ACC) FOR SENSING UNIT
 PIN2 - RED - GROUND FOR REAR YELLOW LEVEL LIGHT
 PIN3 - GREEN - GROUND FOR RIGHT SIDE YELLOW LEVEL LIGHT
 PIN4 - BLACK - GROUND FOR FRONT YELLOW LEVEL LIGHT
 PIN5 - YELLOW - GROUND FOR LEFT SIDE YELLOW LEVEL LIGHT
 PIN6 - WHITE - GROUND FOR SENSING UNIT

ELECTRICAL CONNECTION DIAGRAM

305/325 SERIES POWER UNIT

LEVELING MANIFOLD - PUMP RELAY - OPTIONAL HWH AIR DUMP

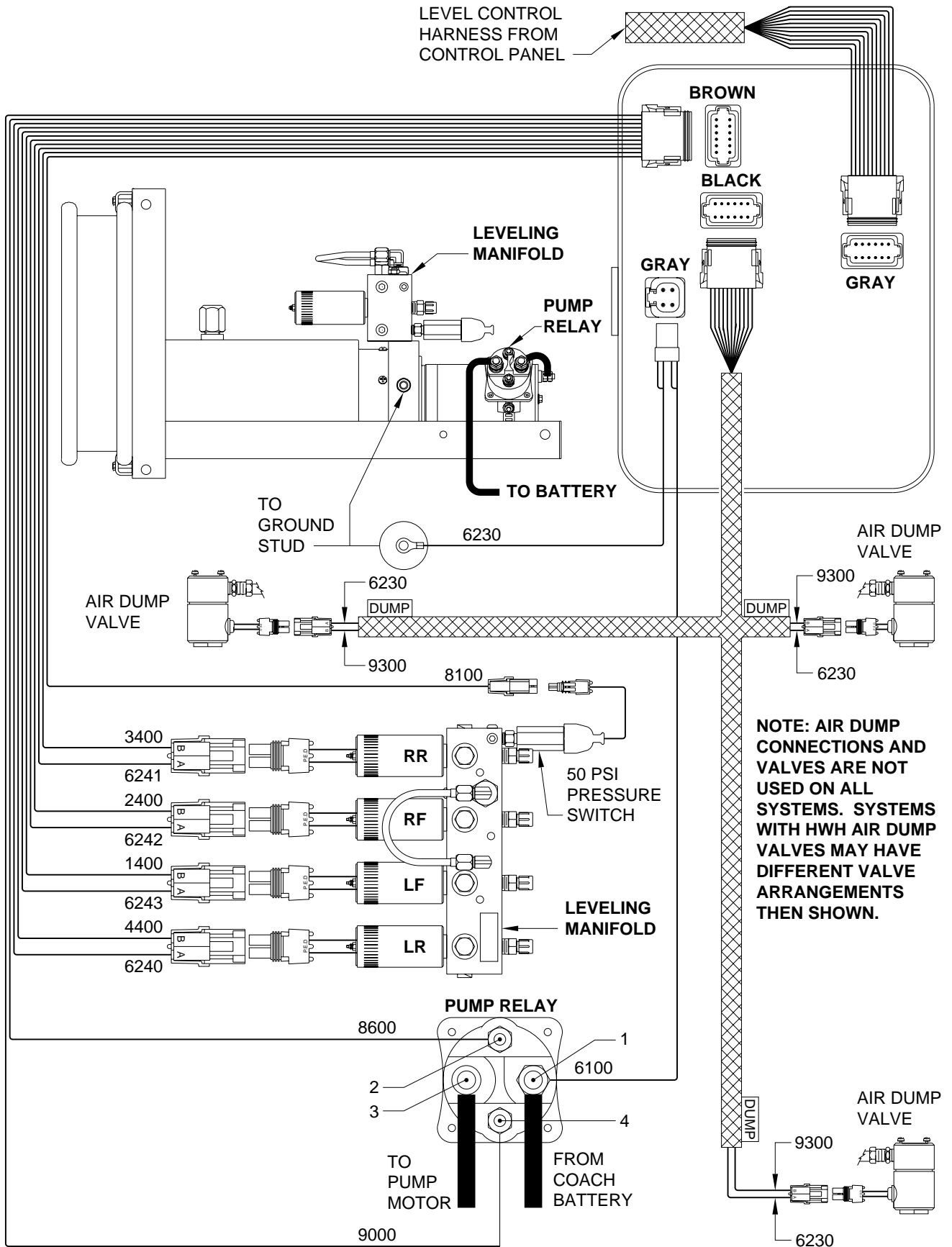

ELECTRICAL CONNECTION DIAGRAM

305/325 SERIES POWER UNIT

LEVELING MANIFOLD - PUMP RELAY - PILOT AIR DUMP

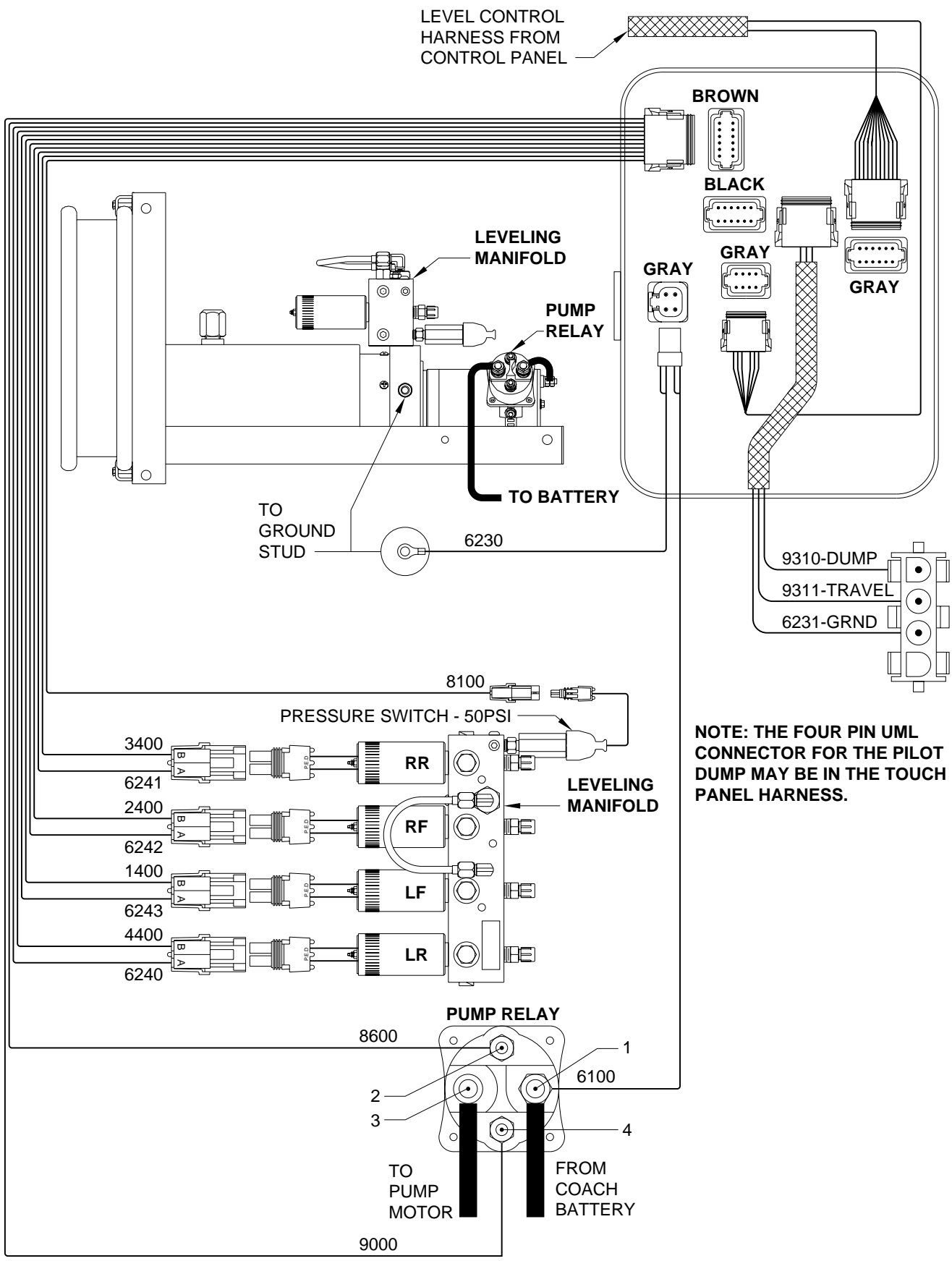

NOTE: THE FOUR PIN UML CONNECTOR FOR THE PILOT DUMP MAY BE IN THE TOUCH PANEL HARNESS.

MASTER LIGHT/BUZZER CONNECTION DIAGRAM

MANUAL LEVELING SYSTEMS

305/310/325 SERIES LEVELING SYSTEM

A MASTER WARNING INDICATOR SHOULD ALWAYS BE USED. WHEN THE LEVELING SYSTEM HAS STRAIGHT-ACTING JACKS A WARNING BUZZER MUST BE USED.

NOTE: BY SUPPLYING IGNITION POWER TO THE WARNING BUZZER AND LIGHT, AND "ACC" POWER TO THE CONTROL BOX, THE SYSTEM MAY BE OPERATED IN ACCESSORY WITHOUT THE BUZZER SOUNDING. THE NEGATIVE SIGNAL FOR THE WARNING INDICATORS MUST ALWAYS COME FROM THE TOUCH PANEL.

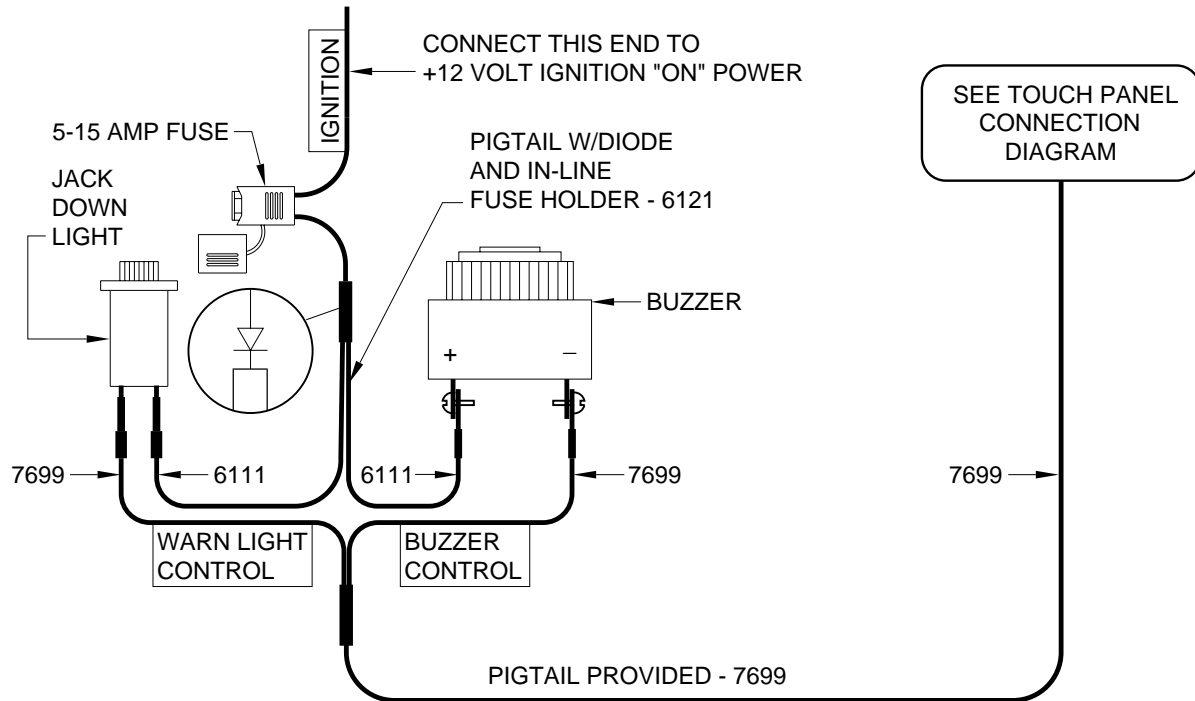



**READ
INSTRUCTIONS
THOROUGHLY
BEFORE
PROCEEDING**

ELECTRICAL CONNECTION DIAGRAM ELECTRONIC SENSING UNIT JUMPER PLACEMENT

IMPORTANT: 325 AND 625 ELECTRONIC SENSING UNITS USED IN AFTER MARKET INSTALLATIONS OR REPLACEMENT SITUATIONS ARE PROGRAMMABLE. DURING INSTALLATION OF A SYSTEM OR REPLACEMENT OF AN ELECTRONIC SENSING UNIT DO NOT ASSUME THAT THE SENSING UNIT JUMPERS ARE PRE-SET. THE MOUNTED ORIENTATION OF THE CONTROL BOX ASSEMBLY AND THE SUSPENSION TYPE MUST BE ESTABLISHED IN ORDER TO SET THE JUMPERS AS NEEDED TO PROGRAM THE SENSING UNIT TO THE COACH.

JP1 AND JP2 - CONTROL BOX ORIENTATION (Page 1 of 2)

MOVE JUMPERS JP1 AND JP2 ACCORDING TO THE ORIENTATION OF THE CONTROL BOX. USE THE DRAWINGS PROVIDED TO DETERMINE WHICH APPLICATION IS FOR THE ORIENTATION OF YOUR CONTROL BOX.

FOR SHIPPING PURPOSES THE (4) JUMPERS ARE SLID ONTO ONE SIDE OF JP1 THROUGH JP4. MOVE ONLY THE JUMPERS NEEDED TO DETERMINE ORIENTATION AND SUSPENSION. LEAVING THE REMAINING JUMPERS AS THEY ARE SHIPPED WILL NOT CAUSE PROBLEMS.

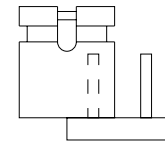
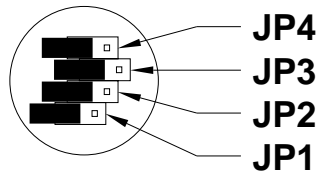

SHIPPED POSITION

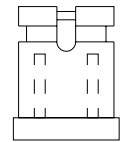

MOVED POSITION

THE FOLLOWING DRAWINGS SHOW THE SENSING UNIT, INSIDE THE CONTROL BOX, AS VIEWED WHEN LOOKING DOWN FROM THE TOP OF THE CONTROL BOX. REMOVE THE RUBBER RING AND PLASTIC COVER ONLY IF NEEDED. THE RING AND COVER MUST BE REINSTALLED.

FRONT OF VEHICLE

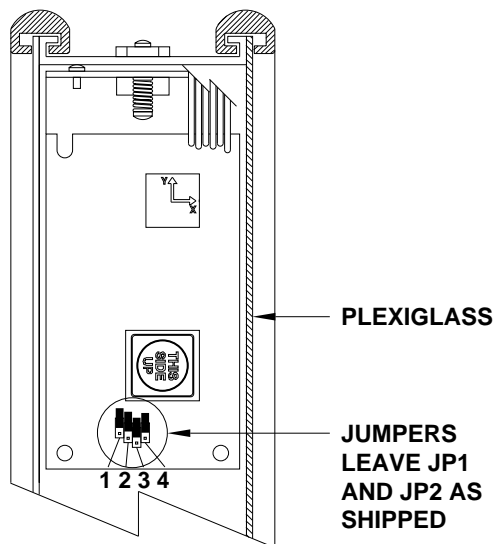

FRONT OF VEHICLE

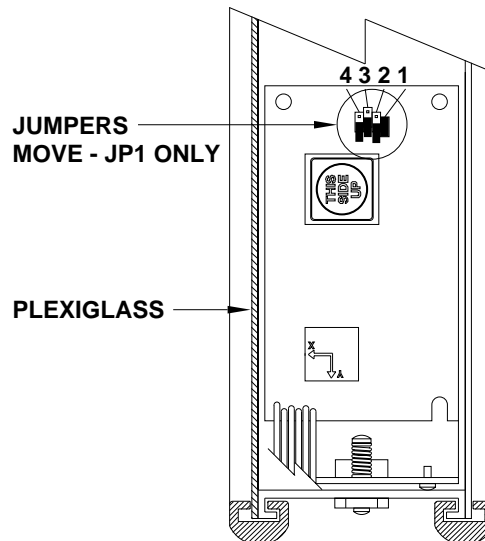

FRONT OF VEHICLE

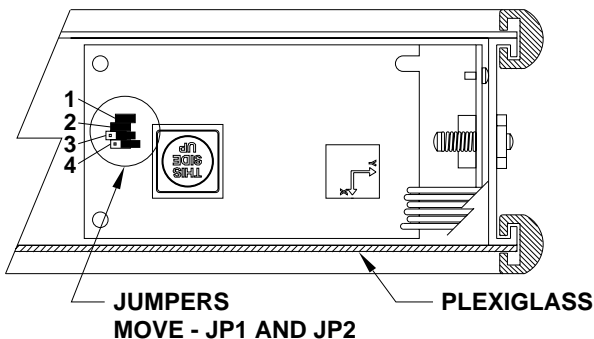

FRONT OF VEHICLE

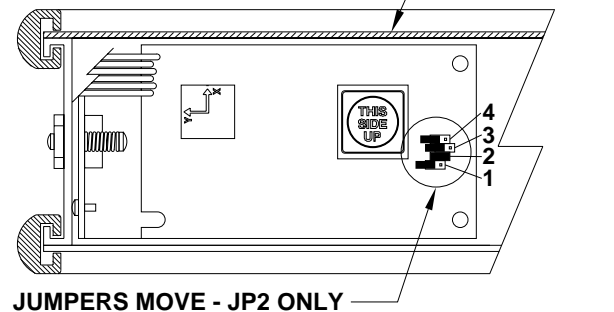



**READ
INSTRUCTIONS
THOROUGHLY
BEFORE
PROCEEDING**

ELECTRICAL CONNECTION DIAGRAM ELECTRONIC SENSING UNIT JUMPER PLACEMENT

IMPORTANT: 325 AND 625 ELECTRONIC SENSING UNITS USED IN AFTER MARKET INSTALLATIONS OR REPLACEMENT SITUATIONS ARE PROGRAMMABLE. DURING INSTALLATION OF A SYSTEM OR REPLACEMENT OF AN ELECTRONIC SENSING UNIT DO NOT ASSUME THAT THE SENSING UNIT JUMPERS ARE PRE-SET. THE MOUNTED ORIENTATION OF THE CONTROL BOX ASSEMBLY AND THE SUSPENSION TYPE MUST BE ESTABLISHED IN ORDER TO SET THE JUMPERS AS NEEDED TO PROGRAM THE SENSING UNIT TO THE COACH.

JP3 AND JP4 - CONTROL SUSPENSION TYPE (Page 2 of 2)

MOVE JUMPERS JP3 AND JP4 ACCORDING TO THE TYPE OF SUSPENSION ON THE VEHICLE.

JUMPERS JP3 AND JP4 DETERMINE SUSPENSION TYPE.

SPRING - LEAVE JUMPERS JP3 AND JP4 AS SHIPPED.
NEITHER JUMPER NEEDS TO BE MOVED.

AIR - LEAVE JUMPER JP4 AS SHIPPED, MOVE JP3 ONLY.
DIAGRAM BELOW SHOWS AIR SUSPENSION SETUP.

