



Aliens™ Extermination

System Manual

040-0120-01 Rev. B

- **Read this manual before use.**
- **Keep this manual with the machine at all times.**



www.globalvr.com
<http://service.globalvr.com>
techsupport@globalvr.com
Phone: 408.597.3435
Fax: 408.597.3437

Table of Contents

Preface	4	Opening the Gun Case	24
Safety	4	Closing the Gun Case	24
Warnings	4	Gun Trigger Service	25
Environmental Conditions	4	Gun Button Service	25
FCC Notices (United States)	5	Gun Coil Assembly Service	26
Chapter 1 — Introduction	6	Gun Pot and Gear Service	27
Cabinet Specifications	7	The Gun PCB	28
Power Requirements (Approximate)	7	GVRI/O PCB Service	29
Hardware Features	7	Start Button Service	29
Chapter 2 — Installing a New Cabinet	8	Wells-Gardner® Monitor Replacement	30
Chapter 3 — Playing a Game	9	Wells-Gardner® Monitor Chassis PCB Removal	31
Chapter 4 — Operator Menu and Game Setup	10	Computer Replacement	33
Navigating the Menus	10	Coin Mech Replacement	34
Main Menu	11	Coin Meter Replacement	34
System Tests Menu	12	Power Distribution Service	34
Using the Gun Test & Calibrate Screens	13	AC Power Plate	34
Coinage Audits Menu	14	AC Power Strip Replacement	35
System Audits Menu	15	DC Power Supply Replacement	35
Game Audits Menu	16	Marquee Florescent Light Service	36
Coinage Adjustments Menu	17	Cold-Cathode Florescent Light Service	36
System Adjustments Menu	18	Setting the Computer BIOS (CMOS)	37
Game Adjustments Menu	19	Chapter 7 — Replacement Parts	39
Gun Adjustments Menu	20	Chapter 8 — Troubleshooting	44
Reset Menu	21	Video Troubleshooting	44
Chapter 5 — Software Restoration	22	Audio Troubleshooting	45
System Recovery Disk	22	Button Troubleshooting	46
Game Install CD	22	Gun Troubleshooting	46
Chapter 6 — Service and Repair	23	Miscellaneous Troubleshooting	47
Speaker Replacement	23	Chapter 9 — Diagrams and Schematics	49
Gun Service	23	Warranty Information	54
		Technical Support	56

List of Figures

Figure 1. Cabinet Dimensions	7	Figure 22. Gun PCB	28
Figure 2. Coin Door with Key Locations	8	Figure 23. Gun Internal Parts	28
Figure 3. Back of the Marquee Front	8	Figure 24. Start Button Assembly	30
Figure 4. Using the Guns	9	Figure 25. Monitor Mounting Nut Locations	31
Figure 5. Operator Buttons	10	Figure 26. Removing the Monitor PCB Mounting Hardware	32
Figure 6. Main Menu	11	Figure 27. Disconnecting the Chassis Neck PCB and Second Anode Lead	32
Figure 7. System Test Screens	12	Figure 28. Monitor PCB Cables	33
Figure 8. Gun Calibration Screens	13	Figure 29. Servicing the Coin Mech and Coin Meter	34
Figure 9. Coinage Audits Menu	14	Figure 30. AC Power Plate (Shown Without Labels)	35
Figure 10. System Audits Menu	15	Figure 31. Cold-Cathode Light Detail	36
Figure 11. Game Audits Menu	16	Figure 32. Cabinet Artwork	41
Figure 12. Coinage Adjustments Menu	17	Figure 33. Gun Exploded-View Drawing	43
Figure 13. System Adjustments Menu	18	Figure 34. GVRI/O Wiring Diagram	49
Figure 14. Game Adjustments Menu	19	Figure 35. Gun Wiring Diagram	50
Figure 15. Gun Adjustments Menu	20	Figure 36. Overall Cabinet Wiring Diagram	51
Figure 16. Reset Menu	21	Figure 37. Power Distribution Diagram	52
Figure 17. Gun Case Screws	24	Figure 38. Computer Rear Panel Diagram	53
Figure 18. Gun Trigger Assembly	25		
Figure 19. Gun Button, Lamp, and Micro Switch	26		
Figure 20. Gun Coil Assembly Service	26		
Figure 21. Gun Pot Replacement	27		

Preface

Safety

Please read this page before preparing your arcade cabinet for game play.

The following safety instructions apply to all game operators and service personnel. Specific warnings and cautions will be included throughout this manual.

Use the following safety guidelines to help protect the system from potential damage and to ensure your personal safety:



- Make sure that the switch on the back of the computer is set to match the AC power in use at your location:
 - 115 volts / 60Hz in most of North and South America and some Far Eastern countries such as Japan, South Korea and Taiwan
 - 230 volts / 50Hz in most of Europe, the Middle East and the Far East
- To help prevent electric shock, plug the system into a properly grounded power source. The AC power cables are equipped with 3-prong plugs to help ensure proper grounding. Do not use adapter plugs or remove the grounding prong from a cable. If you must use an extension cable, use a 3-wire cable with properly grounded plugs.
- To help protect your system from sudden increases and decreases in electrical power, use a surge suppressor, line conditioner or Uninterruptible Power Supply (UPS).
- Be sure nothing rests on the system's cables and that the cables are not located where they can be stepped on or tripped over.
- Keep your system far away from radiators and other heat sources.
- Do not block cooling vents.

Precautions for Game Operation

GLOBAL VR[®] assumes no liability for injuries incurred while playing our games.

Operators should be aware that certain health and physical conditions may make people susceptible to injury when playing video games, particularly when the game moves or creates a sense of motion.

Warnings

	To avoid electrical shock, unplug the cabinet before performing installation or service procedures.
	GLOBAL VR assumes no liability for any damages or injuries incurred while setting up or servicing the cabinet. Only qualified service personnel should perform installation or service procedures!

Environmental Conditions

Cabinet is intended for indoor use only. Be sure to keep the cabinet dry and maintain operating temperatures of 10°-40°C (50°-104°F).

FCC Notices (United States)

Electromagnetic Interference (EMI) is any signal or emission radiated in free space or conducted along power or signal leads, that endangers the functioning of radio navigation or other safety service, or that seriously degrades, obstructs, or repeatedly interrupts a licensed radio communications service. Radio communications services include, but are not limited to, AM/FM commercial broadcast, television, cellular services, radar, air-traffic control, pager, and Personal Communication Services (PCS). These licensed services, along with unintentional radiators such as digital devices (including computer systems) contribute to the electromagnetic environment.

Electromagnetic Compatibility (EMC) is the ability of items of electronic equipment to function properly together in the electronic environment. While this computer system has been designed and determined to be compliant with regulatory agency limits for EMI, there is no guarantee that interference will not occur in a particular installation. If this equipment does cause interference with radio communications services, which can be determined by turning the equipment off and on, you are encouraged to try to correct the interference by one or more of the following measures:

- Re-orient the receiving antenna.
- Relocate the cabinet relative to the receiver.
- Plug the game into a different outlet so that the computer and the receiver are on different branch circuits.

If necessary, consult an experienced radio/television technician for additional suggestions. You may find the [FCC Interference Handbook](#), to be helpful. It is available from the U.S. Government Print Office, Washington, DC 20402.

This device has been tested and complies with the limits for a Class A digital device pursuant to Part 15 of the FCC Rules. These limits are designed to provide reasonable protection against harmful interference when the equipment is operated in a commercial environment. This equipment generates, uses, and can radiate radio frequency energy. If not installed and used in accordance with the instruction manual, it may cause harmful interference with radio communications. Operation of this equipment in a residential area is likely to cause harmful interference, in which case you will be required to correct the interference at your own expense.

Operation is subject to the following conditions:

- This device may not cause harmful interference.
- This device must accept any interference received, including interference that may cause undesired operation.

Chapter 1 — Introduction



THIS IS NOT JUST ANOTHER BUG HUNT!

It's been years since the Colonial Marines left planet LV-426 and the Alien population behind. It's time to go back to finish off the Alien race...and more!

The world seems familiar, but the scenario is not.

Since the Marine's last visit, the *Weyland-Yutani Corporation* reprogrammed an army of synthetic humans to stop anything from getting in the way of the company's development of their deadly Bio Weapons. It's not as simple as just killing the Alien Queen any more.

Game Features:

- Force-feedback recoil gun action
- 2 player simultaneous cooperative action
- Original licensed characters
 - Colonial Marines, Face Hugger, Warrior Aliens, and Eggs
- State of the art arsenal includes:
 - M41-A Pulse Rifle, Flamethrower, Grenades, and Missile Launcher
- Power-Up for Health, Ammo, Grenades, Missiles, and Flame Canisters
- 4 Levels of Nail Biting Action
- Two Different Play Modes – Story and Chapter

Cabinet Specifications



Figure 1. Cabinet Dimensions

Power Requirements (Approximate)

- Inrush AC Current: 7 Amps
- Operating AC Current: 5 Amps
- Voltage: 115 VAC

Hardware Features

- Pentium® 4 computer
- Nvidia® GeForce® graphics
- 512 megabytes RAM
- 27-inch, 800 x 600, Super VGA flat-screen monitor
- Supports dollar bill validator
- Unique cabinet configuration with dramatic lighting effects
- Mounted guns with force-feedback recoil action and LED ammo readout
- USB Gun interface

Chapter 2 — Installing a New Cabinet

Use the following procedure to install a new cabinet:

1. Carefully remove the cabinet from the shipping container, giving yourself plenty of space around the cabinet. Inspect the exterior of the cabinet for any damage.
2. Remove the keys from the coin return slot. Open the coin door to locate the second set of keys (see Figure 2).

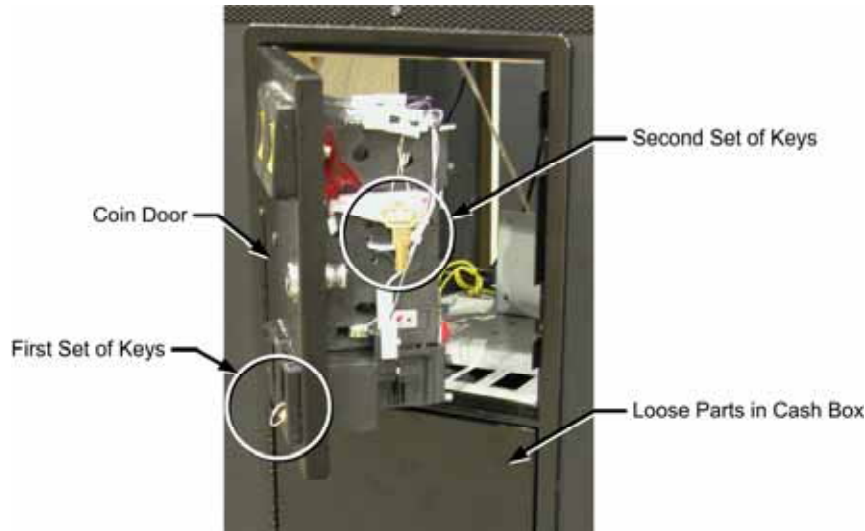

Figure 2. Coin Door with Key Locations

3. Unpack the marquee front. Remove the five (5) nuts and washers from the pre-installed screws with standoffs, shown by the rectangles below. (Leave the standoffs in place.) Remove the three (3) wood screws, shown by the circles below, from the back of the support piece at the top. Use this hardware to secure the marquee front in place on top of the cabinet.
4. Connect the AC power cord to a grounded outlet and power on the game.
5. Play a game to verify everything is working properly.
6. Refer to Chapter 4 for information on using the Operator menus to set up your game.



Figure 3. Back of the Marquee Front

Chapter 3 — Playing a Game

Playing the game is easy and intuitive. Blast the aliens, but don't hit the other marines!

1. Insert coins and press the START button next to the gun you want to use.
2. Select Story mode, where you start at the beginning, or Chapter mode, where you pick your starting level. (You can disable Chapter mode from the Operator menu.)
3. Shoot at the aliens with guns, flamethrower, grenades and rockets as you automatically move through the base. See the picture below for special features of the gun.
4. Don't shoot the other marines! Hitting them depletes your health.
5. Shoot at weapons and medical kits to increase your ammunition and health. Gather special weapons and fuel for your flamethrower.
6. When your game is about to end, a countdown appears onscreen. To continue, insert coins and press the START button on your side.



Figure 4. Using the Guns

Chapter 4 — Operator Menu and Game Setup

This chapter describes the Game Operator menus, their functions, and default settings. These menus let you set up the game, diagnose problems, and view gameplay and earnings statistics.

Navigating the Menus

1. Open the coin door and press the red **TEST/BACK** button to open the Operator **Main Menu**.
2. Use the **VOL UP** and **VOL DN** buttons to navigate through the list of menu items. Each item will flash as it is highlighted.
3. Press the green **SELECT** button to open a sub-menu or select an item when it is highlighted.
4. To change the setting for a menu item, highlight the item and press **SELECT**, and then use the **VOL UP** and **VOL DN** buttons to modify the setting. When you finish, press **TEST/BACK** to exit from the item.
5. The last item in each submenu will take you back to the previous menu when you press **SELECT**. (Pressing the **TEST/BACK** button to automatically highlight this item.)
6. Once you get back to the **Main Menu**, highlight **EXIT TO GAME** and press **SELECT** to return to the Attract Mode.

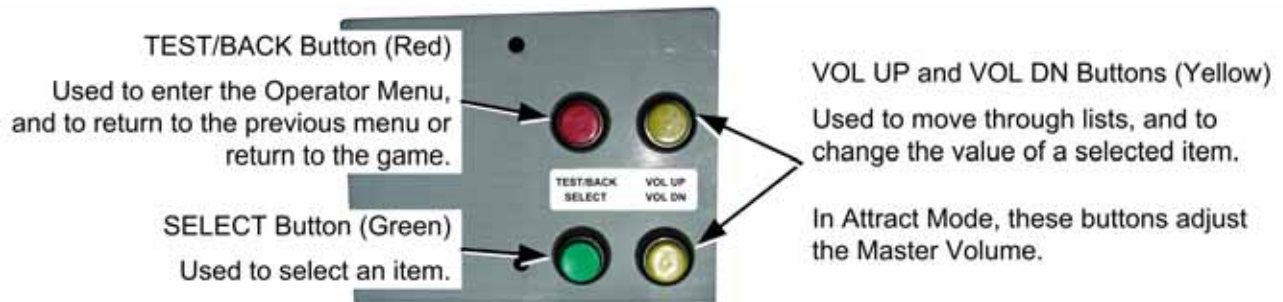

Figure 5. Operator Buttons

Main Menu

The main menu appears first when you press the **TEST/BACK** button. This is the starting point for all features of the Operator Menus.

The information box that appears on the right side of this screen lists important information about the hardware and software in the game.

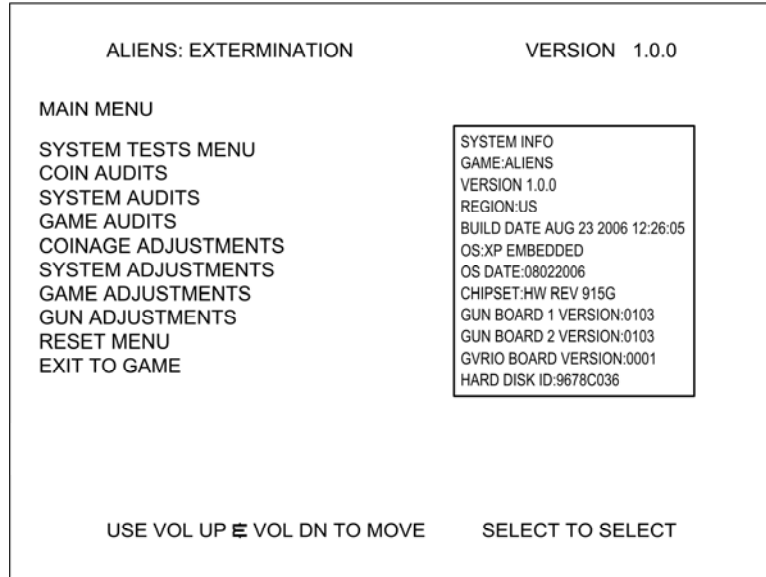

Figure 6. Main Menu

Menu Item	Description
SYSTEM TESTS MENU	Opens System Tests where you can test and calibrate the guns, test the buttons, switches, and audio, or display video test screens to help you adjust the video.
COIN AUDITS	Opens Coinage Audits where you can view earnings statistics.
SYSTEM AUDITS	Open System Audits where you can view basic game play statistics.
GAME AUDITS	Opens Game Audits where you can view detailed game play statistics.
COINAGE ADJUSTMENTS	Opens Coinage Adjustments where you can set up pricing and coin mechs.
SYSTEM ADJUSTMENTS	Opens System Adjustments where you can set up audio volume and attract mode sounds, and set the video gamma.
GAME ADJUSTMENTS	Opens Game Adjustments where you can set the minimum game time and turn the Chapter Select Screen on or off.
GUN ADJUSTMENTS	Opens Gun Adjustments where you can set up gun features, or flip the guns if they should happen to be wired backwards.
RESET MENU	Opens Reset Menu where you can clear credits, audits, and adjustments, or return the game to factory default settings.
EXIT TO GAME	Returns you to the Attract Mode.

System Tests Menu

Each item in the System Tests menu opens another menu, as shown below, that lets you test various game functions.

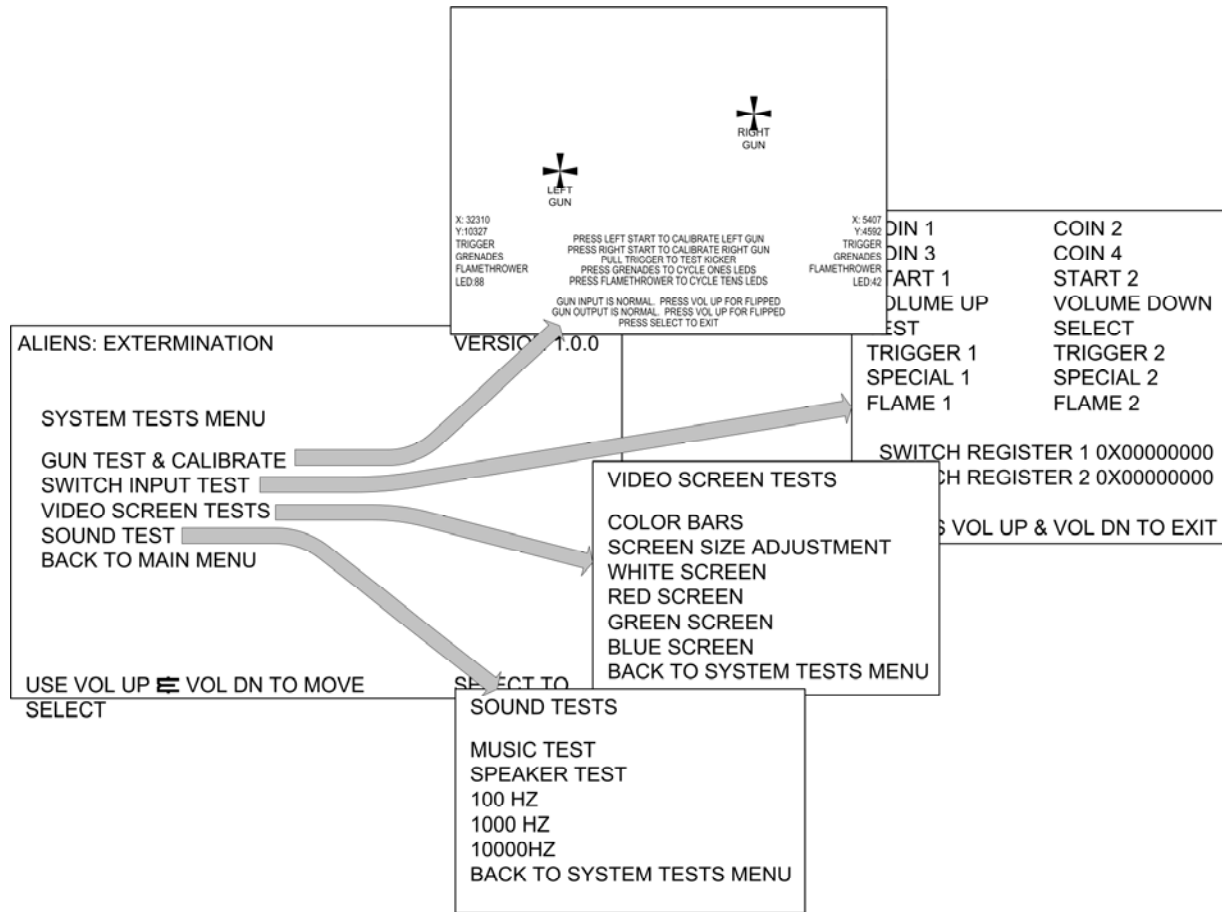

Figure 7. System Test Screens

Menu Item	Description
GUN TEST & CALIBRATE	The Gun Calibration screens allow you to calibrate the guns so they aim properly. Refer to <i>Using the Gun Test & Calibrate Screens</i> , on page 13, for instructions on calibrating the guns.
SWITCH INPUT TEST	The Switch Input screen lists each switch on the cabinet. To confirm a switch is working, operate the switch and observe that it highlights on the screen. Press the VOL UP and VOL DN buttons together to exit from the test screen.
VIDEO SCREEN TESTS	Each item on the Video Screen Tests menu opens a screen that helps you adjust the video using the monitor remote control board located inside the coin door. Press the Select button to close these screens.
SOUND TEST	The items on the Sound Tests menu help you diagnose audio problems. Music Test plays music to help you judge audio quality. Speaker Test plays each speaker in turn, followed by both speakers in stereo. The remaining items each play a tone at the stated frequency, to test the speaker frequency response.
BACK TO MAIN MENU	Returns you to the Main Menu.

Using the Gun Test & Calibrate Screens

1. Select **GUN TEST & CALIBRATE** from the System Tests menu. The screen shown below on the left will open. Observe the lists on the left and right side of the screen. Each of these provides information about the gun on that side of the cabinet.
2. Move a gun and observe the corresponding icon moving on the screen. When the gun is properly calibrated, you should be able to move the icon all around the edge of the screen, without going off the screen. Note that the coordinate numbers next to X and Y on the screen change as you move the gun.
3. Press the Trigger, Flamethrower, and Grenade buttons and observe that the corresponding word changes color onscreen. You should also feel the *Kicker* (force-feedback recoil) when you pull the trigger.
4. To test the gun LED display, press the Grenade button to cycle the ones-place LED, and press the Flamethrower button to cycle the tens-place LED. Confirm all LED segments light, and the readout matches the onscreen number next to LED for that gun.
5. To calibrate the right gun (Player 2), press the START button for that gun.
6. The Gun Calibration screen, shown below on the right, will appear. When the screen first appears, only the **PLAYER 2 GUN LEFT** numbers will be visible, and a blue triangle will be visible at the far left of the screen, as shown below.
As you move the gun, the numbers next to **PLAYER 2 GUN LEFT** will change, indicating the gun position. Point the gun at the far left of the screen, as indicated by the triangle, and pull the trigger to set the position.
7. Once you set the **LEFT** position, **PLAYER 2 GUN RIGHT** will automatically become active, and a blue triangle will appear at the far right of the screen. Move the gun all the way to the right and pull the trigger.
8. Set the **UP** and **DOWN** positions the same way. Once you set the **DOWN** position, the screen shown below on the left will appear again.
9. When finished testing guns, press the **SELECT** button to return to the System Tests Menu.

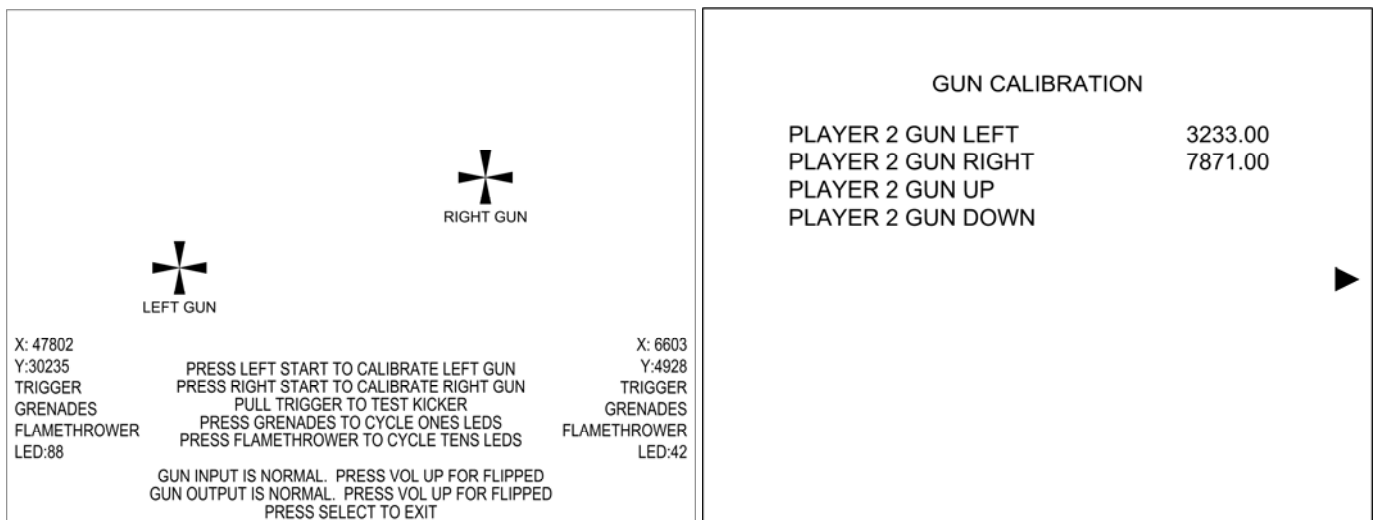

Figure 8. Gun Calibration Screens

Coinage Audits Menu

This screen provides basic coin count information.

ALIENS: EXTERMINATION	VERSION 1.0.0
COINAGE AUDITS	
COIN 1	289
COIN 2	124
COIN 3	0
COIN 4	0
PAID CREDITS	413
UNSPENT CREDITS	1
LIFETIME COIN COUNT	734
BACK TO MAIN MENU	
USE VOL UP \square VOL DN TO MOVE SELECT TO SELECT	

Figure 9. Coinage Audits Menu

Menu Item	Description
COIN 1	Displays current coin count for COIN 1, used for coin mechs 1 and 2.
COIN 2	Displays current coin count for COIN 2, used for the optional dollar bill validator.
COIN 3	Not used.
COIN 4	Not used.
PAID CREDITS	Displays total credits inserted since the last reset.
UNSPENT CREDITS	Displays credits currently available.
LIFETIME COIN COUNT	Displays total credits inserted since the software was installed.
BACK TO MAIN MENU	Returns you to the Main Menu.

System Audits Menu

This screen provides basic game play statistics.

ALIENS: EXTERMINATION		VERSION 1.0.0	
SYSTEM AUDITS			
UP TIME	0Y 36D	14:25:38	
PLAY TIME	0Y 2D	2:15:29	
1P TIME	64.9%		
2P TIME	36.1%		
PLAYER 1 STARTS	1325		
PLAYER 2 STARTS	663		
BACK TO MAIN MENU			
USE VOL UP  VOL DN TO MOVE		SELECT TO SELECT	

Figure 10. System Audits Menu

Menu Item	Description
UP TIME	Displays total time the cabinet has been turned on since the software was installed. Format is: years days hours:minutes:seconds
PLAY TIME	Displays total game play time since the software was installed. Format is: years days hours:minutes:seconds
1P TIME	Displays the percent of total play time that is for Player 1.
2P TIME	Displays the percent of total play time that is for Player 2.
PLAYER 1 STARTS	Displays the number of times a game has been started for Player 1.
PLAYER 2 STARTS	Displays the number of times a game has been started for Player 2.
BACK TO MAIN MENU	Returns you to the Main Menu.

Game Audits Menu

The Game Audits Menu provides access to all of the game audit screens, where you can view game play and earnings statistics.

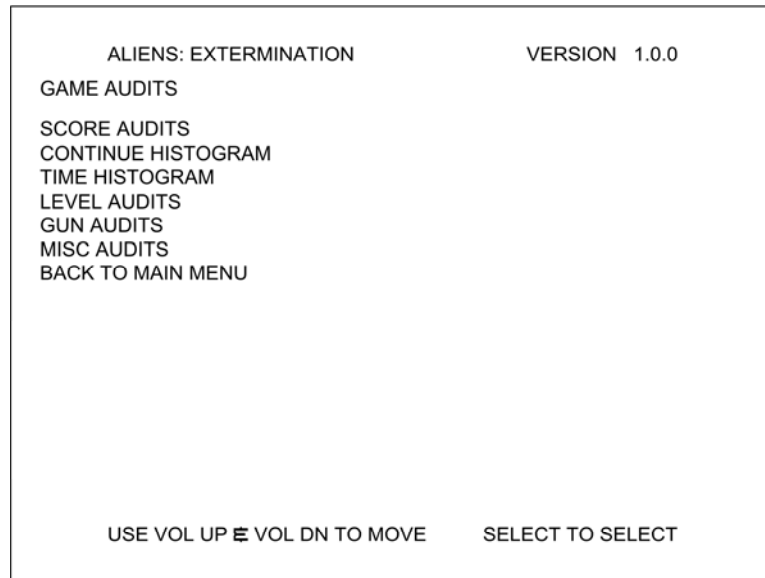

Figure 11. Game Audits Menu

Table 1. Game Audits Menu Items

Menu Item	Description
SCORE AUDITS	Displays the average score and high score for the cabinet.
CONTINUE HISTOGRAM	Opens the Continue Histogram, a graph that shows how many players have continued from each level.
TIME HISTOGRAM	Opens the Time Histogram, a graph that shows how many players have played for specific lengths of time.
LEVEL AUDITS	Displays start and finish information for each game play level.
GUN AUDITS	Displays detailed statistics on how players have used the various weapons, including the number of shots and hits, and power-ups collected.
MISC AUDITS	Displays additional detailed game play statistics.
BACK TO MAIN MENU	Returns you to the Main Menu.

Coinage Adjustments Menu

The Coinage Adjustments Menu lets you set up the coin mechs and set game pricing.

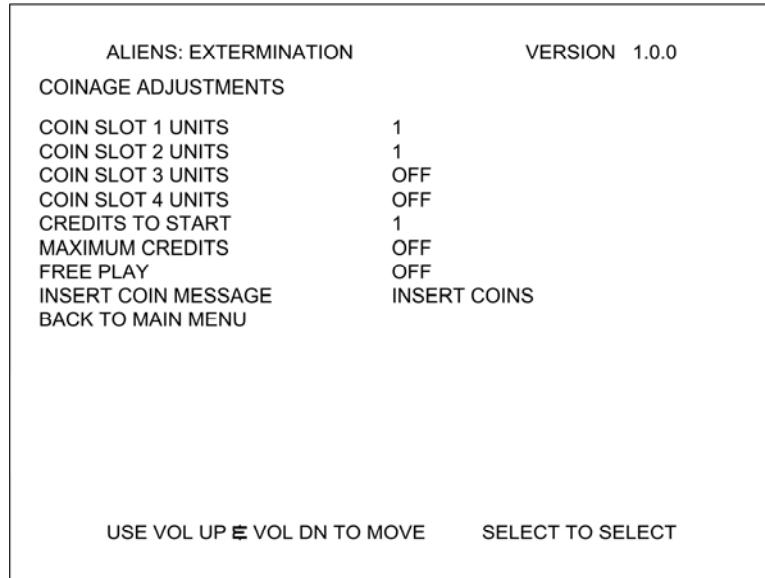

Figure 12. Coinage Adjustments Menu

Table 2. Coinage Adjustments Menu

Menu Item	Description
COIN SLOT 1 UNITS	Sets the units per coin drop for the selected coin slot. Coin Slot 1 is used for both coin mechs. Coin Slot 2 is used for the optional Dollar Bill Validator (DBV). Coin Slots 3 & 4 are not currently supported.
COIN SLOT 2 UNITS	
COIN SLOT 3 UNITS	
COIN SLOT 4 UNITS	
CREDITS TO START	Sets the number of credits to start a game.
MAXIMUM CREDITS	Sets the maximum number of credits that can be inserted at one time (1—99), or set to OFF for no maximum.
FREE PLAY	Turns Free Play On or Off
INSERT COIN MESSAGE	Sets the payment message displayed in Attract Mode. (Options: Insert Coins, Insert Card, Insert Key, Swipe Card)
BACK TO MAIN MENU	Returns you to the Main Menu.

System Adjustments Menu

This screen provides audio adjustments and video gamma settings.

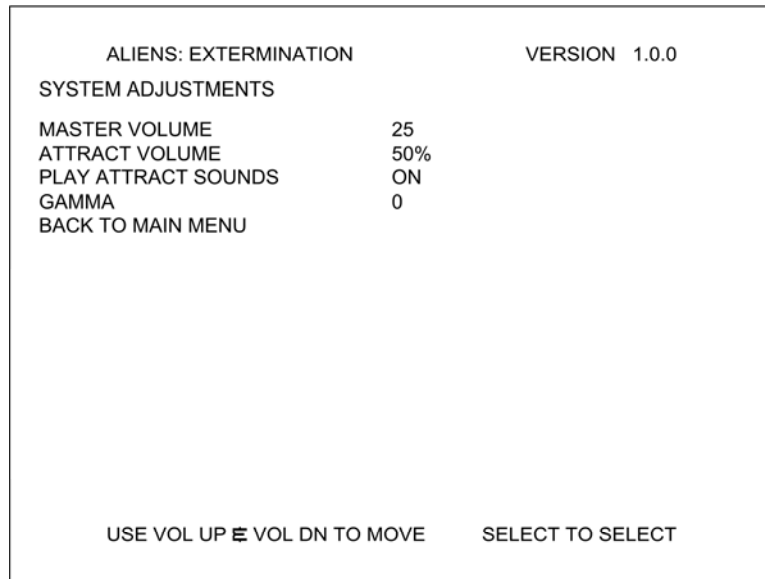

Figure 13. System Adjustments Menu

Menu Item	Description
MASTER VOLUME	Increases or decreases the Master volume. Plays music during adjustment to help you judge the setting. (Range is 0—100.) (This has the same effect as using the VOL UP & VOL DN buttons in attract mode.)
ATTRACT VOLUME	Sets the Attract Mode volume as a percent of the Master Volume.
PLAY ATTRACT SOUNDS	Sets whether the Attract Mode plays sound effects (Alien scream, etc.) Options are ON, OCCASIONALLY, or OFF.
GAMMA	Increases or decreases the overall screen brightness.
BACK TO MAIN MENU	Returns you to the Main Menu.

Game Adjustments Menu

This screen allows you to set some game play timing settings, turn the Chapter Select option on or off, and select whether to play all five levels or only the three that are less violent.

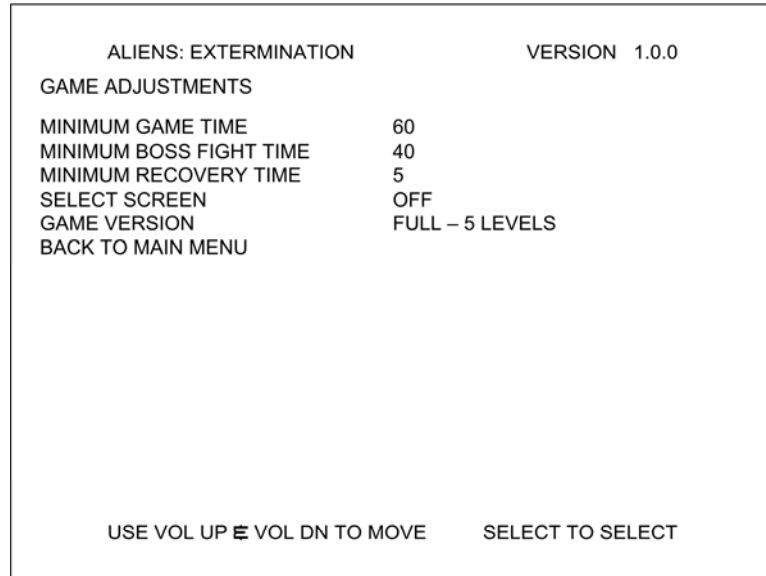

Figure 14. Game Adjustments Menu

Menu Item	Description
MINIMUM GAME TIME	Sets the minimum time a game will run, in seconds. Ensures less skilled players get at least this much gameplay time. (Range: OFF—180; Default: 80)
MINIMUM BOSS FIGHT TIME	Sets the minimum gameplay time for the boss fight at the end of a level, in seconds. Overrides 'MINIMUM GAME TIME' setting during boss fights. (Range: OFF—180; Default: 40)
MINIMUM RECOVERY TIME	Grace period, in seconds, after a player is hit until the player can be hit again. (Range: OFF—20; Default: 3)
SELECT SCREEN	Turns the Chapter Select screen ON or OFF. Turning this ON allows players to pick which chapter they want to play; OFF forces them to start at the beginning of the story. (Default: ON)
GAME VERSION	Sets game to FULL - 5 LEVELS or LITE - 3 LEVELS. LITE plays in Story Mode only, and omits the two levels that are the most violent. (Default: FULL)
BACK TO MAIN MENU	Returns you to the Main Menu.

Gun Adjustments Menu

This screen allows you to adjust how the guns perform.

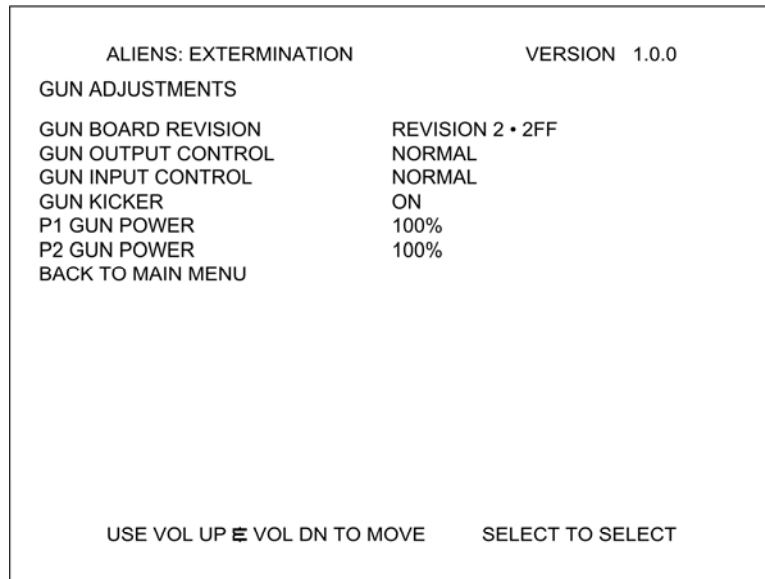

Figure 15. Gun Adjustments Menu

Menu Item	Description
GUN BOARD REVISION	Set this to the version of gun board installed.
GUN OUTPUT CONTROL	These options let you compensate if the guns are wired backwards (for example, if firing Gun 1 causes recoil in Gun 2). Setting both options to FLIPPED will reverse the input and output signals the guns send to the system computer. (Options: NORMAL or FLIPPED)
GUN INPUT CONTROL	
GUN KICKER	Turns gun force feedback recoil ON or OFF.
P1 GUN POWER	Sets the strength of the force feedback recoil for the selected gun. 100% is considered normal. Higher numbers make the recoil stronger; lower numbers make the recoil weaker. (Options: 25%-133%; Default: 100%)
P2 GUN POWER	
BACK TO MAIN MENU	Returns you to the Main Menu.

Reset Menu

This menu lets you reset high scores, credits, audits, and adjustments, or restore the cabinet to factory defaults. Be aware that when you highlight an item and press the SELECT button, there is no confirmation screen—the reset occurs immediately.

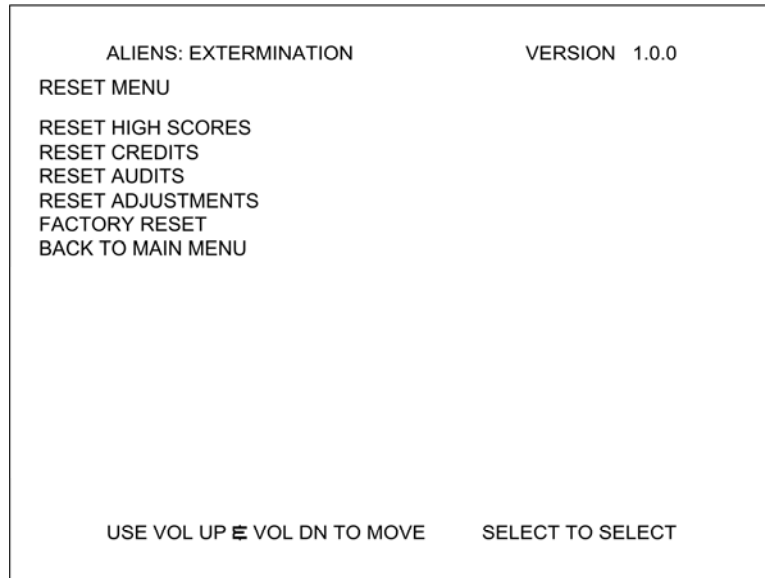

Figure 16. Reset Menu

Menu Item	Description
RESET HIGH SCORES	Deletes the high scores saved and displayed in the game.
RESET CREDITS	Sets inserted credits to zero (0).
RESET AUDITS	Sets all audits to zero (0). Does not affect lifetime totals or game settings.
RESET ADJUSTMENTS	Returns all adjustments to default values.
FACTORY RESET	Returns all settings to factory default values. Does not affect audits.
BACK TO MAIN MENU	Returns you to the Main Menu.

Chapter 5 — Software Restoration



Follow the instructions below if you need to re-install software on your cabinet. Total installation time is about 15-20 minutes.

Important: When you use the System Recovery Disk, you will erase all game settings, and coin and game audits. It is advisable to contact Technical Support before using the System Recovery Disk to resolve a problem.

System Recovery Disk

1. With the cabinet powered ON, open the CD drive and insert the CD labeled **System Recovery Disk**. Power the cabinet OFF and then ON. The computer will boot from the CD, and you will see the Symantec™ Ghost installer screen on the monitor.
2. After about 5 minutes, when you are prompted, remove the CD and turn the cabinet OFF and then ON. (**Do not** insert the Game Install CD yet!)
3. When the computer reboots, you will see a series of processing screens. After about 3 minutes the computer will automatically reboot. You will briefly see a message to insert Game Disk 1, followed by the GLOBAL VR logo on the screen. Proceed to install the Game Install CD as described below.

Game Install CD

1. Open the CD drive and insert the CD labeled **Game Install Disk 1 of 1**. The computer will read the CD automatically (do not reboot). You will see the Installer screen as the software copies files, and after about 5 minutes the computer will reboot. (**Note:** During boot you will see Adjustment and High Score file error messages since these files are erased during system recovery.)
2. After about 2 minutes more, the game will start. Remove the disk from the CD drive.
3. Play a game to verify proper operation.
4. Press the Operator **TEST/BACK** button to enter the Operator Menus and set up your game.

Chapter 6 — Service and Repair



CAUTION: GLOBAL VR assumes no liability for any damage or injuries incurred while servicing the cabinet. Only qualified service personnel should perform service and installation of cabinet hardware.

To prevent electrostatic discharge (ESD) damage, handle PCBs by the edges only and use a grounding wrist strap or similar precaution.

Please read the service instructions before working on the cabinet.



Always turn the cabinet OFF and disconnect the AC power cord before performing any repair work.

Speaker Replacement

The two speakers are located behind the grill below the monitor.

1. Remove the four (4) Torx[®] security screws that secure the speaker grill to the cabinet.
2. Remove the four (4) screws that secure the speaker to the cabinet.
3. Remove the wires from the speaker and install them to the same connectors on the replacement speaker.
4. Reverse these steps to re-install the speaker.
5. Run the **Sound Test** from **System Tests** in the Operator Menu to verify proper operation.

Gun Service

The subsections that follow describe steps for testing and replacing the gun components.

The gun body contains micro switches for the trigger, grenade button, and flamethrower button, and a coil and plunger assembly that creates the force-feedback recoil effect when the gun is fired. To service these parts, you need to open the gun case. See Figure 23 for a view of the open gun assembly.

The base of the gun contains pots that relay the gun position to the computer. If the gun position is not being read properly, refer to the gun pot service steps on page 27. You **do not** need to open the gun case to test or replace the pots.

Important: If the guns are connected to the PCI USB ports, connect them according to the label above the ports. The ports used may vary depending on the brand of PCI USB card used. Guns can also be connected to the motherboard USB ports. See Figure 38 on page 53 for more information.

Gun Power Harness Fuses

The gun power harness has two fuses, one for each gun. If a gun has no power, check the fuse and replace if necessary. Spare fuses are taped to the harness near the fuse holder. Replace with MDL 2A Slo Blo fuses.

Opening the Gun Case

Open the gun case to service the trigger, buttons, and coil assembly. You **do not** need to open the case to service the pots that aim the gun (see page 27). See Figure 23 for a view of the open gun assembly

1. To open the gun case, first remove the 12 Torx security screws shown by the single arrows in the picture below, and remove the corresponding nuts from the other side of the gun.
2. Remove the four screws shown by the double arrows in the picture below. These screw into the frame, so there are no nuts to remove.
3. Carefully remove the left side cover from the gun, being careful not to pull the wires from the grenade button on the cover. The wires are long enough that you can set the cover on the control panel near the gun without disconnecting the wires.



Figure 17. Gun Case Screws

Closing the Gun Case

1. To close the gun case, first align the slots that fit around the gun PCB (with the LED display), and then carefully put the two halves together. Make sure no wires or components get caught or pinched. Pay special attention to the area around the trigger and spring, the wires coming out of the frame shaft, and the wires attached to the coil and barrel light.
2. Insert the four (4) 3/8" x 10-32 screws shown with the double arrows in Figure 17. Partially tighten all four screws, verify the case is mating properly, and then tighten the screws snugly.
3. Check the trigger to make sure it works properly. The trigger or spring could shift while you are assembling the case.
4. Replace the remaining 8-32 screws and nuts, shown by the single arrows above, and tighten snugly. The screw at the top of the muzzle end is 3/4" long, and the two screws in the handle are 1" long, as shown above. All of the other screws are 1 1/4" long.

Gun Trigger Service

To replace the trigger spring, refer to the picture below for the placement of the spring in the gun housing.

Install the plastic trigger so it presses against the spring, and the bottom part of the trigger will press the switch actuator when a player pulls the trigger.

To replace the micro switch, remove the two screws that secure the switch in place. Remove the two wires and install them on the same terminals on the replacement switch.

Be sure to connect the signal wire to the **NO** connector (middle connector) and the black ground wire to the **C** connector.

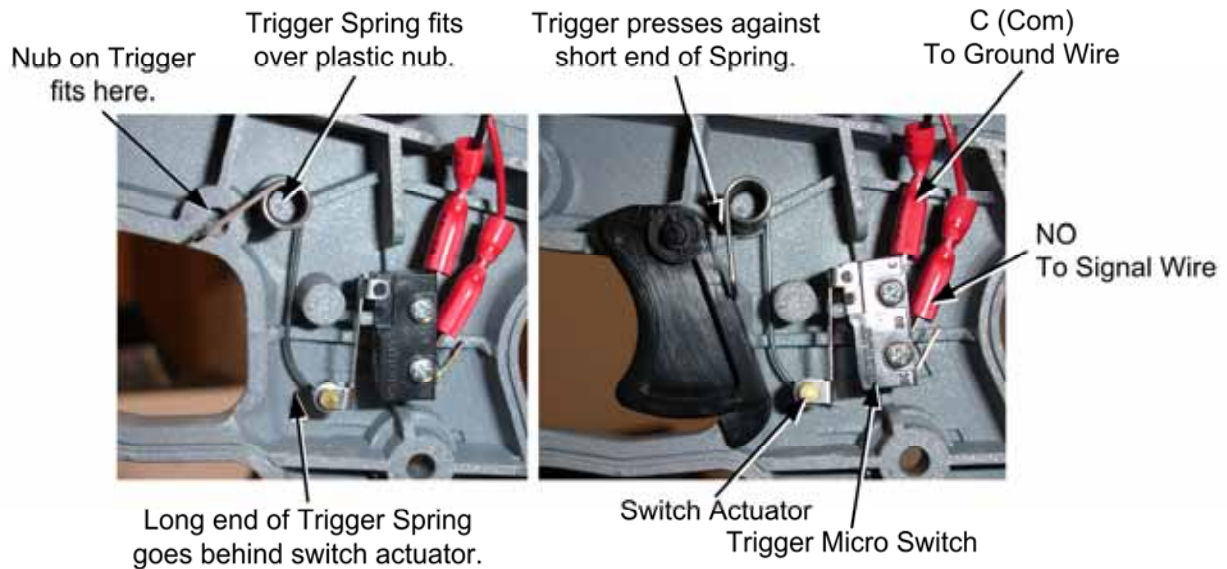

Figure 18. Gun Trigger Assembly

Gun Button Service

Refer to Figure 19 for components of the lighted buttons used for the grenade and flamethrower features.

If you replace a button micro switch, be sure to connect the signal wire to the **NO** connector (middle connector) and the black ground wire to the **C** connector. If you connect the wires differently the button will not work.

To replace the light bulb, pull the lamp assembly straight out of the button housing, and then pull the bulb straight out of the lamp housing. The two lamp wires are interchangeable and can connect to either terminal on the lamp housing.

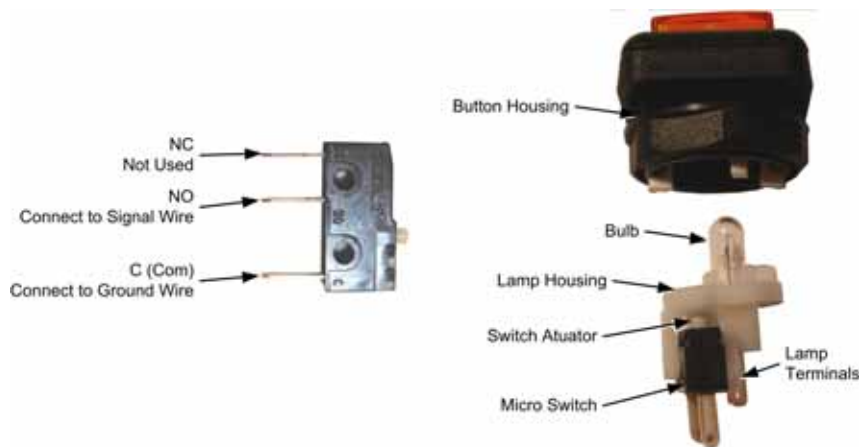

Figure 19. Gun Button, Lamp, and Micro Switch

Gun Coil Assembly Service

The coil assembly provides the force-feedback recoil when the gun is fired. Perform the following steps to replace components of the coil assembly:

1. Open the gun case as described on page 24.
2. Remove the two screws shown below from the right side of the gun.



3. Remove the nut that secures the ground wire to the ground lug on the side of the coil assembly mounting plate, as shown below.
4. Remove the two screws that secure the coil assembly mounting plate to the gun shaft, as shown below.

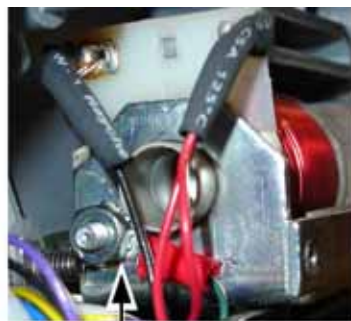

Ground Wire to Ground Lug
Important: Be sure to reconnect this wire!

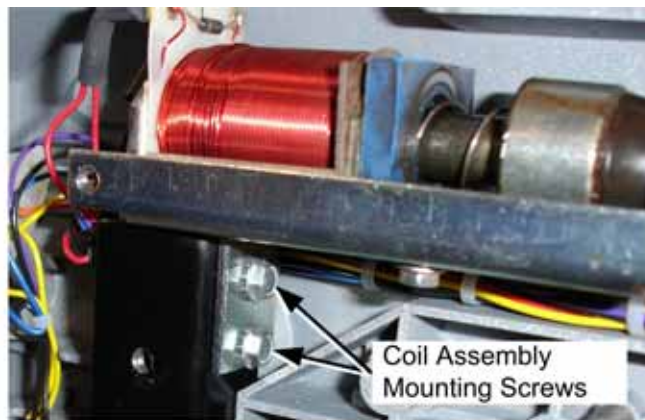

Coil Assembly
 Mounting Screws

Figure 20. Gun Coil Assembly Service

5. Reverse these steps to re-install the coin assembly. Be sure to secure the ground wire to the ground lug on the coil assembly mounting plate.

Gun Pot and Gear Service

Each gun has two pots that measure the movement of the gun on the X-axis (left and right) and Y-axis (up and down). The X-axis pot is located under the gun base below the trigger. The Y-axis pot is located on the side of the gun base below the flamethrower button.

Use the **Gun Test & Calibrate** screen from **System Tests** in the Operator menu to test gun motion. To test a pot, power off the game and test resistance at the pot. When you move the gun, you should see a steady linear increase or decrease in resistance, with no jumps. Replace the gears if they are worn or cracked.

Refer to Figure 21 for gun base components, and perform the following steps to replace a pot or gear shaft:

1. Remove the six (6) Torx security screws that secure the front and rear covers over the gun base, and remove the covers.
2. Remove the two mounting nuts and remove the metal mounting plate from the pot to be replaced.
3. Use an Allen wrench to loosen the set screw from the gear shaft, and remove the gear shaft.
4. Using a 1/2" wrench, remove the nut and lock washer that secure the pot to the frame.
5. De-solder the wires from the pot and solder them on the same terminals on the replacement pot.
6. Install the new 5K Ω pot with the same orientation. Make sure that the plastic keys on the pot mate properly with the metal.
7. Re-install the lock washer and nut, being careful not to over-tighten.
8. Re-install the gear shaft and tighten the set screw.
9. Calibrate the gun using the **Gun Test & Calibrate** screen from **System Tests** in the Operator menu after replacing a pot.

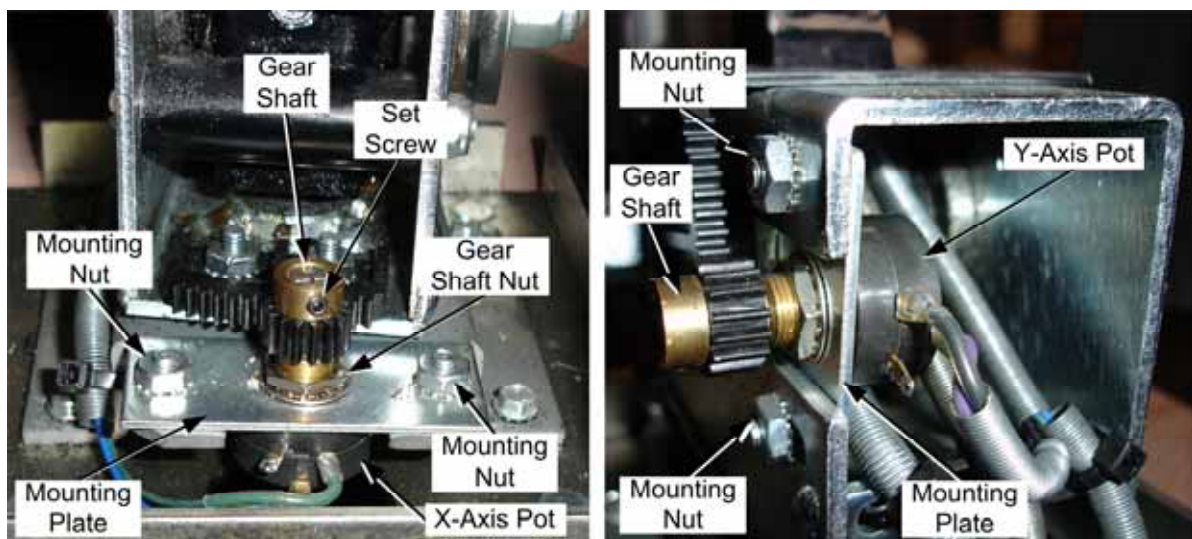

Figure 21. Gun Pot Replacement

The Gun PCB

The Gun PCB routes all signals within the gun, and between the gun and the system computer. It also has an LED display that shows remaining ammo during game play. Each connector on the Gun PCB is keyed to fit only to the correct harness connector. Refer to the picture below to locate the connectors on the PCB. See Figure 35 on page 50 for detailed gun wiring information.

To replace the PCB, open the gun case as described on page 24. Slide the PCB out of the case and disconnect all connectors.

Caution: Disconnect the cabinet from AC power before making any connections to the Gun PCB. Hot-plugging any connector will damage the PCB.

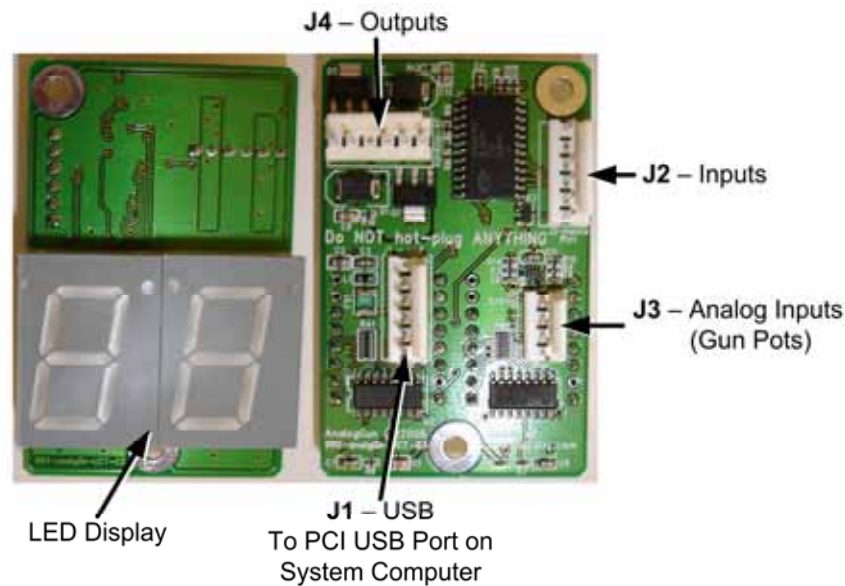

Figure 22. Gun PCB

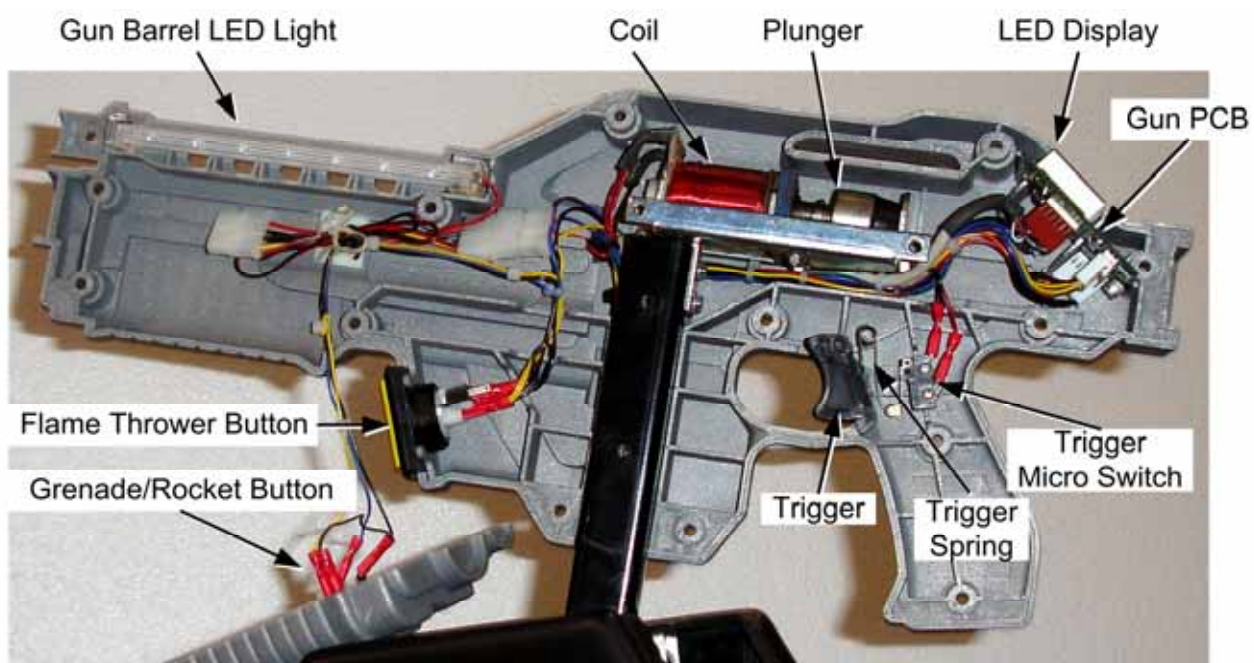

Figure 23. Gun Internal Parts

GVRI/O PCB Service

The GVRI/O PCB relays all signals between the system computer and the controls. Each connector on the GVRI/O PCB is keyed to fit only to the correct harness connector. Refer to the picture below to locate the connectors and fuses on the PCB. The two 5 Amp fuses are for the coin meter power wire only. See Figure 34 on page 49 for detailed wiring information.

Caution: Disconnect the cabinet from AC power before changing the fuses or making any connections to the PCB.

Important: The USB port on the GVRI/O PCB must be connected to either a motherboard USB port, or a specific port on the PCI USB card in the system computer, as shown on the label above these ports (see Figure 38 on page 53 for more information).

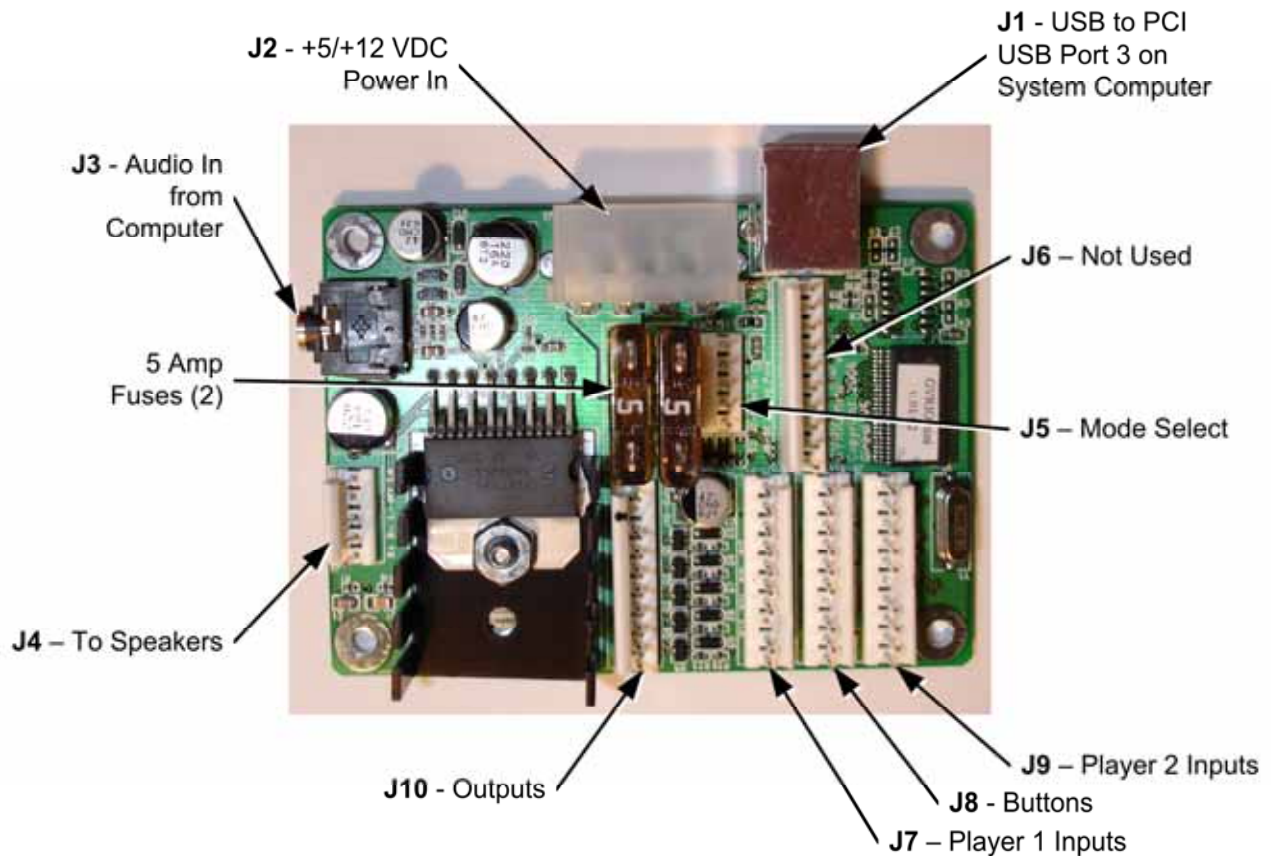

Start Button Service

The Start buttons for each player are illuminated with 12-volt lamps. Refer to Figure 24 and perform the following steps to replace the buttons, lamps, and micro switches:

1. Disconnect the cabinet from AC power.
2. Open the coin door and reach up under the control panel to access the buttons.
3. To remove a micro switch, gently rock it to the side and remove it from the housing. Remove the wires and install them on the same connectors on the new micro switch.
4. To remove the lamp housing, gently rock the white plastic housing from side to side to pop it out of the button housing.

5. To remove the button from the control panel, unscrew the retaining ring from under the control panel.
6. To remove a lamp from the housing for replacement, pull it straight out of the lamp housing.
7. When connecting the wiring to the micro switch and lamp, refer to the labels on the wires and the figure below to make sure the connections are correct.

Caution: Do not connect the 12-volt lamp power wire to the micro switch. This could damage the GVRI/O PCB.

8. Reverse these steps to install the replacement button and micro switch. Connect the ground wire to the COM connector on the bottom of the switch housing, and the signal wire to the NO connector, as shown in the figure below. **Do not** use the NC connector.

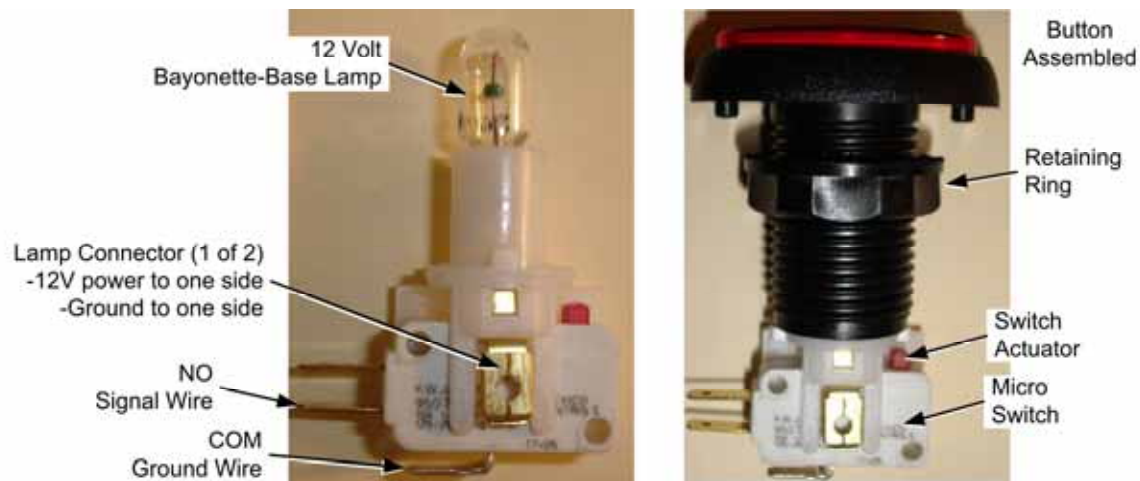

Figure 24. Start Button Assembly

Wells-Gardner® Monitor Replacement

Perform the steps that follow to remove the monitor from the cabinet for service or replacement. Be sure to follow all safety precautions while working with a monitor.

Tip: When removing the monitor from the cabinet, it is always best to have two people to support the weight of the monitor.

1. Turn the cabinet OFF and disconnect the AC power cord.
2. Disconnect all cables that connect the monitor to the cabinet, typically the following:
 - VGA Video cable from the back of the Monitor.
 - Power cable that connects to the monitor chassis PCB, located on your left as you face the monitor rear.
 - **Green** ground wire from the monitor frame on some models.
3. Remove the monitor remote control board from inside the coin door. Coil this cable and tie it to the monitor to prevent it catching while the monitor is being removed.
4. Inspect the disconnected cables and monitor frame to make sure that there are no wire ties holding the monitor to the cabinet.
5. Remove the retaining brackets from above and below the monitor. The upper bracket is secured with three Torx security screws, the lower bracket with four screws (two near each end).

6. Remove the glass display shield and plastic monitor bezel.
7. Remove the four (4) 1/4-20 monitor mounting nuts, as shown in Figure 25.



Figure 25. Monitor Mounting Nut Locations



Components in the monitor chassis can be charged with a VERY HIGH VOLTAGE even when powered OFF.

The monitor is very heavy. Two-person lifting is advised.

8. Carefully remove the monitor through the front of the cabinet and set it in a safe place. Most of the weight of the monitor is in the CRT at the front of the monitor.
9. Reverse these steps to re-install the monitor. Always clean the front of the CRT and the glass display shield before re-installing.
10. After replacing a monitor, use the Monitor Calibration screens from **System Tests** in the Operator Menu to verify proper operation and adjust the monitor (see page 12).

Wells-Gardner® Monitor Chassis PCB Removal

You can replace the monitor chassis PCB if you have problems with just the PCB.



Caution: Only a certified technician should attempt to remove or service the Monitor PCB. GLOBAL VR assumes no responsibility for damage while removing the PCB.

To prevent electrostatic discharge (ESD) damage, handle PCBs by the edges only and use a grounding wrist strap or similar precaution.

1. Turn the cabinet OFF and disconnect the AC power cord.
2. As a precaution, discharge the second anode with a high-voltage probe or high-voltage resistant screwdriver connected to the monitor chassis frame with an 18 AWG wire.
3. Remove the four nuts that hold the monitor chassis to the monitor frame.
4. Remove the two 4/40 Jack nuts that hold the video signal PCB to the monitor frame. See Figure 26.



Figure 26. Removing the Monitor PCB Mounting Hardware

5. Disconnect the Chassis Neck PCB from the Chassis Tube Neck of the CRT by pulling back on the Chassis Neck PCB. You will need to slide the Chassis Neck PCB to the side to clear the Chassis Tube Neck.



DANGER: The Second Anode Lead (H.V. CRT Feed) can be charged with a VERY HIGH VOLTAGE even when powered OFF.

6. Disconnect the second anode lead that connects to the CRT just above the Chassis Tube. Be very careful as the second anode lead can be charged with a VERY HIGH VOLTAGE even when powered OFF. Pinch the gray rubber flange and slightly push in to un-hook the metal prongs that hold the second anode lead to the CRT, shown by the arrows in Figure 27.

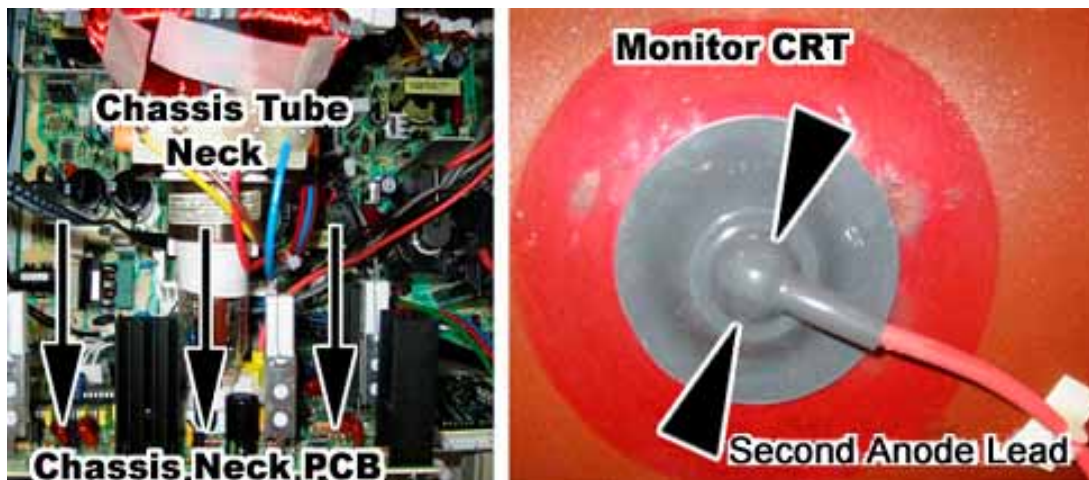

Figure 27. Disconnecting the Chassis Neck PCB and Second Anode Lead

7. Refer to Figure 28 to disconnect the next three cables:
 - a. Disconnect the CRT 2-wire ground cable that connects to the Chassis Monitor PCB (Item 1 in Figure 28).
 - b. Disconnect the CRT 2-wire ground cable that connects to the Chassis Neck PCB (Item 2 in Figure 28).

- c. Disconnect the Color and Sync 4-wire cable that connects from the Chassis Tube Neck to the Monitor chassis PCB (Item 3 below). Note the color alignment of this connector for installing the new monitor chassis PCB.



Figure 28. Monitor PCB Cables

8. You can now slide the monitor chassis PCB and other PCBs out the side of the monitor chassis as one unit.

Computer Replacement



The computer is serviced as one unit. YOU WILL VOID YOUR WARRANTY if you open the computer without direct authorization from the GLOBAL VR technical support staff.

Shipping the computer without enough padding can VOID THE WARRANTY if the computer is visibly damaged from shipping.

Disconnect the DVI-to-VGA adapter from the DVI port before shipping the computer. Leaving the adapter connected can cause damage to the video card.

Perform the following steps to remove the computer from the cabinet:

1. Disconnect all of the cables and the DVI-to-VGA Adapter from the computer.
2. Remove the Game Dongle and keep it with your cabinet. Do not ship the game dongle with the computer.
3. Note the position of the computer for re-installation. Open the buckle on the strap that secures the computer in place and carefully remove the computer from the cabinet.
4. Reverse these steps to replace the computer. Make sure that the computer air vents are not blocked. There is an air vent under the bottom front panel of the computer that is easily blocked by padding or debris.

When shipping the computer, always use plenty of padding and protection. GLOBAL VR recommends shipping the computer in a box with three inches of foam padding on all sides.

Coin Mech Replacement

Perform the following steps to remove the coin mech. You can replace the coin mech with any standard arcade coin mech.

1. Unscrew the thumbscrews on the latches as shown by the arrows in step 1 of the figure below.
2. Slide the latches apart from each other and remove the Coin Mech as shown in steps 2 and 3.
3. Reverse these steps to re-install a coin mech. It is important to verify the operation of the newly installed coin mech with both good and bad coins.

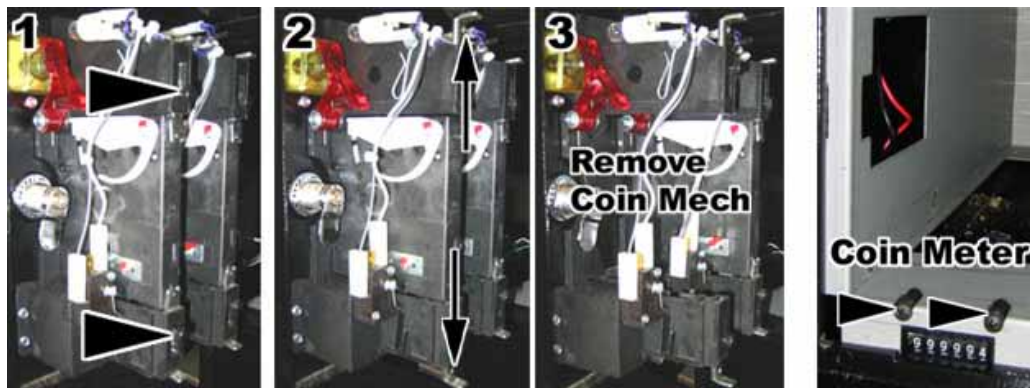

Figure 29. Servicing the Coin Mech and Coin Meter

Coin Meter Replacement

The coin meter is located in the bottom left-hand corner of the coin vault. It receives power via the GVRI/O PCB. If the coin meter stops working, first check the 5A fuse on the GVRI/O PCB and replace it if blown. Perform the following steps to replace the coin meter:

1. Turn the cabinet OFF and disconnect the AC power cord.
2. Remove the two Phillips screws securing the coin meter to the cabinet and remove the coin meter.
3. Cut the two wires from the coin meter and strip the ends of the wires to attach the new meter.
4. Use two butt splices to connect the wires to the new coin meter.
5. Secure the new coin meter with the two screws removed previously.

Power Distribution Service

AC Power Plate

The AC power plate provides the external AC power connection. An AC EMI Filter in the power plate removes electrical noise that can cause interference with the hardware inside the cabinet.

AC power from the power plate is connected to a 7-outlet AC power strip/surge suppressor in the cabinet.

Caution: The cabinet must be connected to a secure ground to function properly.

Ground wires from system components must be securely connected to the ground lug on the power plate, as shown below and in Figure 37 on page 52. Components must **not** be grounded to the power plate mounting bolts.

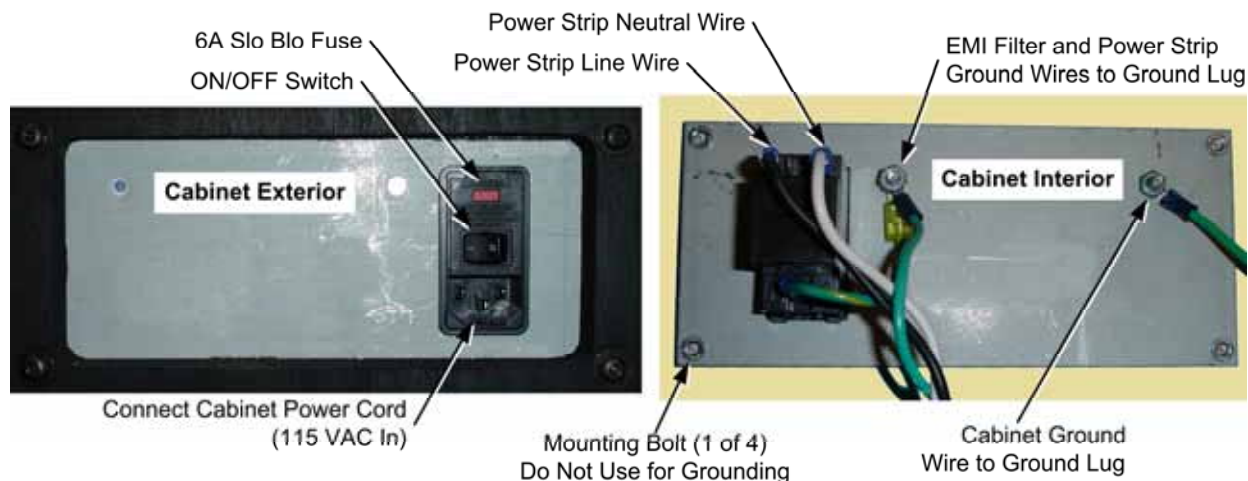

Figure 30. AC Power Plate (Shown Without Labels)

AC Power Strip Replacement

The AC power strip provides power to all of the components in the cabinet. If the cabinet has no power, check the 6A Slo Blo fuse in the power plate (see Figure 30) and replace if blown. Perform the following steps to replace the power strip:

1. Turn the cabinet OFF and disconnect the AC power cord.
2. Disconnect all components from the power strip.
3. Disconnect the power strip from the AC power plate terminals shown in Figure 30.
4. Remove the power strip; it is held in place with Velcro®.
5. Replace the power strip with an appropriate unit from GLOBAL VR (part # 49-0963-40). Do not attempt to use a different power strip. Be sure to connect each wire to the correct terminal (See Power Distribution Diagram on page 52.)

Caution: Be sure to connect each wire to the correct terminal. The ground wire must be securely connected to the ground lug on the power plate or the game will not function properly.

DC Power Supply Replacement

The DC power supply provides +24-volt power to the gun coils, and +12-volt power to the cold-cathode lighting, ventilation fan, and GVRI/O PCB. Perform the following steps to replace the DC power supply:

1. Turn the cabinet OFF and disconnect the AC power cord.
2. Make sure that all wires connected to the DC power supply are properly labeled for easy re-assembly, and then disconnect the wires from the terminals on the DC power supply.
3. Remove the four (4) screws that secure the power supply to the cabinet.
4. Reverse these steps to install the new power supply. Adjust the +5V output to 5.4V **before** connecting the power supply to the cabinet harnesses (use 5.2V if the power supply is

connected). If the voltage is too high it will damage electronic components. If it is too low, the game will not work properly.

5. Be sure to connect the wires to the correct terminals. Refer to Figure 37 on page 52 for a diagram.

Marquee Florescent Light Service

The marquee is lit by a florescent fixture. To gain access to the marquee fixture, remove the three (3) wood screws and five (5) nuts with washers from the back of the marquee, and then remove the marquee front with the artwork and clear plastic.

Replace the florescent tube with another 18" florescent tube.

To remove the fixture, disconnect the cabinet from AC power. Disconnect the AC power cord from the fixture. Remove the two Phillips screws that secure the fixture to the cabinet and remove the fixture. Replace the fixture with part # 49-1001-00.

Cold-Cathode Florescent Light Service

The cold-cathode florescent lighting is used for the "Mission Objective" instruction panel, and to add dramatic lighting effects to the cabinet.

Note: If both lights in a set fail, make sure the power connector is firmly attached to the power inverter. Connect the lights to another power inverter to test them. Replace the power inverter if faulty; it is held in place with Velcro and/or cable ties.

Refer to the table below if you need to replace a cold-cathode tube or inverter.

Light Location	Size & Qty	Changing Tube(s)	Inverter Location
Instruction Panel	Two 6" White Tubes	Remove the four (4) screws that secure the instruction panel in place.	Behind Instruction Panel
Kick Panel	One 12" White Tube	Remove the four (4) screws that secure the clear plastic plate above the kick panel.	Cabinet Floor
Area Below Guns	Two 6" Blue Tubes, One Below Each Gun	Remove the four (4) screws that secure the metal base plate below the gun.	Behind Instruction Panel
Speakers	One 12" Blue Tube	Remove the four (4) Torx screws that secure the speaker grill to access the tubes. Remove the back door to access the inverter.	Inside Cabinet on Side Wall

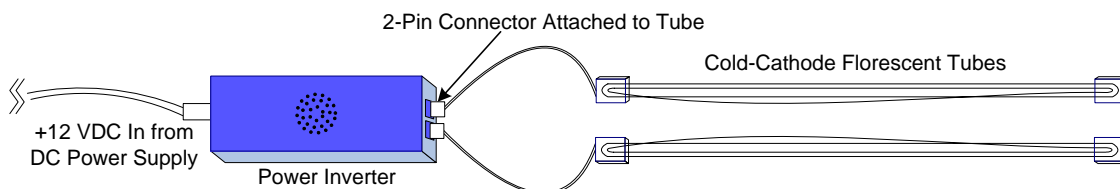

Figure 31. Cold-Cathode Light Detail

Setting the Computer BIOS (CMOS)

This procedure applies only to systems with the Intel 915GAG Motherboard.

Note: In the BIOS screens, use the left and right arrow keys (→←) to move between the menus listed at the top of the screen, and the up and down arrow keys (↑↓) to move up and down between menu items, and to change settings for selected items.

1. Press the **F2** key during boot. The BIOS Setup Utility Main Menu will appear.

2. Use the left and right arrow keys (→←) to select the **Exit** menu.

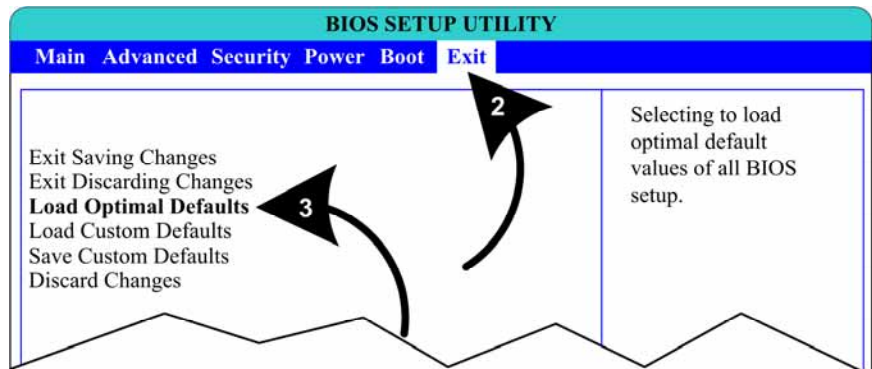

3. Use the up and down arrow keys (↑↓) to select **Load Optimal Defaults**, and press **Enter**. A confirmation box will appear. With **Ok** selected, press **Enter**.

4. Use the left and right arrow keys (→←) to select the **Boot** menu.

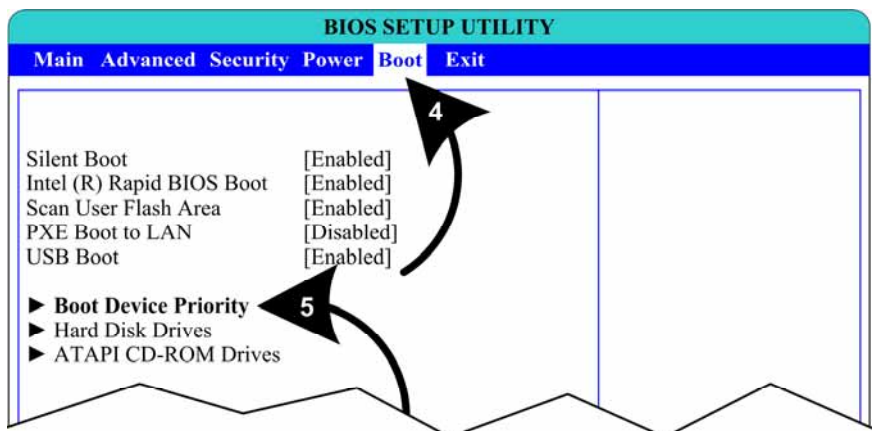

5. Use the up and down arrow keys (↑↓) to select **Boot Device Priority**, and press **Enter**. A device list will appear.

6. Use the up and down arrow keys (↑↓) to select **1st Boot Device**, and press **Enter**. A pop-up window will appear. Use the up and down arrow keys (↑↓) to select the **CD-ROM** drive, and press **Enter**. The hard drive will automatically be set as the 2nd Boot Device. Press the **Esc** key to exit from the submenu.

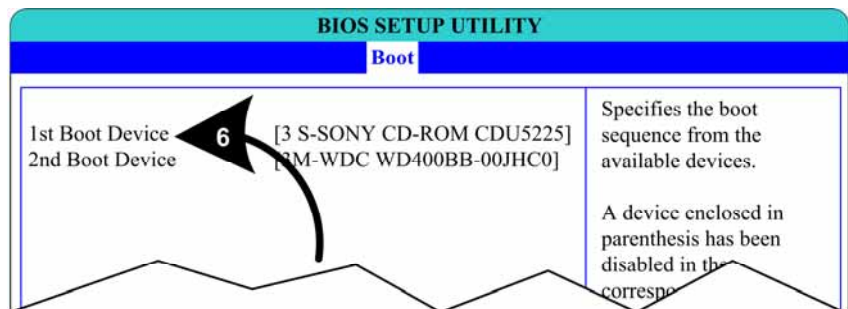

7. Use the left and right arrow keys (→←) to select the **Power** menu.
8. Use the up and down arrow keys (↑↓) to select **After Power Failure**, and press **Enter**. A pop-up window will appear. Use the up and down arrow keys (↑↓) to select **Power On**, and press **Enter**.

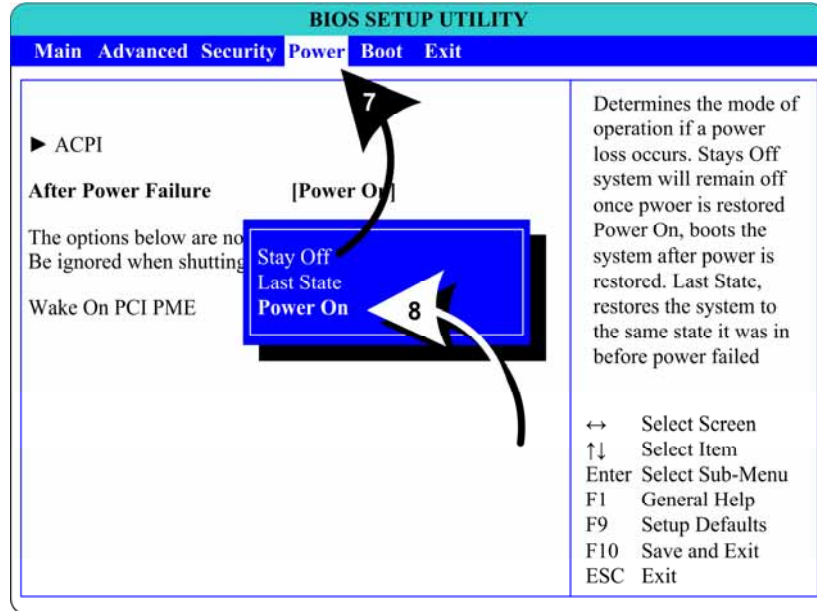

9. Use the left and right arrow keys (→←) to select the **Advanced** menu.

10. Use the up and down arrow keys (↑↓) to select **Floppy Configuration**, and press **Enter**. The **Floppy Configuration** menu will appear. Use the up and down arrow keys (↑↓) to select **Diskette Controller**, and press **Enter**. Use the up and down arrow keys (↑↓) set the Diskette Controller to **Disabled**, and press **Enter**. Press the **Esc** key to exit from the submenu.

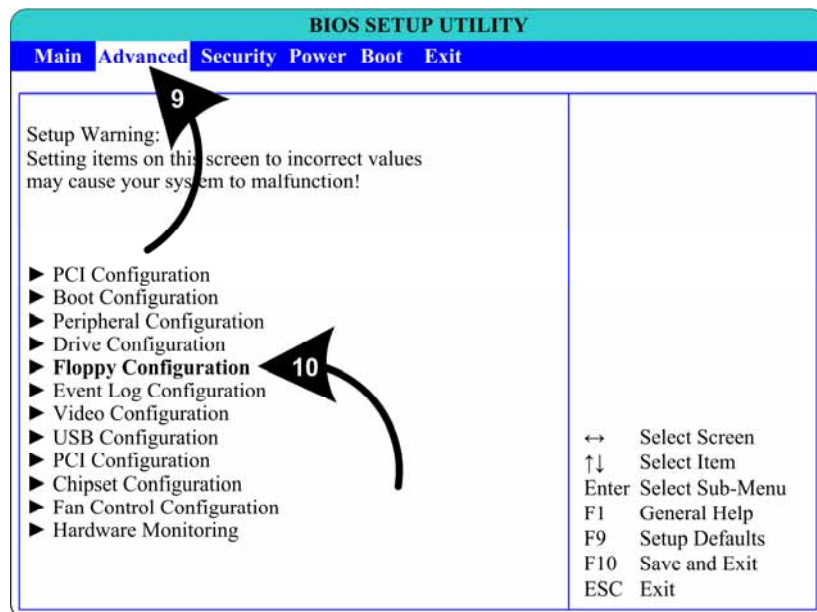

11. Now that all settings are correct, press **F10**. The following prompt will appear:

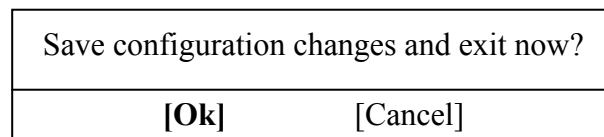

12. Make sure **Ok** is selected (use the arrow keys to select if necessary) and press **Enter**.

Chapter 7 — Replacement Parts

If you need replacement parts, please reference these part numbers when contacting GLOBAL VR technical support or your distributor.

Documents and Software

Part Number	Qty	Item Description
040-0120-01	1	System Manual
040-0121-01	1	Software Restore Guide
050-0089-01*	1	System Recovery CD
050-0099-01*	1	Game Install CD

*Part numbers may change due to software revisions.

Cables

Part Number	Qty	Item Description
115-0008-01	1	Power Cord for DC Power Supply
115-0049-01	1	Power Plate ground cable, 3.5"
115-0095-01	1	Coin Door Harness
115-0096-01	1	Marine 1 & 2 Start Button Harness
115-0097-01	2	Gun Power Cable with Fuses
115-0098-01	1	12V Lights Power Cable
115-0099-01	1	Ground wire, Gun to Coin Vault
115-0100-01	1	Speaker Harness
80-0213-00	1	Cabinet Power Cord, 6'
96-0539-00	1	Stereo Cable, 3.5mm, 6'
GLO-PWRCORD	1	Cable PGA LIGHT POWER CORD
USB-AB06MM	1	USB Cable, 6'
USB-EXT-6	2	USB Extension Cable, 6', USB 2.0, A Plug/A Jack

Cabinet Functional Components

Part Number	Qty	Item Description
WGM2794-U0FS53R	1	Monitor, Wells-Gardner 27" Flat Screen
990-0013-01	1	GVRI/O Mini PCB
Q-250D	1	DC Power Supply, 250W, 5/12/24VDC
CCFL2BU	1	Cold Cathode Light Kit, Dual 12" Blue (Speaker Lighting)
CCFL2W	1	Cold Cathode Light Kit, Dual 12", White (Kick Panel Lighting)
CCFL62BU	1	Cold Cathode Light Kit, Dual 6", Blue (Under Control Panel)
CCFL62W	1	Cold Cathode Light Kit, Dual 6", White (Instruction Panel)
CCM1600-ND	1	Power Entry Module with EMI Filter, Power Plate
37117-01	1	Power Plate
49-0963-40	1	7-Outlet Power Strip, Surge Protector, 15 Amps, 1500 Joules
49-1001-00	1	Florescent Light Fixture, 18"

Part Number	Qty	Item Description
5.25 SPEAKER PAIR	1	5.25" Speakers, Pair
59-8654-822H2205	1	Marine 2 Start Button, Blue
59-8654-833H2204	1	Marine 1 Start Button, Green
60039-00	1	Computer Mounting Strap
12V-FAN-QCA	1	12 VDC Cabinet Fan, with Power Cord

Computer

Part Number	Qty	Item Description
45067-00	1	System Computer Assembly
315-256M400-DDR	2	Memory, 512MB PC3200 DDR400, 32 x 8
290-915GAGL-INT	1	Motherboard, Intel 915GAGL
CDU5225-B2S	1	CD-ROM Drive, IDE
JM80547PG0802MM	1	CPU, P4, 3.0GHZ, 800 MHz
FAN-LGA775	1	CPU Fan, Intel P4 LGA775
VIDEO-PX6600-256	1	Video Card, PCI Express GeForce 6600, 256 MB
300-40GB3.5-ATA	1	Hard Drive, ATA 100, 40 GB
USB-KQRTG-HL	1	USB Game Dongle

Gun Parts

Also see pages 42 and 43.

Part Number	Qty per Gun	Item Description
26090-01	1	Gun Housing, Left
26090-02	1	Gun Housing, Right
96-0799-00	1	Gun Assembly
METL6R	1	LED Light Tube, Red
990-0012-01	1	Gun PCB

Cabinet Artwork

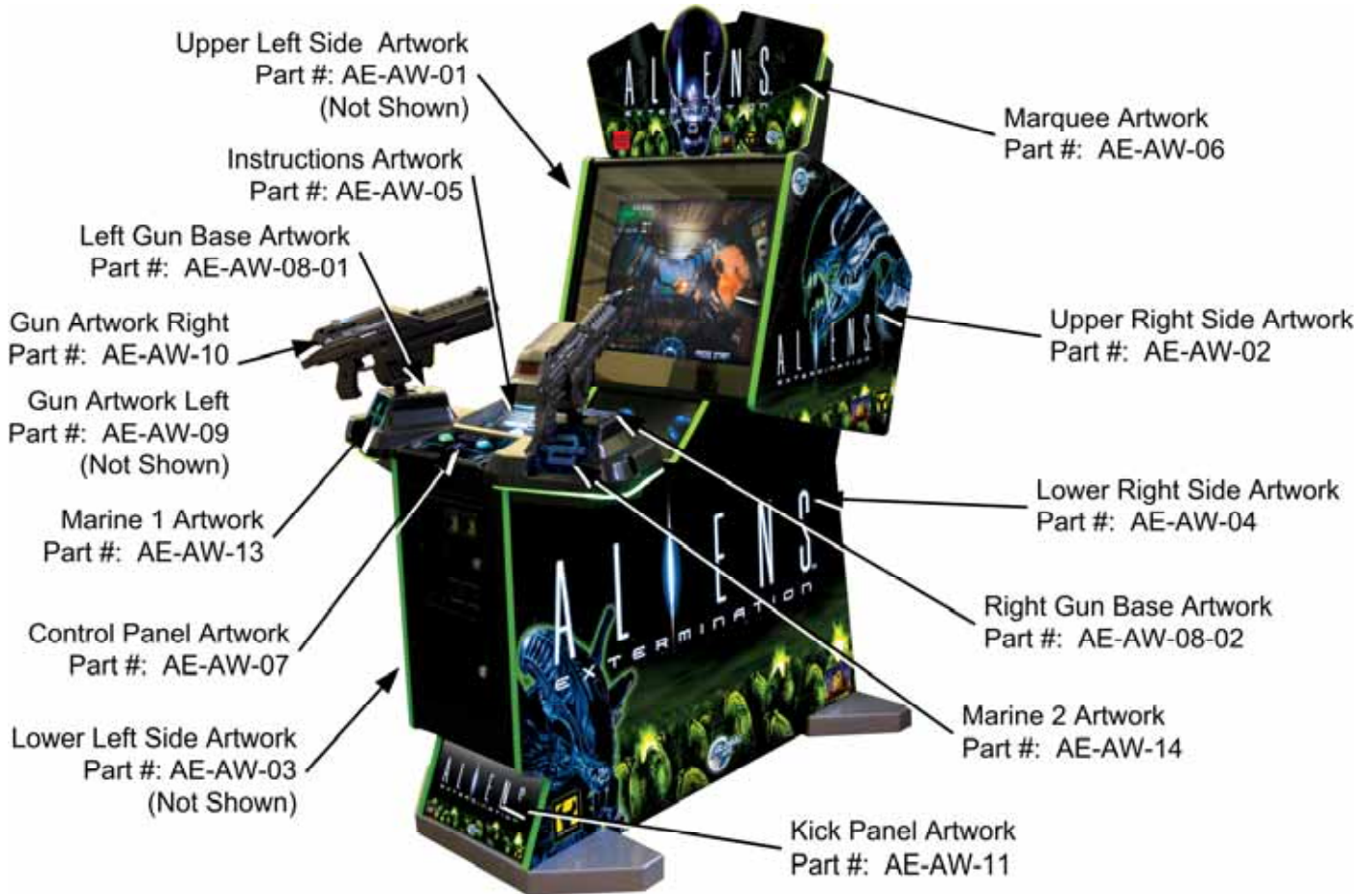

Figure 32. Cabinet Artwork

Gun Exploded-View Parts

Ref #	Qty	Part Number	Item Description
1	1	96-4901-00	BOTTOM PLATE F/WMS ANALOG GUN
2	1	96-4937-00	BRACKET F/SWIVEL BASE ASSY.
3	1	96-4934-00	BRACKET PIVOT BOX & SHAFT ASSY.
4	1	96-4902-00	BRACKET HANDLE WELDED
5	1	96-4915-00	BRKT COIL MTG
6	1	96-4923-00	SHAFT 5/8 DIA.
7	1	96-4908-00	DISC PLASTIC WASHER
8	1	96-4907-00	GEAR SEGMENT W/HUB
9	1	96-4960-00	SPACER SEGMENT GEAR
10	1	43-0232-00	NUT, HEX NYLOCK 1/2-20
11	1	43-0055-00	WASHER, FLAT 1/2 SAE
12	7	42-0082-00	NUT, KEPS 8-32
13	8	43-0252-00	SCREW, #8-32 x 3/8 HEX HEAD
14	1	43-0003-00	3/8 SAE FLAT WASHER ZNC PLTD
15	1	43-0092-00	NUT 3/8-16 NYLOCK
16	1	43-0280-00	HEX HEAD CAP SCREW 10-31 X 1-1/4
17	2	43-0037-00	LOCKWASHER, EXT #10
18	3	43-0253-00	NUT HEX 10-32 JAM NYLOCK ZINC PLATED
19	1	96-4900-00	COIL RETAINING BRACKET
20	1	96-4938-00	INSULATOR
21	1	96-4904-00	BRACKET POT MTG HORIZONTAL
22	1	96-4913-00	BRKT POT MTG VERTICAL
23	1	96-4936-00	PLUNGER F/SOLENOID
24	1	96-4931-00	SPRING COMPRESSION
25	1	96-4971-00	BUMPER SOLENOID STOP
26	1	96-4921-00	GEAR SEGMENT HUBLESS
27	2	43-6972-00	SPACER F/BUMPER
28	1	43-0188-00	SCREW, #8-32 x 3/8" HEX WASHER HD
29	2	43-0254-00	SCREW 10-32 X 2.25 HEX HD ZINC
30	4	96-4920-00	BEARING .625 BORE
31	2	96-4917-00	GEAR 32DP 16T .25" BORE .5" L.
32	1	96-4970-00	REAR BUMPER PAD
33	1	96-4911-00	BUMPER 3/4 DIA.
34	2	96-4919-00	BUMPER 5/8 DIA. VERTICAL
35	1	96-4935-00	COIL WITH TUBING
36	2	96-4973-00	PAD ADHESIVE FOAM TAPE
37	2	96-4916-00	LONG LIFE POT W/NUT & WSHR 5K
38	1	43-0223-00	E-RING 3/8 DIA SHAFT
39	1	FI-0229-GVR	ALIEN GUN HALF LEFT FI FROM GVR
40	1	FI-0230-GVR	ALIEN GUN HALF RIGHT FI FROM GVR
41	1	95-4142-00	SWITCH ASSY BALL DETECT
42	1	54V-0004-20	IPB SM CIR RED RED CAP 14V73 VLT LAMP ASSY
43	1	96-2515-06	TRIGGER BLACK NEW STYLE
44	1	96-0005-00	SPRING, TRIGGER RETURN
45	1	57-2000-50	VLT BUTTON REC,RED W/6V LAMP
46	11	4008-01100-16	SCREW 8-32 X 1" BH TORX
47	8	43-1130-00	SCREW 8-32 X 1/4"BUTTON HD TORX TAMP BLK OX.
48	14	43-0211-00	NUT, 8-32 NYLOK
49	1	43-2318-00	SCREW 8-32 X 5/8 BHMS TORX
50	2	43-2317-00	SCREW 8-32 X 7/8 BHMS TORX
51	2	43-0172 00	SCREW, #2 X 1/2 TYPE B. PPH

Chapter 8 — Troubleshooting

Video Troubleshooting

Problem	Cause	Possible Solution
No picture on monitor	Power problem	Check the AC power connection to the monitor. You can verify that the monitor has power by looking for a small glow in the neck of the CRT.
	Loose or faulty video cable	Verify that the video cable is firmly connected from the monitor to the video card in the computer. While the monitor is powered ON, disconnect the video cable. You should see a message on-screen saying <i>No Signal</i> if the monitor is working. Check the video cable and make sure it is not pinched or frayed.
	Loose or faulty video card	When the computer boots up, it performs a PC self-diagnostic test. If you hear 3 beeps from the computer, this indicates a problem with the video card. If the video card is faulty, contact Technical Support. If instructed by Tech Support, open the computer and make sure the video card is seated properly in the motherboard. Power on and make sure the fan on the card is spinning fast.
	Faulty monitor chassis PCB	Verify that the fuses on the monitor chassis PCB are good and that all connections are secure. If you need to replace the chassis, see the instructions on page 31.
No picture or corrupted picture on monitor	Video card connection problem	Disconnect and then reconnect the DVI-to-VGA Adapter on the back of the computer. Try the following if directed by Technical Support: <ul style="list-style-type: none"> • Reseat the video card in the motherboard. • Check the power connector to the video card inside the computer. Make sure it is connected properly and is not connected backwards.
Picture is dim or faded	Gamma needs adjustment	Use the monitor remote control board to adjust the brightness and contrast settings. Adjust the monitor gamma setting from System Adjustments in the Operator Menu to increase overall brightness.
Picture color is poor	Color needs adjustment	Use the monitor remote control board to adjust the red, green, and blue color settings. Use the Video Screen Tests in System Tests in the Operator Menu to aid with color adjustments.
Picture geometry is misaligned	Geometry needs adjustment	Use the monitor remote control board to adjust the picture height and width, and other geometry. Use the Screen Size Adjustment screen from Video Screen Tests in System Tests in the Operator Menu to aid with adjustments.

Problem	Cause	Possible Solution
No video and no audio (Note: It may take nearly 2 minutes to boot and start the game)	No power to computer	Verify the computer is ON by the LED on the front of the computer. Verify the line voltage switch on the back of the computer is set to the correct voltage for your area, 115V or 230V. Make sure the AC power cord is firmly connected to the computer and the power strip and the power strip LED is on. Turn off the power strip, wait 20 seconds, and then turn it back on to reboot the computer. If the computer does not power on, make sure the On/Off switch on the back of the computer is in the On (I) position. Make sure that <i>After Power Failure</i> in the BIOS is set to <i>Power On</i> (see page 37).
	Corrupted software	Reload the software from the CDs. If you continue to have problems, you may have a faulty hard drive.
	Faulty hard drive	If you continue to have problems after you reload the software, you may have a faulty hard drive. Contact Technical Support.
Poor picture	Monitor connected to wrong port	The monitor must be connected to the DVI Video port on the video card, using a VGA to DVI adapter. Do not use the VGA port (see Figure 38 on page 53).

Audio Troubleshooting

Problem	Cause	Possible Solution
No audio or Poor sound from one or more speakers	Volume set too low	Use the VOL UP button on the Operator Button Panel (see Figure 5 on page 10) to raise the volume.
	Faulty wiring	Verify that all the wires are firmly connected to the speakers, GVRI/O PCB, and green computer audio port. Verify that each wire is connected to the correct port and no wires are frayed or improperly shorting to ground.
	Blown speakers	Remove the grill and inspect each speaker for visible damage. Run the Sound Test from System Tests in the Operator Menu to verify each speaker is working.
	Reversed wires	A weak or low muffled sound is a sign of reversed speaker wires. Check for reversed wires on each speaker.
	Faulty GVRI/O PCB	To verify audio is working at the computer, connect stereo headphones to the green computer audio port.
No Audio & no buttons	GVRI/O PCB connected to faulty USB port	To test a USB port, turn off the game, disconnect the device from the port, and then connect the game dongle to the port. Reboot the game. A <i>No Dongle</i> message indicates the port is bad. If the game starts, the port is working. After the test, reconnect all devices to the correct USB ports and reboot. See Figure 38 on page 53 for more information. Important: Disconnect power before changing any USB connections.
Audio hum	Faulty power supply	A constant low hum in the speakers can be caused by a faulty power supply. This could be either the external DC power supply or the computer power supply.
	Open ground	Check all ground wires in the cabinet. Make sure AC wall outlet is properly grounded.

Button Troubleshooting

Problem	Cause	Possible Solution
Buttons do not work	Faulty micro switch	Replace the micro switch on the button and re-test. Verify that the wires are connected to the correct spades on the micro switch (see Figure 24 on page 30).
	Faulty wiring	Disconnect the cabinet from AC power. Verify that all wires are firmly connected to each button and the GVRI/O PCB. Verify that no wires are frayed or improperly shorting to ground. Verify that wires are connected to the correct spades on the micro switches.
	Faulty GVRI/O PCB	Make sure that all connections to the GVRI/O PCB are secure. Replace PCB if faulty.
Buttons do not work & audio does not work	GVRI/O PCB connected to faulty USB port (Boot message may indicate GVRI/O not detected)	To test a USB port, turn off the game, disconnect the device from the port, and then connect the game dongle to the port. Reboot the game. A <i>No Dongle</i> message indicates the port is bad. If the game starts, the port is working. After the test, reconnect all devices to the correct USB ports and reboot. See Figure 38 on page 53 for more information. Important: Disconnect power before changing any USB connections.

Gun Troubleshooting

Caution: Disconnect cabinet AC power cord before making **any** connections to guns. Failure to do so may damage gun components.

Problem	Cause	Possible Solution
Gun(s) does not work or Message at boot indicates gun(s) was not detected	Faulty wiring	Verify that all wires are firmly connected and no wires are frayed or improperly shorting to ground. If using PCI USB ports, verify USB cables are connected to correct ports.
	Disconnected USB or DC power	Check all power and USB connections. If all gun lights are off, this indicates a problem with +12 VDC power.
	Blown fuse in gun power harness	Check the fuses (MDL 2A Slo Blo) in the gun power harness.
	Gun(s) connected to faulty USB port	To test a USB port, turn off the game, disconnect the device from the port, and then connect the game dongle to the port. Reboot the game. A <i>No Dongle</i> message indicates the port is bad. If the game starts, the port is working. After the test, reconnect all devices to the correct USB ports and reboot. See Figure 38 on page 53 for more information. Important: Disconnect power before changing any USB connections.
	Guns connected to wrong USB ports	If using the PCI USB ports, check the label above the ports on the computer. If you replace the PCI USB card, you may need to use different ports. See Figure 38 on page 53 for more information.
	Faulty power supply	Verify the external DC power supply is putting out the correct voltages.
A button or trigger does not work	Faulty micro switch or wiring	Check micro switch inside gun. Check wiring. Make sure no wires are pinched in the gun case.

Problem	Cause	Possible Solution
No force-feedback recoil in gun	Faulty DC power supply	Make sure the external DC power supply is putting out +24 VDC.
	Kicker turned off	Turn on the Kicker in the Gun Adjustments menu.
	Faulty coil	Check wiring inside gun. Replace coil if faulty.
Force-feedback recoil & LED flashes in the wrong gun or No gun crosshairs visible on screen	Gun wiring or setting is flipped, or each gun has a different gun board revision	From the Gun Adjustments screen in the Operator Menu, toggle the Gun Output Control and Gun Input Control between Normal and Flipped and see if this resolves the problem.
Gun does not aim properly or No gun crosshairs visible on screen	Gun out of Calibration	Calibrate the gun using Gun Test & Calibrate from System Tests in the Operator Menu.
	Faulty pot or gear	Check gun pots and gears (see <i>Gun Pot and Gear Service</i> on page 27).
No gun crosshairs visible in game play, but guns work fine in calibration test	One gun has flipped	This can be caused by a faulty PCI USB card or computer. Contact Tech Support for Assistance.
No lights on gun	Check +12 VDC power	Check wiring and make sure external DC power supply is putting out +12 VDC
Fuses blow	Pinched wires	Make sure no wires are pinched by the gun case.
	Faulty power supply	Test voltage output and replace power supply if faulty.
Ammo readout not working or looks strange	Faulty Gun PCB	Check all connections to the Gun PCB (it is powered by +5 VDC from the USB connection). Replace PCB if faulty.

Miscellaneous Troubleshooting

Problem	Cause	Possible Solution
No power	Power strip not plugged in or turned off	Make sure the power indicator light on the power strip is on. If it is off, make sure the connections to the AC power plate terminals are secure and the power strip ON/OFF switch is ON.
	Cabinet not connected or turned off	Make sure the AC power cord is firmly connected to the power plate and an active AC outlet, and the cabinet ON/OFF switch is ON.
	Blown fuse in power plate	Check the fuses in the power entry module in the power plate.

Problem	Cause	Possible Solution
Game dongle not found by system computer	Game dongle not connected	Connect the game dongle. Power the cabinet off and then on.
	Faulty game dongle or wrong dongle version	Make sure the dongle is connected properly. (USB dongles illuminate when recognized by the computer. Parallel dongles do not.) Contact Tech Support if you need to order a new dongle.
	Faulty port	If you try a different game dongle and reboot the game, but the dongle still is not recognized, contact Tech Support.
Cabinet gets very warm	Faulty ventilation fan	Verify that the ventilation fan is working. It is located under the vents at the top of the cabinet. Replace the fan if it is worn or spinning slowly. Make sure the fan is getting +12 VDC from the external DC power supply.
	Cabinet ventilation holes are blocked	Make sure you have proper clearance between the cabinet rear and the wall. Make sure the vent holes are clear of dust and debris and that air can flow freely.
Marquee lamp does not light or is intermittent	Faulty florescent tube	Check the florescent tube for darkened or cracked ends. Replace the florescent tube if it looks worn.
	Faulty florescent fixture	Verify the florescent tube pins make a good connection with the lamp fixture. Check the ballast for proper operation. Replace fixture if faulty.
Improper number of credits given when coins or bills are inserted	Incorrect setting in Operator Menu	Adjust settings from the Operator Menu.
	Faulty wiring	Disconnect the cabinet from AC power. Verify that all wires are firmly connected to the coin mech and bill validator, and ground wires are properly connected. Verify that no wires are frayed or improperly shorting to ground.
	Faulty coin mech	Verify the coin mech is not jammed. Make sure the coin mech is properly aligned and latched to the coin door. Repair or replace if faulty.
Coin meter does not work	Blown fuse(s) on GVRI/O PCB	Replace the 5 Amp fuse(s) on the GVRI/O PCB.

Chapter 9 — Diagrams and Schematics

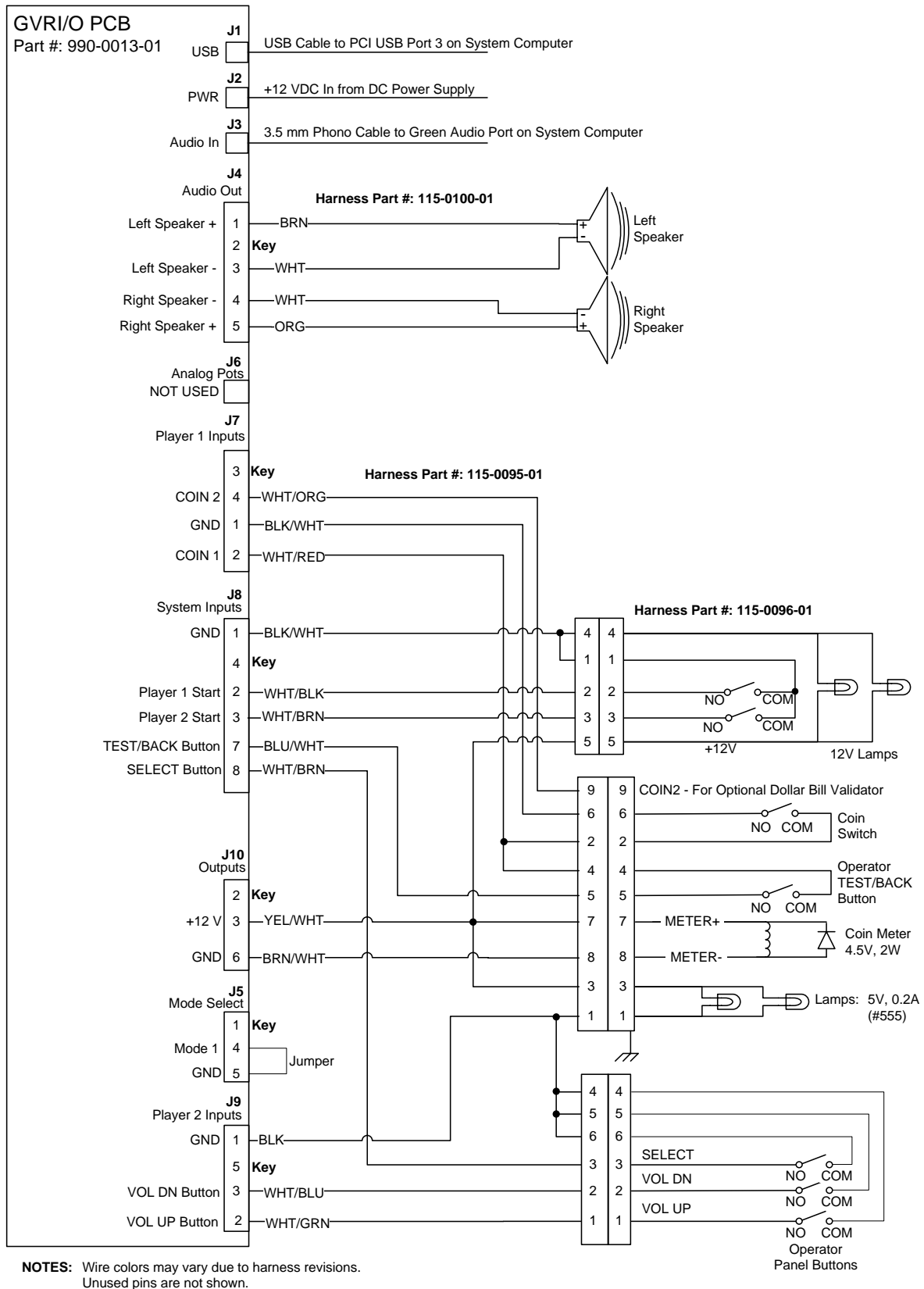
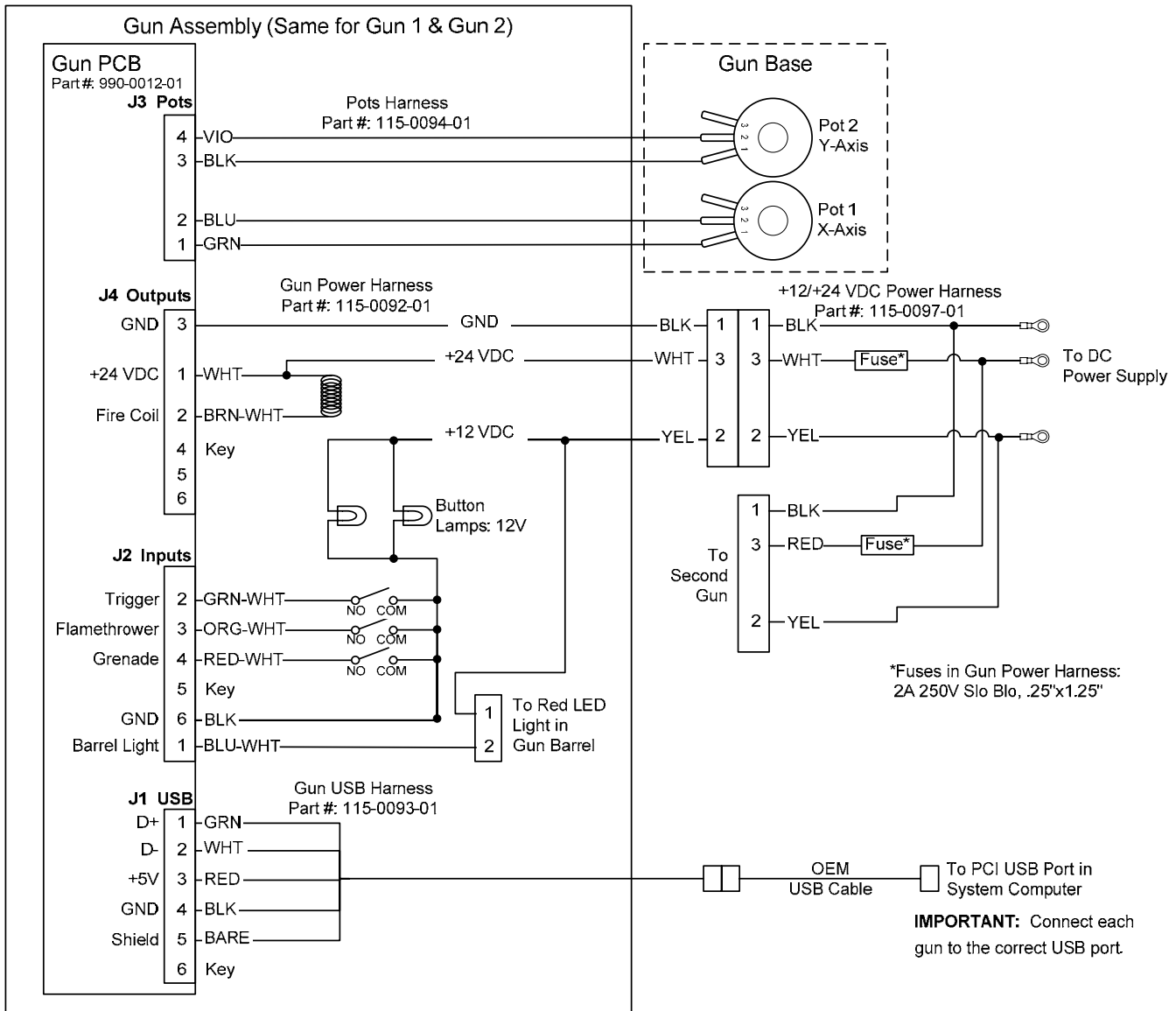

Figure 34. GVRI/O Wiring Diagram



NOTE: Wire colors may vary due to harness revisions.

Caution: Disconnect power before changing any USB connections or you will damage the PCBs.

Figure 35. Gun Wiring Diagram

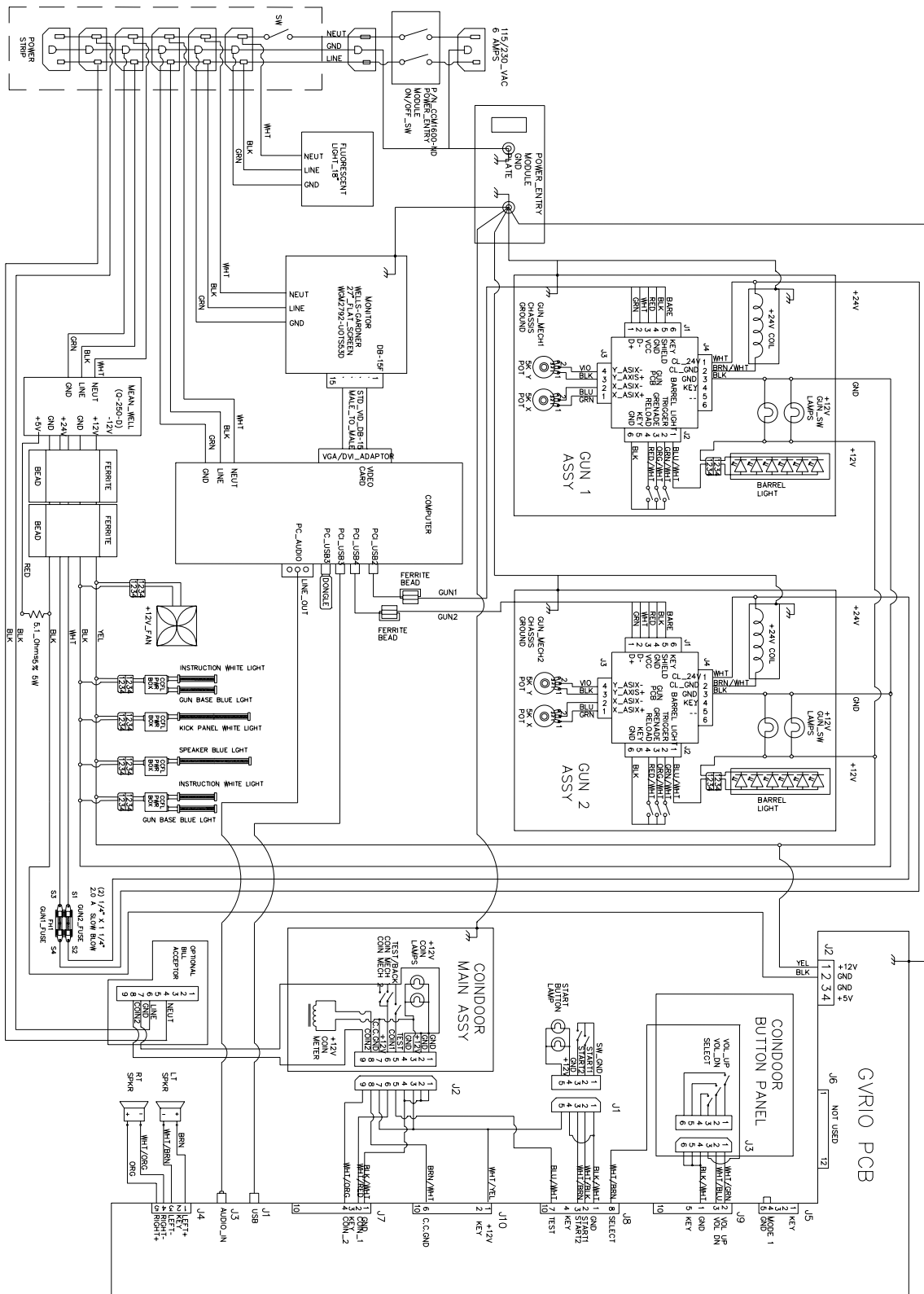

Figure 36. Overall Cabinet Wiring Diagram

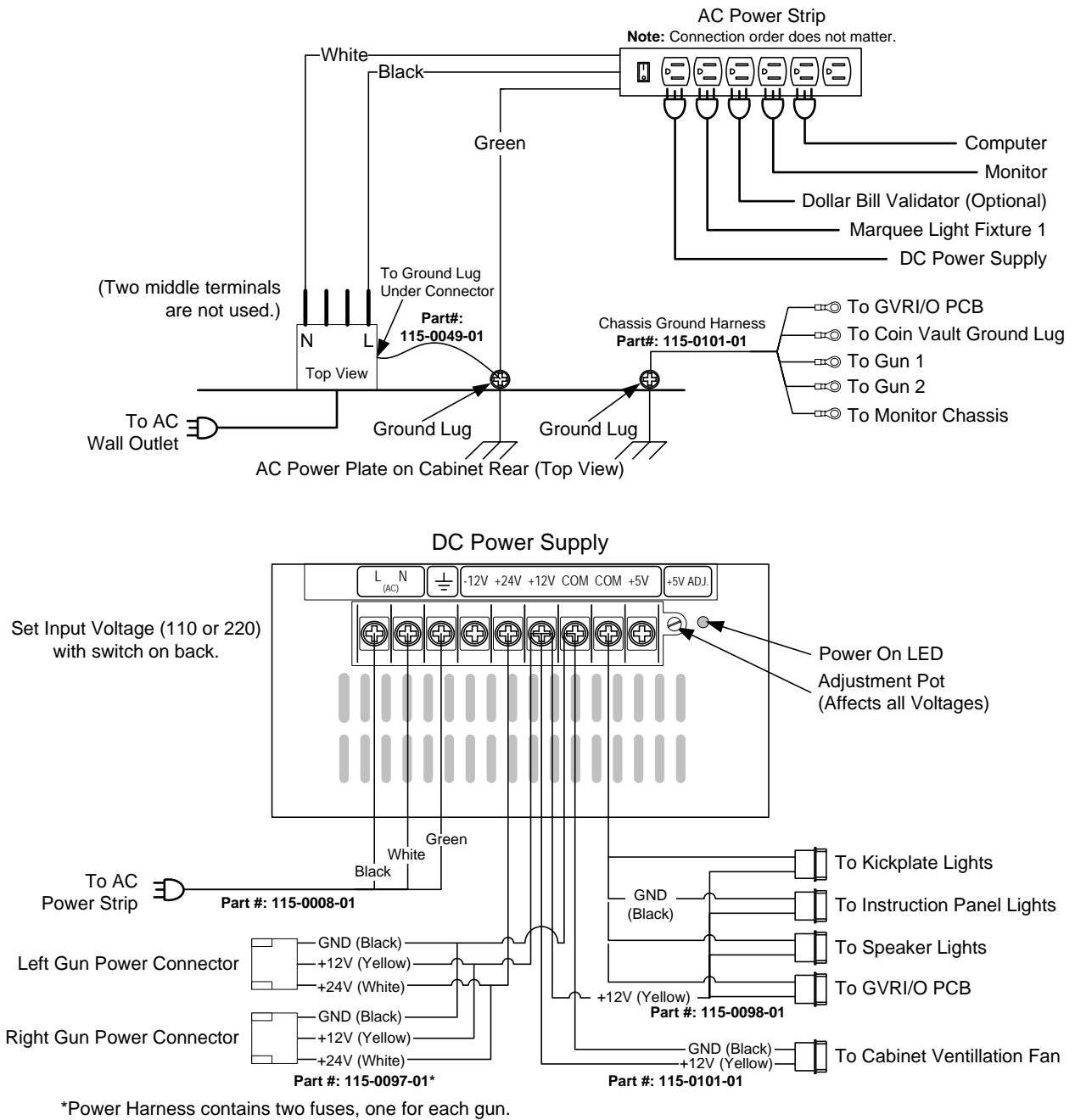
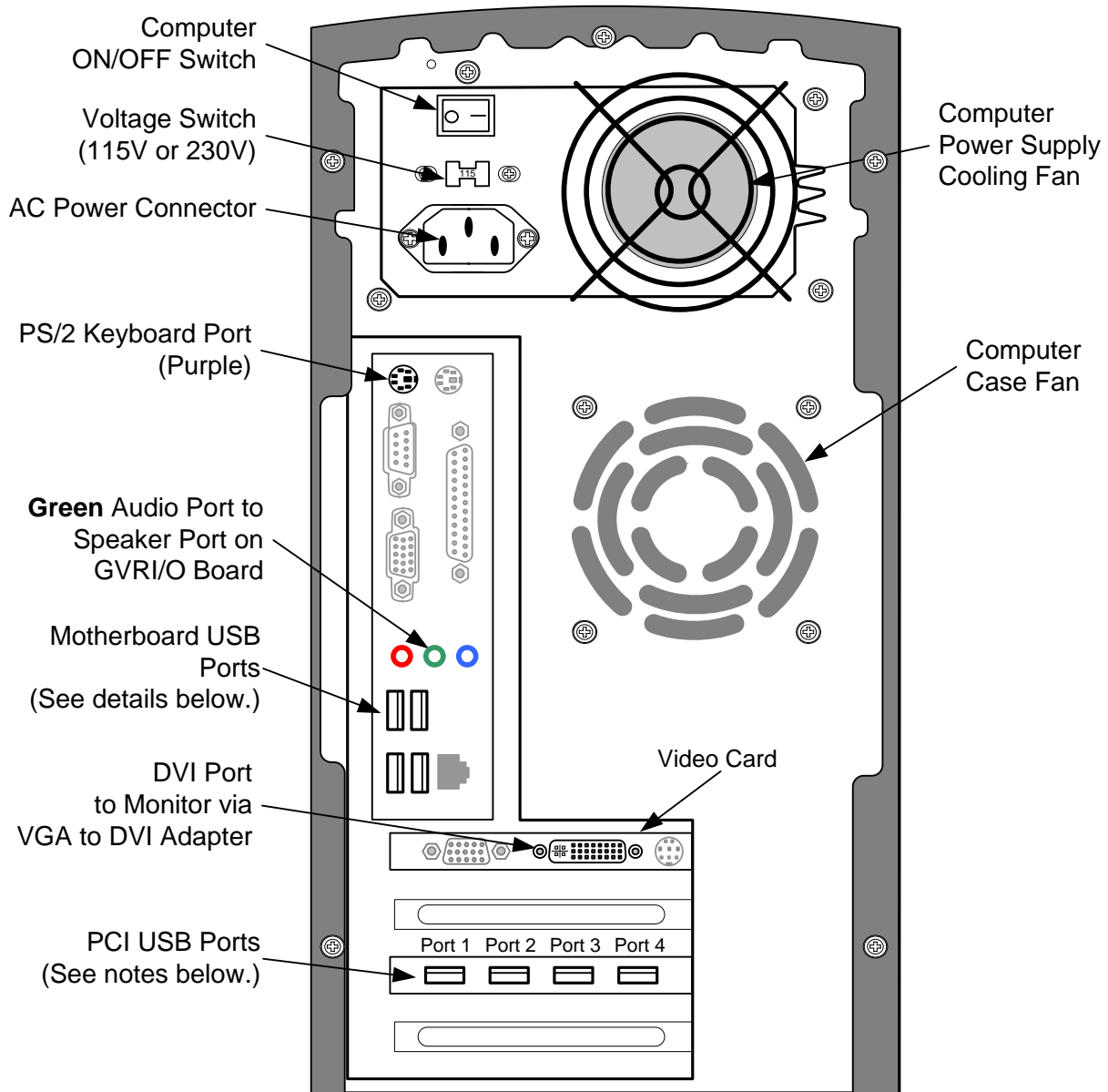

Figure 37. Power Distribution Diagram



Caution: Disconnect power before changing any USB connections or you will damage the PCBs.

Important: If using the PCI USB ports for Guns and GVRI/O PCB, you must use the ports specified on the labels above the ports. If you replace the PCI USB card, you may need to change the ports used. Current systems use one of the following configurations:

Port 1: Open, **Port 2:** Left Gun (Marine 1), **Port 3:** GVRI/O PCB, **Port 4:** Right Gun (Marine 2)

Port 1: Open, **Port 2:** GVRI/O PCB, **Port 3:** Left Gun (Marine 1), **Port 4:** Right Gun (Marine 2)



Figure 38. Computer Rear Panel Diagram

Warranty Service

If at some point you require warranty service, contact your authorized GLOBAL VR distributor.

Warranty Information

LIMITED WARRANTY

GLOBAL VR® warrants that its computer circuit boards, hard drives, power supplies, monitors, displays, controls, sensors, and mechanical structures are free from defects in materials and workmanship under normal use and service for a period of ninety (90) days from the date of shipment.

All software and accompanying documentation furnished with, or as part of the Product, is supplied "AS IS" with no warranty of any kind except where expressly provided otherwise in any documentation or license agreement furnished with the Product.

During the warranty period, GLOBAL VR® will, at no charge, repair the Product, provided:

- Purchaser believes that the Product is defective in material or workmanship and promptly notifies GLOBAL VR® in writing with an explanation of the claim;
- All claims for warranty service are made within the warranty period;
- Products are returned adequately packed and freight prepaid to GLOBAL VR®'s designated service center;
- GLOBAL VR®'s inspection or test of the Product verifies to GLOBAL VR®'s satisfaction that the alleged defect(s) existed and were not caused by accident, misuse, neglect, unauthorized or attempted repair or testing, unauthorized modification, incorrect installation, vandalism, failure to follow the maintenance schedule or procedures; or operation in out-of-specification environmental conditions.

GLOBAL VR® will return the repaired Product freight prepaid to the Purchaser. All freight costs associated with replacement of warranty parts after expiration of the original warranty period are the responsibility of the Purchaser. GLOBAL VR® is not obligated to provide the Purchaser with a substitute unit or on-site service during the warranty period or at any time. If after investigation GLOBAL VR® determines that the reported problem was not covered by the warranty, Purchaser shall pay GLOBAL VR® for the cost of investigating the problem at its then prevailing per incident billing rate. No repair or replacement of any Product or part therein shall extend the warranty period as to the entire Product. The warranty on the repaired part only shall be in effect for a period of ninety (90) days following the repair or replacement of that part or the remaining period of the Product parts warranty, whichever is greater.

Purchaser's exclusive remedy and GLOBAL VR®'s sole obligation is to supply or pay for all labor necessary to repair any Product found to be defective within the warranty period and to supply, at no extra charge, new or rebuilt replacements for defective parts. If repair or replacement fails to remedy the defect, then, and only in such event, shall GLOBAL VR® refund to Purchaser the purchase price for said Product. Purchaser's failure to make a claim as provided above or continued use of the Product shall constitute an unqualified acceptance of said Product and a waiver by Purchaser of all claims thereto.

IN NO EVENT SHALL GLOBAL VR® BE LIABLE FOR LOSS OF PROFITS, LOSS OF USE, INCIDENTAL OR CONSEQUENTIAL DAMAGES RESULTING FROM OPERATION OF THE GAME IN ANY CONDITION. GLOBAL VR® SHALL NOT BE RESPONSIBLE FOR THE SUITABILITY, PERFORMANCE, OR SAFETY OF ANY NON- GLOBAL VR® PART OR ANY MODIFICATION PERFORMED BY ANY PRODUCT DISTRIBUTOR UNLESS SUCH WORK IS EXPRESSLY AUTHORIZED IN ADVANCE BY GLOBAL VR®.

THIS WARRANTY IS IN LIEU OF ALL OTHER EXPRESSED OR IMPLIED WARRANTIES, INCLUDING THE IMPLIED WARRANTIES OF MERCHANTABILITY AND FITNESS FOR A PARTICULAR PURPOSE, AND ALL OTHER OBLIGATIONS OR LIABILITIES ON GLOBAL VR®'S PART, EXCEPT FOR ANY EXPRESS WARRANTY SET FORTH IN A WRITTEN CONTRACT BETWEEN GLOBAL VR® AND PURCHASER CONTAINING SPECIFIC TERMS WHICH SUPERSEDE THE TERMS HEREIN. THIS WARRANTY DOES NOT AUTHORIZE ANY OTHER PERSON TO ASSUME OTHER LIABILITIES, IF ANY, CONNECTED WITH THE SALE OF PRODUCTS BY GLOBAL VR®.

Technical Support

Service & Parts

Hours: 7:00AM–5:00PM Pacific Time, Monday–Friday

Phone: 408.597.3435

Fax: 408.597.3437

E-mail: techsupport@globalvr.com

Website: <http://service.globalvr.com>

Extended Service Hours: Monday–Friday 5pm—Midnight
Saturday & Sunday 7:00am—Midnight Pacific Time

Free telephone, e-mail, and online support are provided for systems during the warranty period. GLOBAL VR Technical Support can help you troubleshoot problems and diagnose defective parts. We can also answer questions about the operation of your game.

When you contact Technical Support, please provide the information listed below, as applicable, to assist the Technical Support representative in solving your problem quickly. For your convenience, space is provided to write important numbers.

- Cabinet Serial Number: _____
- Version and Build from Operator Menu: _____
- Proof of Purchase information
- Your mailing address and telephone number
- A summary of the question or a detailed description of the problem
- Specific error message
- Date of latest install or upgrade
- Any changes made to the system
- For game-play issues, the level and number of players

To comment on this document, please e-mail: techpubs@globalvr.com