

# **701/702**

## *Documenting Process Calibrator*

*Users Manual*

November 1994, Rev. 4, 3/98

© 1994, 1995, 1996, 1998 Fluke Corporation. All rights reserved. Printed in U.S.A.

All product names are trademarks of their respective companies.

Visit the Fluke website at: [www.fluke.com](http://www.fluke.com)

**FLUKE**



# ***Table of Contents***

<b>Title</b>	<b>Page</b>
Introduction .....	1
Standard Equipment .....	4
Safety Information .....	10
Getting Acquainted with Your Calibrator .....	12
Input and Output Jacks .....	12
Keys .....	14
Display .....	17
Setting Up the Calibrator .....	17
Using the Strap and Bail .....	17
Charging the Battery .....	20
Battery Life .....	21
Automatically Saving Battery Life.....	23
Using the Optional Battery Eliminator .....	23

Selecting the Display Language .....	24
Adjusting the Display Contrast.....	24
Setting Up the Date and Time Display.....	24
Using the Backlight .....	25
Personalizing the Calibrator.....	26
Using Measure Mode .....	27
Measurement Ranges.....	27
Measuring Electrical Parameters .....	28
Testing Continuity .....	30
Measuring Pressure.....	30
Measuring Temperature .....	33
Using Thermocouples.....	33
Using Resistance-Temperature Detectors (RTDs).....	36
Measurements in Percent of Scale .....	40
Damping Your Measurements .....	40
Using Source Mode.....	41
Sourcing Electrical Parameters.....	41
Simulating a 4 to 20 mA Transmitter.....	43
Providing Loop Power.....	45
Sourcing Pressure .....	47
Simulating Thermocouples .....	50
Simulating RTDs.....	52
Sourcing in Percent of Scale.....	54
Stepping and Ramping the Output Value .....	54
Stepping the Output.....	54

---

- Ramping the Output ..... 55
- Simultaneous Measure/Source ..... 59
- Calibrating a Process Instrument ..... 62
  - Generating “As Found” Test Data ..... 62
  - Adjusting the Transmitter ..... 66
  - “As Left” Test Run ..... 67
- Memory Operations ..... 68
  - Saving Results ..... 68
  - Reviewing Memory..... 69
  - Data Logging (Model 702 Only) ..... 70
  - Observing Min and Max Measurements ..... 72
  - Viewing the Task List (Model 702 Only)..... 72
  - Clearing Memory..... 73
- Quick Guide to Applications ..... 73
- Communicating with a PC (Model 702 Only)..... 83
- Maintenance ..... 83
  - Replacing the Battery Pack..... 83
  - Internal Lithium Backup Battery ..... 83
  - Cleaning the Calibrator ..... 83
  - Calibration Data ..... 84
  - Service Center Calibration or Repair ..... 84
  - Replacement Parts..... 84
- Specifications ..... 86
  - DC Voltage Measurement..... 87
  - AC Voltage Measurement ..... 88
  - DC Current Measurement..... 89

Resistance Measurement .....	89
Continuity Testing .....	90
Frequency Measurement .....	90
DC Voltage Output .....	91
DC Current Output .....	92
Resistance Sourcing .....	93
Frequency Sourcing .....	94
Temperature, Thermocouples .....	95
Temperature, Resistance Temperature Detectors .....	98
Loop Power Supply .....	99
Top and Bottom Limits of Ranges with Auto Range On .....	100
General Specifications .....	102
Index	

# ***List of Tables***

<b>Table</b>	<b>Title</b>	<b>Page</b>
1.	Summary of Source and Measure Functions.....	3
2.	Input/Output Jacks and Connectors.....	12
3.	Key Functions .....	15
4.	Battery Life.....	22
5.	Thermocouple Types Accepted .....	34
6.	RTD Types Accepted.....	36
7.	Simultaneous MEASURE/SOURCE Functions with Loop Power Disabled.....	60
8.	Simultaneous MEASURE/SOURCE Functions with Loop Power Enabled.....	61
9.	Replacement Parts .....	85





# ***List of Figures***

<b>Figure</b>	<b>Title</b>	<b>Page</b>
1.	Standard Equipment .....	5
2.	Accessories.....	8
3.	Definition of Symbols .....	10
4.	Input/Output Jacks and Connectors.....	13
5.	Keys .....	14
6.	Elements of a Typical Display .....	18
7.	Installing the Strap and Using the Bail .....	19
8.	Removing the Battery and Using the Charger .....	21
9.	Electrical Measurement Connections .....	29
10.	Gage and Differential Pressure Modules .....	30
11.	Connections for Measuring Pressure.....	32
12.	Measuring Temperature with a Thermocouple .....	35
13.	Measuring Temperature with an RTD.....	39

14.	Electrical Sourcing Connections .....	42
15.	Connections for Simulating a 4 to 20 mA Transmitter .....	44
16.	Connections for Supplying Loop Power .....	46
17.	Connections for Sourcing Pressure .....	49
18.	Connections for Simulating a Thermocouple .....	51
19.	Connections for Simulating an RTD .....	53
20.	Checking a Relay Output Trip Alarm .....	58
21.	Calibrating a Thermocouple Temperature Transmitter .....	63
22.	Calibrating a Chart Recorder .....	74
23.	Measuring Voltage Drop .....	74
24.	Monitoring AC Line Voltage and Frequency .....	75
25.	Calibrating a Current-to-Pressure (I/P) Transducer .....	76
26.	Measuring the Output Current of a Transmitter .....	77
27.	Measuring a Precision Resistor .....	78
28.	Sourcing Resistance .....	78
29.	Checking a Switch .....	79
30.	Checking a Tachometer .....	79
31.	Calibrating a Pressure-to-Current (P/I) Transducer .....	80
32.	Calibrating a mV to Current Transmitter .....	81
33.	Checking a Vortex Shedding Flowmeter .....	82
34.	Optering Environment Specification .....	103

# ***Documenting Process Calibrator***

## ***Introduction***

Fluke 701 and 702 Documenting Process Calibrators (hereafter referred to as the calibrator) are battery-powered, hand-held instruments that measure and source electrical and physical parameters. See Table 1. The calibrator lets you troubleshoot, calibrate, verify, and document the calibration of process instruments. See the back of this manual for complete specifications.

In addition to the functions in Table 1, the 701 and 702 calibrators have the following features:

- General features:

- Analog display in measurement mode to make it easy to read the input level when the input is unstable.

- Display shows information in English, French, German, Italian, or Spanish.

Thermocouple (TC) input/output jack that is connected to an internal isothermal block with automatic reference-junction temperature compensation. Or, you can manually enter an external temperature reference.

Stores results for later review.

Logs up to 8,000 data points (Model 702 with PMLink software only.)

PC interface for uploading/downloading procedures, lists, and results using PMLink software (Model 702 only).

Automatic calibration procedures for transmitters using split screen MEASURE/SOURCE mode. Once you select the test parameters, you can select an automatic procedure or you can execute the test points one at a time.

- Features available in MEASURE mode:



Damping (smoothing of the last several readings).

Display of measurements in engineering units or percent of scale.

Data logging (Model 702 only).

- Features available in SOURCE mode:











An output ramp feature for testing limit switches. Trip detect is either a 1V change or a continuity status change (Open or Short) from one ramp increment to the next.

An output step feature in which you set the step size and press  or  to step the output in engineering units or percent of scale.

Unless stated otherwise, everything in this manual applies to both the Fluke 701 and 702 Documenting Process Calibrators. For maintenance, repair, performance testing, and calibration instructions, order the 701/702 Service Manual (PN 944525). The phone number in the USA and Canada for replacement parts is: 1-800-526-4731. For service help in the USA and Canada call 1-800-825-9810. For application or operation assistance on Fluke products call:

800-44-FLUKE (800-443-5853) in USA and Canada  
(31 40) 644200 in Europe  
(206) 356-5500 from other countries

**Table 1. Summary of Source and Measure Functions**

FUNCTION	MEASURE	SOURCE
 dc V	0 to $\pm 300V$	0 to 11V in V or mV units (10 mA max)
 ac V	0 to 300V rms, 20 Hz to 5 kHz	No sourcing
 Frequency	1 Hz to 50 kHz, 110 mV to 300V rms	1 mV to 10V pk square wave, 2 Hz to 50 kHz
 Resistance	0 $\Omega$ to 11 k $\Omega$	0 $\Omega$ to 11 k $\Omega$
 dc Current	0 to 110 mA	0 to 22 mA (28V max)
 Continuity	Beep and the word Short indicates continuity	No sourcing
 Thermocouple	E, N, J, L, K, T, U, B, R, S, or C	
 RTD Measure 2,3, or 4 wire.  Source 2 Wire.	100 $\Omega$ Platinum (3926) 100 $\Omega$ Platinum (385) 120 $\Omega$ Nickel (672) 200 $\Omega$ Platinum (385) 500 $\Omega$ Platinum (385) 1000 $\Omega$ Platinum (385) 10 $\Omega$ Copper (427) 100 $\Omega$ Platinum (3916)	
 Pressure	14 modules ranging from 0 to 10" H <sub>2</sub> O (2.5 kPa) to 0 to 10,000 psi (69,000 kPa)	Note
 Loop Power	24 or 28V (22 mA max)	
Note: Use an external hand pump or other pressure source as a pressure stimulus for the source pressure function.		

**Standard Equipment**

The items listed below and shown in Figure 1 are included with your calibrator. If the calibrator is damaged or something is missing, contact the place of purchase immediately. To order replacement parts or spares, see the user-replaceable parts list at the end of this manual.

- TL24 industrial test leads (two sets).
- AC20 test clips (two sets).
- TP20 test probes (one set).
- Model BP7217 rechargeable nickel-cadmium battery pack.
- Model BC7210 battery charger.
- Adjustable quick-release strap.
- Jumper for three-wire RTD measurement connections (two included).
- 701/702 Users Manual.
- 701/702 Quick Reference Guide.
- Registration card.

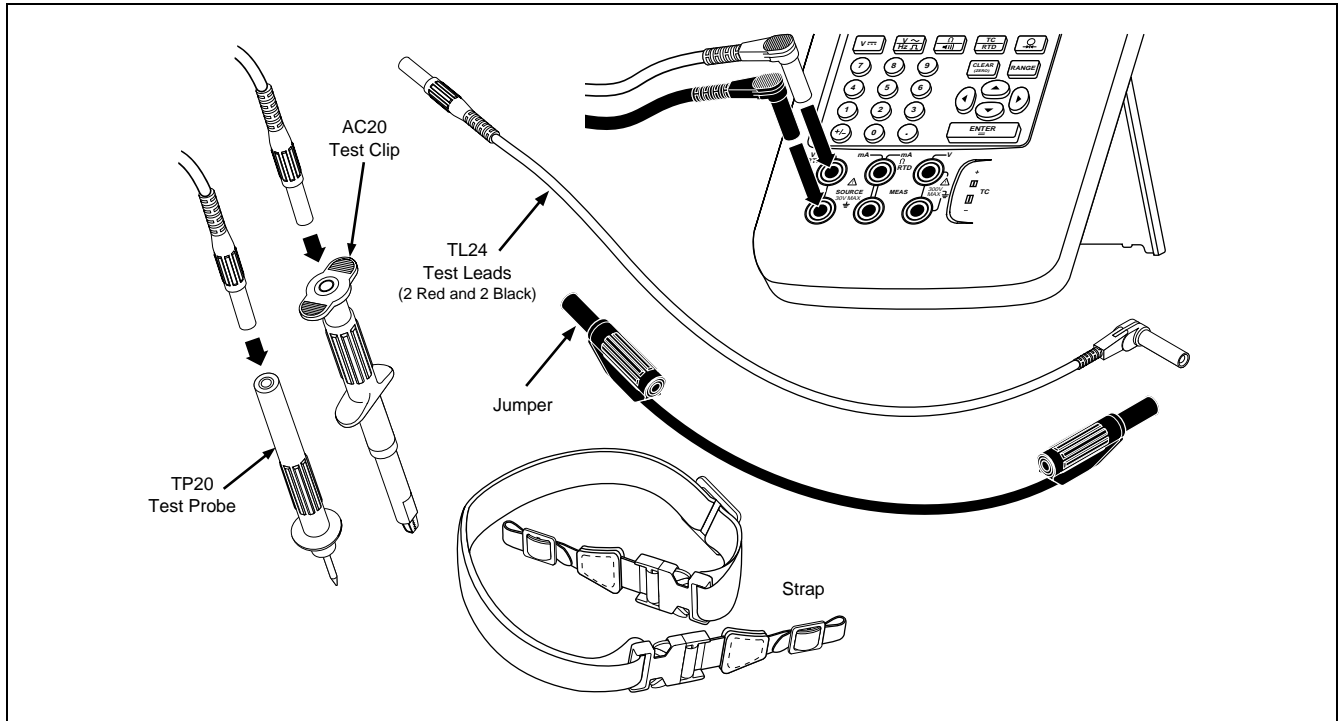

Figure 1. Standard Equipment

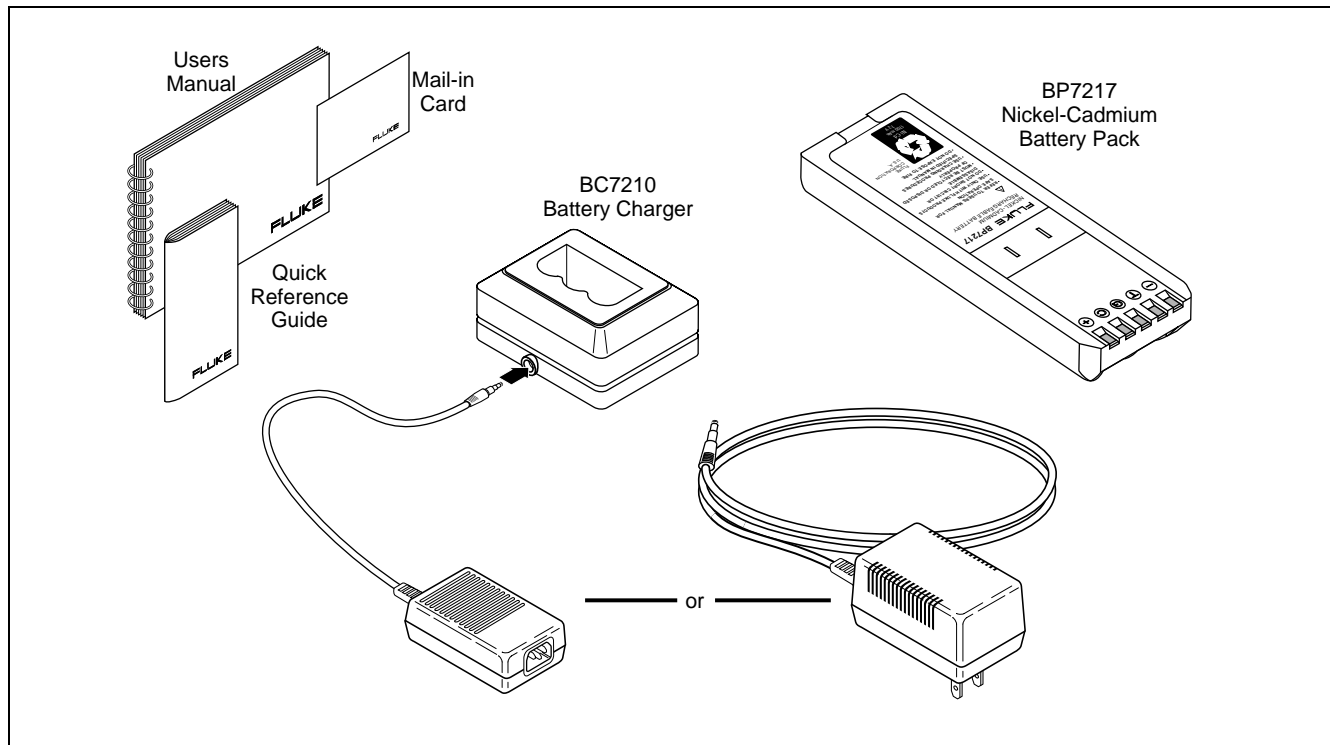

Figure 1. Standard Equipment (cont)



The accessories listed below and shown in Figure 2 are available from Fluke:

- Pressure Modules, Fluke model numbers listed below. (Differential models also operate in gage mode.)

700P01: 0 to 10 inches of H<sub>2</sub>O, or 2.5 kPa  
(differential nonisolated)

700P02: 0 to 1 psi (differential, nonisolated)

700P03: 0 to 5 psi (differential, nonisolated)

700P04: 0 to 15 psi (differential, nonisolated)

700P22: 0 to 1 psi (differential, isolated)

700P23: 0 to 5 psi (differential, isolated)

700P24: 0 to 15 psi (differential, isolated)

700P05: 0 to 30 psi (gage, isolated)

700P06: 0 to 100 psi (gage, isolated)

700P07: 0 to 500 psi (gage, isolated)

700P08: 0 to 1000 psi (gage, isolated)

700P29: 0 to 3000 psi (gage, isolated)

700P30: 0 to 5000 psi (gage, isolated)

700P31: 0 to 10000 psi (gage, isolated)

- Model BE9005 Series Battery Eliminator for bench-top use.
- PMLink software and cable for developing procedures and transferring procedures and data (for Model 702 only).
- Model BP7217 Nickel-Cadmium battery pack.
- Service Kit.
- C700 Carrying Case.

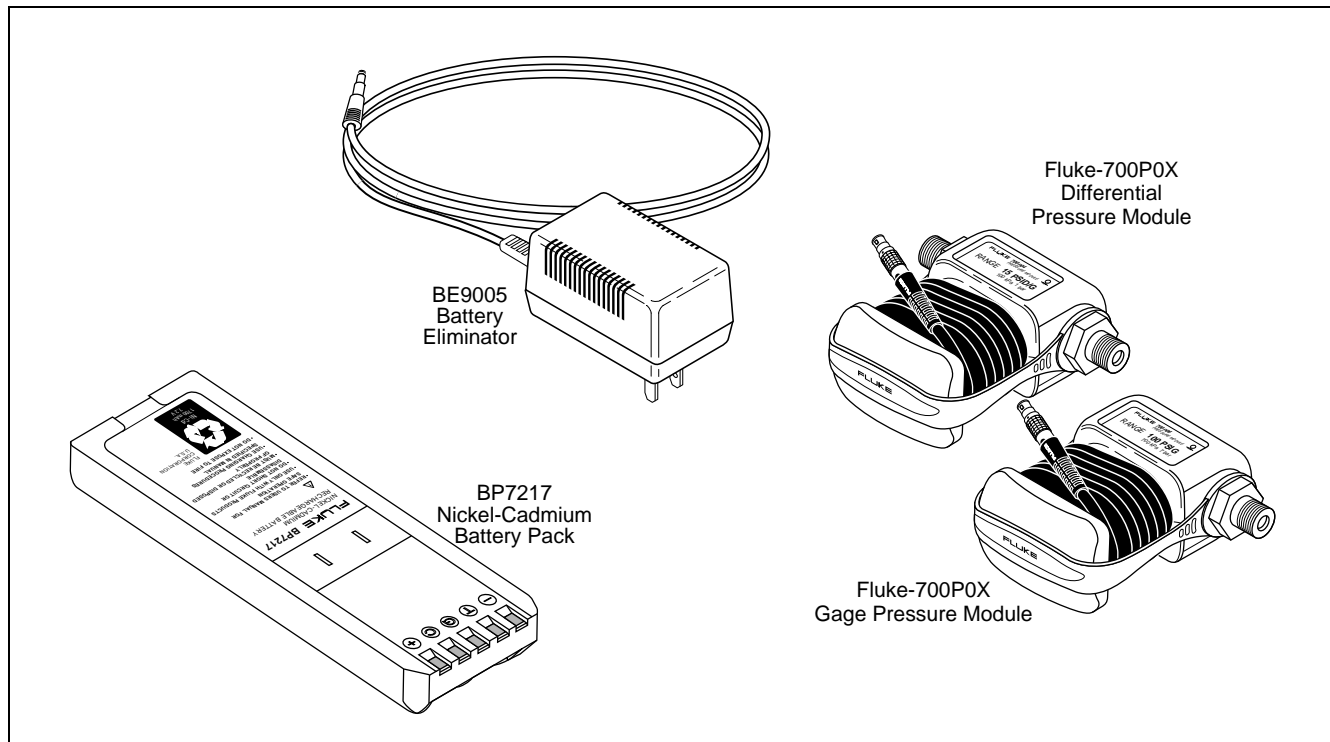

**Figure 2. Accessories**

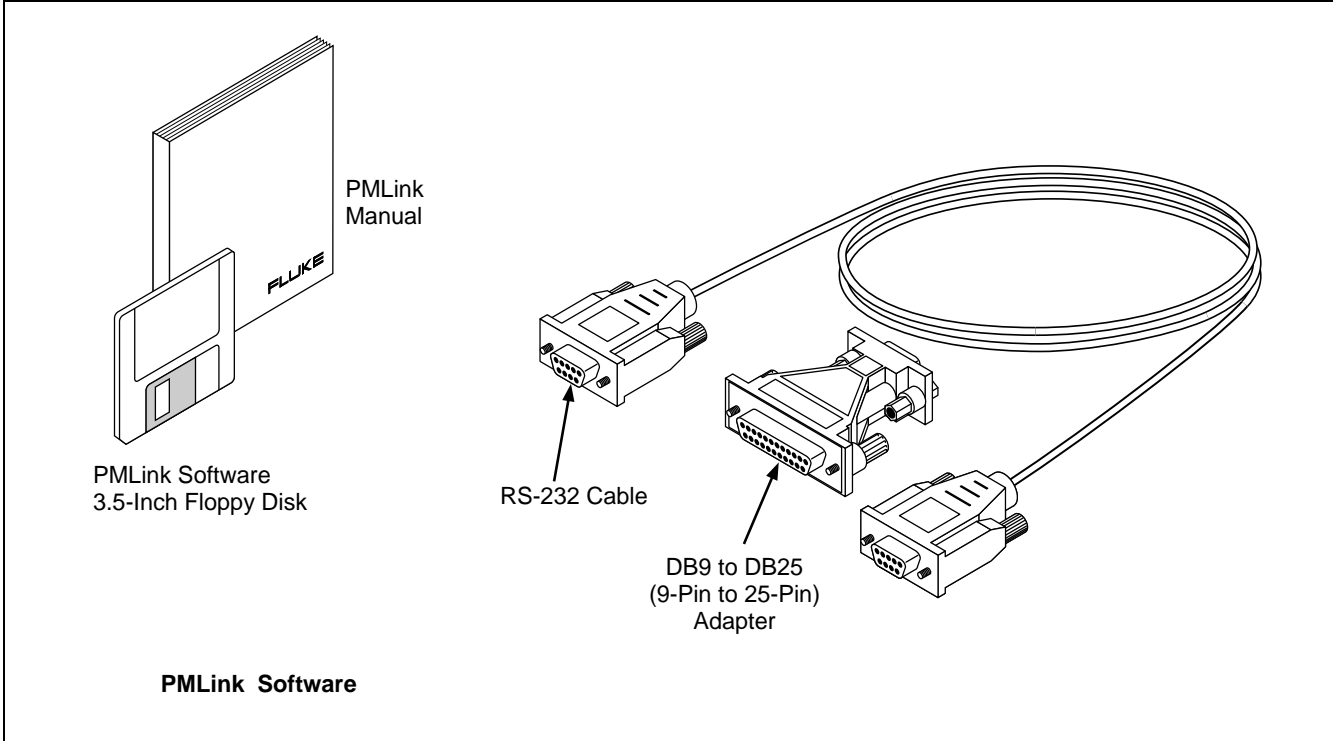









**Figure 2. Accessories (cont)**

## Safety Information

**⚠** This calibrator is designed and tested in accordance with IEC1010-1 and CAN/CSA C22.2 No. 1010.1-92. Use the calibrator only as specified in this manual or in the Quick Reference Guide; otherwise the protection provided by the calibrator may be impaired.

A **WARNING** identifies conditions and actions that pose hazards to the user; a **CAUTION** identifies conditions and actions that may damage the calibrator or the equipment under test.

Symbols used on the calibrator and in this manual are explained in Figure 3.

	AC-Alternating Current		CAUTION see explanation in manual
	DC-Direct Current		Common (LO) Input equipotentiality
	Fuse		ON/OFF
	Pressure		Equipment protected throughout by DOUBLE INSULATION or REINFORCED INSULATION
 Ni-Cd	Recycling	CAT II	Overvoltage (Installation) Category II per IEC 1010-1 refers to the level of Impulse Withstand Voltage protection provided. Typical locations include; Mains Wall outlets, local appliances and PORTABLE EQUIPMENT.

**Figure 3. Definition of Symbols**

To protect yourself, follow these safety guidelines:

- Do not use the calibrator if it is damaged. Before you use the calibrator, inspect the insulating cover. Look for cracks or missing plastic. Pay particular attention to the insulation surrounding the connectors.
- Disconnect the power and discharge all high-voltage capacitors in the equipment under test before testing resistance or continuity.
- Inspect the test leads for damaged insulation or exposed metal. Check test lead continuity. Replace damaged test leads before using the calibrator.
- Do not use the calibrator if it operates abnormally. Protection may be impaired. When in doubt, have the calibrator serviced.
- Select the proper function and range for your measurement.
- Use caution when working above 42V pk, 30V ac rms, or 60V dc. Such voltages pose a shock hazard.
- When using the probes, keep your fingers away from the probe contacts. Keep your fingers behind the finger guards on the probes.
- Connect the common test lead before you connect the live test lead. When you disconnect test leads, disconnect the live test lead first.
- Do not operate the calibrator around explosive gas, vapor, or dust.
- When using a pressure module, make sure the process pressure line is shut off and depressurized before you connect it to the pressure module.
- Disconnect test leads before changing to another measure or source function.
- When servicing the calibrator, use only specified replacement parts.

## Getting Acquainted with Your Calibrator

### Input and Output Jacks

Figure 4 shows the calibrator input and output jacks. Table 2 explains their use.

**Table 2. Input/Output Jacks and Connectors**

ITEM	FEATURE	DESCRIPTION
1	Battery Eliminator jack	Jack for the Model BE9005 Battery Eliminator. Use the battery eliminator for bench-top applications where ac line power is available. This input does not charge the battery. The battery can only be charged in the external charger.
2	⚠ SERIAL PORT (702 Only)	Connects the calibrator to a personal computer. Instructions for communicating with the calibrator are in the PMLink Software manual.
3	Pressure module connector	Connects the calibrator to a pressure module.
4	TC input/output	Jack for measuring or simulating thermocouples. This jack accepts a miniature polarized thermocouple plug with flat, in-line blades spaced 7.9 mm (0.312 in) center to center.
5, 6	⚠ MEAS V jacks	Input jacks for measuring voltage, frequency, or three- or four-wire RTDs (Resistance Temperature Detectors).
7, 8	⚠ SOURCE mA, MEAS mA $\Omega$ RTD jacks	Jacks for sourcing or measuring current, measuring resistance and RTDs, and supplying loop power.
9,10	⚠ SOURCE V $\Omega$ RTD jacks	Output jacks for sourcing voltage, resistance, frequency, and for simulating RTDs

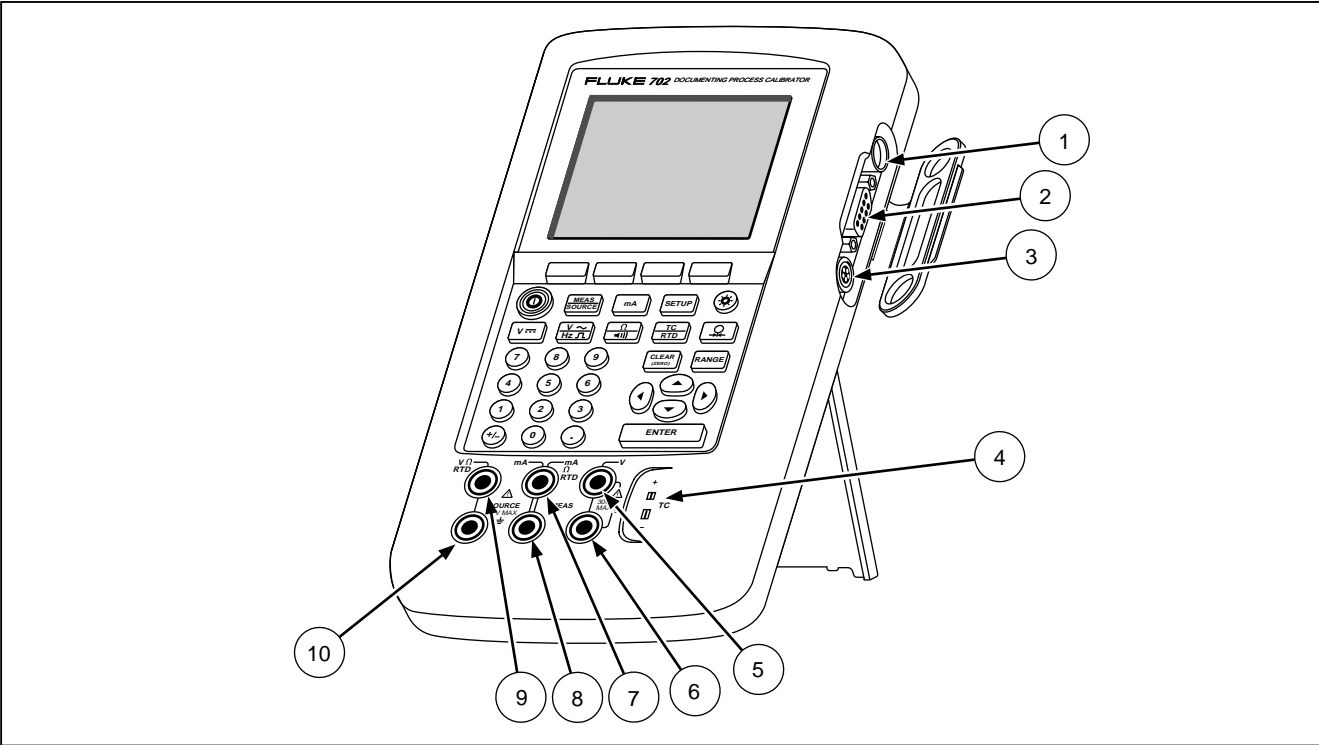

**Figure 4. Input/Output Jacks and Connectors**

## Keys

Figure 5 shows the calibrator keys and Table 3 explains their functions. The softkeys are the four unmarked blue keys just below the display. Softkey functions are defined by the labels that appear above the softkey during operation. Softkey labels and other display text are shown in this manual in bold type, for example, **Choices**.

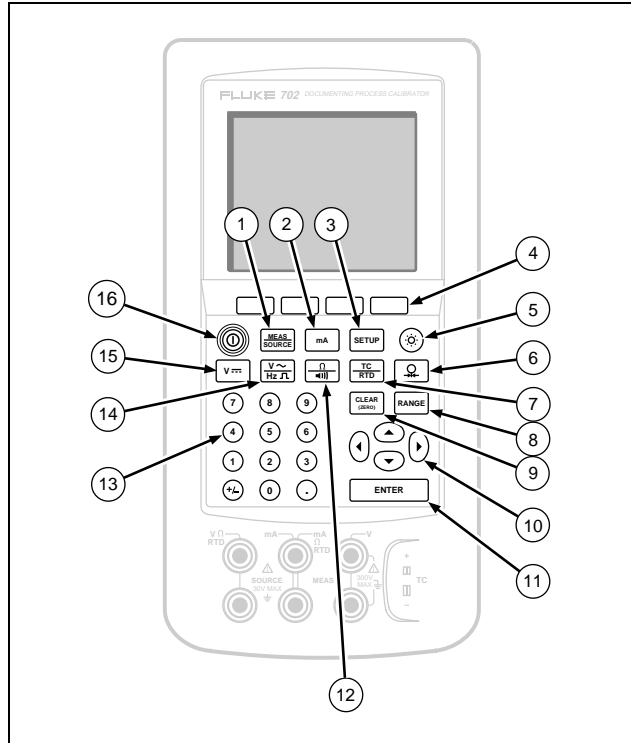

Figure 5. Keys



**Table 3. Key Functions**





















ITEM	FEATURE	DESCRIPTION
1	 key	Cycles the calibrator through MEASURE, SOURCE, and MEASURE/SOURCE modes.
2	 key	Selects mA (current) measure or source function. For loop power on/off, go to the  mode.
3	 key	Enters and exits the  mode to modify operating parameters.
4	Softkeys	Perform the function defined by the label above each key on the display.
5	 key	Turns the backlight on and off.
6	 key	Selects the pressure measurement or sourcing function.
7	 key	Selects TC (thermocouple) or RTD (resistance temperature detector) measurement or sourcing functions.
8	 key	Toggles between autorange and locked range, and increments range. Each time you press  , the calibrator locks on the next range. Press this key again for 2 seconds to resume autorange.
9	 key	Clears a partial data entry, or zeros the output when in the SOURCE mode.
10	 ,  ,  ,  keys	Adjust the display contrast. Also, use these keys to make selections when prompted. These keys also increase or decrease the output in SOURCE mode when using the step feature.

Table 3. Key Functions (cont)

ITEM	FEATURE	DESCRIPTION
11	 key	Terminates a numeric entry when setting a source value, or selects entries from lists.
12	 key	Toggles between resistance and continuity functions in MEASURE mode, or selects the resistance function in SOURCE mode.
13	Numeric keypad	Used whenever a numeric entry is required.
14	 key	Toggles between ac voltage and frequency functions in MEASURE mode, or selects frequency output in SOURCE mode.
15	 key	Selects the dc voltage function in MEASURE mode, or selects dc voltage in SOURCE mode.
16	 key	Turns the power on and off.

## **Display**

Figure 6 shows the features of a typical display. The display shown is MEASURE mode. Near the top of the display is “Source Off.” This is the area of the display that shows what is happening in the other mode (SOURCE or MEASURE). The other parts of the display are as follows:

- **Status Bar:** shows the time and date (if set in Setup mode), and shows the status of Loop Power, Battery Save, and Backlight Timeout; all of which are set in Setup mode. The low battery and backlight on annunciators also appear here.
- **Mode Indicator:** Shows whether the calibrator is in MEASURE or SOURCE mode. In split screen MEASURE/SOURCE mode, there is a Mode Indicator for each window.
- **Measured Value:** Shows the measured value in your choice of engineering units or percent of scale.
- **Range Status:** Shows whether Auto Range is on, and what range is currently being used.

## **Setting Up the Calibrator**

This section consists of general information that should be read before you use the calibrator.

### **Using the Strap and Bail**

After you unpack the calibrator, attach its carrying strap as shown in Figure 7. You can adjust the strap as necessary to hang the calibrator on any sturdy support. Figure 4 also shows you how to prop open the bail to stand the calibrator at a comfortable viewing angle for benchtop use.

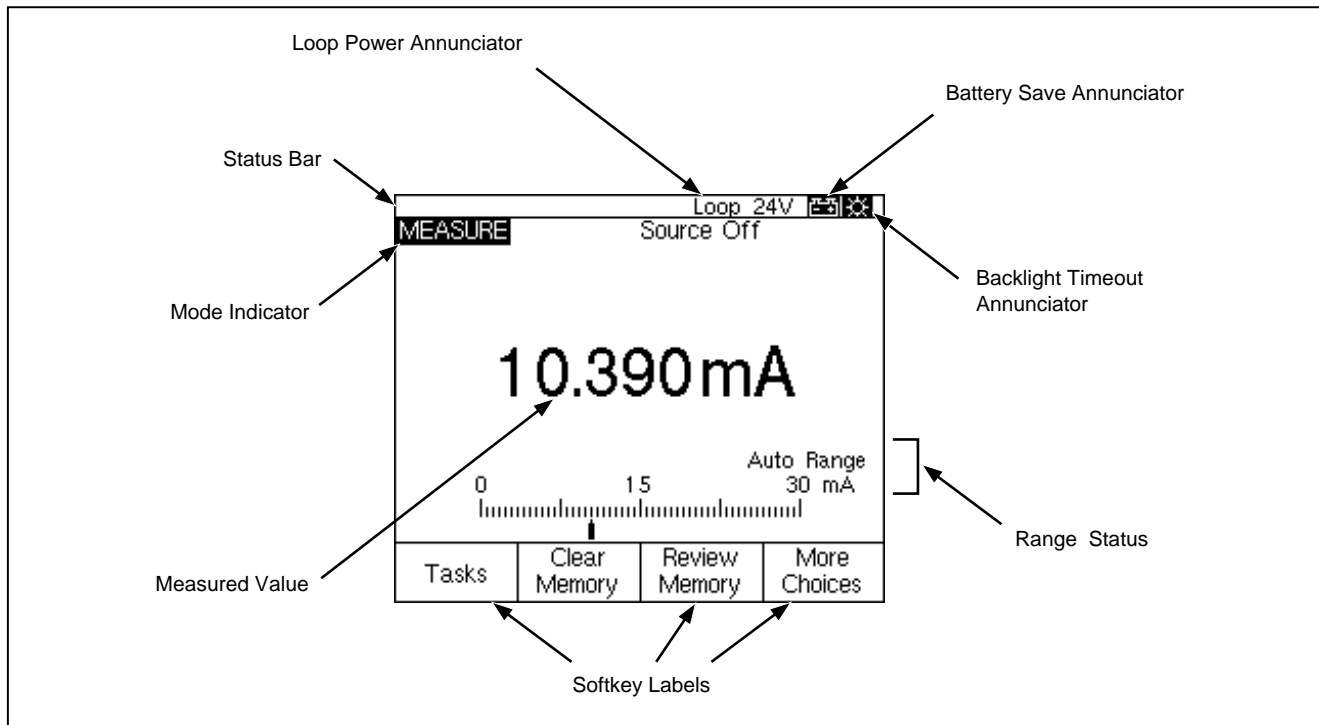
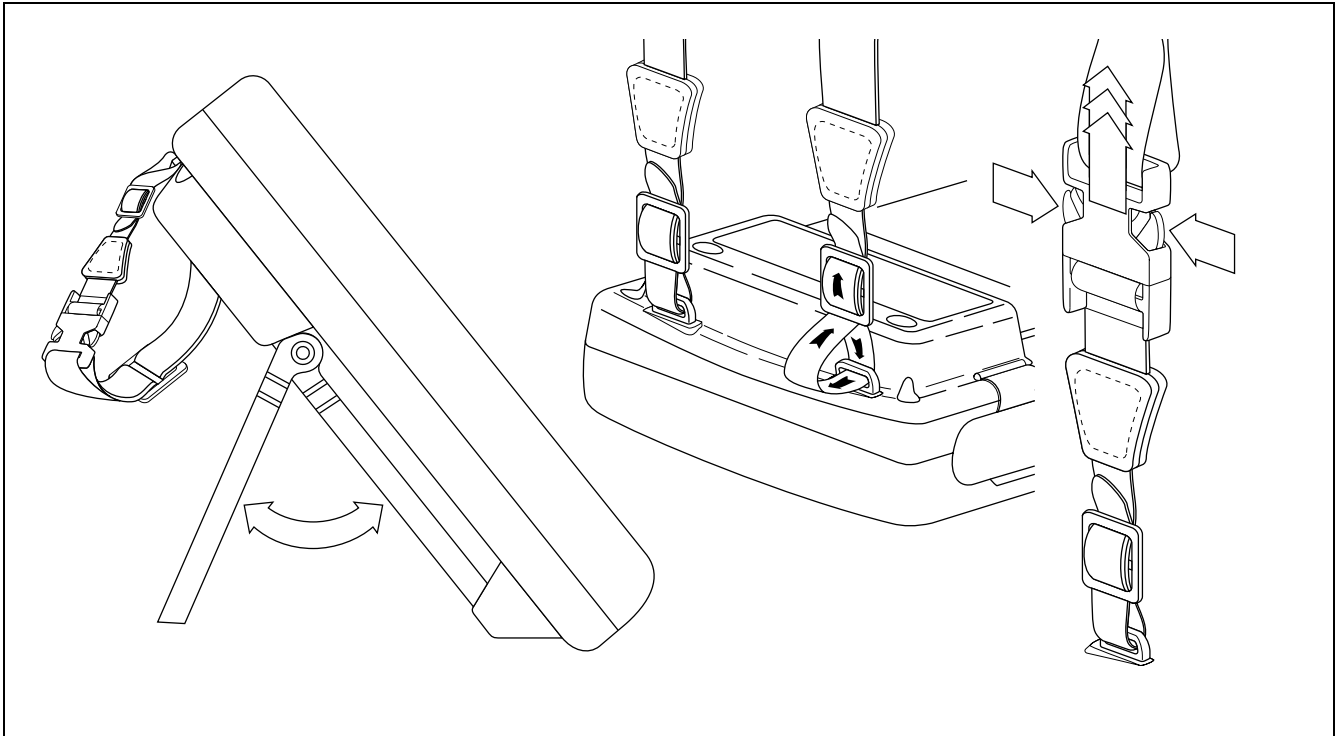

Figure 6. Elements of a Typical Display



**Figure 7. Installing the Strap and Using the Bail**

## ***Charging the Battery***

**⚠** Before you use the calibrator for the first time, charge its battery pack for 2 hours. Due to safety requirements, the battery must be charged outside the calibrator.

Figure 8 shows how to remove the battery. Remove the battery door and tap the calibrator with your hand to get the battery out. Place the battery in the charger and connect the charger to line power. The charger automatically senses line voltage and adjusts itself accordingly.

A discharged battery is fully charged in 2 hours or less in fast-charge mode (steady indicator light on the charger). Full charge is maintained after that time in trickle-charge mode (blinking indicator light on the charger). Switching between charging modes is automatic. You can leave the battery pack on trickle charge indefinitely without damage.

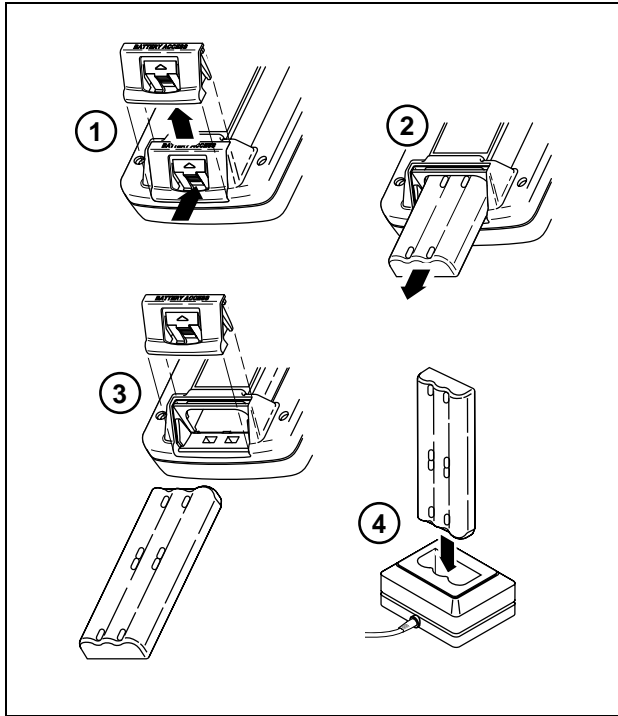

### **NOTE**

*When you remove a charged battery from the charger, wait for the blinking indicator to go off before you insert a discharged battery. It takes about 2 seconds for the battery charger to reset.*



**Figure 8. Removing the Battery and Using the Charger**

## **Battery Life**

Table 4 shows the operating time for a new, fully charged battery pack. Calibrator performance is guaranteed to meet specifications until the low battery annunciator  located at the top right side of the display appears and the beeper beeps every 4 seconds. When the  annunciator appears, stop using the calibrator and charge the battery. If you have a fully charged spare battery, exchange it with the low battery.

The battery is useful for up to 1,000 charge/discharge cycles. If you need to replace the battery, refer to “Replacing the Battery” later in this manual for instructions. For longest battery life and best performance, wait for  to appear before you charge the battery.







**Table 4. Battery Life**



<b>OPERATING MODES</b>	<b>BACKLIGHT OFF</b>	<b>BACKLIGHT ON</b>
Measure, continuous	6.5 Hours	6 Hours
Measure and source, with loop power on, continuous	3.5 Hours	3 Hours
Typical intermittent operation	>8 Hours	>8 Hours



## **Automatically Saving Battery Life**

An optional **Auto Battery Save** feature turns the calibrator off after a selected idle time. The default setting for **Auto Battery Save** is **Off**. When **Auto Battery Save** is **On**, the  symbol shows in the upper right corner of the display. The setting is preserved after you turn off the power. Auto Battery Save works the same on battery power and when using the battery eliminator. Turn on the **Auto Battery Save** feature as follows:

1. Press .
2. Press  to highlight **Off** following **Auto Battery Save**.
3. Press  or the **Choices** softkey.
4. Press  to highlight **On**, then press .
5. To accept the timeout period shown on the display, you can finish here. Press **Done** to exit  mode and do not go on to step 6.
6. To change the timeout period, press  to highlight the timeout period following **Battery Save Timeout**.

7. Press  or the **Choices** softkey.
8. Enter your choice of timeout period in minutes (accepted range: 1 to 120 minutes).
9. Press the **Done** softkey.
10. Press the **Done** softkey or  to exit  mode.

## **Using the Optional Battery Eliminator**

### **CAUTION**

**To avoid damage to the calibrator, use only Fluke Model BE9005 Series Battery Eliminator, available from your distributor.**

Where ac power is available, you can use the optional Fluke Model BE9005 Battery Eliminator to conserve battery power. When the battery eliminator is used, the battery is internally disconnected, and can be removed from the calibrator. The calibrator operates the same as it does under battery power, however, the specifications for the 701/702 only apply under battery operation. The battery eliminator does not charge the battery.

## **Selecting the Display Language**

The calibrator displays information in five languages. English language is the default. To change the display language, proceed as follows:

1. Press **SETUP**.
2. Press the third softkey from the left twice.
3. Press **▼** three times.
4. Press **ENTER**.
5. Press **▲** or **▼** to highlight your choice of language.
6. Press **ENTER** to confirm your choice. The language you choose is the power-up default.
7. Press **SETUP** to exit **SETUP** mode.

## **Adjusting the Display Contrast**

Press **▲** or **▶** to increase contrast. Press **◀** or **▼** to decrease contrast. When the **▲** and **▼** keys are being used to select an item from a list, for example in **SETUP** mode, use the **◀** and **▶** keys.

## **Setting Up the Date and Time Display**

The date and time are optionally displayed at the top of the display during normal operation. In **SETUP** mode you can turn on or off this date and time display. You can also control the format used to display the date and time. You should set the calendar and clock whether or not you use the date and time display, since a timestamp is applied to all saved results. Proceed as follows to set up the time and date displays:

1. Press **SETUP**.
2. Press the **Next Page** softkey. The display appears as follows:

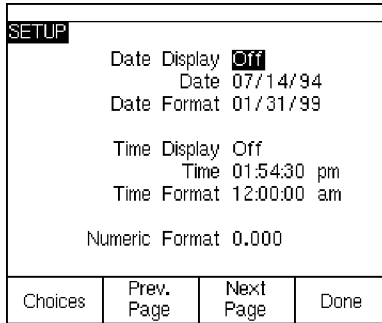

- Use the and keys to move the cursor to the parameter you want to change, then press or the **Choices** softkey to choose a setting for that parameter. For example, the following display appears after you select **Date Format**:

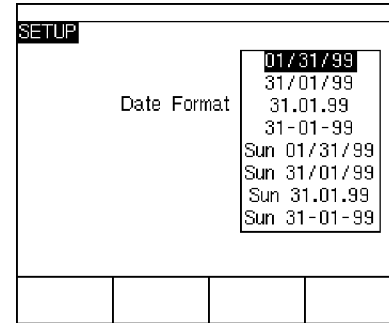











- Press or to move the cursor to the desired date format.
- Press to go back to the **SETUP** display.
- Make another selection or press the **Done** softkey or to save your settings and exit mode.

### **Using the Backlight**

Press to turn on the display backlight. Press again to turn it off. When the backlight is on, the symbol shows at the top of the display. If desired, you can minimize battery usage by setting the calibrator to turn the display backlight off automatically. When the backlight is turned on and



Auto Backlight Off is activated, the  symbol shows at the top of the display. To automatically turn off the backlight after a set time, proceed as follows:

1. Press .
2. Press  to highlight **Off** following **Auto Backlight Off**.
3. Press  or the **Choices** softkey.
4. Press  to highlight **On**, then press .
5. To accept the timeout period shown on the display, you can finish here. Press **Done** to exit  mode and do not go on to step 6.
6. To change the timeout period, press  to highlight the timeout period following **Backlight Timeout**.
7. Press  or the **Choices** softkey.
8. Enter your choice of timeout period in minutes (accepted range: 1 to 120 minutes).
9. Press the **Done** softkey.

10. Press the **Done** softkey or  to exit  mode.

### ***Personalizing the Calibrator***

You can load your name or some another alphanumeric identifier into the calibrator for display at power-up and in saved results. Proceed as follows to load an identifier:

1. Press .
2. Press **Next Page** twice.
3. Press  to move the cursor to the same line as **ID**.
4. Press  or the **Choices** softkey. The display appears as follows:

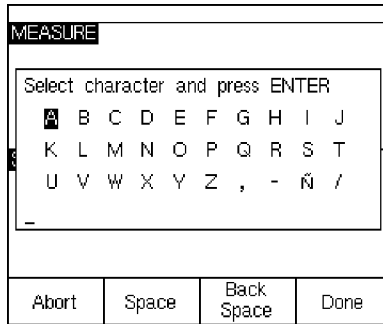

5. The **ID** string is shown at the bottom of the boxed area. To erase a character, press the **Back Space** softkey. To erase the whole string, press **CLEAR (ZERO)**.
6. Press **▲**, **▼**, **◀**, or **▶** to select a character, then press **ENTER**. Use the numeric keypad if you want to enter a number.
7. Repeat step 6 until you are satisfied with the **ID** string appearing in the window.
8. Press the **Done** softkey.
9. Press the **Done** softkey or **SETUP** to exit **SETUP** mode.

## Using Measure Mode

### NOTE

*To achieve best measurement noise and accuracy performance, do not use the battery eliminator, and tie all three common jacks together.*

The operating mode (i.e., MEASURE, SOURCE) is shown in a reverse-video bar on the display. If the calibrator is not in MEASURE mode, press **MEAS SOURCE** until MEASURE is shown. You must be in MEASURE mode to change any of the MEASURE parameters.





## Measurement Ranges

The calibrator normally changes to the appropriate measurement range automatically. The lower right side of the display shows either “Range” or “Auto Range” depending on the range status. Auto Range switch points are shown in the Specifications at the end of this manual. When you press the **▶** key, the range is locked. Press it again to cycle to and lock on the next higher range. Press it and hold it for two seconds to revert to Auto Range.



If the range is locked, overrange inputs produce a display of - - - - -. In Auto Range, out of range inputs produce a display of ! ! ! ! ! ! ! !.

## **Measuring Electrical Parameters**

When you turn on the calibrator, it powers up in the dc voltage measurement function. To select an electrical measurement function from either SOURCE or MEASURE/SOURCE mode, first press  for MEASURE mode, then proceed as follows:

1. Press  for current,  for dc voltage,  once for ac voltage or twice for frequency, or  for resistance.

### **NOTE**

*To measure frequency you are prompted to select a frequency range as shown next. If you expect the frequency you are measuring to be below 20 Hz, press  to select the lower frequency range, then press .*

2. Connect the test leads as shown in Figure 9, depending on the measurement function.

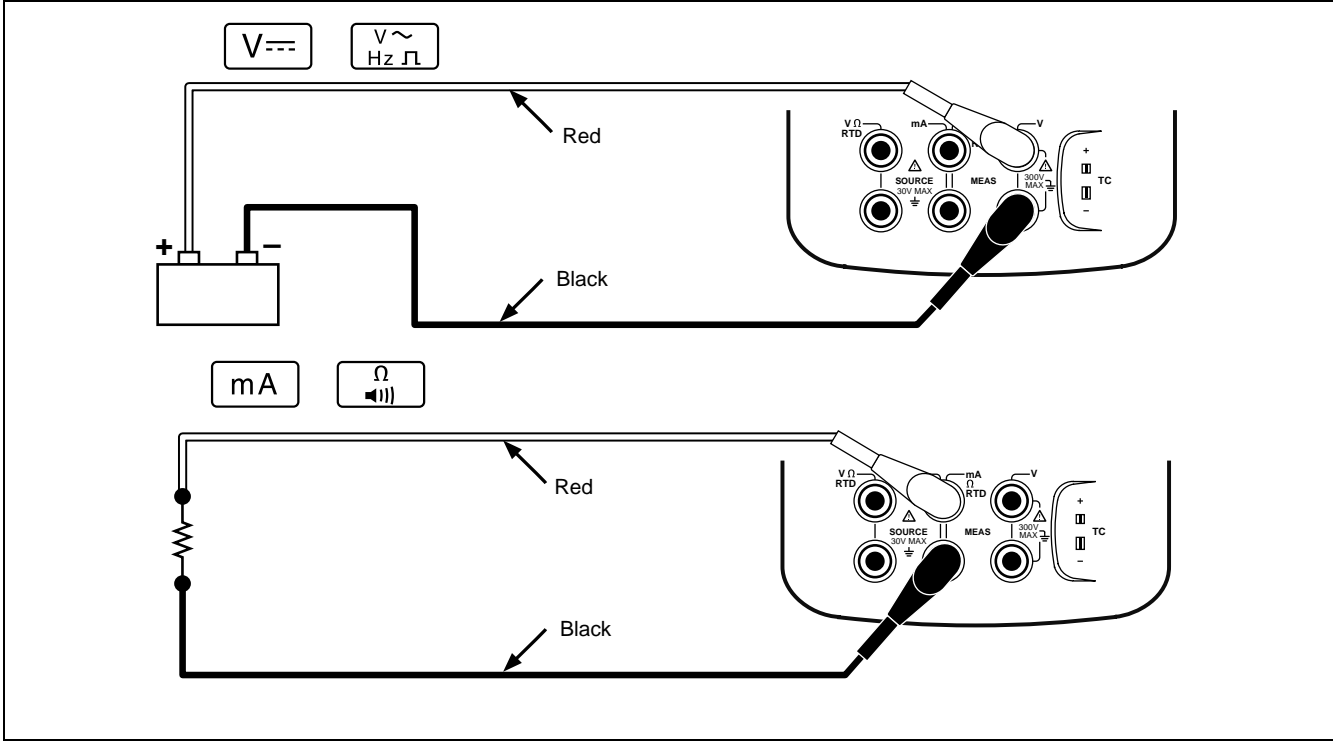



Figure 9. Electrical Measurement Connections

## Testing Continuity

In the continuity function, the beeper sounds and the word **Short** appears on the display when the resistance between the  $\Omega$  MEAS jack and its common jack is less than  $10\Omega$ . The word **Open** appears when the resistance is greater than  $400\Omega$ . Proceed as follows to test continuity:

1. Remove power from the circuit to be tested.
2. If necessary, press  for MEASURE mode.
3. Press  twice so that **Open** appears.
4. Connect the calibrator to the circuit to be tested as Figure 9 shows.

## Measuring Pressure

To measure pressure, attach the appropriate pressure module for the pressure to be tested. Pressure modules are available in gage or differential types depending on range. (See “ACCESSORIES” near the front of this manual.) Gage pressure modules have one pressure fitting and measure the process pressure with respect to atmospheric pressure. Differential pressure modules have two pressure fittings and

measure the difference between the applied pressure on the high fitting versus the low fitting. Figure 10 shows the two types.

Proceed as follows to measure pressure:

### WARNING

**TO AVOID A VIOLENT RELEASE OF PRESSURE IN A PRESSURIZED SYSTEM, SHUT OFF THE VALVE AND SLOWLY BLEED OFF THE PRESSURE BEFORE YOU ATTACH THE PRESSURE MODULE TO THE PRESSURE LINE.**

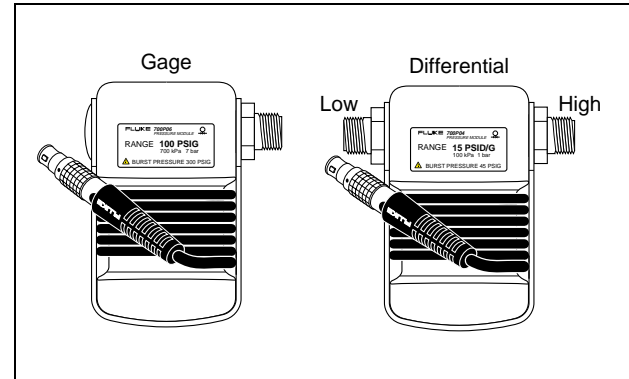









Figure 10. Gage and Differential Pressure Modules



### CAUTION

**To avoid mechanically damaging the pressure module, never apply more than 10 ft.-lbs. of torque between the pressure module fittings or between the fittings and the body of the module. Always apply appropriate torque between the pressure module fitting and connecting fittings or adapters. To avoid damaging the pressure module from overpressure, never apply pressure above the rated maximum printed on the pressure module. To avoid damaging the pressure module from corrosion, use them only with specified materials. Refer to the pressure module instruction sheet for the specified material compatibility for your pressure module.**

1. Connect a pressure module to the calibrator as shown in Figure 11. The threads on the pressure modules accept standard ¼ NPT pipe fittings. Use the supplied ¼ NPT to ¼ ISO adapter if necessary.
2. Press  for MEASURE mode.
3. Press . The calibrator automatically senses which pressure module is attached and sets its range accordingly.
4. To zero the pressure module, vent the module to atmosphere, and press . Repeat this step until the reading is zeroed. You must perform this step before you execute a PMLink Task that measures pressure.
5. If necessary, you can change pressure display units to psi, mmHg, inHg, inH<sub>2</sub>O, ftH<sub>2</sub>O, bar, or kPa as follows:
  - a. Press .
  - b. Press **Next Page** twice.
  - c. Press  or the **Choices** softkey with the cursor on **Pressure Units**.
  - d. Select the pressure units with the  or  keys.
  - e. Press .
  - f. Press the **Done** softkey.

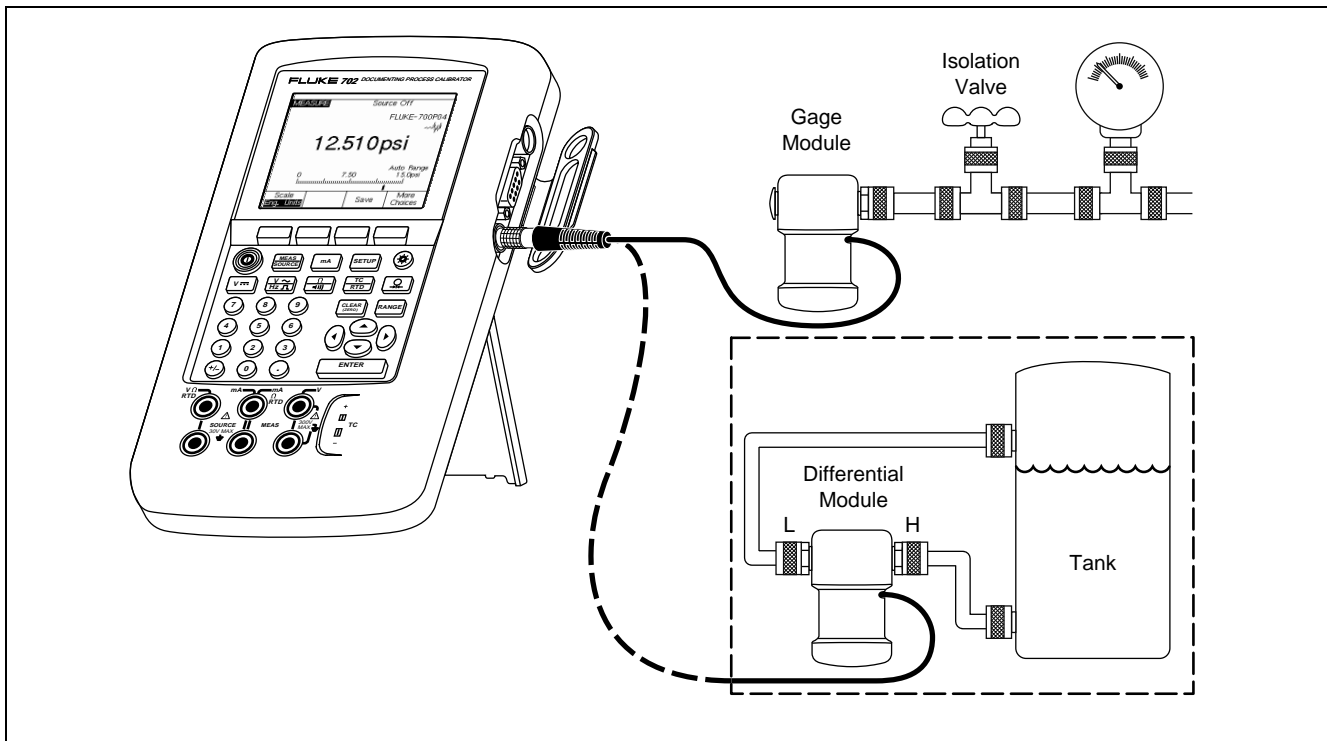

Figure 11. Connections for Measuring Pressure

## Measuring Temperature

### Using Thermocouples

The calibrator supports eleven standard thermocouples, each identified with an alpha character: C, L, U, E, N, J, K, T, B, R, or S. Table 5 summarizes the ranges and characteristics of the supported thermocouples.

To measure temperature using a thermocouple, proceed as follows:

1. Attach the thermocouple leads to the appropriate TC miniplug, then to the TC jack as shown in Figure 12. *One pin is wider than the other. Do not try to force a miniplug in the wrong polarization.*

#### NOTE

*If the calibrator and the thermocouple plug are at different temperatures, wait one minute or more for the connector temperature to stabilize after you plug the connector into the TC jack.*

2. If necessary, press  for MEASURE mode.

















3. Press  so that the display prompting you to select the TC type shows.
4. Select the desired TC type using the  or  followed by .
5. If necessary, you can change between °C or °F **Temperature Units** in  mode as follows:
  - a. Press .
  - b. Press the **Next Page** softkey twice.
  - c. Use the  and  keys to move the cursor to the parameter you which to change, then press  or the **Choices** softkey to choose a setting for that parameter.
  - d. Press  or  to move the cursor to the desired setting.
  - e. Press  to go back to the  display.
  - f. Press the Done softkey or  to exit  mode.
6. If necessary, you can change between **ITS-90** or **IPTS-68 Temperature Scale** in  mode. The procedure is the same as steps a through f above.

Table 5. Thermocouple Types Accepted

TYPE	POSITIVE LEAD MATERIAL	POSITIVE LEAD (H) COLOR		NEGATIVE LEAD MATERIAL	SPECIFIED RANGE (°C)
		ANSI*	IEC**		
E	Chromel	Purple	Violet	Constantan	-250 to 1000
N	Ni-Cr-Si	Orange		Ni-Si-Mg	-270 to 1300
J	Iron	White	Black	Constantan	-210 to 1200
K	Chromel	Yellow	Green	Alumel	-270 to 1372
T	Copper	Blue	Brown	Constantan	-250 to 400
B	Platinum (30% Rhodium)	Gray		Platinum (6% Rhodium)	600 to 1820
R	Platinum (13% Rhodium)	Black	Orange	Platinum	-20 to 1767
S	Platinum (10% Rhodium)	Black	Orange	Platinum	-20 to 1767
C ***	Tungsten (5% Rhenium)	White		Tungsten (26% Rhenium)	0 to 2316
L (DIN J)	Iron			Constantan	-200 to 900
U (DIN T)	Copper			Constantan	-200 to 600

\*American National Standards Institute (ANSI) device negative lead (L) is always red.  
\*\*International Electrotechnical Commission (IEC) device negative lead (L) is always white.  
\*\*\* Not an ANSI designation but a Hoskins Engineering Company designation.

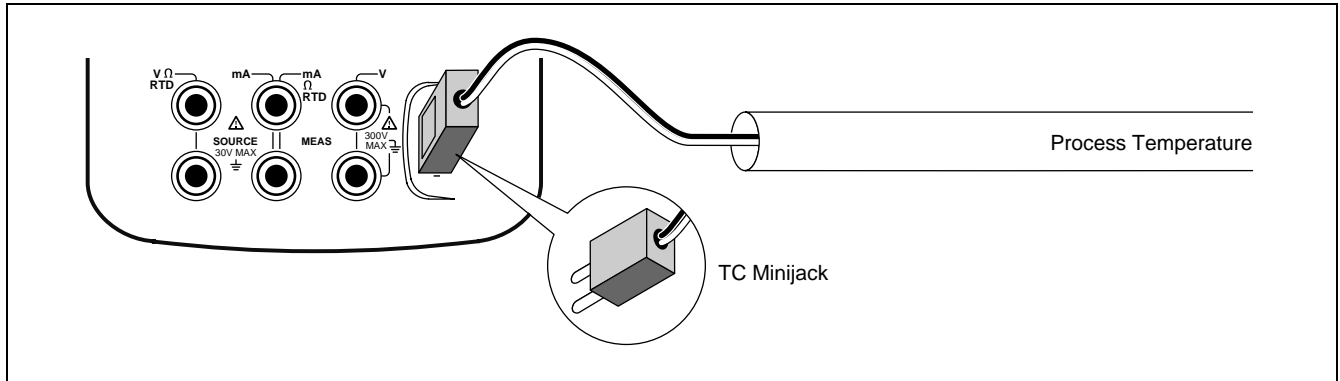

**Figure 12. Measuring Temperature with a Thermocouple**

### Using Resistance-Temperature Detectors (RTDs)

The calibrator accepts RTD types shown in Table 6. RTDs are characterized by their resistance at 0°C (32°F), which is called the “ice point” or  $R_0$ . The most

common  $R_0$  is 100Ω. Most RTDs come in a three-terminal configuration. The calibrator accepts RTD measurement inputs in two-, three-, or four-wire connections. A four-wire configuration provides the highest measurement precision, and two-wire provides the lowest measurement precision.









**Table 6. RTD Types Accepted**

RTD TYPE	ICE POINT ( $R_0$ )	MATERIAL	$\alpha$	RANGE (°C)
Pt100 (3926)	100Ω	Platinum	0.003926Ω/°C	-200 to 630
*Pt100 (385)	100Ω	Platinum	0.00385Ω/°C	-200 to 800
Ni120	120Ω	Nickel	0.00672Ω/°C	-80 to 260
Pt100 (3916)	100Ω	Platinum	0.003916Ω/°C	-200 to 630
Pt200 (385)	200Ω	Platinum	0.00385Ω/°C	-200 to 630
Pt500 (385)	500Ω	Platinum	0.00385Ω/°C	-200 to 630
Pt1000 (385)	1000Ω	Platinum	0.00385Ω/°C	-200 to 630
Cu 10 (427)	9.035Ω **	Copper	0.00427Ω/°C	-100 to 260

\*Per IEC 751-Standard

\*\*10Ω @ 25°C

To measure temperature using an RTD input, proceed as follows:

1. If necessary, press  for MEASURE mode.
2. Press  twice so that **Select RTD Type** shows.
3. Press  or  to select the desired RTD type.
4. Press .
5. Press  or  to select a 2-, 3-, or 4- wire connection.
6. Attach the RTD to input jacks as the display or Figure 13 shows. Use the supplied jumper between the mA  $\Omega$  RTD MEAS low jack and the V MEAS low jack as shown if you are using a 3-wire connection.
7. Press .

### CAUTION

**Do not force a dual banana plug between any two jacks in the horizontal orientation. (See the Figure.) Doing so will damage the jacks. Use the supplied jumper wire when needed for RTD measurements. You can use a dual banana plug in the vertical orientation.**

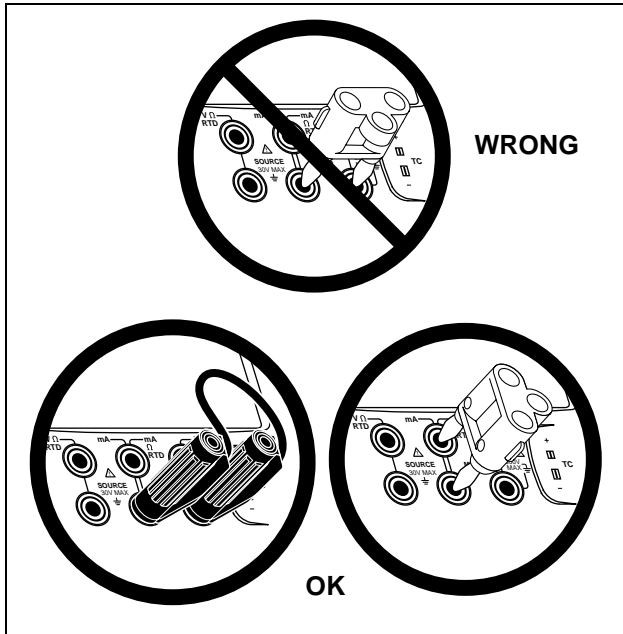

8. If necessary, you can change between °C or °F **Temperature Units** in **SETUP** mode as follows:

- a. Press **SETUP**
- b. Press the **Next Page** softkey twice.

- c. Use the **▲** and **▼** keys to move the cursor to the parameter you which to change, then press **ENTER** or the **Choices** softkey to choose a setting for that parameter.

- d. Press **▲** or **▼** to move the cursor to the desired setting.

- e. Press **ENTER** to go back to the **SETUP** display.

- f. Press the **Done** softkey or **SETUP** to exit **SETUP** mode.

9. If necessary, you can change between **ITS-90** or **IPTS-68 Temperature Scale** in **SETUP** mode. The procedure is the same as steps a through f above.



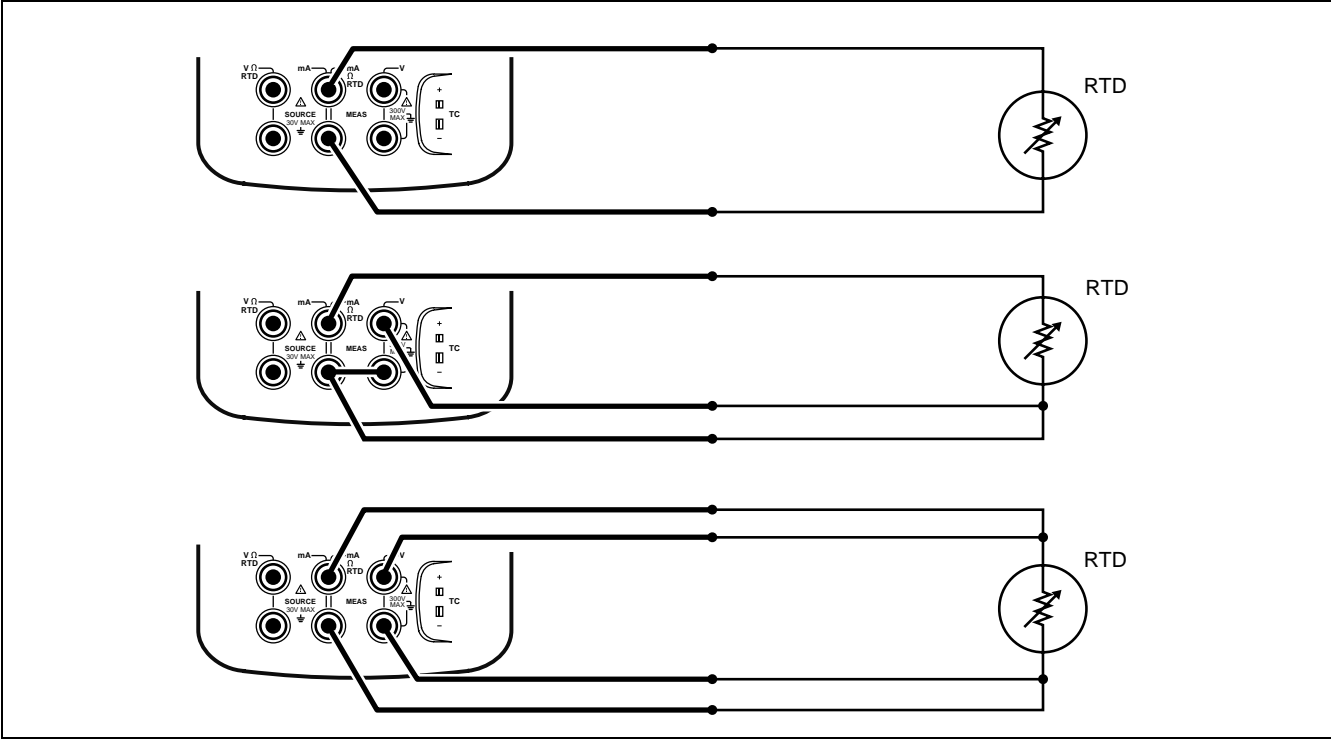
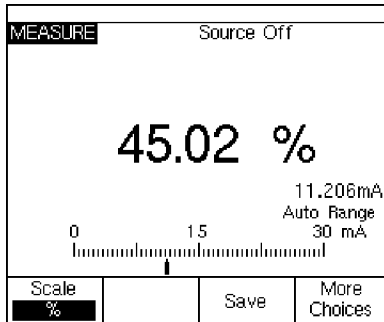

Figure 13. Measuring Temperature with an RTD

## Measurements in Percent of Scale

To display measurements as a percent of scale as shown below, proceed as follows:



1. If necessary, press **MEAS SOURCE** for MEASURE mode.
2. Select a measurement function (**mA**, **V---**, **n**, **TC RTD**, or **Ω**) as previously described.
3. Press the **Scale** softkey.
4. Use the numeric keypad to enter the 0% of scale value.
5. Press **ENTER**.

6. Use the numeric keypad to enter the 100% of scale value.
7. Press **ENTER**.
8. Press the **Done** softkey.

Percent of scale remains in effect until you press the **Scale** softkey again or change to another measurement function.

## Damping Your Measurements

The calibrator normally applies a software filter to dampen measurements in all functions except continuity. The specifications assume that damping is turned on. The damping method is a running average of the last several measurements. Fluke recommends that you leave damping on. Turning damping off may be useful when measurement response is more important than accuracy or noise reduction. If you want to turn off damping, press the **More Choices** softkey twice, then press the **Dampen** softkey so that **Off** appears. Press **Dampen** again to turn damping back on. The default state is **On**.

**NOTE**





*If a measurement falls outside a random noise window, a new average is started. If damping is turned off, or until measurements are fully damped, the  symbol is displayed.*







## Using Source Mode

The operating mode (i.e., MEASURE, SOURCE) is shown in a reverse-video bar on the display. If the calibrator is not in SOURCE mode, press  until SOURCE is shown. You must be in SOURCE mode to change any of the SOURCE parameters.

### Sourcing Electrical Parameters



To select an electrical sourcing function, proceed as follows:

1. Connect the test leads as shown in Figure 14, depending on the source function.
2. Press  for current,  for dc voltage,  for frequency, or  for resistance.

3. Enter the desired output value, then press . For example, to source 5.0V dc, press    .
4. To change the output value enter a new value and press .

**NOTE**

*If you are sourcing current, wait for the  symbol to go out before you use the output.*

5. To set the output value to 0 in the present source function, press .
6. To turn off sourcing completely, press  twice.

**NOTE**

*Use the source current function to drive a current loop. This is different than the loop power function in which the calibrator is powering a process instrument. To source loop power, use the **Loop Power** function accessible from  mode.*

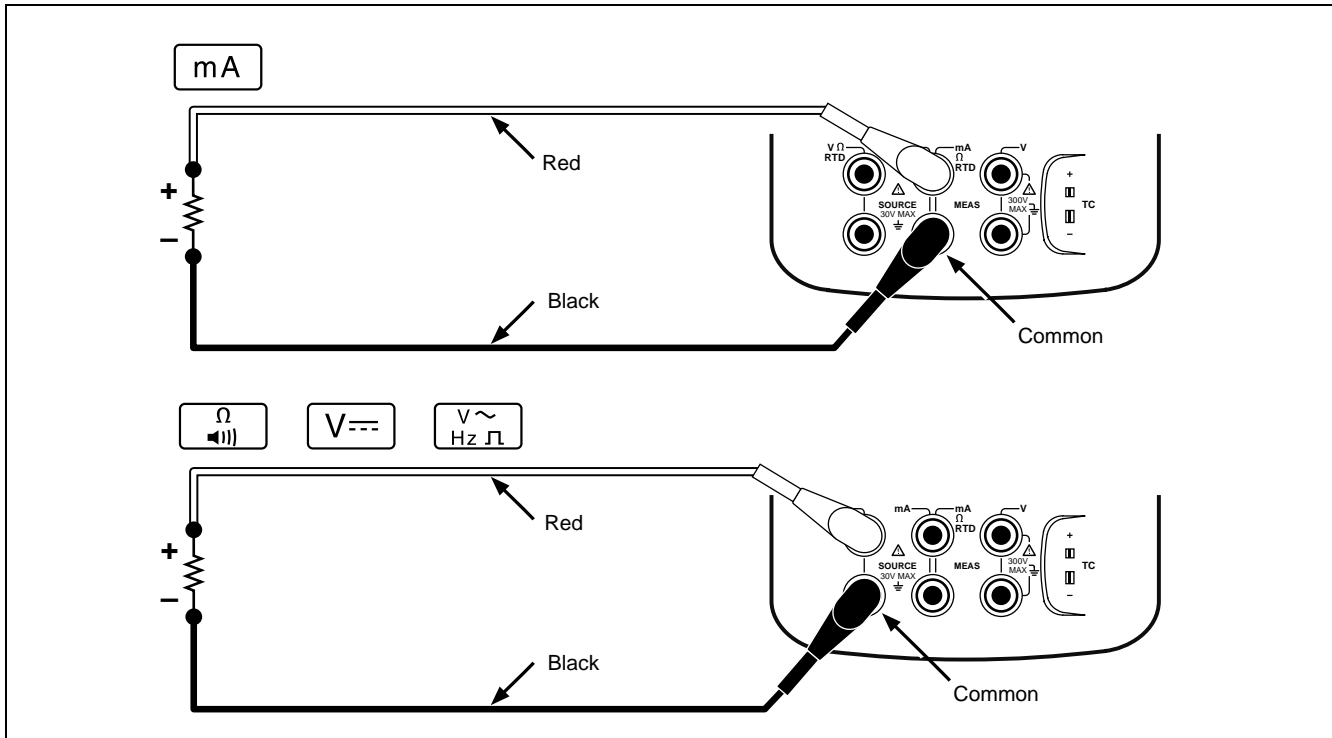



Figure 14. Electrical Sourcing Connections

### ***Simulating a 4 to 20 mA Transmitter***

You can configure the calibrator as a load on a current loop through the SOURCE mA function. When you press the  key in SOURCE mode, the display prompts you to select **Source mA** or **Simulate Transmitter**. The difference in operation is that when you **Source mA** the calibrator is sourcing current, and when you **Simulate Transmitter** the calibrator is sourcing a variable resistance to regulate current to the specified value. Connect an external loop supply to the positive (top) mA jack as shown in Figure 15.

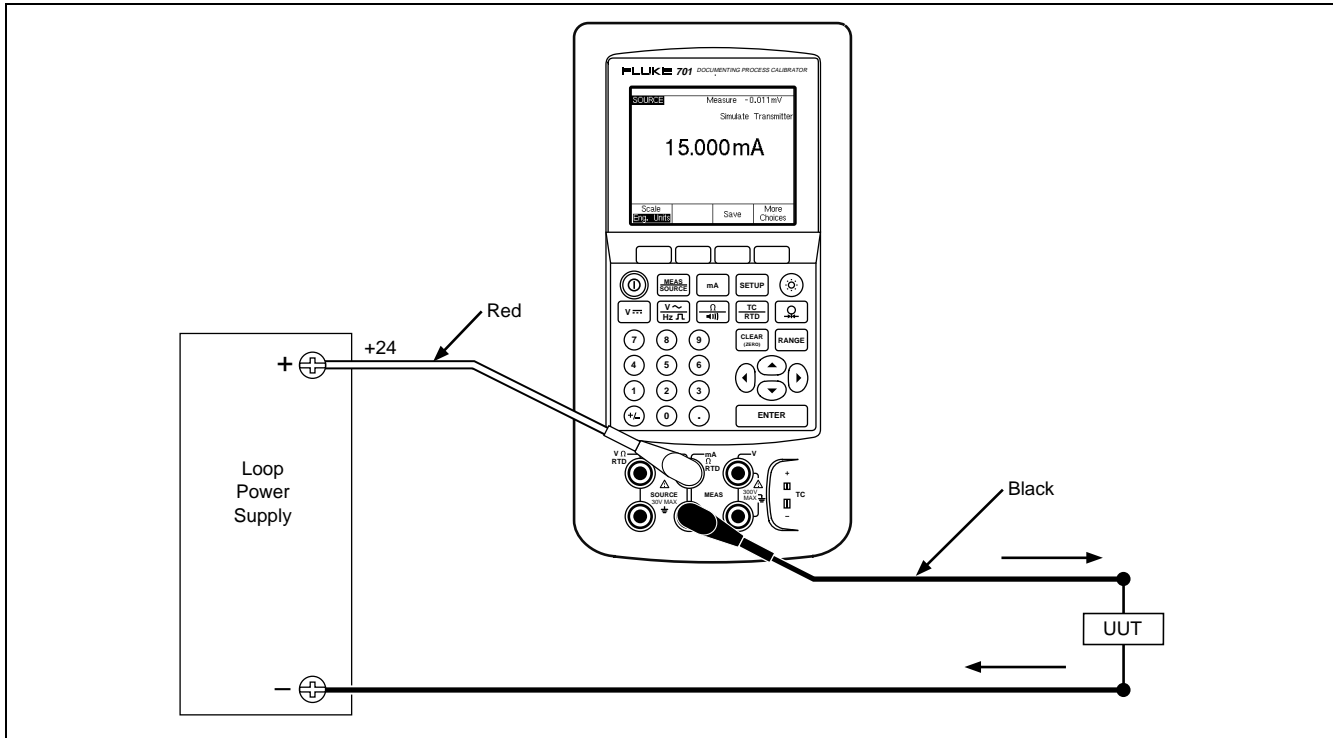

Figure 15. Connections for Simulating a 4 to 20 mA Transmitter

## **Providing Loop Power**

The calibrator provides loop power at 28V or 24V dc. The 28V setting provides enough current for two or three 4-20 mA devices on the loop in addition to the two-wire transmitter but uses more battery power. Use the 24V setting if there are two or fewer loads on the loop in addition to the two-wire transmitter. (Each device on a typical 4- to 20-mA loop has a resistance of 250 $\Omega$ , thus dropping 5V at 20 mA. A typical transmitter must have 11V minimum in order to operate correctly at its top end.)

When loop power is enabled, the mA (middle column) jacks are dedicated to sourcing and measuring the current loop. This means that the SOURCE mA, measure RTD, and measure and source  $\Omega$  functions are not available (see Table 8, later in this manual.)

Connect the calibrator in series with the instrument current loop as Figure 16 shows. Proceed as follows to source loop power:

1. Press  for  mode.
2. Note that following **Loop Power, Disabled** is highlighted. Press .
3. Use the  or  arrow keys to select **Enabled 24V** or **Enabled 28V**.
4. Press .
5. Press the **Done** softkey.

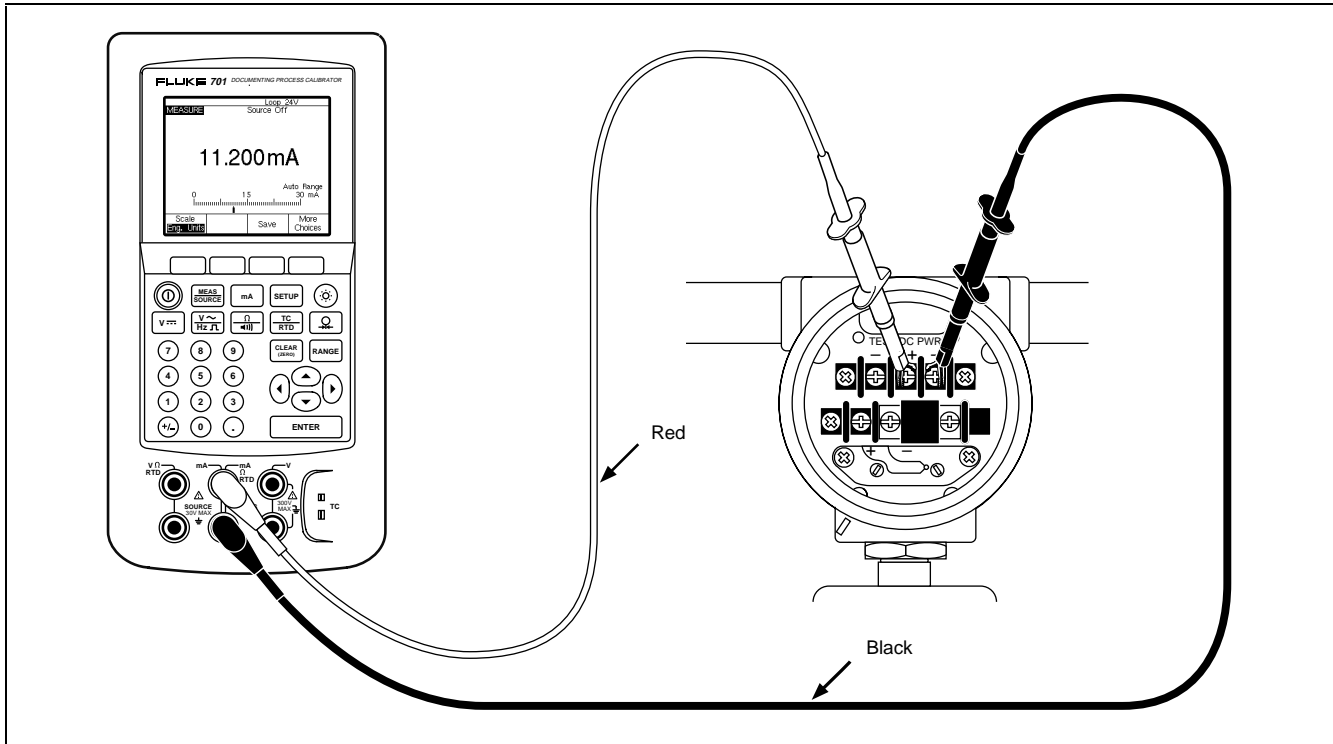

Figure 16. Connections for Supplying Loop Power



## **Sourcing Pressure**

The calibrator provides a source pressure display function that requires the use of an external pressure hand pump. Use this function to calibrate instruments that require a pressure source or differential pressure measurement. See Figure 31 for information about that application.

Pressure modules are available in gage or differential types, depending on range. (See “Accessories” near the front of this manual.) Gage pressure modules have one pressure fitting and measure the process pressure with respect to atmospheric pressure. Differential pressure modules have two pressure fittings and measure the difference between the pressure applied to the high fitting and the pressure applied to the low fitting. If the low fitting is left open, the pressure module acts as a gage unit.

To use the source pressure display, see Figure 17 and proceed as follows:

### **⚠ WARNING**









**TO AVOID A VIOLENT RELEASE OF PRESSURE IN A PRESSURIZED SYSTEM, SHUT OFF THE VALVE AND SLOWLY BLEED OFF THE PRESSURE BEFORE YOU ATTACH THE PRESSURE MODULE TO THE PRESSURE LINE.**

### **CAUTION**

**To avoid mechanically damaging the pressure module, never apply more than 10 ft.-lbs. of torque between the pressure module fittings or between the fittings and the body of the module. Always apply appropriate torque between the pressure module fitting and connecting fittings or adapters.**

**To avoid damaging the pressure module from overpressure, never apply pressure above the rated maximum printed on the pressure module.**

**To avoid damaging the pressure module from corrosion, use them only with specified materials. Refer to the pressure module instruction sheet for the specified material compatibility for your pressure module.**

1. Connect a pressure module and pressure source to the calibrator as Figure 17 shows. The threads on the pressure modules accept ¼ NPT fittings. Use the supplied ¼ NPT to ¼ ISO adapter if necessary.
2. If necessary, press  for SOURCE mode.
3. Press . The calibrator automatically senses which pressure module is attached and sets its range accordingly.
4. To zero the pressure module, vent the module to atmosphere, and press . Repeat this step until the reading is zeroed. You must perform this step before you execute a PMLink Task that sources pressure
5. Pressurize the pressure line with the pressure source to the desired level as shown on the display.
6. If necessary, you can change pressure display units to psi, mmHg, inHg, inH<sub>2</sub>O, ftH<sub>2</sub>O, bar, or kPa as follows:
  - a. Press .
  - b. Press **Next Page** twice.
  - c. Press  with the cursor on **Pressure Units**.
  - d. Select the pressure units with the  or  keys.
  - e. Press .
  - f. Press the **Done** softkey.

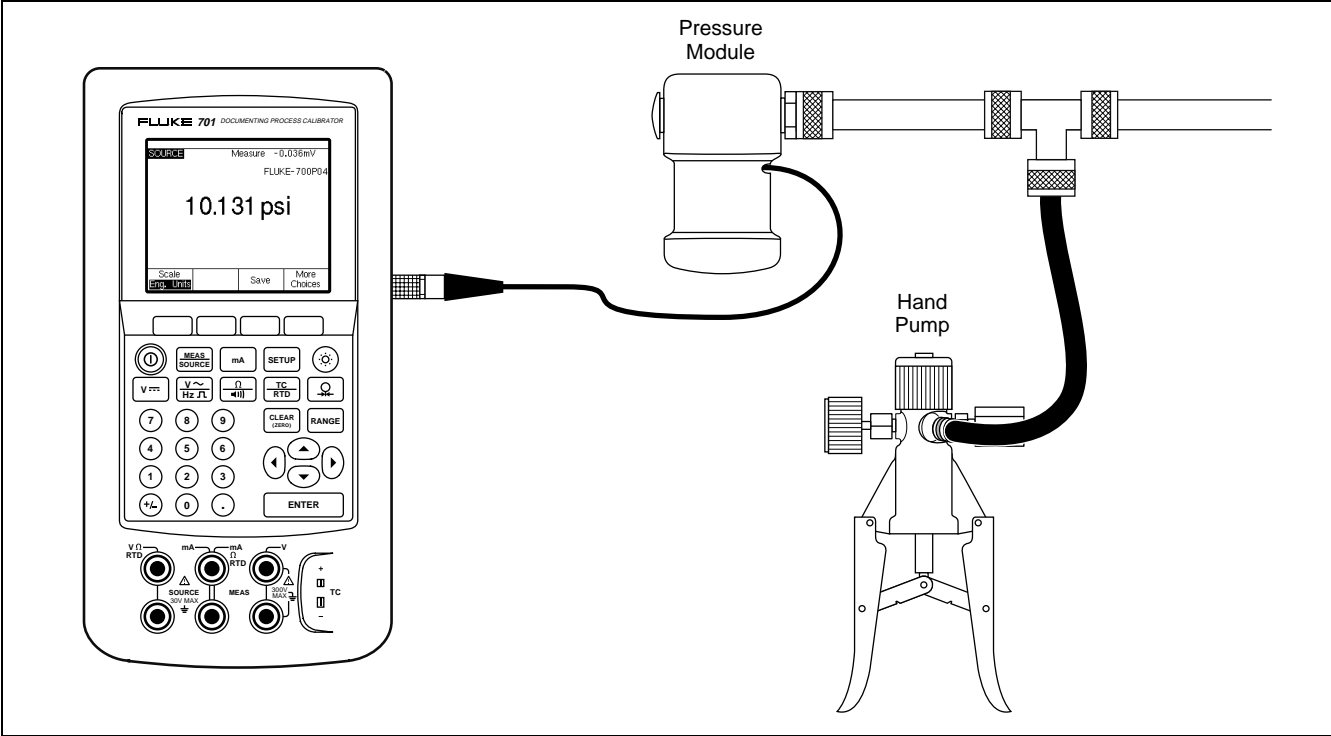

**Figure 17. Connections for Sourcing Pressure**





## Simulating Thermocouples

### NOTE

Refer to “Measuring Temperature” earlier in the manual for a table of data relating to thermocouple types supported by the calibrator.

Connect the calibrator TC connector to the instrument under test with thermocouple wire and the appropriate thermocouple mini-connector (polarized thermocouple plug with flat, in-line blades spaced 7.9 mm (0.312 in) center to center). *One pin is wider than the other. Do not try to force a miniplug in the wrong polarization.* Figure 18 shows this connection. Proceed as follows to simulate a thermocouple:

1. Attach the thermocouple leads to the appropriate TC miniplug, then to the TC jack as Figure 12 shows.
2. If necessary, press  for SOURCE mode.

3. Press  for the display that prompts you to enter thermocouple type.
4. Press the  or  key followed by  to select the desired thermocouple type.
5. Enter the temperature you want to simulate as prompted by the display and press .

### NOTE

If you use copper wire instead of thermocouple wire, the reference junction is no longer inside the calibrator. The reference junction is moved to the instrument (transmitter, indicator, controller, etc.) input terminals. You must measure this external reference temperature accurately and enter it into the calibrator. Do this by pressing  and setting **Ref. Junc. Compensat** and Ref. Junc. Temp. After you enter the external reference temperature, the calibrator corrects all voltages to compensate for this new reference junction temperature.

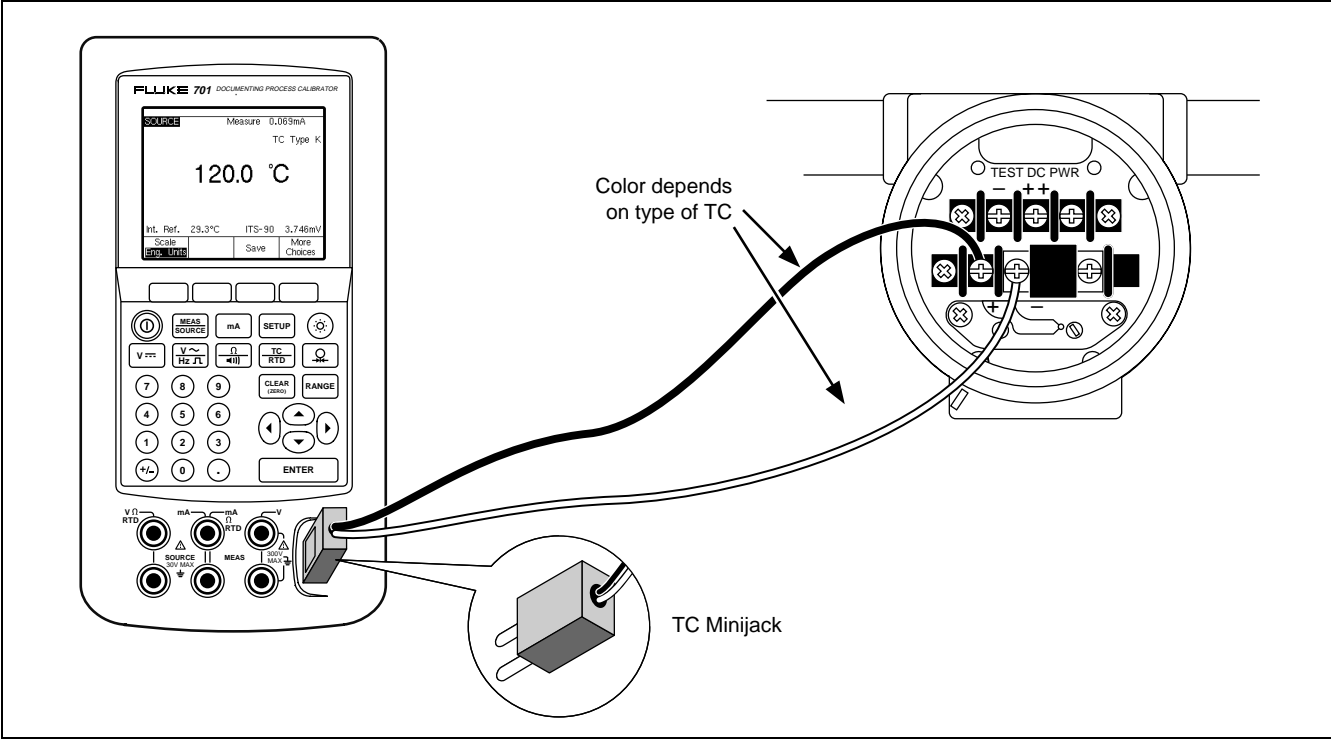







Figure 18. Connections for Simulating a Thermocouple

## Simulating RTDs

### NOTE

*Refer to Table 6 for information about RTD (Resistance Temperature Detector) types supported by the calibrator.*

Connect the calibrator to the instrument under test as shown in Figure 19. Proceed as follows to simulate an RTD (Resistance Temperature Detector):

1. If necessary, press  for SOURCE mode.
2. Press  until the select RTD type display is showing.
3. Press the  or  keys followed by  to select the desired RTD type.
4. Enter the temperature you want to simulate as prompted by the display, then press .

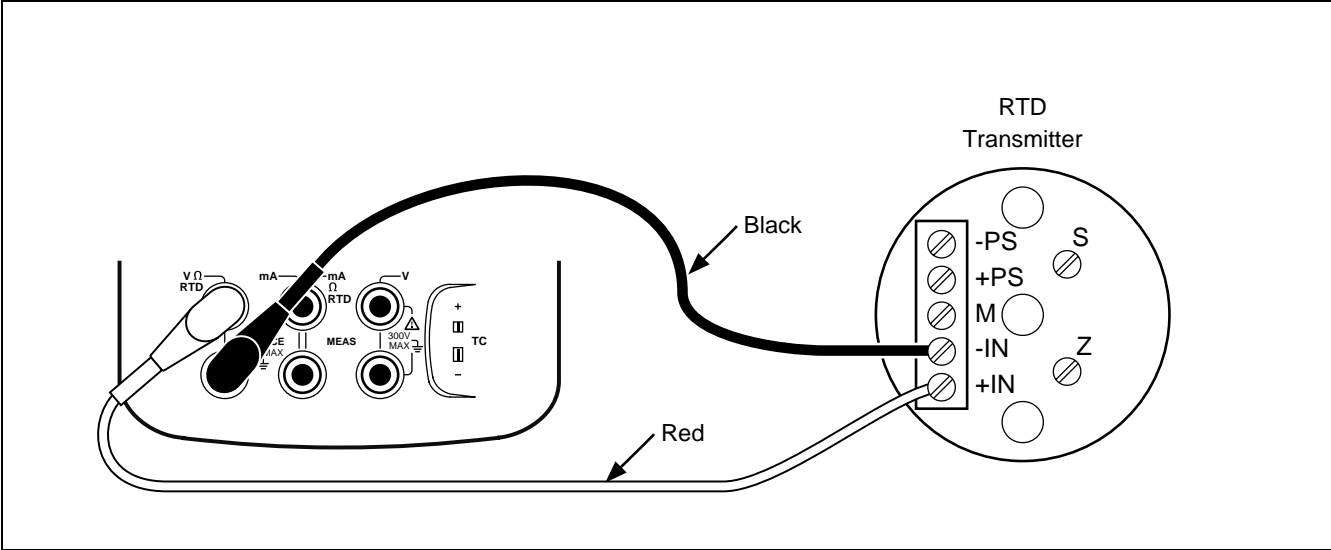

**Figure 19. Connections for Simulating an RTD**

## Sourcing in Percent of Scale

To adjust the source value as a percent of scale as shown below, proceed as follows:

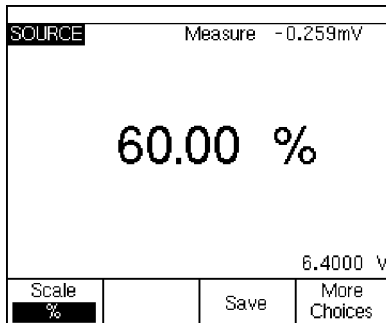

1. If necessary, press **MEAS SOURCE** for SOURCE mode.
2. Select a source function (**mA**, **V---**, **Ω**, **TC RTD**, or **Ω**) as previously described.
3. Press the **Scale** softkey.
4. Use the numeric keypad to enter the 0% of scale value.
5. Press **ENTER**.

6. Use the numeric keypad to enter the 100% of scale value.
7. Press **ENTER**.
8. Press the **Done** softkey.

Percent of scale remains in effect until you press the **Scale** softkey again.

## Stepping and Ramping the Output Value

Two special features are available for adjusting the value of source functions except pressure (sourcing pressure requires that you use an external pressure source):



- Stepping the output with the **▲** and **▼** keys.
- Ramping the output with optional continuity or V trip detect.

## Stepping the Output

The step feature allows you to select a step size in engineering units (mV, V, mA, °C, etc.) or % of scale. Stepping the output in % of scale is useful for quickly jumping between 0% and 100% (set step size = 100%) or 0-50-100% (set step size = 50%). Stepping



works in SOURCE and in MEASURE/SOURCE modes. Proceed as follows to select a step size:

1. Refer to the appropriate heading earlier in this manual (e.g., “Sourcing Electrical Parameters”) and connect the calibrator to the circuit to be tested.
2. If necessary, press  for SOURCE mode.
3. Set the calibrator for the desired source value.
4. If you want to step the source value in % of scale, set the % of scale value as described previously under “Sourcing in Percent of Scale.”
5. Press the **More Choices** softkey.
6. Press the **Step Size** softkey.
7. Use the numeric keypad to enter the step size in the units shown on the display.
8. Press the **Done** softkey.
9. Now you can adjust the output in steps by pressing the  and  keys.

## ***Ramping the Output***

Ramping is sweeping the source up or down in value. Use the ramp feature to check a limit switch or alarm, or any time you want a smoothly increasing or decreasing output function. You can set the calibrator to ramp up or down in engineering units (mV, V, mA, °C, etc.) or % of scale.

During ramping, the output is adjusted 4 times per second. The size of the steps is determined by your choices of endpoints and ramp time. For example, if you set the calibrator to ramp from 10 mV to 1V over 10 seconds, the output is adjusted in approximately 25 mV steps.

Ramping continues until the selected limit is reached, or until an optional trip condition is encountered. The optional trip detect works as follows: during ramping, the calibrator checks for either a 1V change in dc voltage or a change in continuity status (**Open** or **Short**) from one ¼ second interval to the next.

Proceed as follows to ramp (i.e., sweep the source):

1. Refer to the appropriate heading earlier in this manual (e.g., “Sourcing Electrical Parameters”)

and connect the calibrator to the circuit to be tested. Figure 20 shows an example.

2. If you want to automatically stop ramping if a trip condition is detected, connect a voltage trip circuit to the V MEAS jacks or a continuity trip circuit to the mA  $\Omega$  RTD MEAS jacks. (Continuity detection is not available when sourcing current.)
3. If necessary, press  for SOURCE mode.
4. Set the calibrator for the desired source value as previously described.
5. If you want to ramp the output in % of scale, set % of scale as described previously under "Sourcing in Percent of Scale."
6. Press the **More Choices** softkey.

7. Press the **Ramp** softkey. The display changes to the following:

SOURCE			
Enter Start Value			
Start Value	????????	%	
End Value	????????	%	
Ramp Time	?????	seconds	
Trip Detect	Disabled		
Trip Function	V DC		
Abort			Done

8. Fill in the parameters as prompted. Enter the **Start Value**, **End Value**, and **Ramp Time**.
9. If you want to automatically stop ramping if a trip condition is detected, set the **Trip Detect** to **Enabled**, and select **Voltage** or **Continuity** as the trip function.
10. Press the **Done** softkey. Note the **RAMP** annunciator next to **SOURCE** at the top of the display.
11. Select a low-to-high ramp or a high-to-low ramp with the **Ramp Up/Down** softkey.
12. To start ramping, press the **Start Ramp** softkey.
13. Ramping continues until a trip is detected (if enabled), the ramp time expires, or you press the **Stop Ramp** softkey.

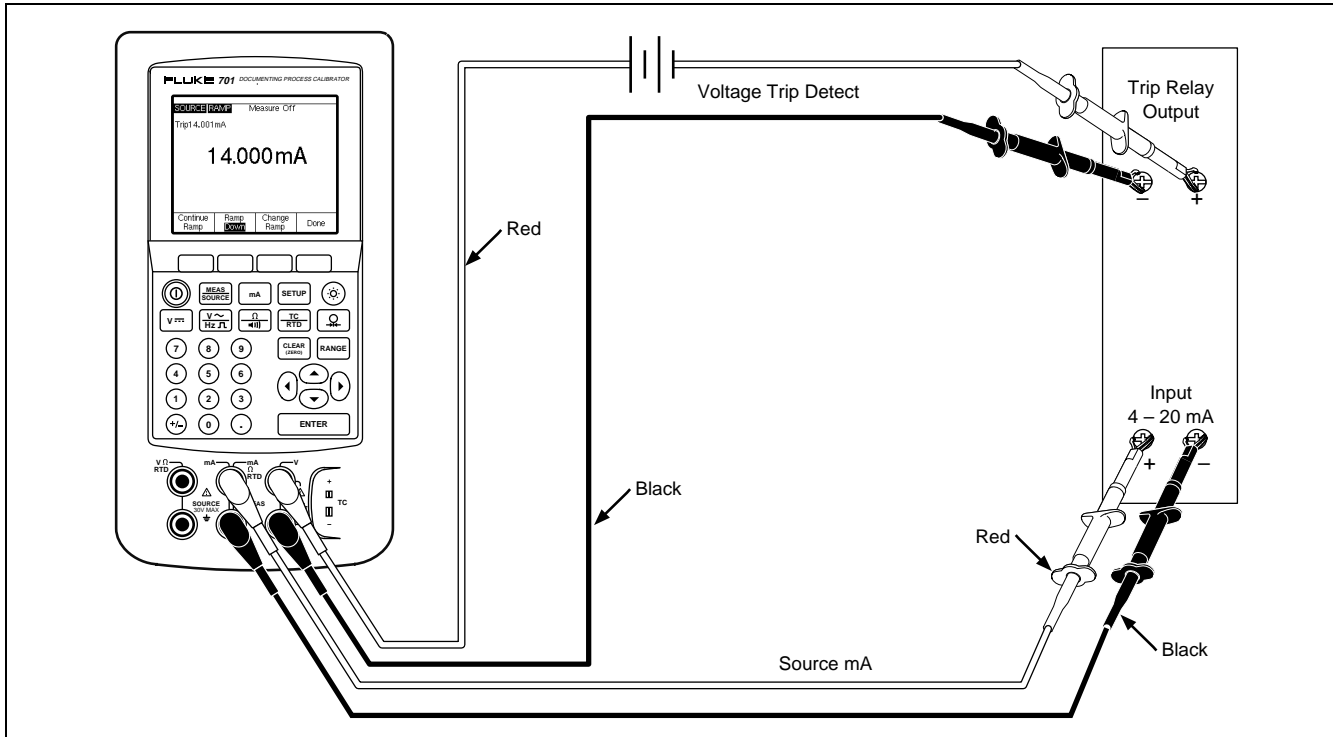



Figure 20. Checking a Relay Output Trip Alarm

## **Simultaneous Measure/Source**

Use MEASURE/SOURCE mode to calibrate process instruments. Press  so that the split screen display appears (see below).

MEASURE			
8.000 mA			
SOURCE		TC Type K	
150.0 °C			
Int. Ref.	27.4°C	ITS-90	5.041mV
As Found	Adjust	Save	More Choices

Table 7 shows the functions you can use simultaneously when Loop Power is disabled. Table 8 shows the functions you can use simultaneously when Loop Power is enabled.

You can use the step feature to adjust the output in MEASURE/SOURCE mode or you can use the calibration routine provided when you press the **As Found** softkey.

Table 7. Simultaneous MEASURE/SOURCE Functions with Loop Power Disabled

MEASURE FUNCTION	SOURCE FUNCTION						
	dc V	mA	Freq	$\Omega$	TC	2W RTD	Pressure
dc V	•	•	•	•	•	•	•
mA	•		•	•	•	•	•
ac V	•	•	•	•	•	•	•
Frequency ( $\geq 20$ Hz)	•	•	•	•	•	•	•
Low Frequency ( $< 20$ Hz)							
$\Omega$	•		•	•	•	•	•
Continuity	•		•	•	•	•	•
TC	•	•	•	•		•	•
2W RTD	•		•	•	•	•	•
3W RTD	•		•	•	•	•	•
4W RTD	•		•	•	•	•	•
Pressure	•	•	•	•	•	•	

**Table 8. Simultaneous MEASURE/SOURCE Functions with Loop Power Enabled**

MEASURE FUNCTION	SOURCE FUNCTION						
	dc V	mA	Freq	$\Omega$	TC	2W RTD	Pressure
dc V	•		•	•	•	•	•
mA	•		•	•	•	•	•
ac V	•		•	•	•	•	•
Frequency ( $\geq 20$ Hz)	•		•	•	•	•	•
TC	•		•	•		•	•
Pressure	•		•	•	•	•	

The two softkeys displayed in MEASURE/SOURCE mode are for use in calibrating a process instrument. Instructions for calibrating a process instrument are provided next.

- **As Found**, which starts up a calibration routine to obtain and record as found data.
- **Adjust**, for making adjustments to a transmitter if required.









## Calibrating a Process Instrument

When the calibrator is in simultaneous MEASURE/SOURCE mode, a built-in calibration routine is activated when you press the **As Found** softkey. (As Found data are the test results showing the condition of a transmitter before it is calibrated.) Additionally, Model 702 runs procedures developed using *PMLink* software. To use procedures from *PMLink* software, see the *PMLink* manual.

### Generating “As Found” Test Data

The following example shows how to generate *as found* data for a thermocouple temperature transmitter. In this case the calibrator is simulating the output of a thermocouple and measuring the resulting current from the transmitter. Other transmitters use this same method. Just go back to MEASUREMENT or SOURCE mode and change the operating parameters before you press **As Found**.

1. Connect the test leads to the instrument under test as shown in Figure 21. The connections simulate a thermocouple and measure the corresponding output current.

2. If necessary, press  for MEASURE mode.
3. Press .
4. Press  for SOURCE mode.
5. Press .
6. Use the  and  keys to select the thermocouple type, then press .
7. Enter a source value, for example 100°, then .
8. Press  for MEASURE/SOURCE mode. The display changes as follows:

MEASURE			
8.000 mA			
SOURCE		TC Type K	
150.0 °C			
Int. Ref.	27.4°C	ITS-90	5.041 mV
As Found	Adjust	Save	More Choices



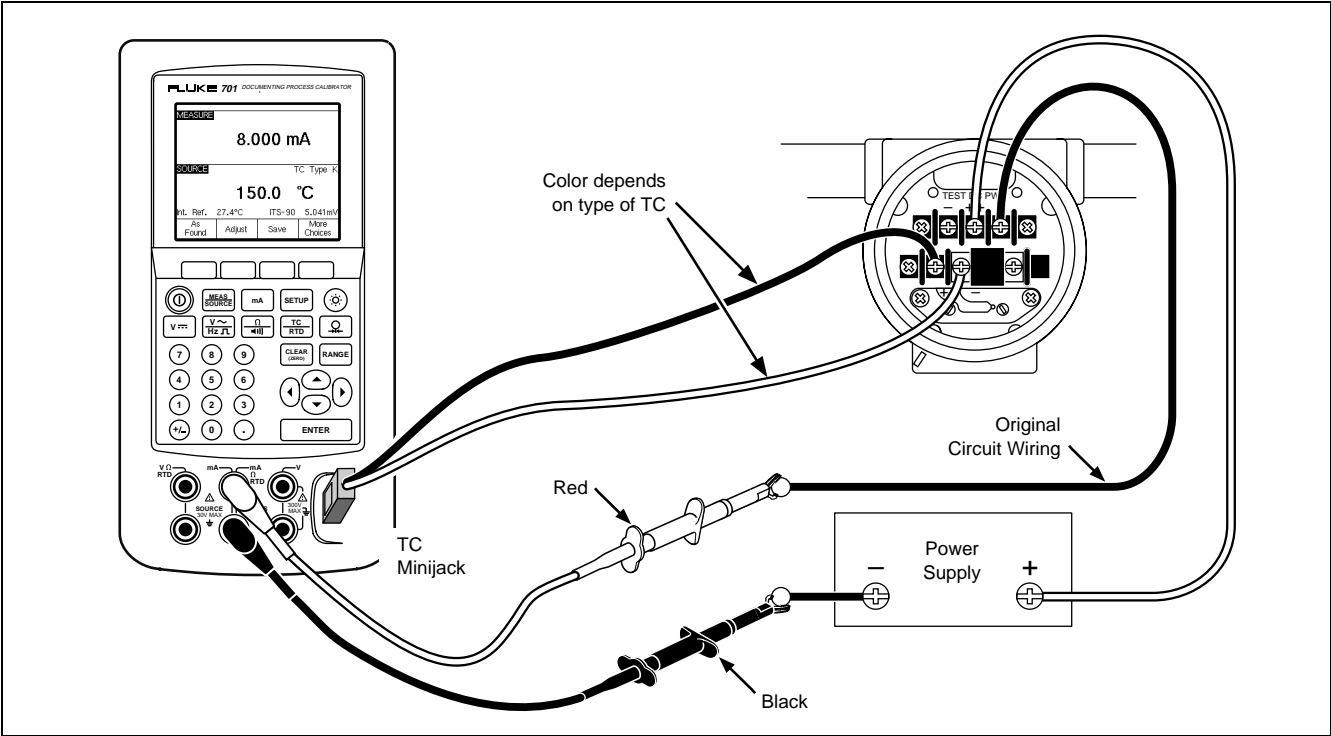

**Figure 21. Calibrating a Thermocouple Temperature Transmitter**

9. Press the **As Found** softkey. The display changes as follows:

<b>MEASURE</b>			
0% Value	????????	mA	
100% Value	????????	mA	
Tolerance	????????	%	
User-Entered Value	Disabled		
<b>SOURCE</b>			
		TC Type	K
0% Value	????????	°C	
100% Value	????????	°C	
Test Strategy	3	↑	
Abort			Done

10. Enter values for **0%** and **100%** of 4.0 mA and 20.0 mA, respectively. Set **Tolerance** to 0.5% of span. (Use other values if necessary for your application.)

**User Entered Value** is for a value measured by some other device, such as the reading reported by the control room. Leave this set to *Disabled* because you are only interested in values measured at the transmitter output.

#### NOTE

*If you set **User-Entered Value** to **Enabled**, you will be prompted to enter a value at each test point in the measured units. Errors will be calculated and displayed based on the user-entered value, not the measured value.*

11. Use the arrow keys to move the cursor down to enter **0%** and **100%** values for SOURCE temperature. Our example uses 100°C and 300°C.
12. The **Test Strategy** is the number of test points and which test points are performed rising and falling in percent of scale. Our example uses five points (0%, 25%, 50%, 75%, and 100%), rising only. Rising is indicated by the up arrow on the display. Change to another test strategy by pressing  on this line. A list of strategies appears from which to choose. Select one, then press **Done**. When you finish selecting the calibration parameters, the display appears as follows:

<b>MEASURE</b>			
0% Value	4.000 mA		
100% Value	20.000 mA		
Tolerance	0.50 %		
User-Entered Value	Disabled		
<b>SOURCE</b>		TC Type K	
0% Value	100.0 °C		
100% Value	300.0 °C		
Test Strategy	5 ↑		
Abort			Done

13. Press the **Done** softkey to accept the calibration parameters. The display changes as follows:

<b>MEASURE</b>			
Error	0.07 %		
<b>4.011 mA</b>			
<b>SOURCE</b>		TC Type K	
<b>100.0 °C</b>			
Int. Ref.	27.0°C	ITS-90	3.015mV
Abort	Auto Test	Manual Test	

14. You now have the choice of starting an automatic test or stepping through the test points manually. Press the **Auto Test** softkey to have the calibrator run through the tests automatically. (**Abort** gets you out of the calibration procedure.) The tests begin at the zero point, sourcing the correct temperature (a voltage) and measuring the corresponding current from the transmitter. As soon as a measurement has settled and has been captured, the calibrator moves on to the next step. Because the calibrator waits for the measurement to stop changing, the Auto Test works correctly for instruments with built-in damping. The error of the expected measured

value is shown in the top left of the measure window.

15. The calibrator moves on to the remaining set of points. For temperature and electrical parameter calibration, the points are done automatically. If you are sourcing pressure, the calibrator pauses at each step for you to adjust the pressure source. When the tests are complete, an error summary table, such as the following is displayed.

SOURCE	MEASURE	ERROR %
100.0 °C	3.904mA	-0.60
150.0 °C	7.965mA	-0.22
200.0 °C	12.053mA	0.33
250.0 °C	16.094mA	0.59
300.0 °C	20.175mA	1.09

Abort	Prev. Page	Next Page	Done
-------	------------	-----------	------

16. In the results summary test, failures are highlighted. An adjustment is required in this example because three tests show failures. The

failures were outside the  $\pm 0.5\%$  tolerance that we selected.

17. Either press the **Done** softkey to save the data, or the **Abort** softkey to delete the data and start over. You have to go back to **As Found** to restart the calibration. You can see the saved data entry and recall the table for later viewing through the **Review Memory** softkey during normal operation. With Model 702 you can upload this data to a PC using PMLink software. See the *PMLink Manual* for instructions.

### Adjusting the Transmitter

Proceed as follows to make the calibration adjustments to the transmitter. (Always refer to the transmitter manufacturer's instructions to locate the adjustment controls and connection points for your transmitter).

1. Press the **Done** softkey while viewing the results summary.
2. Press the **Adjust** softkey. The calibrator sources 0% of span (100°C in this example) and displays the following softkeys:

- Go to 100%/Go to 0%
  - Go to 50%
  - As Left
  - Exit Cal
3. Adjust the transmitter output for 4 mA then press the Go to 100% softkey.
  4. Adjust the transmitter output for 20 mA.
  5. If the span was adjusted in step 4, you must go back and repeat steps 3 and 4 until no more adjustment is required.
  6. Now check the transmitter at 50%. If it is within specification, your adjustment is complete. If not, adjust the linearity and begin this procedure again at step 3.

### “As Left” Test Run

Proceed as follows to generate and record *as left* data for the thermocouple temperature transmitter you have just adjusted.

1. Press the **As Left** softkey to record *as left* data.

2. Press the **Auto Test** softkey to begin an automatic sequence through all the test points, or you can step through the tests manually.
3. When the tests are complete, observe the error summary table, such as the following.

SOURCE	MEASURE	ERROR %
100.0°C	3.966 mA	-0.21
150.0°C	7.991 mA	-0.05
200.0°C	12.029 mA	0.18
250.0°C	* 16.023 mA	0.14
300.0°C	19.983 mA	-0.10

Abort	Prev. Page	Next Page	Done
-------	------------	-----------	------

An asterisk (\*) next to a measure or source value indicates an unsettled value (~) annunciator when the measurement was taken.

4. If all the results are within specification, as they are this time, press the **Done** softkey. An entry in memory is made for *as left* data.

## Memory Operations

### Saving Results

As Found/As Left test results are automatically saved at the end of each test routine. Any other time during MEASURE, SOURCE, or MEASURE/SOURCE you can press the **Save** softkey to save the data on the display for later review.

After you press **Save**, the calibrator saves the information on the display and shows a saved result index number, the date and time, and the cumulative percentage of memory used, as in the following display:

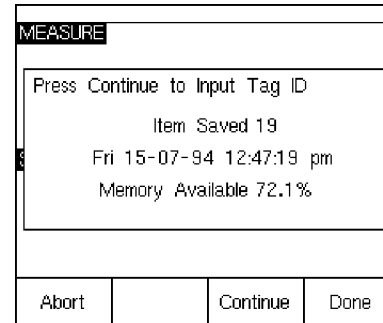



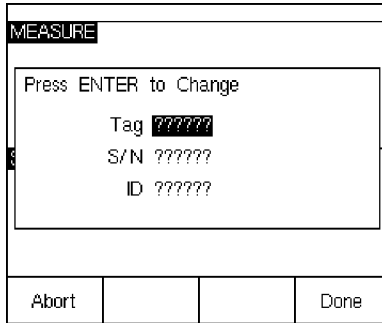

You can quit at this point. Or, if you want to add information to the saved data, the calibrator has a way for you to do so. If you press the **Continue** softkey, the display prompts you to enter the instrument tag identifier (**Tag**), instrument serial number (**Ser#**), and operator name (**ID**), as shown in the following display:

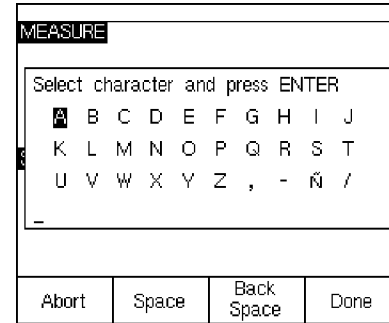

Enter alphanumeric data by pressing  with the cursor on the field you would like to change (for example, Tag, above). The display presents you with an alphanumeric entry window as follows:



1. Enter numbers with the numeric keypad.
2. Enter letters or a space character by highlighting the desired character with the , , , and  keys and pressing .
3. When the entry showing at the bottom of the window is what you want, press the **Done** softkey.

### **Reviewing Memory**

Press the **More Choices** softkey twice, then press the **Review Memory** softkey to recall and view saved results.

When you press the **Review Memory** softkey, the display changes to the following:

Results From 07/06/94		1 of 12	
Measure	04:10:05	pm	
Measure	04:24:46	pm	
Measure	04:24:53	pm	
Measure Source	04:25:35	pm	
As Found	04:25:35	pm	
Tag ID	04:26:10	pm	
Source	04:27:01	pm	
Measure Source	04:27:09	pm	
Measure	04:27:18	pm	
Measure Source	04:27:47	pm	
Go To Result	Prev. Page	Next Page	Done

Press  to view a saved result.w

### Data Logging (Model 702 Only)

Data logging (702 only) With Model 702 only, you can record a series of measurements for later uploading to a PC with PMLink software. You can log up to 8000 readings, depending on the reading rate, duration, and how much memory is being used for other things such as tasks or saved results. You enter the reading rate and duration in minutes as shown next.

MEASURE	
Press ENTER to Change	
Reading Rate	<input type="text" value="20"/> /min
Duration	10 minutes
Number of Points	200
Memory Available	28.6%
Abort	Done

Proceed as follows to log data:

1. If necessary, press  for MEASURE mode.
2. Press the **More Choices** softkey.
3. Press the **Log** softkey.
4. A list appears from which you select a reading rate (1, 2, 5, 10, 20, 30, or 60 readings per minute). Use the  or  key to select the reading rate.
5. Press .
6. Press  to move the cursor to **Duration**.



7. Use the numeric keypad to enter the duration in minutes, followed by . The maximum duration will depend on the reading rate and how much memory is available to log data. The table below gives an estimate of the limits for duration, assuming that no memory is being used for other purposes:

READING RATE (Readings/Minute)	MAX. NUMBER OF READINGS	MAX. DURATION
1	999	16 hours
2	1998	16 hours
5	4995	16 hours
10	8000	13 hours
20	8000	6 hours
30	8000	4 hours
60	8000	2 hours

### CAUTION

**A long logging duration can exceed the life of a battery charge. Use a fresh battery and the appropriate duration, or use the optional battery eliminator to avoid losing power during a logging session. If  appears during a log session, the session is terminated and data collected to that point is saved.**

8. After you enter your choice of duration, you can see the how much memory that duration would consume. See the **Memory Used** and **Memory Remaining** percentage figures on the display. **Memory Used** indicates the percentage of available memory that will be used by the specified log. **Memory Remaining** indicates the percentage of memory that will remain unused after logging is complete.

9. Press the **Done** softkey. The display changes to the following:

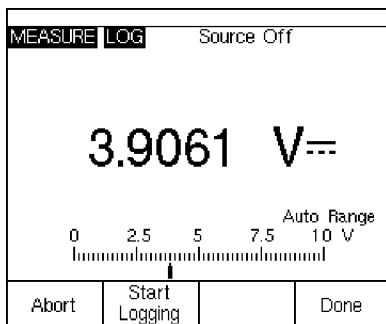

10. Note the **LOG** annunciator next to **MEASURE**. Press the **Start Logging** softkey to start taking data.
11. The calibrator will continue storing data points until the duration has elapsed, or until you press the **Stop Logging** softkey. Either way of terminating logging causes the calibrator to save the data as a memory item that can be uploaded to a PC with PMLink software.

## Observing Min and Max Measurements

You can set the display to record and show the maximum and minimum readings. Min and Max readings are always undamped, even if Dampen is On. Press the **More Choices** softkey twice, then press the **Min Max** softkey to turn on this feature. Press the **CLEAR (ZERO)** key to reset the Min Max registers. Press the **Min Max** softkey again to revert to the normal display. The following figure shows the display with Min Max on:

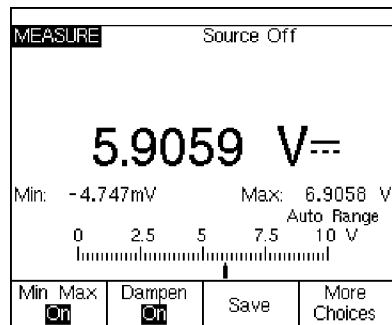

## Viewing the Task List (Model 702 Only)

Press the **More Choices** softkey until the **Tasks** softkey appear, then press **More Choices** to view

the list of tasks (procedures) downloaded from PMLink. Tasks are 702 calibrator configurations, saved with a procedure name, for example the type and manufacturer of a specific transmitter. A procedure configures the calibrator for transmitter calibration with all the calibration parameters (SOURCE/MEASURE functions, 0% and 100% levels, test strategy) predefined. See the *PMLink* manual for instructions on developing and downloading tasks.

### ***Clearing Memory***

The **Clear Memory** softkey, shown after you press **More Choices** softkey three times, clears all the memory:

- Saved results
- Min Max data
- Log data sets (Model 702 only)

A confirmation message appears so that you do not inadvertently erase the memory.

### ***Quick Guide to Applications***

The following figures show test lead connections and which calibrator function to use for many different applications.

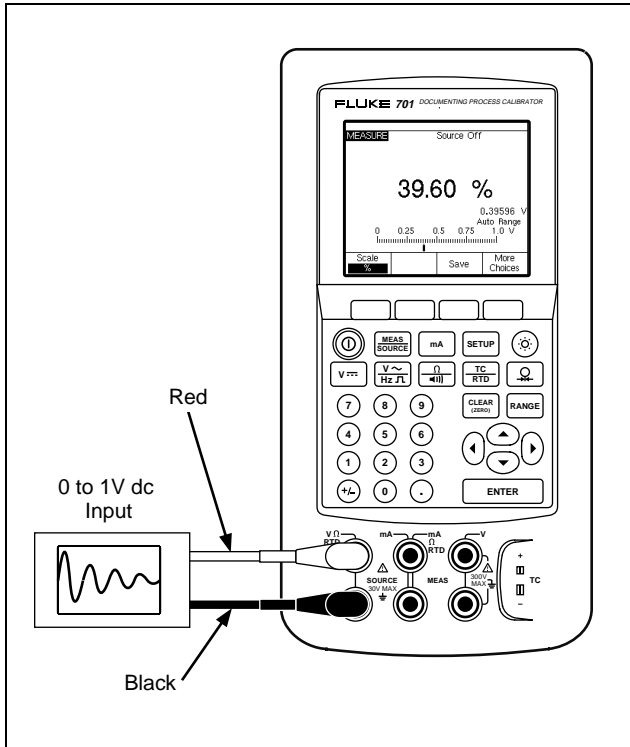

Figure 22. Calibrating a Chart Recorder

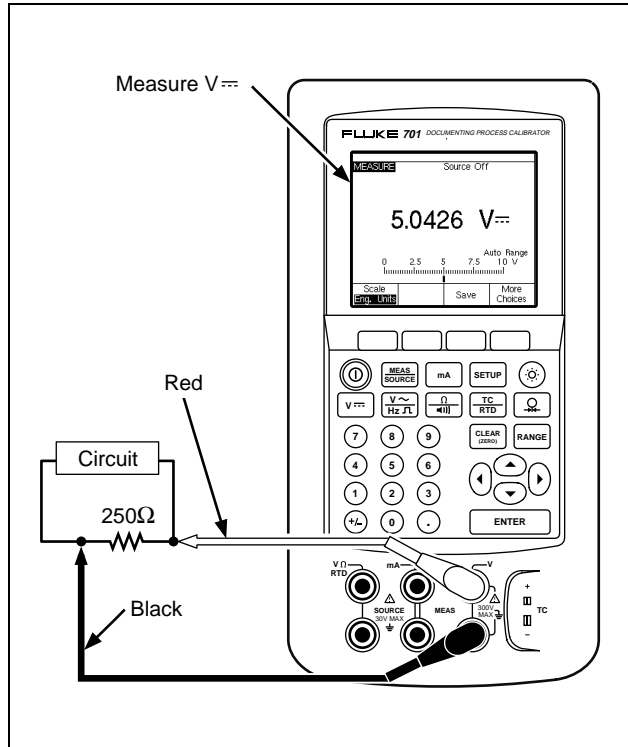
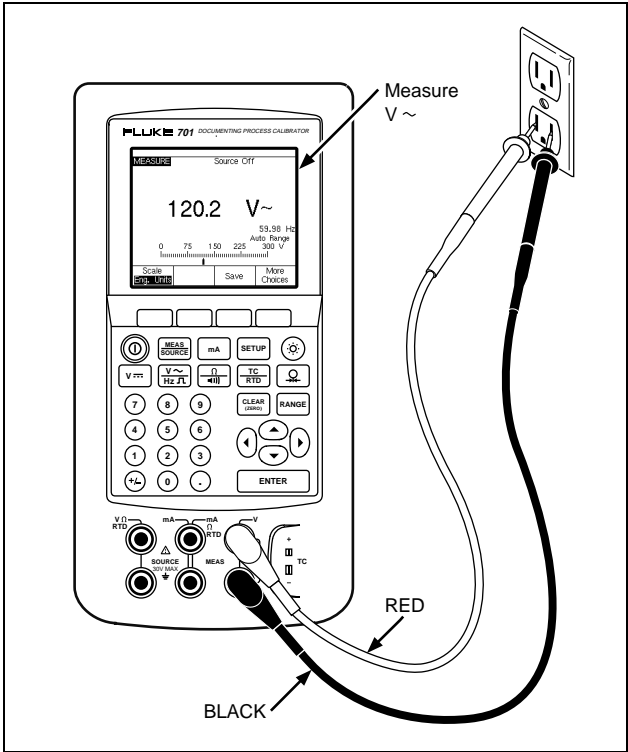

Figure 23. Measuring Voltage Drop



**Figure 24. Monitoring AC Line Voltage and Frequency**

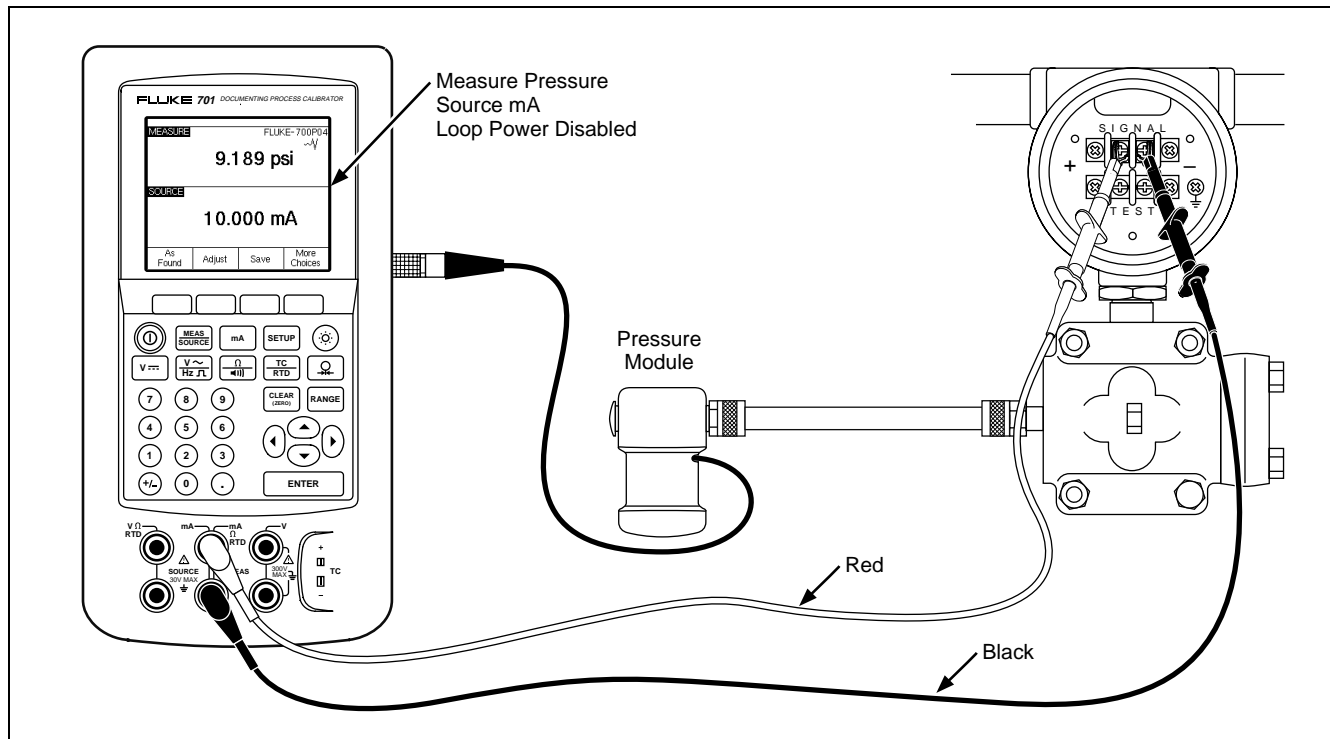
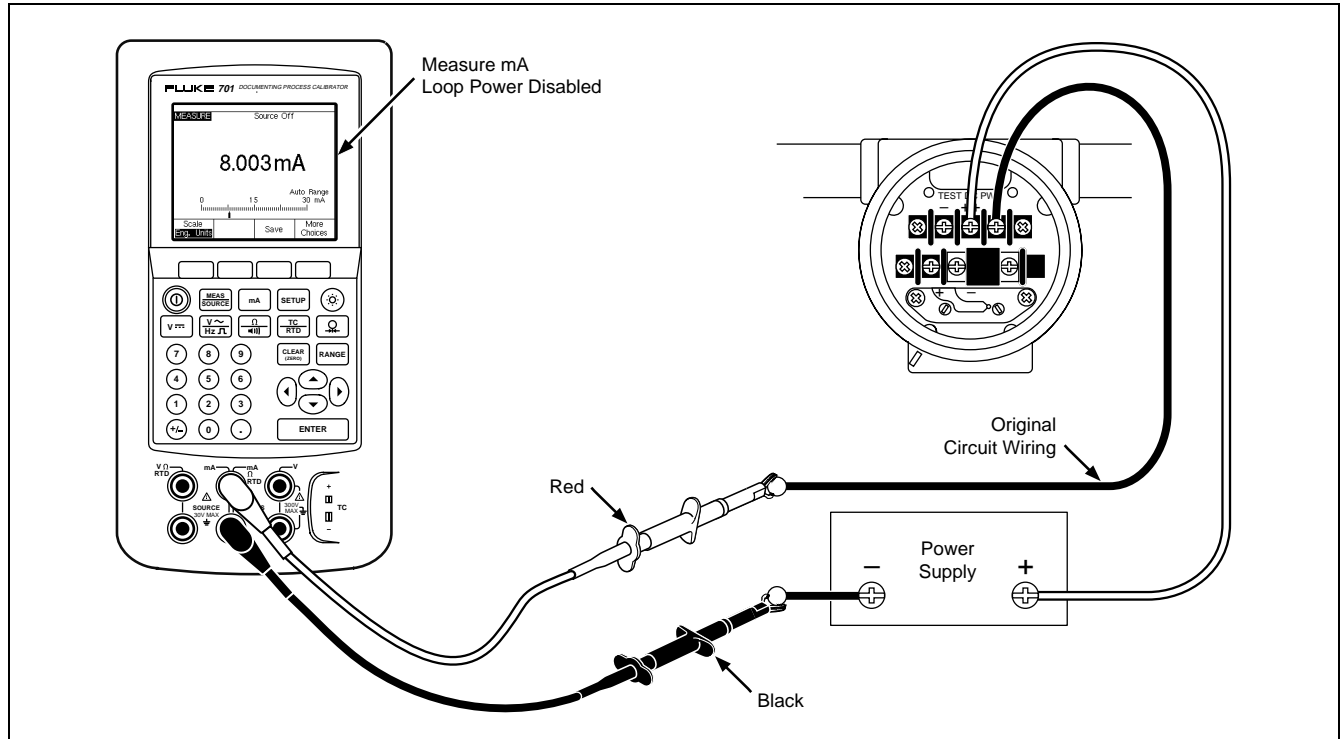

Figure 25. Calibrating a Current-to-Pressure (I/P) Transducer



**Figure 26. Measuring the Output Current of a Transmitter**

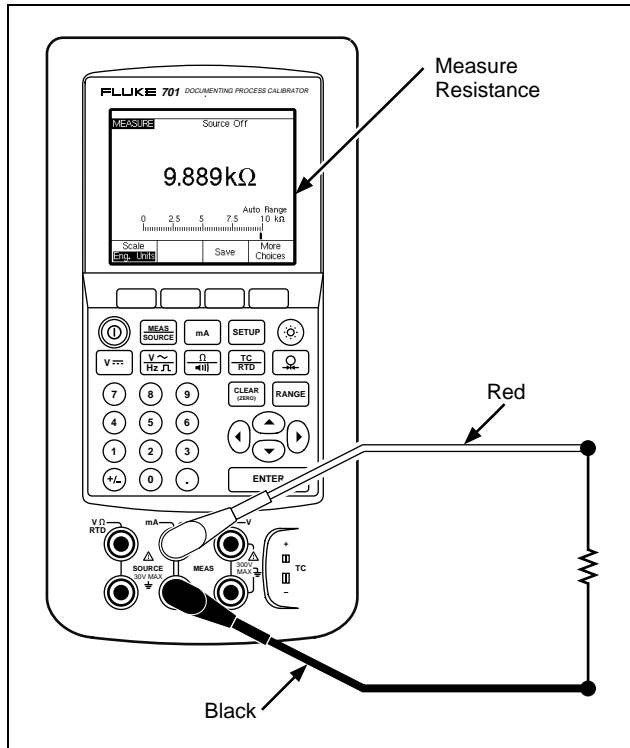

Figure 27. Measuring a Precision Resistor

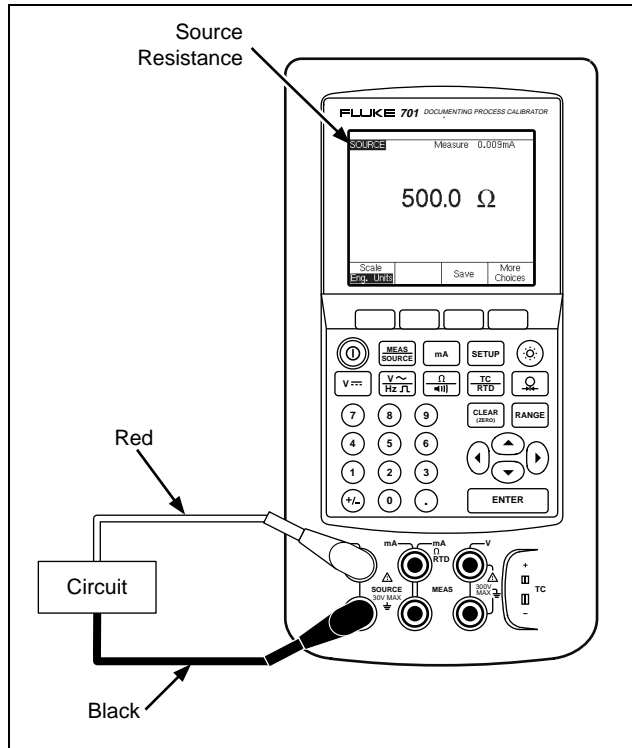
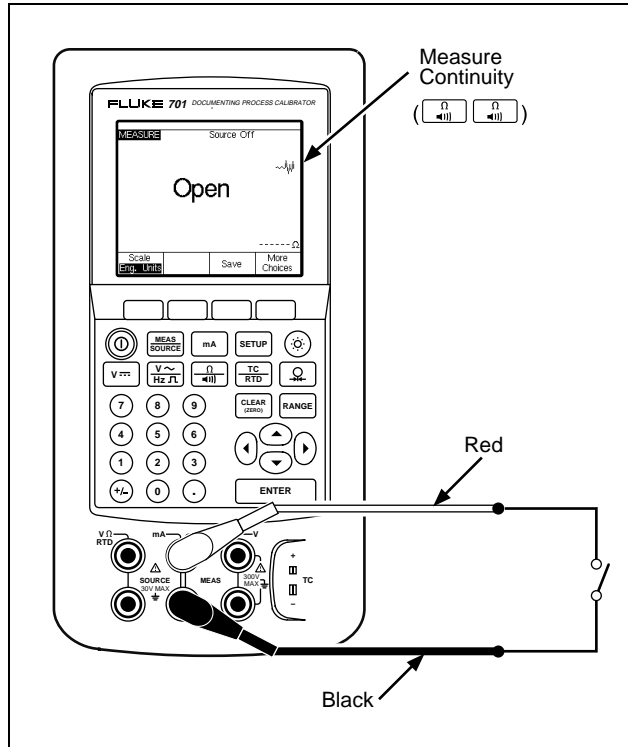
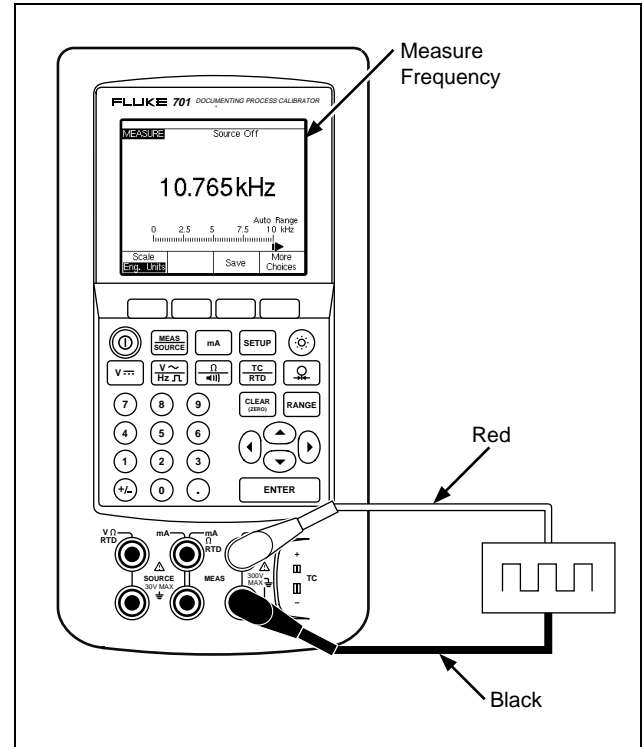

Figure 28. Sourcing Resistance





**Figure 29. Checking a Switch**



**Figure 30. Checking a Tachometer**

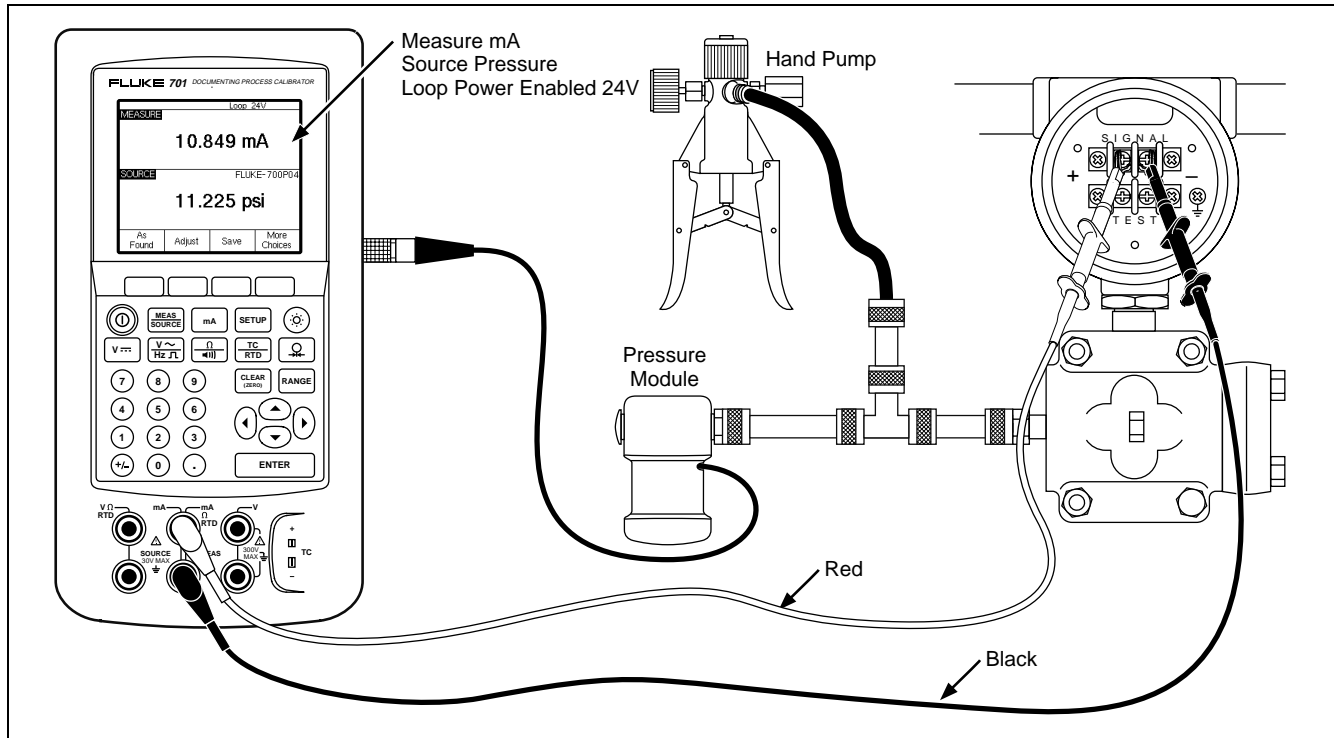
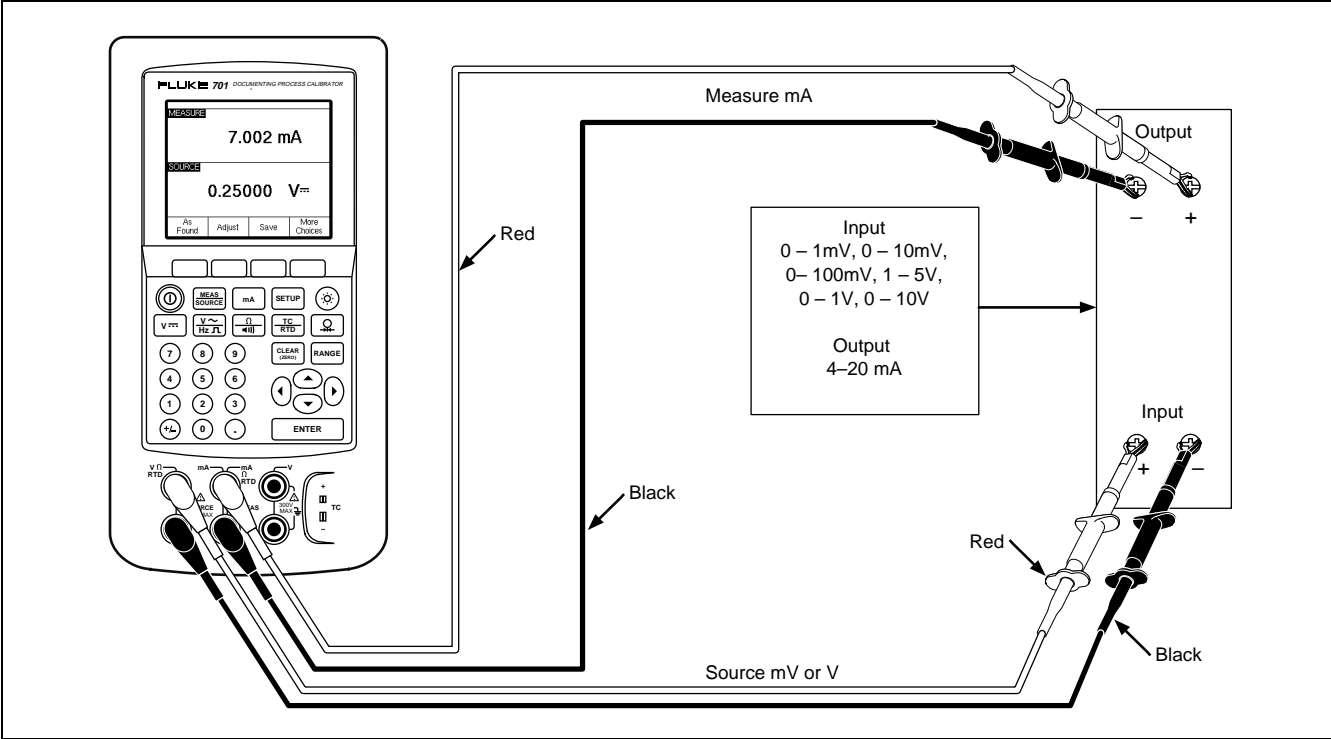

Figure 31. Calibrating a Pressure-to-Current (P/I) Transducer



**Figure 32. Calibrating a mV to Current Transmitter**

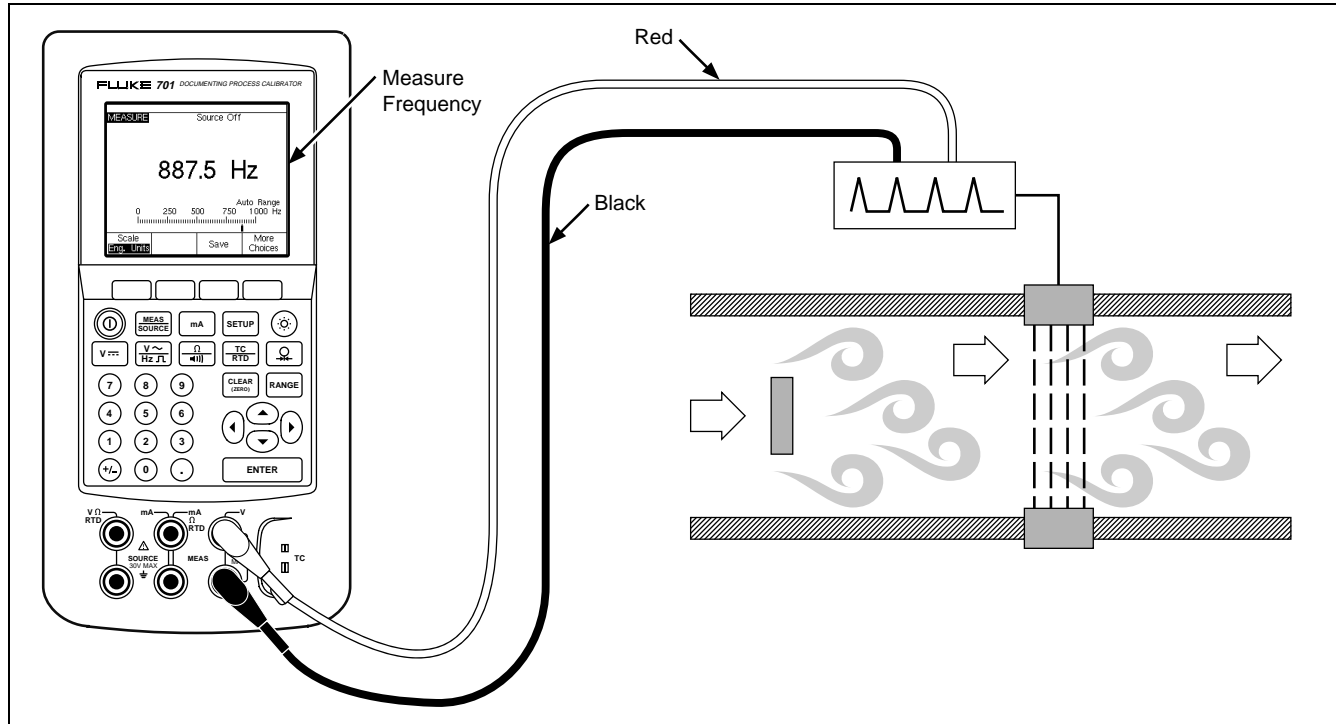

Figure 33. Checking a Vortex Shedding Flowmeter

## **Communicating with a PC (Model 702 Only)**

You can upload and download procedures and saved results to a PC. An IBM PC™-compatible personal computer, Microsoft Windows 3.1, and Fluke *PMLink* software are required. A custom serial interface cable for the 702 is included with *PMLink*. Refer to the *PMLink* Manual for further instructions.

## **Maintenance**

### *NOTE*

*Additional maintenance instructions including a calibration procedure, full parts list, and schematic diagrams are available in the 701/702 Service Manual, PN 944525.*

## **Replacing the Battery Pack**

Replace the battery pack when it no longer holds a charge for the rated interval. The battery normally lasts for up to 1000 charge/discharge cycles. To order a replacement battery, order Model BP7217 Nickel-Cadmium Battery Pack. In the USA and

Canada call Fluke Service Parts at (800) 526-4731. Outside the USA and Canada call +1 206-356-5500 to receive instructions.



Do not mix spent Nickel-Cadmium batteries with the solid waste stream. Spent batteries should be disposed of by a qualified recycler or hazardous materials handler. Contact your authorized Fluke Service Center for recycling information.

## **Internal Lithium Backup Battery**

A lithium battery maintains the memory contents and **SETUP** settings. The normal service life for the lithium battery is 3 to 5 years.

You cannot access the lithium battery. Return the calibrator to an authorized Fluke service center listed at the back of the manual if you need to replace the lithium battery. When the lithium battery is 3 years old, replace it at the next calibration interval as a preventive maintenance procedure.

## **Cleaning the Calibrator**

Clean the calibrator and pressure modules with a soft cloth dampened with water or water and mild soap.

### **CAUTION**

**To avoid damaging the plastic lens and case, do not use solvents or abrasive cleansers.**

### ***Calibration Data***

The date of last calibration shows on the calibration sticker and on the last screen in **SETUP** mode. The CAL. STATUS number on the sticker should always match the Calibration Status number in the calibration **SETUP** screen. Calibration of the 701 and 702 is to be done by qualified personnel.

### ***Service Center Calibration or Repair***

Calibration, repairs, or servicing not covered in this manual should be performed only at an authorized Fluke Service Center. If the calibrator fails, check the nickel-cadmium battery pack first, and replace it if needed.

Verify that the calibrator is being operated in accordance with the instructions in this manual. If the calibrator is faulty, send a description of the failure with the calibrator. Pressure modules do not need to accompany the calibrator unless the module is faulty

also. Be sure to pack the calibrator securely, using the original shipping container if it is available. Send the equipment postage paid and insured, to the nearest Service Center. (Refer to the list of Service Centers which follows.) Fluke assumes no responsibility for damage in transit.

A Fluke 701 or 702 calibrator covered by the warranty will be promptly repaired or replaced (at Fluke's option) and returned to you at no charge. See the back of the title page for warranty terms. If the warranty period has expired, the calibrator will be repaired and returned for a fixed fee. If the calibrator or pressure module is not covered under the warranty terms, contact one of the Fluke Service Centers listed at the back of this manual for a price quote for repair.

### ***Replacement Parts***

Table 9 lists the user-replaceable parts for the Model 701 and 702. If the item has a Fluke Model Number, order it by that number. Otherwise, use the Fluke Part Number.

**Table 9. Replacement Parts**

Item	Part Number	Model Number
Industrial Test Leads	---	TL24
Test Clips	---	AC20
Test Probes	---	TP20
Rechargeable Nickel-Cadmium Battery Pack	---	BP7217
Battery Charger	---	BC7210
Adjustable Quick-Release Strap	946769	---
Jumper for Three-Wire RTD Measurement Connections	944632	---
Rubber Side Plug	938274	---
Battery Door	938357	
Bail	938340	
Bail Screw	943431	
Case Screw	942797	
Lens for Model 701	938217	
Lens for Model 702	938212	
Input/Output Jack Decal	946756	
701/702 Users Manual	943993	---
701/702 Quick Reference Guide (Set)	942784	
Battery Eliminator	---	BE9005
Service Kit	---	926113

## **Specifications**

All specifications apply from +18°C to +28°C unless stated otherwise.

All specifications assume a 5 minute warmup period.

Measurement specifications are valid only when Damping is turned on. When damping is turned off, or when the  annunciator is displayed, floor specifications are multiplied by 3. Floor specifications are the second part of the specifications, usually expressed as "% of full scale." The measure pressure, temperature, and frequency functions are specified only with damping on.

The standard specification intervals for the 701 and 702 are 1 and 2 years. Typical 90-day source and measurement accuracy can be estimated by dividing the 1 year "% of Reading" or "% of Output" specifications by 2. Floor specifications, expressed as "% of f.s.", remain constant.

### **NOTE**

*To achieve best measurement noise and accuracy performance, do not use the battery eliminator, and tie all three common jacks together.*



### **DC Voltage Measurement**

RANGE	RESOLUTION	MODEL 702		MODEL 701	
		% OF READING +% OF FULL SCALE		% OF READING +% OF FULL SCALE	
		1 YEAR	2 YEAR	1 YEAR	2 YEAR
110 mV	1 $\mu$ V	0.025% + 0.015%	0.05% + 0.015%	0.05% + 0.015%	0.1% + 0.015%
1.1 V	10 $\mu$ V	0.025% + 0.005%	0.05% + 0.005%	0.05% + 0.005%	0.1% + 0.005%
11 V	100 $\mu$ V	0.025% + 0.005%	0.05% + 0.005%	0.05% + 0.005%	0.1% + 0.005%
110 V	1 mV	0.05% + 0.005%	0.1% + 0.005%	0.05% + 0.005%	0.1% + 0.005%
300 V	10 mV	0.05% + 0.005%	0.1% + 0.005%	0.05% + 0.005%	0.1% + 0.005%
<p><b>Temperature Coefficient:</b> (0.001% of rdg. + 0.0015% f.s.)/°C in the ranges -10 to 18°C and 28 to 50°C</p> <p><b>Input Impedance:</b> 5 M<math>\Omega</math></p> <p><b>Common Mode Error:</b> 0.008% f.s./(Common Mode Volt)</p> <p><b>Maximum Input Voltage:</b> 300V rms</p>					

## AC Voltage Measurement

FREQUENCY RANGE	MODEL 701 AND 702 (% OF READING + NUMBER OF COUNTS)	
	1 YEAR	2 YEAR
20 to 40 Hz	2% + 10	2% + 10
40 to 500 Hz	0.5% + 5	0.5% + 5
500 Hz to 1 kHz	2% + 10	2% + 10
1 kHz to 5 kHz	10% + 20	10% + 20

Specifications apply for 10% to 100% of voltage range  
**Ranges** : 1.1000 V, 11.000 V, 110.00 V, 300.0 V rms  
**Resolution**: 11.000 counts in all ranges except 300V; 3,000 counts on 300V range.  
**Input Impedance**: 5 M $\Omega$  and <100 pF  
**Temperature Coefficient**: 10% of spec/ $^{\circ}$ C in the ranges -10 to 18 $^{\circ}$ C and 28 to 50 $^{\circ}$ C  
**Input Coupling**: ac  
**Maximum Input Voltage**: 300 V rms  
 For frequencies >1 kHz, the minimum voltage is 0.5 V

### DC Current Measurement

RANGE	RESOLUTION	MODEL 702 % OF READING +% OF FULL SCALE		MODEL 701 % OF READING +% OF FULL SCALE	
		1 YEAR	2 YEAR	1 YEAR	2 YEAR
30 mA	1 $\mu$ A	0.025% + 0.025%	0.025% + 0.03%	0.025% + 0.025%	0.025% + 0.03%
110 mA	10 $\mu$ A	0.05% + 0.05%	0.07% + 0.07%	0.05% + 0.05%	0.1% + 0.07%
<b>Temperature Coefficient:</b> (0.001% of rdg. + 0.002% f.s.)/ $^{\circ}$ C in the ranges -10 to 18 $^{\circ}$ C and 28 to 50 $^{\circ}$ C <b>Common Mode Error:</b> 0.01% f.s./(Common Mode Volt) <b>Maximum Input Voltage:</b> 30V dc					

### Resistance Measurement

RANGE	RESOLUTION	MODEL 702 % OF READING + Ohms		MODEL 701 % OF READING + Ohms	
		1 YEAR	2 YEAR	1 YEAR	2 YEAR
11 $\Omega$	0.001 $\Omega$	0.05% + 0.05	0.075% + 0.05	0.1% + 0.05	0.15% + 0.05
110 $\Omega$	0.01 $\Omega$	0.05% + 0.05	0.075% + 0.05	0.1% + 0.05	0.15% + 0.05
1.1 k $\Omega$	0.1 $\Omega$	0.05% + 0.5	0.075% + 0.5	0.1% + 0.5	0.15% + 0.5
11 k $\Omega$	1 $\Omega$	0.1% + 10	0.1% + 10	0.1% + 10	0.15% + 10
<b>Temperature Coefficient:</b> (0.01% f.s. + 2 m $\Omega$ )/ $^{\circ}$ C in the ranges -10 to 18 $^{\circ}$ C and 28 to 50 $^{\circ}$ C <b>Common Mode Error:</b> 0.005% f.s.(Common Mode Volt) <b>Maximum Input Voltage:</b> 30V dc					

## Continuity Testing

TONE	RESISTANCE
Continuous Tone	<25 $\Omega$
May or may not get tone	25 to 400 $\Omega$
No tone	>400 $\Omega$

## Frequency Measurement

RANGES	MODEL 701 AND 702 COUNTS	
	1 YEAR	2 YEAR
1 Hz to 109.99 Hz	5	5
110 Hz to 1099.9 Hz	5	5
1.100 kHz to 10.999 kHz	5	5
11 kHz to 50 kHz	5	5

**Amplitude range for frequency measurement:**

<1 kHz: 110 mV to 300V

1 kHz to 30 kHz: 0.5 to 30V

>30 kHz: 1V to 30V

**Input Impedance:** 5 M $\Omega$

*For frequency measurement less than 109.99 Hz, specification applies for signals with a slew rate greater than 5 volt/millisecond.*

**DC Voltage Output**

RANGE	RESOLUTIONS	MODEL 702 % OUTPUT +% OF FULL SCALE		MODEL 701 % OUTPUT +% OF FULL SCALE	
		1 YEAR	2 YEAR	1 YEAR	2 YEAR
110 mV	1 $\mu$ V	0.01% + 0.005%	0.015% + 0.005%	0.015% + 0.005%	0.02% + 0.005%
1.1 V	10 $\mu$ V	0.01% + 0.005%	0.015% + 0.005%	0.015% + 0.005%	0.02% + 0.005%
11 V	100 $\mu$ V	0.01% + 0.005%	0.015% + 0.005%	0.015% + 0.005%	0.02% + 0.005%

**Temperature Coefficient:** (0.001% of output + 0.001% of f.s.)/°C in the ranges -10 to 18°C and 28 to 50°C  
**Maximum Output Current:** 10 mA  
**Loading:** (0.001% f.s. + 1  $\mu$ V)/ mA  
**Common Mode Error:** 0.008% f.s./(Common Mode Volt)  
**Maximum Input Voltage:** 30V dc

**DC Current Output**

RANGE	RESOLUTION	MODELS 701 AND 702 % OUTPUT +% OF FULL SCALE	
		1 YEAR	2 YEAR
22 mA	1 $\mu$ A	0.01% + 0.04%	0.02% + 0.06%
<b>Maximum Burden Voltage:</b> 24V <b>Temperature Coefficient:</b> (0.003% of output + 0.003% of f.s.)/°C in the ranges -10 to 18°C and 28 to 50°C <b>Common Mode Error:</b> 0.008% f.s./(Common Mode Volt) <b>Maximum Input Voltage:</b> 30V dc			
<i>Specification applies for currents between 2 mA and 22 mA. For current below 2 mA, typical accuracy is 0.15% of full scale.</i>			

### Resistance Sourcing

RANGES	RESOLUTION	MODEL 702 % OUTPUT + OHMS		MODEL 701 % OUTPUT + OHMS	
		1 YEAR	2 YEAR	1 YEAR	2 YEAR
11.000Ω	1 mΩ	0.01% + 0.02	0.02% + 0.02	0.02% + 0.02	0.03% + 0.02
110.00Ω	10 mΩ	0.01% + 0.04	0.02% + 0.04	0.02% + 0.04	0.03% + 0.04
1.1000 kΩ	100 mΩ	0.02% + 0.5	0.03% + 0.5	0.05% + 0.5	0.1% + 0.5
11.000 kΩ	1Ω	0.03% + 5	0.04% + 5	0.1% + 5	0.15% + 5

**Temperature Coefficient:** (0.01% of f.s.)/°C in the ranges -10 to 18°C and 28 to 50°C

**Maximum/Minimum Current through Source Resistance:**

- 11Ω Range:** 3 mA dc max, 0.1 mA dc min
- 110Ω Range:** 3 mA dc max, 0.1 mA dc min
- 1.1 kΩ Range:** 3 mA dc max, 0.01 mA dc min
- 11 kΩ Range:** 1 mA dc max, 0.01 mA dc min

**Common Mode Error:** 0.008% f.s./(Common Mode Volt)

**Maximum Input Voltage:** 30V dc

## Frequency Sourcing

FREQUENCY RANGES	MODELS 702 AND 701 COUNTS	
	1 YEAR	2 YEAR
2 Hz to 109.99 Hz	1	1
110 Hz to 1099 Hz	1	1
1.1 kHz to 10.9 kHz	1	1
11 kHz to 50 kHz	2	2

**Waveform:** Squarewave, 50% duty cycle  
**Amplitude:** 0 to 10V pk  
**Amplitude Accuracy:**  
     **2 to 1099 Hz:** 3% of output + 0.05 V  
     **1.1 to 10.9 kHz:** 10% of output + 0.05 V  
     **11 to 50 kHz:** 30% of output + 0.05 V  
**Maximum Input Voltage:** 30V dc



**Temperature, Thermocouples**

TYPES (°C)	MEASURE DEGREES C		SOURCE DEGREES C	
	1 YEAR	2 YEAR	1 YEAR	2 YEAR
<b>E</b>				
-250 to -200	1.3	2.0	0.6	0.9
-200 to -100	0.5	0.8	0.3	0.4
-100 to 600	0.3	0.4	0.3	0.4
600 to 1000	0.4	0.6	0.2	0.3
<b>N</b>				
-200 to -100	1.0	1.5	0.6	0.9
-100 to 900	0.5	0.8	0.5	0.8
900 to 1300	0.6	0.9	0.3	0.4
<b>J</b>				
-210 to -100	0.6	0.9	0.3	0.4
-100 to 800	0.3	0.4	0.2	0.3
800 to 1200	0.5	0.8	0.2	0.3
<b>L</b>				
-200 to -100	0.6	0.9	0.3	0.4
-100 to 800	0.3	0.4	0.2	0.3
800 to 900	0.5	0.8	0.2	0.3

**Temperture, Thermocouples (cont)**

TYPES (°C)	MEASURE DEGREES C		SOURCE DEGREES C	
	1 YEAR	2 YEAR	1 YEAR	2 YEAR
<b>K</b>				
-200 to -100	0.7	1.0	0.4	0.6
-100 to 400	0.3	0.4	0.3	0.4
400 to 1200	0.5	0.8	0.3	0.4
1200 to 1372	0.7	1.0	0.3	0.4
<b>T</b>				
-250 to -200	1.7	2.5	0.9	1.4
-200 to 0	0.6	0.9	0.4	0.6
0 to 400	0.3	0.4	0.3	0.4
<b>U</b>				
-200 to 0	0.6	0.9	0.4	0.6
0 to 600	0.3	0.4	0.3	0.4
<b>B</b>				
600 to 800	1.3	2.0	1.0	1.5
800 to 1000	1.0	1.5	0.8	1.2
1000 to 1820	0.9	1.3	0.8	1.2

**Temperature, Thermocouples (cont)**

TYPES (°C)	MEASURE DEGREES C		SOURCE DEGREES C	
	1 YEAR	2 YEAR	1 YEAR	2 YEAR
R				
-20 to 0	2.3	2.8	1.2	1.8
0 to 100	1.5	2.2	1.1	1.7
100 to 1767	1.0	1.5	0.9	1.4
S				
-20 to 0	2.3	2.8	1.2	1.8
0 to 200	1.5	2.1	1.1	1.7
200 to 1400	0.9	1.4	0.9	1.4
1400 to 1767	1.1	1.7	1.0	1.5
C				
0 to 800	0.6	0.9	0.6	0.9
800 to 1200	0.8	1.2	0.7	1.0
1200 to 1800	1.1	1.6	0.9	1.4
1800 to 2316	2.0	3.0	1.3	2.0

**Sensor inaccuracies not included.**

**Accuracy with external cold junction; for internal junction add 0.2°C**

**Resolution:** 0.1°C

**Temperature Scale:** ITS-90 or IPTS-68, selectable

**Compensation:** ITS-90 per NIST Monograph 175 for B,R,S,E,J,K,N,T; IPTS-68 per IEC 584-1 for B,R,S,E,J,K,T; IPTS-68 per DIN 43710 for L,U.

**Temperature Coefficient:** 0.05°C/°C in the range -10 to 18°C and 28 to 50°C

**Common Mode Error:** 0.01°C/(Common Mode Volt)

**Maximum Input Voltage:** 30 V

**Temperature, Resistance Temperature Detectors**

Temperature, RTDs, Model 702 and 701				
TYPES (°C)	MEASURE DEGREES C		SOURCE DEGREES C	
	1 YEAR	2 YEAR	1 YEAR	2 YEAR
100 Ω Pt(385)				
-200 to 0	0.3	0.5	0.1	0.2
0 to 400	0.5	0.8	0.2	0.4
400 to 800	0.8	1.0	0.4	0.5
100 Ω Pt(3926)				
-200 to 0	0.3	0.4	0.1	0.2
0 to 630	0.5	0.8	0.2	0.4
120 Ω Ni(672)				
-80 to 260	0.3	0.4	0.1	0.2
10Ω Cu(427)				
-100 to 0	2	2	1	1
0 to 260	2	2	1	1

**Temperature, Resistance Temperature Detectors (cont)**

100Ω Pt(3916)				
-200 to -190	0.3	0.4	0.3	0.4
-190 to 0	0.3	0.4	0.1	0.2
0 to 630	0.5	0.8	0.2	0.4
200Ω, 500Ω, 1000Ω Pt(385)				
-200 to 0	0.3	0.5	0.1	0.2
0 to 400	0.5	0.8	0.2	0.4
400 to 630	0.8	1.0	0.4	0.5
<b>Sensor inaccuracies not included</b> <b>Resolution:</b> 0.1°C <b>Temperature Coefficient:</b> 0.02°C/°C in the ranges -10 to 18°C and 28 to 50°C <b>Maximum Input Voltage:</b> 30V				
For two and three-wire RTD measurements, add 0.4°C to the specifications.				

**Loop Power Supply**

SETTING	MODELS 702 AND 701	
	1 YEAR	2 YEAR
24 Volt	5%	5%
28 Volt	5%	5%
<b>Short circuit protected</b> <b>Maximum Current:</b> 22 mA <b>Maximum Input Voltage:</b> 30V dc		

**Top and Bottom Limits of Ranges with Auto Range On**

<b>RANGE, DC V MEASURE</b>	<b>TOP OF RANGE</b>	<b>BOTTOM OF RANGE</b>
110 mV	±110.000 mV	0.000 mV
1.1 V	±1.10000 V	±0.10000 V
11 V	±11.0000 V	±1.0000 V
110 V	±110.000 V	±10.000 V
300 V	±300.00 V	±100.00 V
<b>RANGE, DC V SOURCE</b>		
110 mV	+110.000 mV	-10.000 mV
1.1 V	+1.10000V	+0.10000 V
11 V	+11.000V	+1.1000 V
<b>RANGE, OHMS MEASURE AND SOURCE</b>		
11 Ω	11.000 Ω	0.000 Ω
110 Ω	110.00 Ω	10.00 Ω
1.1 kΩ	1100.0 Ω	100.0 Ω
11 kΩ	11.000 kΩ	1.000 kΩ
<b>RANGE, CURRENT MEASURE</b>		
22 mA	+22.000 mA	0.000 mA

***Top and Bottom Limits of Ranges with Auto Range On (cont)***

<b>RANGE, MEASURE V CC</b>		
110 mA	+110.00 mA	+30.00 mA
<b>RANGE, CURRENT SOURCE</b>		
22 mA	+30.000 mA	0.000 mA
<b>RANGE, FREQUENCY MEASURE</b>		
100 Hz	109.99 Hz	1.00 Hz
1 kHz	1099.9 Hz	100.00 Hz
10 kHz	10.999 kHz	1.000 kHz
50 kHz	50.00 kHz	10.00 kHz

## **General Specifications**

<b>Display:</b>	240 by 200 pixel graphic LCD, 70 x 58 mm.
<b>Power:</b>	Internal Battery Pack: NiCd, 7.2V, 1700 mAh.
<b>Memory Backup:</b>	Lithium battery, 5 years typical lifetime.
<b>Dimensions:</b>	130 x 236 x 61 mm (5.1 x 9.3 x 2.4 in.).
<b>Weight:</b>	1.4 kg (3 lb. 1 oz.).
<b>Altitude:</b>	Up to 2800 meters (9186 ft) above mean sea level.
<b>Environmental</b>	0 to 50°C (operating).
<b>Temperature:</b>	-20 to 60°C (storage).
<b>Humidity:</b>	Avoid prolonged use outside the safe operating boundaries shown in the graph below.
<b>Safety:</b>	Designed in accordance with IEC 1010-1, ANSI/ISA-S82, UL1244, and CSA C22.2 #231. See Safety Information in this manual.
<b>Warranty:</b>	See the WARRANTY, inside front cover.



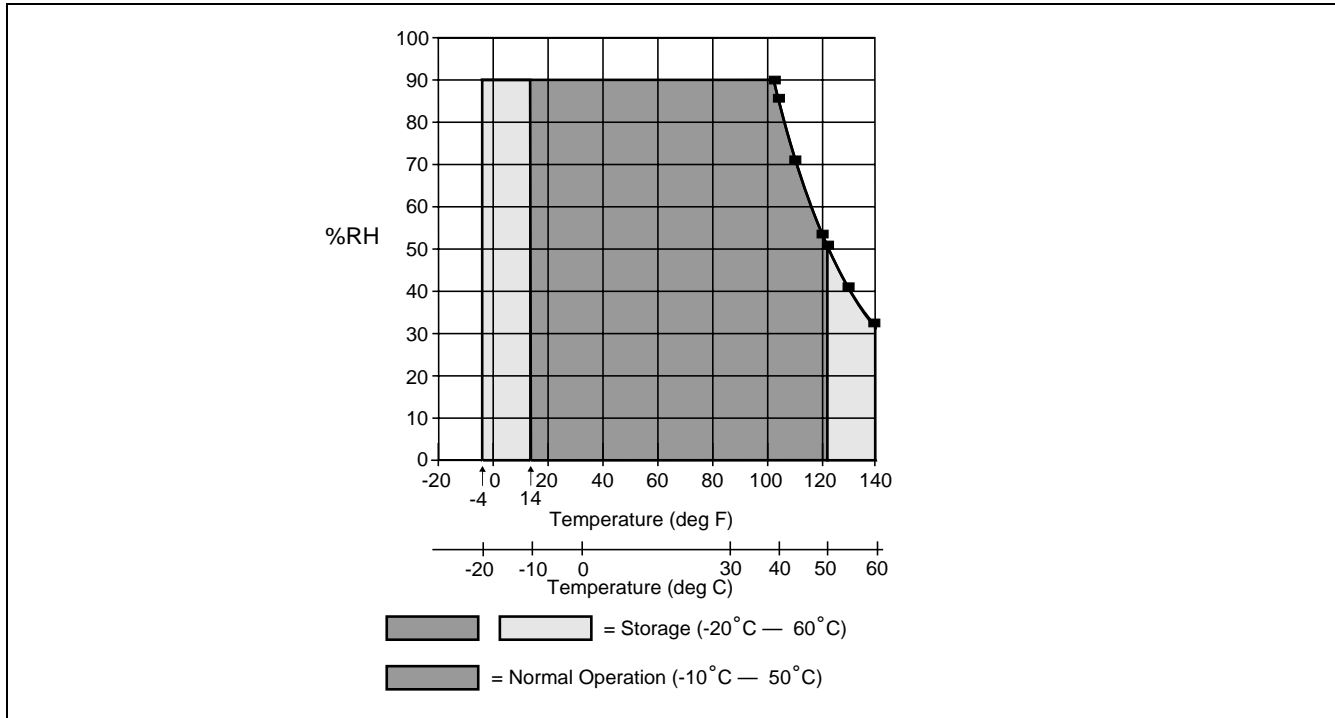

Figure 34. Operating Environment Specification



# *Index*

## **—4—**

4 to 20 ma transmitter  
simulating, 43

## **—A—**

As found test data, 62  
As left test data, 67  
Auto  
backlight timeout, 26  
battery save timeout, 23

## **—B—**

Backlight, 25  
auto timeout, 26  
Bail, 17  
Battery  
auto save timeout, 23  
charge life, 21  
eliminator, 23  
lithium backup, 83  
replacement, 83  
Battery, charging, 20  
Battery, removing, 20

## **—C—**

Calibrating a process instrument, 62  
Calibration, 84  
data, 84  
Cleaning  
the calibrator, 83  
Clear memory, 73  
Communicating with a PC (702 only), 83  
Connections  
for electrical measurement,  
28

for measuring pressure, 32  
Continuity  
  testing, 30  
  trip detect during ramping, 55  
Contrast  
  adjusting display, 24  
Current  
  measuring, 28  
  sourcing, 41

## —D—

Damping measurements, 40  
Date  
  display, activating, 24  
  format, 24  
Display, 17  
Display language  
  selecting, 24

## —F—

Frequency  
  measuring, 28  
  sourcing, 41

## —J—

Jacks, 12

## —K—

Key functions, 14  
Keys, 14

## —L—

Language  
  selecting, 24  
Log softkey (702 only), 70  
Logging data (702 only), 70  
Loop power  
  providing, 45  
  simulating, 43

## —M—

Measure  
  mode, 27  
Measure/source mode, 59  
Measurement  
  damping, 40

Measuring  
  continuity, 30  
  current, 28  
  electrical parameters, 28  
  frequency, 28  
  pressure, 30  
  resistance, 28  
  temperature with thermocouples, 33  
  voltage, 28  
Memory, 68  
  clearing, 73  
  reviewing, 69  
Min max measurement display, 72

## —N—

Name field in setup, 26

## —P—

Percent of scale  
  measurement display, 40  
  source display, 54  
Pressure

connections for measuring,  
32  
measuring, 30  
modules, gage and differential (illustration), 32  
sourcing, 47  
Pressure modules  
connecting, 31  
list of models, 7

## —R—

Ramping the output, 55  
Repair, 84  
Replacement parts, 84  
Resistance  
measuring, 28  
sourcing, 41  
Results  
saving, 68  
RTD  
simulating, 52  
types, 33  
RTD (Resistance-temperature  
Detectors), 36

## —S—

Safety information, 10  
Saving results, 68  
Scale  
measurements in percent of,  
40  
softkey for measure, 40  
temperature, 33, 38  
Scale softkey, 40  
Servicing, 84  
Setting, 24  
Setting up, 17  
Simulating, 50  
loop power, 43  
thermocouples, 50  
Simultaneous measure/source,  
59  
Source  
mode, 41  
Source mode, 41  
Sourcing  
current, 41  
electrical parameters, 41  
frequency, 41  
in percent of scale, 54  
loop powe, 45

pressure, 47  
resistance, 41  
thermocouples, 50  
voltage, 41  
Standard equipment, 4  
Step size softkey, 54  
Stepping the output, 54  
Strap, 17

## —T—

Task list (702 only), 72  
Telephone number  
parts, service, or assistance,  
2  
Temperature  
Measuring with Thermocou-  
ple, 33  
scale, 33, 38  
Thermocouple  
measuring, 33  
measuring temperature with,  
33  
sourcing, 50  
types, 33  
Time  
display, activating, 24

format, 24  
Transmitter  
  4 to 20 ma, simulating, 43  
Trip detect during ramping, 55

**—U—**

Units  
  temperature, 33, 38  
Uploading to a PC (702 only),  
  83

**—V—**

Voltage  
  measuring, 28  
  sourcing, 41  
  trip detect during ramping, 55