



**PRODUCT SERVICE MANUAL FOR**

**F312XICR-312\_, 325\_, 400\_ and 437\_ Pumps**

**For Solar Turbines**

	<b>WARNING</b>	
<b>This manual and the “General Installation, Operation, Maintenance and Troubleshooting Manual” (SRM00046) should be read in their entirety prior to installing, operating or servicing this pump.</b>		

<b>Manual No SRM00105</b>	<b>Rev. 00</b>	<b>December 2011</b>
---------------------------	----------------	----------------------



## READ ENTIRE PAGE BEFORE PROCEEDING

FOR SAFETY OF PERSONNEL AND TO PREVENT DAMAGE TO EQUIPMENT, THE FOLLOWING NOMENCLATURE HAS BEEN USED IN THIS MANUAL:

	<b>DANGER</b>	
Failure to observe precautions noted in this box can result in severe bodily injury or loss of life.		

	<b>WARNING</b>	
Failure to observe precautions noted in this box can cause injury to personnel by accidental contact with the equipment or liquids. Protection should be provided by user to prevent accidental contact.		

	<b>CAUTION</b>		<b>ATTENTION</b>
Failure to observe precautions noted in this box can cause damage or failure of equipment.			

Non compliance of safety instructions identified by the following symbol could affect safety for persons:	Safety instructions where electrical safety is involved are identified by:	Safety instructions which shall be considered for reasons of safe operation of pump and/or protection of the pump itself are marked by the sign:
		<b>ATTENTION</b>

## CONTENTS

SAFETY AND TABLE OF CONTENTS .....	2
A. GENERAL INSTRUCTIONS .....	3
B. INTRODUCTION .....	3
C. DESCRIPTION OF THE PUMP .....	3
D. PUMP MODEL IDENTIFICATION .....	4
E. ORDERING INSTRUCTIONS .....	4
F. OPERATION .....	4
G. PARTS LIST .....	5
H. ASSEMBLY AND DISASSEMBLY .....	5
I. TROUBLESHOOTING .....	6
J. FIELD AND FACTORY SERVICE AND PARTS .....	6
K. ASSEMBLY DRAWING .....	7

### IMPORTANT NOTE

If operation of pump is critical to your business, we strongly recommend keeping a spare pump or major repair kit in stock at all times. For expeditious pump refurbishment, as a minimum, keep a minor repair kit (o-rings, gaskets, shaft seal and bearings) in stock.

## A. GENERAL INSTRUCTIONS

Instructions found herein cover disassembly, assembly and parts identification of F312XICR series pumps.

**NOTE:** Individual contracts may have specific provisions that vary from this manual. Should any questions arise which may not be answered by these instructions, refer to General Instructions Manual, CA-1, provided with your order. For further detailed information and technical assistance please refer to Imo Pump, Technical/Customer Service Department, at (704) 289-6511.

This manual cannot possibly cover every situation connected with installation, operation, inspection, and maintenance of equipment supplied. Every effort was made to prepare manual text so that engineering and design data is transformed into most easily understood wording. Imo Pump must assume personnel assigned to operate and maintain supplied equipment and apply this instruction manual have sufficient technical knowledge and are experienced to apply sound safety and operational practices which may not be otherwise covered by this manual.

In applications where equipment furnished by Imo Pump is to become part of processing machinery, these instructions should be thoroughly reviewed to ensure proper fit of said equipment into overall plant operational procedures.

	<b>WARNING</b>	
If installation, operation and maintenance instructions are not correctly and strictly followed and observed, injury to personnel or serious damage to pump could result. Imo Pump cannot accept responsibility for unsatisfactory performance or damage resulting from failure to comply with instructions.		

## B. INTRODUCTION

This instruction manual covers F312XICR pumps. This series of pumps has been designed for use in Lube oil applications. Model, and design construction of each pump can be identified by designator code on pump nameplate. Definitions of model designators are identified in Figure 1 below.

## C. DESCRIPTION OF EQUIPMENT

F312XICR pumps are positive displacement, rotary screw pumps consisting of a precision bored housing that encloses a driven screw (power rotor) and two intermeshing following screws (idler rotors). These screws, when rotating, form a succession of closures or cavities. As they rotate, fluid is moved axially from inlet port to outlet port in a continuous, uniform flow with minimum fluid pulsation and pump noise.

## D. PUMP MODEL IDENTIFICATION

This instruction manual covers Imo F312XICR pumps. Model of each pump is identified on pump nameplate.

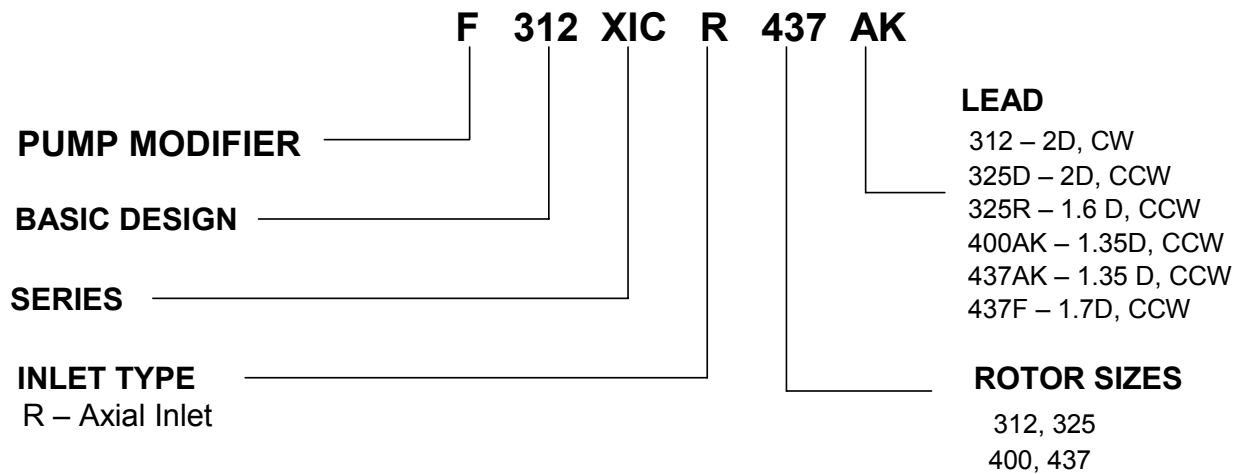

**FIGURE 1 – Model Designators**

## E. ORDERING INSTRUCTIONS

When corresponding with Imo Pump regarding F312XICR pumps, refer to pump nameplate, this instruction manual, and assembly drawing as instructed below:

1. From pump nameplate, record pump model number, serial number and manufactured date.
2. Record instruction manual number, revision and date.
3. From assembly drawing and/or parts list (table 2) in manual, provide identification numbers and names for replacement part(s).
4. Give above information to your Imo service representative.

Imo sales and service representatives are listed herein and in General Installation, Operation, Maintenance and Troubleshooting Manual, SRM00046

## F. OPERATION

### F.1 LIQUID LIMITATIONS

	<b>CAUTION</b>		<b>ATTENTION</b>	
Never operate with water. Pump is designed for liquids having general characteristics of oil.				

### F.2 OPERATING LIMITS

	<b>CAUTION</b>		<b>ATTENTION</b>	
Operating conditions, such as speed, fluid viscosity, temperature inlet pressure, discharge pressure, filtration, duty cycle, drive type, mounting, etc., are interrelated. Due to these variable conditions, specific application limits may be different from that of operational limitations. Equipment must not be operated without verifying system's operating requirements are within pump's capabilities.				

**Under no circumstances are the following operating limits (specified in Table 1) to be exceeded without specific approval from Imo Pump.**

**Table 1 – Normal Pump Operating and Structural Limits**

MAXIMUM SPEED .....	2250 RPM
VISCOSITY .....	40 SSU (4.3 CST) Min – 3000 SSU (650 CST) Max
MINIMUM – MAXIMUM LIQUID TEMPERATURE.....	0 to 250° F (-18 to 121°C)
MAXIMUM INLET PRESSURE .....	25 Psig
MAXIMUM DISCHARGE PRESSURE .....	200 psig, Cont. Duty
FILTRATION .....	(See General Instruction Manual, SRM00064)
DRIVE .....	Direct only
MOUNTING .....	Flange mounted

## G. PARTS LIST

**Table 2 – Pump Parts List**

IDP	QTY	DESCRIPTION	KIT	IDP	QTY	DESCRIPTION	KIT
1	1	Case/Housing		10	1	Key	
2	1	Power Rotor		11	1	Nameplate	
3	2	Idler		12	1	Nameplate, Rotation	
4	1	Inlet head		13	1	Nameplate, Suction	
5	1	Bearing	X	14	1	Nameplate, Discharge	
6	1	Retaining Ring	X	15	1	Nameplate Drive	
7	1	Retaining Ring	X	20	4	Pipe Plugs	
8	1	Inlet O-ring or Gasket	X	21	3	Pipe Plugs	
9	6	Cap Screws					

X = Minor Repair Kit Items.

## H. Assembly and Disassembly Procedures:

	<b>WARNING</b>	
Failure to observe precautions while installing, inspecting and maintaining pump can cause injury to personnel from accidental handling of liquids that may harm skin or clothing, or fire hazard risks from flammable liquids, or injury from high pressure fluid jets.		

	<b>DANGER</b>	
<b>BEFORE</b> working on equipment, make sure all power to equipment is disconnected and locked-out.		

### H.1 GENERAL COMMENTS

**NOTE:** Part number identifiers contained within parenthesis such as (9) refer to circled numbers shown on assembly drawing.

### H.2 TOOLS REQUIRED

Procedures described in manual require common mechanics hand tools, a torque wrench, dial indicator and suitable lifting device (such as) slings, straps, etc.

### H.3 DISASSEMBLY PROCEDURES – See Assembly Drawing

	<b>CAUTION</b>	
Fluid leakage from disassembly of pump may make floor slippery and cause personal injury.		

1. Close discharge piping to pump, disconnect piping and drain unit. Remove pump from driver. Remove coupling key (10).
2. Remove inlet head (4) by removing capscrews (9) and then remove gasket (8).
3. Remove snap ring (6) from case/housing (1).
4. Remove power rotor (2) with bearing (5) and intermeshed idlers (3) from case/housing (1).

	<b>CAUTION</b>	
Be sure intermeshed idlers (3) do not drop as they emerge from case/housing (1).		

5. Remove bearing (5) from power rotor (2) by first removing retaining ring (7) and then pressing bearing (5) off power rotor (2).

### H.4 PUMP ASSEMBLY PROCEDURE– See Assembly Drawing

**Note:** Prior to reassembly of pump, all parts should be cleaned and inspected for nicks and burrs. Replace all worn or damaged parts. Imo Pump recommends replacement of gasket (8), and ball bearing (5) when these parts are disturbed from their previously installed positions. Coat all parts with light lubricating oil to assist in assembly.

1. Install ball bearing (5) on power rotor (2) by pressing only on inner race of ball bearing (5) until it seats firmly next to step in shaft (2), then install snap ring (7) in groove on shaft (2).
2. Mesh the two idlers (3) and power rotor (2) together into a rotor assembly making sure idler rotors (3) and balance piston are properly engaged.
3. Install rotors with installed ball bearing (5) and snap ring (6) by sliding rotor assembly into case/housing (1) bores.
4. Install snap ring (6) in case/housing (1).
5. Install inlet (4) on case/housing (1) using bolts (9). Torque bolts to value on assembly drawing.
6. Install coupling hub key (10) and Install and align pump and driver as specified in "General Installation, Operation, Maintenance and Troubleshooting Manual" (SRM00046)

## **I. TROUBLESHOOTING**

For assistance with troubleshooting see "General Installation, Operation, Maintenance and Troubleshooting Manual", SRM00046.

## **J. FIELD AND FACTORY SERVICE AND PARTS**

Imo Pump maintains a staff of trained service personnel that can provide pump installation, pump start-up, maintenance/overhaul and troubleshooting supervision as well as installation and maintenance training.

Our factories provide maintenance as well as overhaul and test facilities in the event user prefers to return pumps for inspection or overhaul. Pumps that have been factory-overhauled are normally tested and warranted "as-new" for a period of one year from date of shipment. For either field service or factory overhaul assistance, contact your local Imo Sales Office or representative at Technical/Customer Service Department in Monroe, NC. USA.

Most pumps have repair kits available. Minor Repair Kits are used to repair leaking seals, bad bearings and/or for re-assembly after pump tear-down. They include (as applicable) pump shaft seals, packing, all gaskets/O-rings and bearings. Major Repair Kits are sufficient to rebuild completely worn-out pumps to "as-new" condition. They include all parts found in Minor Repair Kits plus all major internal parts subject to wear. Since kits have all necessary parts, it is preferred that they be purchased rather than selecting individual parts. When parts are individually selected from Parts List, some needed components are often overlooked. In addition, mixing worn or used parts with new parts risks rapid wear and shortened service life from new parts.

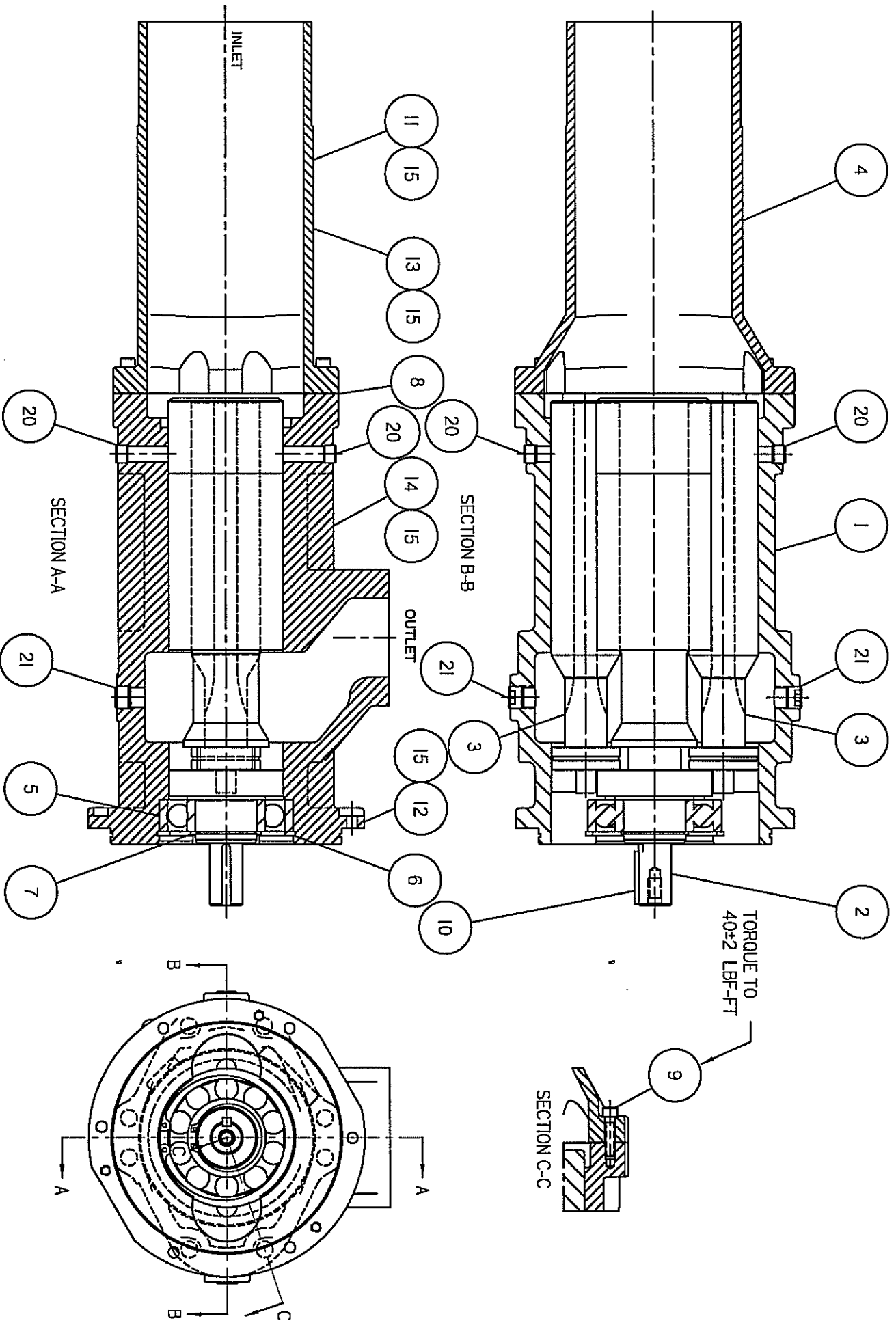

F312XICR Assembly Drawing





A Colfax Business Unit

**IMO Pump**  
1710 Airport Road 28110  
PO Box 5020  
Monroe, NC/USA 28111-5020

TEL: 1+ (704)289-6511  
Email: [imo.pump@colfaxcorp.com](mailto:imo.pump@colfaxcorp.com)  
Web: [www.imo-pump.com](http://www.imo-pump.com)

