

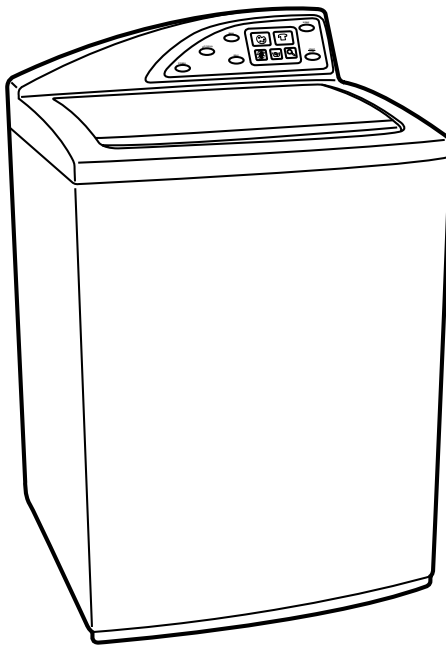

GE Consumer Products

TECHNICAL SERVICE GUIDE

Profile Washer



MODEL SERIES:

WPGT9350





IMPORTANT SAFETY NOTICE

The information in this service guide is intended for use by individuals possessing adequate backgrounds of electrical, electronic, and mechanical experience. Any attempt to repair a major appliance may result in personal injury and property damage. The manufacturer or seller cannot be responsible for the interpretation of this information, nor can it assume any liability in connection with its use.

WARNING

To avoid personal injury, disconnect power before servicing this product. If electrical power is required for diagnosis or test purposes, disconnect the power immediately after performing the necessary checks.

RECONNECT ALL GROUNDING DEVICES

If grounding wires, screws, straps, clips, nuts, or washers used to complete a path to ground are removed for service, they must be returned to their original position and properly fastened.

GE Consumer Products
Technical Service Guide
Copyright © 2003

All rights reserved. This service guide may not be reproduced in whole or in part in any form without written permission from the General Electric Company.

Table of Contents

Backsplash	23
Basic Wash Cycle	17
Bearing Housing Assembly	37
Brake Resistor	25
Clutch Shifter Assembly	35
Component Locator Views	20
Consumer Help Screens	15
Control Features	7
Control Quick Reference Chart	42
Drain Pump	30
Factory Test Mode	40
Field Service Mode	38
Hall Sensor	34
Inverter	24
Inverter and Main Board Pin Connectors	22
Main Control Board and Touch Screen LCD	23
Membrane Keypanel	24
Model Number	4
Motor Assembly	33
My Cycles	14
Nomenclature	4
Overview	6
Operation Overview	17
Outer Tub and Suspension Assembly	32
Parts □	49
Protective Cover	25
Pressure Sensor (Water Level Switch)	26
Quick Start	8
Sales Demo Mode	16
Schematic	48
Serial Number	4
Stain Inspector	10
Switching the Washer and Dryer Backsplashes	54
Summary Screen	12
Temperature Conversion Table	58
Thermistor/ATC Control (Auto Temp)	32
Top Cover	28
Troubleshooting	43
Warranty	5
Water Valve Assembly	27
Wash Basket	29
Washer Components	23
Wash Cycle Chart Example	19
Wash Cycles	9
Water Valve Assembly	27

Nomenclature

Model Number

W P G T 9 3 5 0 B 0 W W

GE Washer

Feature Pack

Common Brand Features

Exceptions:

H = Energy Star

P = Profile™

N = Special

Capacity/Configuration

L = Large S = Super Capacity Plus

X = Extra-Large K = Compact

G = Giant

Control Platform

B = Buttons (Touch Pad)

T = Touch Screen

Number of Speed

Combinations

Back Splash Color

Body Color

Engr. Revision

Model Year Designator

Voltage

0 = US Voltage

Number of Cycles

00 = Infinite Electronic

Serial Number



Note: Model number and serial number are located on rear of back splash.

- The technical sheet is located inside the control panel.

The first two characters of the serial number identify the month and year of manufacture.

Example: RF123456S = August, 2003

A - JAN	2005 - H
D - FEB	2004 - G
F - MAR	2003 - F
G - APR	2002 - D
H - MAY	2001 - A
L - JUN	2000 - Z
M - JUL	1999 - V
R - AUG	1998 - T
S - SEP	1997 - S
T - OCT	1996 - R
V - NOV	1995 - M
Z - DEC	1994 - L

The letter designating the year repeats every 12 years.

Example:

T - 1974

T - 1986

T - 1998

Warranty

All warranty service provided by our Factory Service Centers or an authorized Customer Care® technician. To schedule service, on-line, 24 hours a day, visit us at www.GEAppliances.com or call 800.GE.CARES (800.432.2737).

For The Period Of:	We Will Replace:
One Year <i>From the date of the original purchase</i>	Any part of the washer which fails due to a defect in materials or workmanship. During this full one-year warranty , GE will also provide, free of charge , all labor and related service costs to replace the defective part.
Second Year <i>From the date of the original purchase</i>	Any part of the washer which fails due to a defect in materials or workmanship. During this additional one-year limited warranty , you will be responsible for any labor or related service costs.
Third through Fifth Year <i>From the date of the original purchase</i>	The suspension rod and spring assembly, and main electronic control board if any of these parts should fail due to a defect in materials or workmanship. GE will also replace the washer lid or cover if they should rust under operating conditions. During this additional three-year limited warranty , you will be responsible for any labor or related service costs.
Third through Tenth Year <i>From the date of the original purchase</i>	The direct drive motor and outer washer tub if any of these parts should fail due to a defect in materials or workmanship. During this additional eight-year limited warranty , you will be responsible for any labor or related service costs.
Lifetime of Product <i>From the date of the original purchase</i>	The washer basket if it should fail due to a defect in materials or workmanship. During this product lifetime limited warranty , you will be responsible for any labor or related service costs.

What Is Not Covered:

- Service trips to your home to teach you how to use the product.
- Improper installation, delivery or maintenance.
- Failure of the product if it is abused, misused, or used for other than the intended purpose or used commercially.
- Replacement of house fuses or resetting of circuit breakers.
- Damage to the product caused by accident, fire, floods or acts of God.
- Incidental or consequential damage caused by possible defects with this appliance.
- Damage caused after delivery.

This warranty is extended to the original purchaser and any succeeding owner for products purchased for home use within the USA. In Alaska, the warranty excludes the cost of shipping or service calls to your home. Proof of the original purchase date is needed to obtain service under the warranty.

Some states do not allow the exclusion or limitation of incidental or consequential damages. This warranty gives you specific legal rights, and you may also have other rights which vary from state to state. To know what your legal rights are, consult your local or state consumer affairs office or your state's Attorney General.

Warrantor: General Electric Company. Louisville, KY 40225

Note: The LCD screen is part of the main electronic board and under the 5 year part warranty. The inverter board is covered by a 2 year part warranty.

Overview

General

The GE Profile Harmony Washer is part of the GE Profile Harmony Clothes Care system utilizing the latest developments in washing technology.

The Harmony Washer does not use the typical agitator found on conventional washers. Instead, the direct drive motor, capable of spinning at 1010 rpm, and the 304 stainless steel wash basket create a centrifugal force that pulls wash water through fabrics for a thorough cleaning action. (See **Operation Overview**.)

Harmony Washers also utilize an automatic load sensing system to determine load size and water levels. The washer automatically fills the wash basket with the appropriate amount of water needed for optimal wash performance.

Other features include:

Communication Link to the Dryer - The washer uses a serial cable to automatically inform the dryer about the nature of the wash load, essentially presetting the dryer controls so the user doesn't have to.

Auto-Balance Suspension - The washer is programmed to correct out of balance situations. (See **Operation Overview**.)

Flow-Thru™ Dispensers - Each of the four dispensers is timed to release at the right time during the wash cycle. Each reservoir is flushed with water to pre-dilute the product before adding it to the washer. This flushing action removes all product to help keep the compartment clean and free flowing.

Note: The bleach dispenser fills during the main wash to dispense the bleach and refills during the rinse cycle to flush any remaining bleach from the reservoir.

Direct Drive Motor - The washer does not use a transmission or mechanical brake. Direct drive technology results in fewer moving parts for smooth, quiet operation. (See **Motor Assembly**.)

Infusor™ Wash - The washer has specific cycles that aids in mixing the detergent/water solution, and dispersing the load evenly in the wash water. (See **Operation Overview**.)

LCD Touch screen Display - All washer control functions, cycles, troubleshooting, and field service diagnostics are accessed through a touch screen display. The washer can also be powered up by touching anywhere on the touch screen or any key on the keypad.

Centrifugal Wash - The washer uses a centrifugal washing action to clean clothes instead of an agitator. The basket spins creating a strong flow of water under the centrifugal force. As water passes through the fabric, its natural cleansing action washes away dirt without damaging or tangling the fabric.

Plastic Top & Backsplash - The washer top and backsplash have UV stabilizers to prevent yellowing when exposed to sunlight.

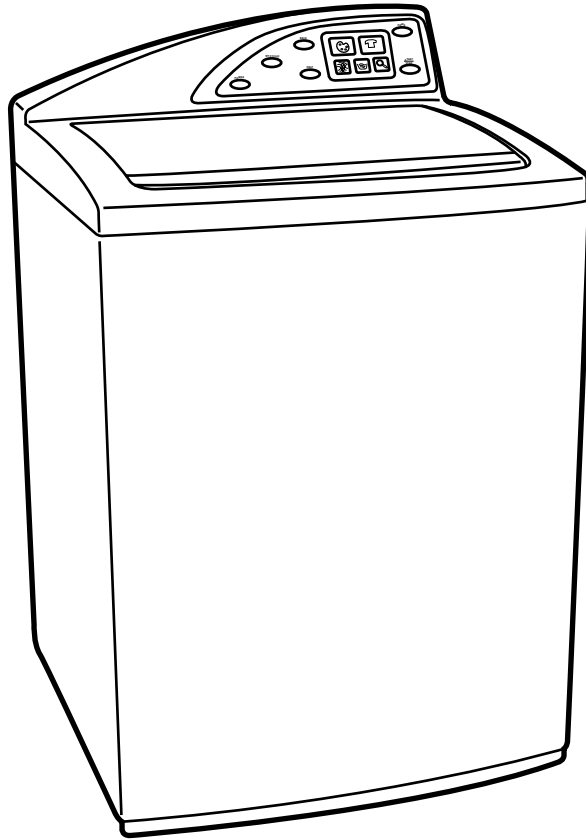

Control Features

Throughout this manual, features and appearances may vary from your model.

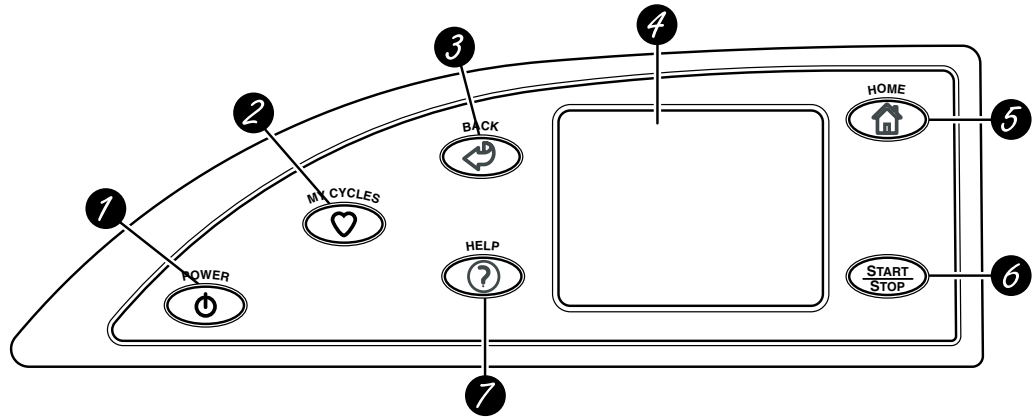

Features of the washer control panel

- 1 POWER.** Press to “wake up” the display. If the display is active, press to put the washer into standby mode. You may also press the Touch Screen or any button to “wake up” the display.
NOTE: Pressing POWER does not disconnect the appliance from the power supply.
- 2 MY CYCLES.** Press to use, create, rename, modify or delete custom wash cycles.
- 3 BACK.** Press to return to the previous screen.
- 4 TOUCH SCREEN.** Press the graphics on the interactive display to use the washer features.
NOTE: If the washer is inactive for 5 minutes, the Touch Screen will go into standby mode, and the display will be dark. Press the Touch Screen or any button to “wake up” the display.
- 5 HOME.** Press to return to the “TOUCH TO SELECT WASH CYCLE” screen (Home Screen).
- 6 START/STOP.** Press to start a wash cycle. If the washer is running, pressing once will pause the washer. Press again to restart the wash cycle.
NOTE: If the washer is paused and the cycle is not restarted within five minutes, the washer will enter standby mode and the current wash cycle will be canceled.
- 7 HELP.** Press to set machine preferences, to find help using the Touch Screen or to find troubleshooting tips for common washer problems.

Do not use sharp objects to press the Touch Screen.

NOTE: If the washer is inactive for 5 minutes, the Touch Screen will go into standby mode, and the display will be dark. Press the Touch Screen or any button to “wake up” the display.

Quick Start

Getting Started

If the Touch Screen is dark, press **POWER** or the Touch Screen to access the wash cycles menu.

- 1 Loosely load clothes no higher than the top row of holes in the washer tub. Overloading may reduce washer efficiency and possibly increase wrinkling.
- 2 Add a low-sudsing, high-efficiency detergent. Add diluted fabric softener, bleach or wash boost additives as desired.
- 3 Select one of the five wash methods from the Home Screen:
 - Press **BY COLOR** to wash according to fabric color.
 - Press **BY GARMENT** to wash according to clothing type.
 - Press **BY FABRIC** to wash according to fabric type.
 - Press **SPECIAL CYCLES** to wash non-garment items, or to select a **rinse and spin** or **spin-only** cycle.
 - Press **STAIN INSPECTOR** to wash items with specific types of stains.

After selecting a wash method, use the Touch Screen to select a specific wash cycle to match your load.

- 4 Change any of the automatic settings, if desired, by pressing the Touch Screen and following the on-screen instructions.

By changing the settings you can:

 - Remove heavier soil.
 - Change the water temperature.
 - Change the wash action to Vigorous, Normal, Delicate or Hand Wash.
 - Set a Delay Start, Extended Spin, Presoak or Extra Rinse, or change the End-of-Cycle Signal volume.
 - Adjust time settings.
- 5 Close the lid and press **START**.

The washer will not fill unless the lid is closed.

After you press **START**, a Cycle Status screen will appear to indicate what stage of the cycle the washer is in and the time remaining in the cycle.

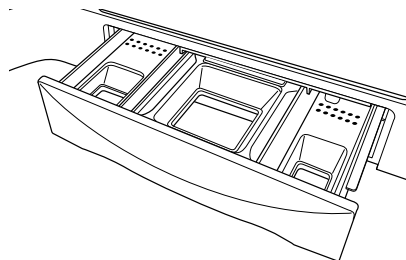

Home Screen

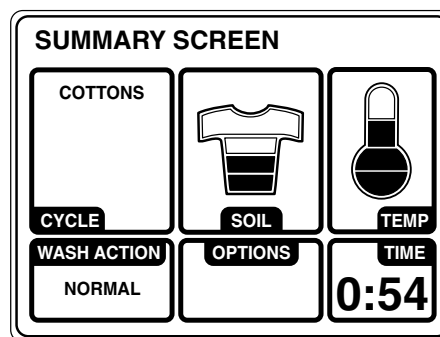

Wash Cycles

If the Touch Screen is dark, press POWER or the Touch Screen to access the wash cycles menu.

The default cycle settings are based on standard load types. Always follow the fabric manufacturer's care label when laundering.

Washing by Color

Select By Color to wash loads sorted by color.

COLOR CYCLES include:

- Bright/Dark Colors
- Light Colors
- Mixed Colors
- New Colors
- Whites



Washing by Garment Type

Select By Garment to wash loads sorted by garment type.

GARMENT CYCLES include:

- Athletic Wear
- Blouses
- Delicates
- Dress Shirts
- Easy Care
- Everyday Wear/Casual
- Jackets/Coats
- Jeans
- Khakis
- Knits
- Lingerie
- Mixed Garments
- Play Clothes
- Sweaters
- Swimwear
- Underwear
- Silks (Washable)



Washing by Fabric Type

Select By Fabric to wash loads sorted by fabric type.

FABRIC CYCLES include:

- Blends
- Cottons
- Delicates
- Knits
- Polyester
- Silks (Washable)



Washing Using the Special Cycles

Select SPECIAL CYCLES to wash loads of nongarment items or to select a rinse and spin or spin-only cycle.

SPECIAL CYCLES include:

- Blankets (Cotton)
- Blankets (Other)
- Comforter
- Super Clean
- Pet Bedding (Washable)
- Handwash Woolite® HE
- Rinse and Spin
- Sheets
- Sneakers
- Spin Only
- Throw Rugs (Washable)
- Towels
- Quick Wash



Washing Using the Stain Inspector

The **Stain Inspector** provides pretreatment tips and optimum washing for specific types of stains.

You select the specific stain, fabric type and color, and the washer creates the wash cycle for treating the stain.

Example: Washing a chocolate-stained, white cotton shirt

- 1 Press **STAIN INSPECTOR**.



- 2 Read and follow the instructions on the Touch Screen before treating the fabric.



- 3 Select **FOOD/DAIRY/COOKING** from the list of stain categories and select **CHOCOLATE** from the list of stains.

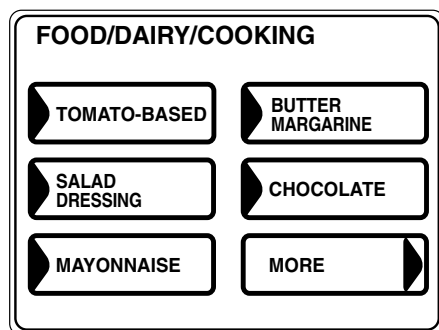

You can find additional stain categories and stains by pressing **MORE** in the lower right corner of the Touch Screen.

- 4 Press the **HELP** button to find pretreatment information for the specific type of stain.

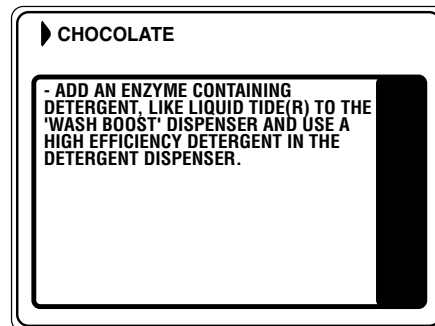

- 5 Select **COTTONS** from the list of fabric types, and select **WHITES** from the list of colors.
- 6 Fill the detergent tray with a low-sudsing, high-efficiency liquid detergent such as Tide® HE. Fill the Wash Boost tray with the proper pre-treatment additive.

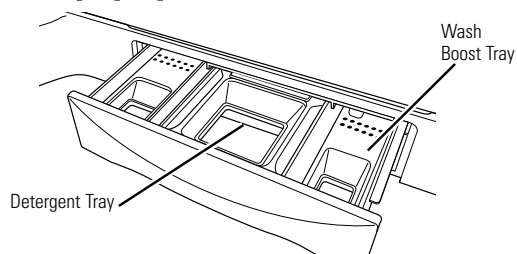

- 7 Place the stained garment(s) in the washer first; then add the rest of the load. For best stain removal, only wash items with stains matching your selection.

- 8 Press **START**.

The washer will run a Wash Boost presoak cycle prior to the main wash cycle.

NOTE: For some stain cycles, the water temperature for the presoak cycle may not be the same as the water temperature for the main wash cycle.

IMPORTANT: Check to make sure the stain is completely removed before placing the garment in the dryer.

Stain Selections

Below is a listing of the stain selections available on the washer Touch Screen. For additional information on handling these types of stains, visit the Tide® Stain Detective at www.tide.com/staindetective.

Stain Selections

Beverages

- Alcoholic beverages
- Coffee
- Fruit juice
- Kool-Aid®
- Milk
- Soda
- Tea
- Water
- Wine

School/Office/Home

- Adhesive tape
- Crayon
- Glue (synthetic)
- Glue (white/common)
- Ink
- Mildew
- Paint (water-based)
- Paint (oil-based)
- Pencil mark
- Rubber cement
- Wite-out®

Food/Dairy/Cooking

- Animal fat
- Baby formula
- Butter/margarine
- Chocolate
- Cooking oil
- Cream/cheese sauce
- Egg
- Gravy
- Grease
- Mayonnaise
- Milk
- Mustard
- Pudding
- Salad dressing
- Tomato-based
- Vegetable oil

Heavy Oils

- Motor oil
- Ointment/salve

Outdoor

- Dingy white socks
- Grass
- Mud/dirt
- Clay
- Rust/iron

Personal

- Baby stains
- Blood
- Feces
- Perspiration
- Urine
- Vomit

Cosmetics

- Chap Stick®
- Deodorant/antiperspirant
- Lipstick
- Lotions
- Makeup (oil-based)
- Makeup (water-based)

Specialty Stains

- Adhesive tape
- Asphalt/tar
- Glue (synthetic)
- Ink
- Pine sap
- Rubber cement
- Silly Putty®

Waxes

- Candle wax
- Chap Stick®
- Crayon

Summary Screen

About the Summary Screen

After selecting a wash cycle, the Summary Screen displays the automatic settings for the cycle you have chosen. You can adjust these by touching the screen location for any of the settings shown.

If you change any of the automatic settings, you can save the new settings as a custom “My Cycle” by pressing the **MY CYCLES** button and choosing **SAVE CURRENT SETTINGS**.

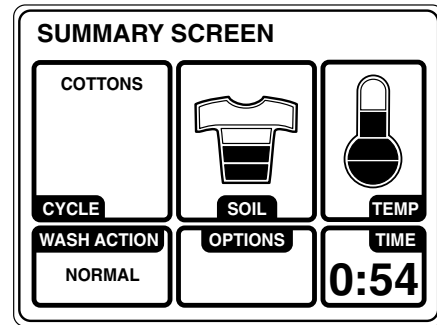

Changing the Soil Level

Changing the soil level increases or decreases the wash time to remove different amounts of soil.

To change the soil level, touch **SOIL** on the Touch Screen; then use the arrows to select more or less soil. Press **OK** when you have reached the desired setting.

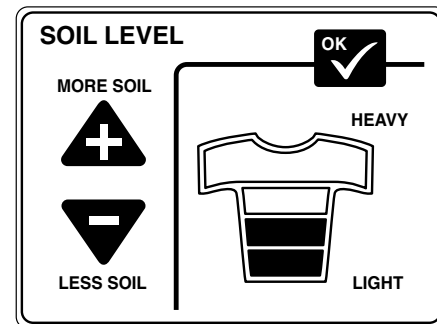

Changing the Wash Temperature

Changing the temperature changes the wash and presoak temperatures only. The final rinse will always be a cold rinse.

Follow the fabric manufacturer’s care label when selecting the wash temperature.

To change the wash temperature, touch the **TEMP** pad on the Touch Screen; then use the arrows to select a higher or lower temperature. Press **OK** when you have reached the desired setting.

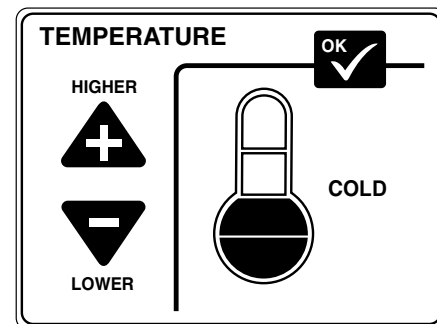

Changing the Wash Action

Changing the wash action changes the wash and spin speeds of the cycle.

Always follow the fabric manufacturer’s care label when changing the wash action.

To change the wash action, touch **WASH ACTION** on the Touch Screen; then select the desired setting.

Typically, slower spin speeds result in less water removed from clothes.

Wash Action	Wash Speed	Spin Speed
Normal	Medium	Fast
Vigorous	Fast	Fast
Delicate	Slow	Slow
Hand Wash*	Extra Slow	Extra Slow



*Use a low-sudsing, high-efficiency, gentle liquid detergent such as Woolite® HE.

Summary Screen

About the Wash Options

The Wash Options allow you to set options for the current wash cycle only. After you have made all desired changes, press **OK**.

Delay Start – Use to delay the start of your washer. Press **DELAY START** to change the delay time.

Presoak – Soaks the clothes before beginning the wash cycle. Press **PRESOAK** to change the soaking time.

Additives – Appears ONLY AFTER a presoak has been selected. Uses the contents of the Wash Boost dispenser tray for a presoak. When selected, the washer will drain after the presoak and fill again for the wash cycle. Press **ADDITIVES** to specify if you will NOT be using a Wash Boost additive or if you do not want the washer to drain after presoak.

Extra Rinse – Adds an additional cold rinse to the end of the wash cycle.

Signal – Alerts you that the cycle is complete. The clothes should be removed when the beeper goes off so wrinkles won't set in. Touch **SIGNAL** to select the volume or to turn the beeper off. The new volume will be saved as the default setting.

Extended Spin – Increases the length of the spin time to extract more water from your clothes.

NOTE: The water level will vary depending on the load size and type. The washer uses adaptive filling and load sensing to provide the appropriate water level for effective and efficient wash performance and energy usage.

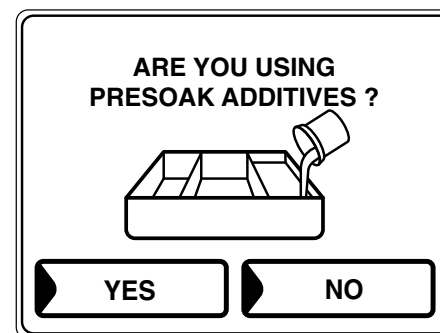
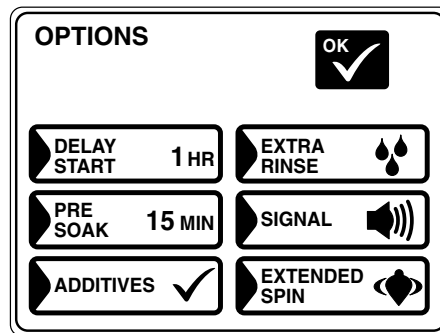

Adjusting the Time Settings

You can adjust the length of the wash cycle by changing the cycle time, adding a Delay Start or adding an Extending Spin.

Cycle Time – Press **CYCLE TIME**; then use the arrows to select more or less time.

Delay Time – Use to add a Delay Start to the beginning of the wash cycle. Press **DELAY START**; then set the DELAY START time in the OPTIONS menu.

Extended Spin – Increases the length of the spin time to extract more water from your clothes. Press **EXTENDED SPIN**; then select **EXTENDED SPIN** from the OPTIONS menu.

NOTE: After the wash cycle begins, you will not be able to change the Cycle Time or Delay Time. The washer will beep twice if you try to change the times after the cycle begins.

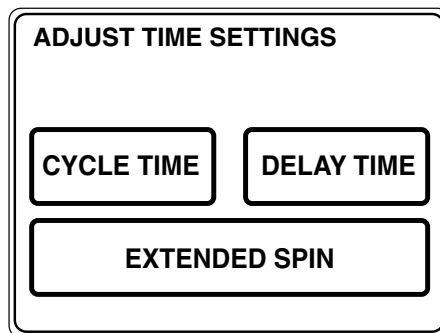

My Cycles

About the “My Cycles” Feature

The “My Cycles” feature allows you to create, store and reuse up to 6 custom cycles. Create your own cycles from scratch, or adjust the settings of a predefined wash cycle, then save for one-touch recall.

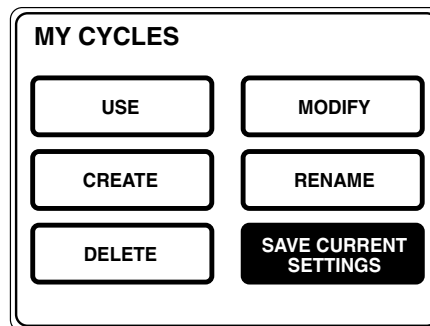

Creating and Using a “My Cycle”

You can create “My Cycles” two ways, by either modifying a predefined wash cycle or creating a cycle from your own combination of settings and options.

To build your own “My Cycle” from the Home Screen:

- 1 Press the **MY CYCLES** button.
- 2 Select **CREATE** from the Touch Screen menu.
- 3 Choose whether you want to modify a predefined cycle or create a new cycle.
- 4 If you are modifying a predefined cycle, select the wash cycle you wish to modify.
- 5 Change any of the automatic settings and select any options.
- 6 Press **SAVE** on the Touch Screen.
- 7 Using the keypad on the Touch Screen, type the name of your “My Cycle” and press **OK**.

To begin using your new “My Cycle” right away, select it from the Touch Screen menu and press **START**.

To save a current cycle as a “My Cycle” from the Summary Screen:

- 1 After setting a wash cycle, or after a wash cycle has just completed, press the **MY CYCLES** button.
- 2 Select **SAVE CURRENT SETTINGS** from the Touch Screen menu.
- 3 Using the keypad on the Touch Screen, type the name of your “My Cycle” and press **OK**.

To begin using your new “My Cycle” right away, select it from the Touch Screen menu and press **START**.

To use a “My Cycle” from the Home Screen:

- 1 Press the **MY CYCLES** button.
- 2 Select **USE** from the Touch Screen menu.
- 3 Select the cycle name from the Touch Screen menu.
- 4 Change any of the automatic settings and select any options.
- 5 Press **START**.

Modifying, Renaming or Deleting a “My Cycle”

To modify the settings of a “My Cycle” from the Home Screen:

- 1 Press the **MY CYCLES** button.
- 2 Select **MODIFY** from the Touch Screen menu.
- 3 Select the cycle name from the Touch Screen menu.
- 4 Change any of the automatic settings and select any options.
- 5 Press **SAVE** on the Touch Screen.

To delete a “My Cycle” from the Home Screen:

- 1 Press the **MY CYCLES** button.
- 2 Select **DELETE** from the Touch Screen menu.
- 3 Select the cycle name from the Touch Screen menu.
- 4 Choose **YES** to delete the cycle or **CANCEL** to return to the list of “My Cycles.”

My Cycles

To rename a “My Cycle” from the Home Screen:

- 1 Press the **MY CYCLES** button.
- 2 Select **RENAME** from the Touch Screen menu.
- 3 Select the cycle name from the Touch Screen menu.
- 4 Using the keypad on the Touch Screen, type the name of your “My Cycle” and press **OK**.

Consumer Help Screens

About the Help Feature

Pressing the **HELP** button from the Home Screen allows you to locate troubleshooting tips for common washer problems, to find help with using the Home Screen or to set machine preferences.

Pressing the **HELP** button while on any other screen allows you to find additional information on features found on that screen. Press **HELP**; then touch any pad on the Touch Screen for an explanation of that feature. To exit the feature, press **HELP** once to return to the previous screen or twice to exit Help.

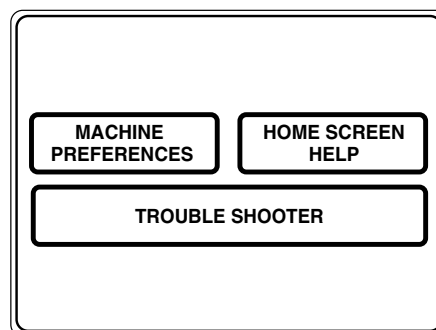

Using the Troubleshooter

To locate Troubleshooting Tips for common washer problems:

- 1 Press the **HELP** button.
- 2 On the Touch Screen, select **TROUBLE SHOOTER**.
- 3 On the Touch Screen, select the problem description from the list. You can use the arrows at the right of the screen to scroll up and down through the list of additional problems.
- 4 On the Touch Screen, select a possible cause for the problem and follow the on-screen instructions to find a solution.

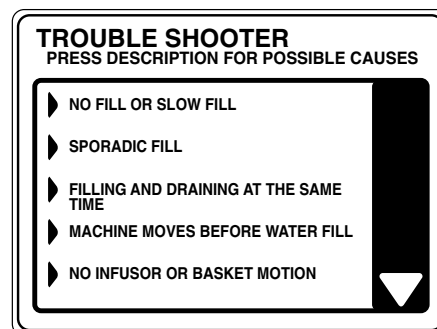

Finding Help Using the Home Screen

Pressing the **HELP** button, then selecting **HOME SCREEN HELP** allows you to find additional information on features found on the Home Screen. Touch any pad on the Touch Screen for an explanation of that feature. To exit the feature, press the **BACK** button.

Consumer Help Screens

Setting the Machine Preferences

The machine settings on the Help feature allow you to control the volume of the button beep and end-of-cycle signal, and turn the washer/dryer communication feature on or off.

Button Beep

The button beep controls the volume of the beep that is made when you press any of the buttons or the Touch Screen.

To change the volume of the button beep:

- 1 From the Home Screen, press the **HELP** button.
- 2 Select **MACHINE PREFERENCES** from the Touch Screen.
- 3 Select **BUTTON BEEP** from the Touch Screen.
- 4 Use the arrows to make the volume louder or softer, or to turn the beep off.
- 5 Select **OK** from the Touch Screen.

The new volume is now saved as the default setting.

Washer/Dryer Communication

Washer/Dryer communication allows your washer to send cycle information to your dryer to create a dry cycle that matches your wash load.

After the wash cycle is complete, communication begins once either the washer or dryer Touch Screen is activated.

Once the information is sent, your dryer will create the optimal dry cycle for your load.

To turn the Washer/Dryer Communication feature on or off:

- 1 From the Home Screen, press the **HELP** button.
- 2 Select **MACHINE PREFERENCES** from the Touch Screen.
- 3 Select **WASHER/DRYER COMMUNICATION** from the Touch Screen.
- 4 Touch the pad at the bottom of the Touch Screen to select **ON** or **OFF**.
- 5 Select **OK** from the Touch Screen.

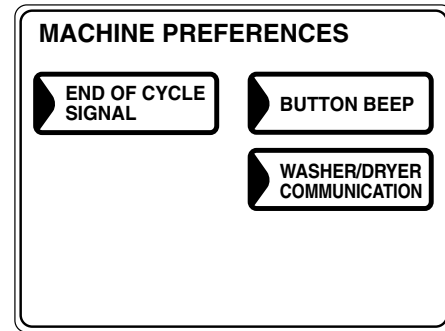

End-of-Cycle Signal

The End-of-Cycle signal alerts you when the cycle is complete.

To change the volume of the end-of-cycle signal:

- 1 From the Home Screen, press the **HELP** button.
- 2 Select **MACHINE PREFERENCES** from the Touch Screen.
- 3 Select **END OF CYCLE SIGNAL** from the Touch Screen.
- 4 Use the arrows to make the volume louder or softer, or to turn the signal off.
- 5 Select **OK** from the Touch Screen.

The new volume is now saved as the default setting.

Sales Demo Mode

Pressing HOME and MY CYCLES simultaneously for three seconds will enter into the sales demonstration mode. This mode allows the user to view a wash cycle. To exit the Demo Mode press HOME and MY CYCLES simultaneously for three seconds or disconnect the power to the machine.

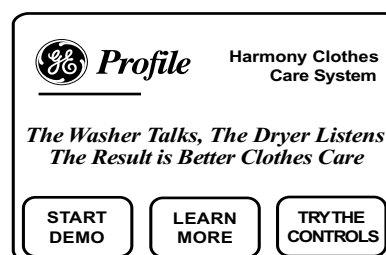

Operation Overview

Basic Wash Cycle

Note: See *Component Locator Views* for identification and location of washer components.

After a load is placed in the basket, the user selects the appropriate wash cycle on the LCD touch screen and presses start.

Cycle time and wash patterns will vary depending on user time adjustments, soil level adjustments, fabric type, and wash-load weight.

Dry Load Sensing

Before an initial fill, the infusor rotates the dry clothes load. This rotation is controlled by the inverter which measures the amount of time it takes for the motor to coast to a stop. The larger the clothes load, the less momentum the motor is capable of generating, so the faster it will stop. The infusor will rotate back and forth up to four times. This information is used to determine the initial water fill level.

Water Fill

The washer automatically fills to the proper level based on the load sensing measurements. Depending on the cycle chosen and the quantity of clothes, there are 27 possible water levels. This information is stored in memory for the final rinse at the end of the wash cycle. Water levels are matched to load size using approximately one-third less water than typical top load washers.

Note: The washer can use as little as 17.5 gallons of water for small loads and has an average water use of 27 gallons per load.

Wet Load Sensing

After the first fill, the infusor and basket lock together and rotate to measure the clothes load. During this time, the motor momentum is measured again. The washer compares this information to the previous dry load sensing measurements and determines if additional water is required.

Note: Dry load and wet load sensing are used on all cycles except the following:

SNEAKERS
COMFORTERS
BLANKETS (OTHERS)
BLANKETS (COTTONS)
THROW RUGS (WASHABLE)

The SNEAKERS cycle defaults to the minimum water level. BLANKETS, THROW RUGS and COMFORTERS cycle default to the maximum water level.

Wash Water Temperature

During the fill, the washer monitors and regulates wash water temperatures within 5°F (-15°C) of the target temperature. This accuracy is achieved using a thermistor, located in the outer tub, which monitors the tub water temperature during the fill cycle.

Based on information received from the thermistor, the inverter controls the hot and cold inlet valves to achieve the desired wash temperature. (See *Thermistor/ATC Control Auto Temp.*)

Target Water Temperatures:

Hot - 120°F (49°C)

Warm - 105°F (41°C)

Cold - 80°F (27°C)

Very Cold - 60°F (16°C)

During the fill, the basket slowly rotates in a clockwise direction. This action mixes the detergent and water to assure proper distribution and assure the thermistor is reading an accurate basket water temperature.

Basket Wash

The infusor and wash basket lock together and rotate clockwise and then counterclockwise. This action mixes the detergent and water while distributing the clothes evenly in the wash water. The basket wash speed is based on fabric type and load size. Delicate fabrics are gently rotated while heavier fabrics are rotated more vigorously.

Centrifusion Wash

The locked infusor and wash basket begin a clockwise spin (figure 1). The speed of the spin is customized to the load type and fabric type. As the basket spins faster, it creates a strong flow of water under the centrifugal force (figure 2).

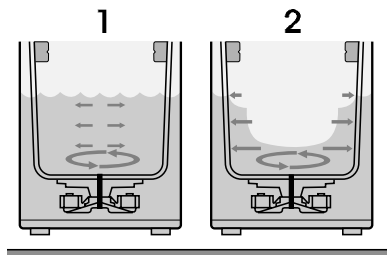

As water passes through the fabric, its natural cleansing action washes away dirt without damaging or tangling the fabric.

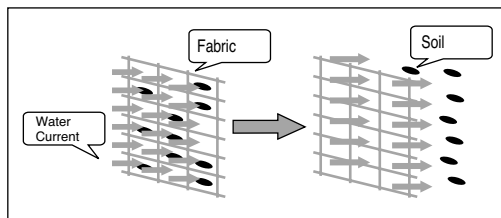

After several seconds of clockwise spinning, the basket slows down and stops. The wash water pools back into the wash basket. The wash basket starts spinning in the counterclockwise direction creating the same cleaning action. The washer will change direction (up to four times) before going to the next cycle.



Infusor Wash

Following the centrifusion wash cycle, the basket and infusor unlock. The infusor rotates to evenly distribute the wash load while continuing to clean. The redistribution of fabrics helps ensure that the lint and dirt do not become trapped.

Spin

The infusor and wash basket lock together. The basket spins very slowly at first. This allows dirty wash water and lint to drain through the holes in the bottom of the basket before a higher spin begins. When the washer senses that the excess water has drained, the wash basket accelerates to a higher speed.

Spin speeds are adaptive to fabric type that is selected by the user on the LCD touch screen. They can be as slow as 350 rpm for hand-wash items and up to 1010 rpm for heavier items. The spin is designed to extract as much water and detergent as possible without harming fabrics.

Note: During the spin cycle, excessive suds can cause excessive torque on the motor. If the washer detects this condition, it will run through the rinse, drain, and spin cycle (up to three times) in an attempt to eliminate the suds

Note: The washer is programmed to correct out of balance situations during spins. If the washer senses an out of balance load, the spin is stopped. The washer then refills to allow the infusor wash cycle to redistribute the load before starting the spin again. The washer attempts to rebalance the load three times before optimizing the spin to a lower speed where balance is sustainable.

Spray Rinse

The infusor and wash basket turn at a slow speed while fresh, clean water is added to the wash load. The spin cycle then drains this rinse water and prepares the wash load for a final rinse.

Final Rinse

The washer retrieves the information it gathered for adaptive fill cycle and uses that information to refill the washer for the final rinse. Cold water enters the basket through the fabric softener dispenser to dilute the softener into the basket and rinse the dispenser clean. The wash basket fills to the optimal level and goes into a basket wash cycle where the clothes and fabric softener are mixed thoroughly. A final spin finishes the cycle.

Note: All rinse cycles use cold water and the (ATC) automatic temperature control is not used. The cold rinse is the same temperature as the incoming cold water supply.

Wash Cycle Chart Example

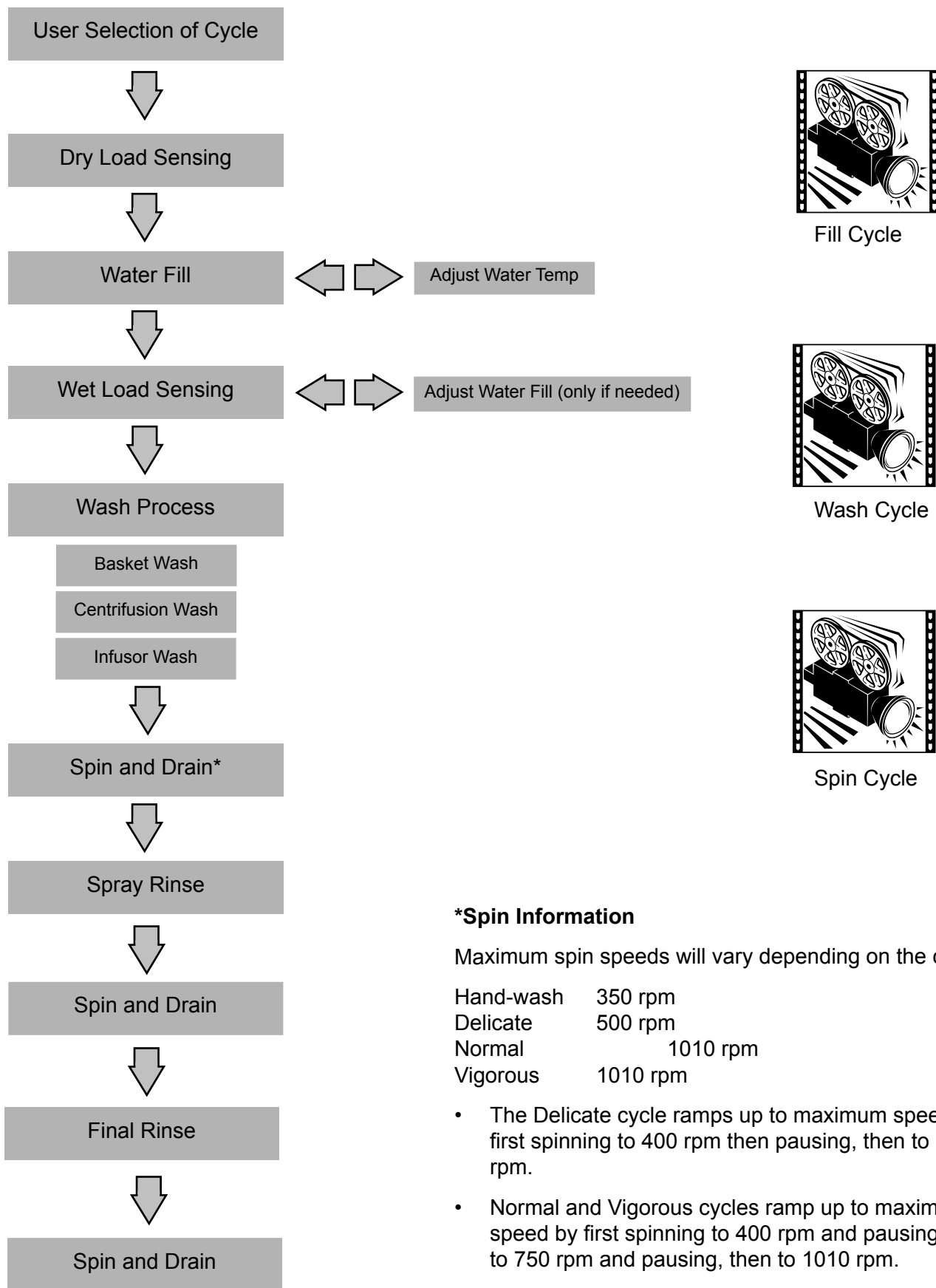

*Spin Information

Maximum spin speeds will vary depending on the cycle:

Hand-wash	350 rpm
Delicate	500 rpm
Normal	1010 rpm
Vigorous	1010 rpm

- The Delicate cycle ramps up to maximum speed by first spinning to 400 rpm then pausing, then to 500 rpm.
- Normal and Vigorous cycles ramp up to maximum speed by first spinning to 400 rpm and pausing, then to 750 rpm and pausing, then to 1010 rpm.

Component Locator Views

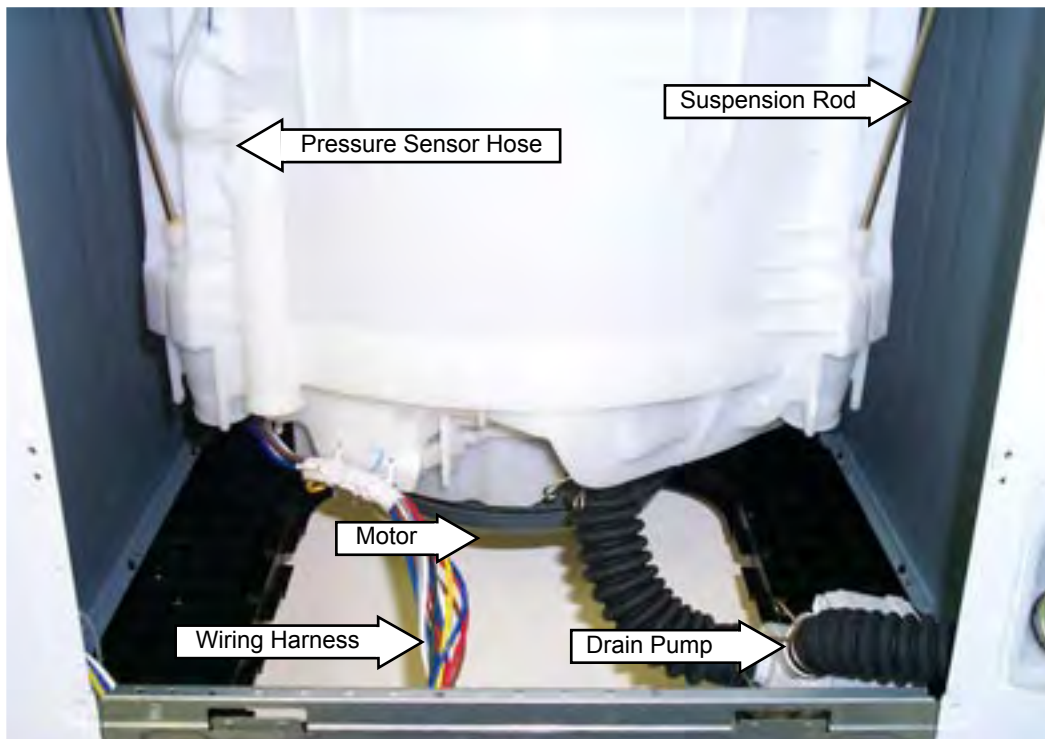
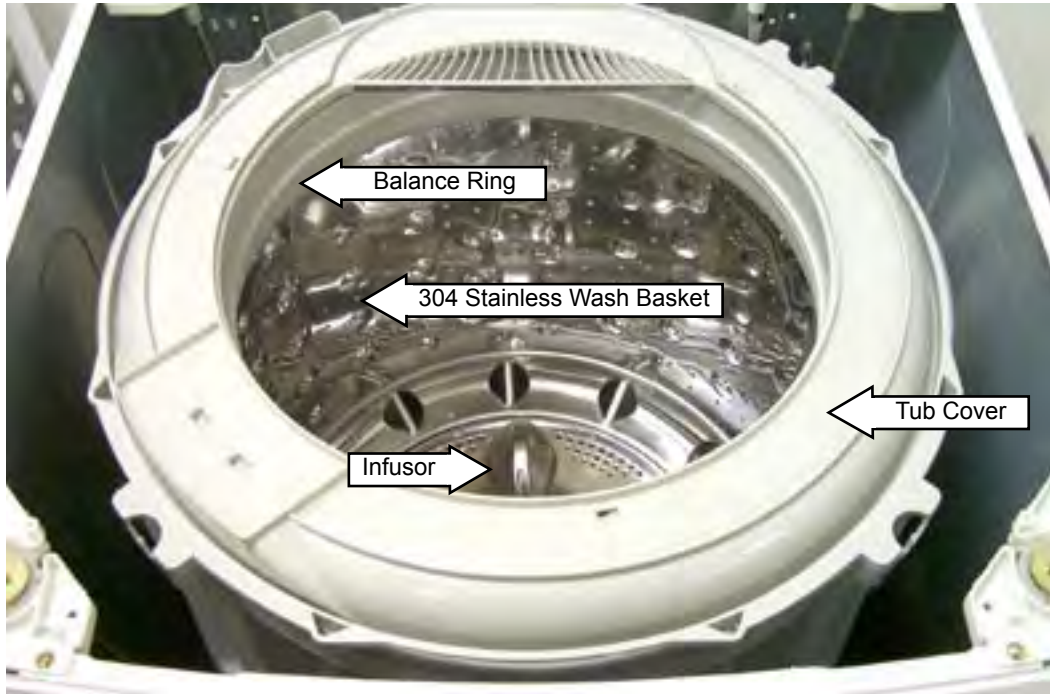

Note: To view the basket while it is in operation, open the lid and place a magnet on the left front corner of the top cover (in front of the bleach dispenser).

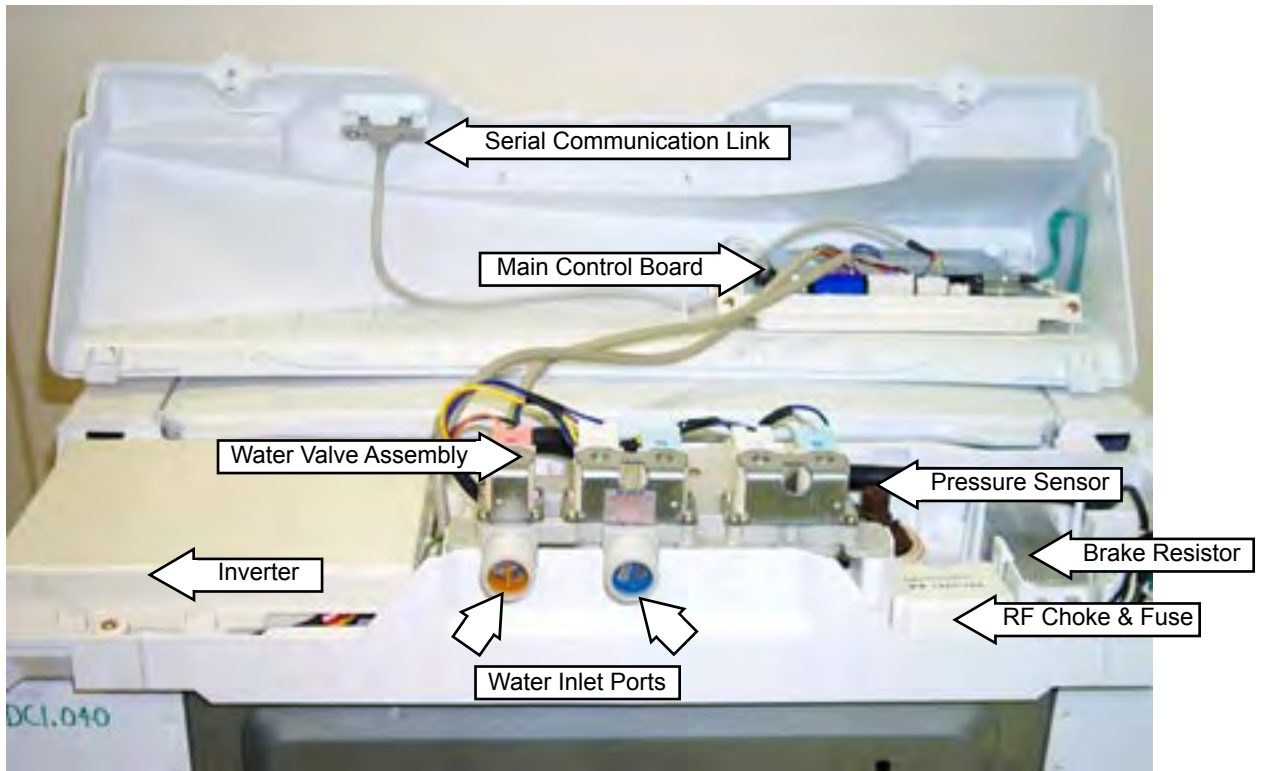
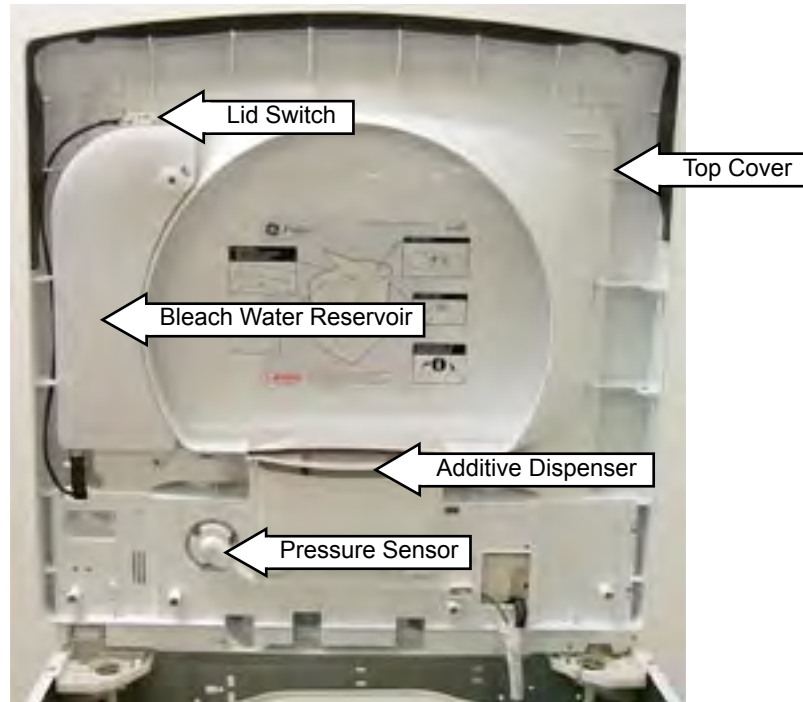
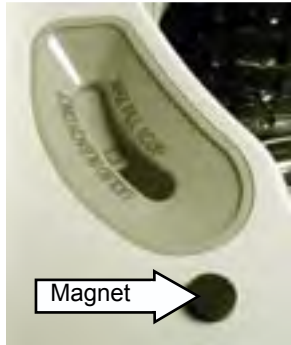

Note: Backsplashes are reversible. Left control backspash shown. See **Switching the Washer and Dryer Backsplashes** for more information.

Inverter and Main Board Pin Connectors

Inverter Board

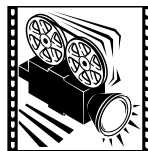
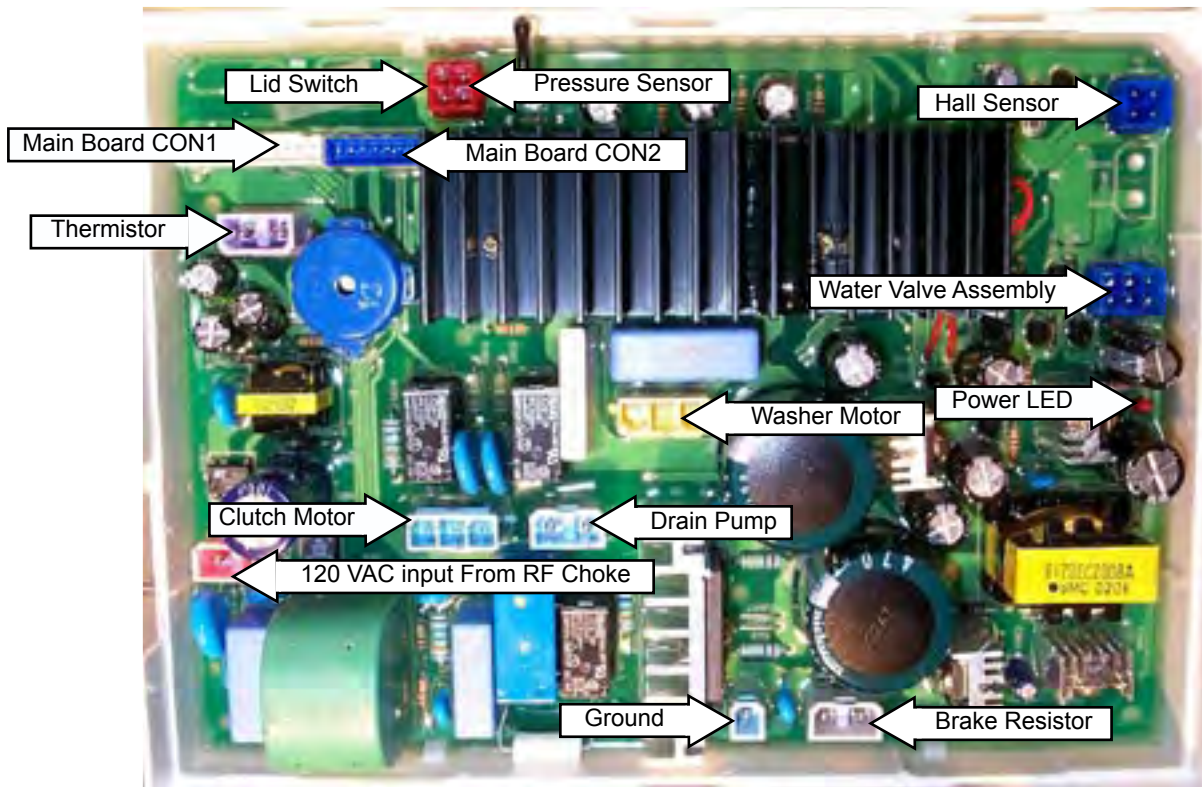

Inverter Board Testing

Main Board

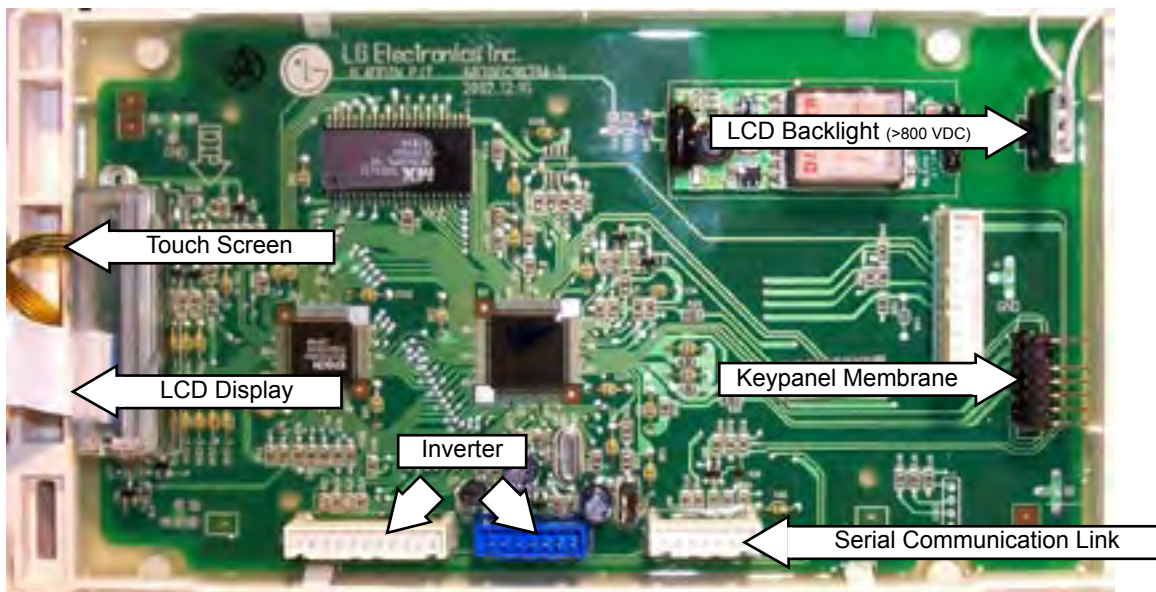

WARNING: THE CONNECTOR AT THE LCD BACKLIGHT IS OVER 800 VDC. USE APPROPRIATE TYPE VOLTMETER OR DAMAGE COULD RESULT.

Washer Components

Backsplash

The backsplash must be removed to access the control system components.

To remove the backsplash:

1. Remove the 2 Phillips head screws that hold the backsplash in place.



2. Place a towel over the lid of the washer to prevent scratches to the surface. Gently lift each corner of the backsplash, then roll it forward so it rests on top of the washer.
3. Disconnect the wiring to the keypanel. Remove the backsplash.

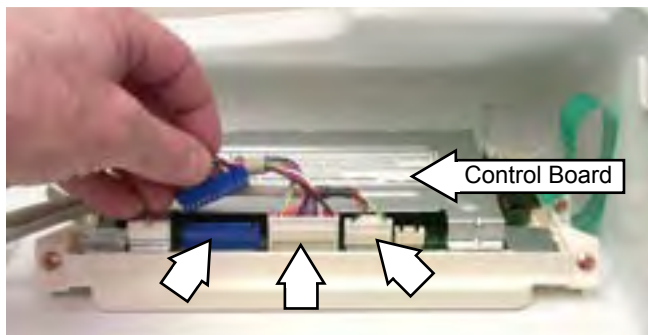

Control System

The washer control system consists of three main components:

- Main control board and touch screen LCD
- Membrane keypanel
- Inverter

Caution: To prevent electrostatic discharge from damaging any electronic components, use an ESD wristband or touch a grounded metal surface before servicing.

Main Control Board and Touch Screen LCD

The main control board and touch screen LCD are attached to the backsplash as one unit. The touch screen LCD and main control board are only available as a complete assembly.

To remove the main control board and LCD touch screen assembly:

1. Remove the **Backsplash**.
2. Disconnect the ribbon at the right of the main control board.

Note: Do not disconnect any other ribbons from the main control board.

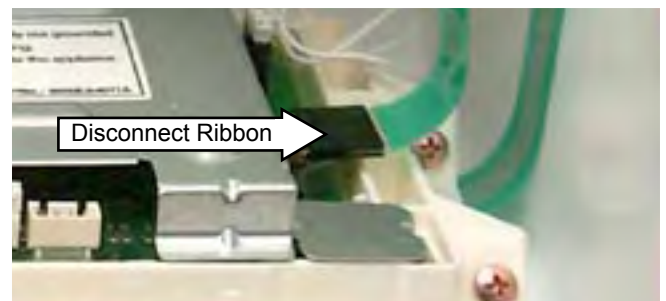

3. Remove the 4 Phillips head screws (2 on each side) that hold the main control board and LCD touch screen assembly in place. Remove the assembly.

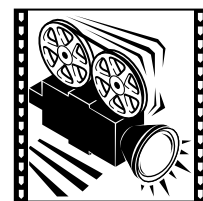

Control Panel Electronics

Membrane Keypanel

The membrane keypanel is attached to the backsplash and is only available as a complete assembly.

When ordering a replacement backsplash, the part must be ordered as *left* or *right*, depending upon installation.

The membrane keypanel is connected to the control board by a ribbon cable.

Membrane Keypanel Test

To test the membrane keypanel, press the appropriate pad and check for continuity ($0\ \Omega$) between the following pins:

Pad	Pins
Power	1 and 3
My Cycles	1 and 4
Back	2 and 3
Help	2 and 4
Home	1 and 7
Start/Stop	1 and 5

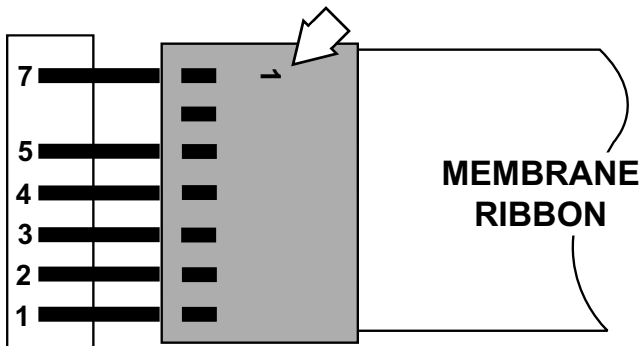

Note: The number (1) molded on the membrane connector is not a pin reference number.

Inverter

The inverter board is enclosed in a protective box mounted on the top cover under the backsplash.

To access and remove the inverter:

1. Follow steps 1 and 2 under **Backsplash**.
2. Remove the 2 Phillips head screws that hold the inverter box in place.

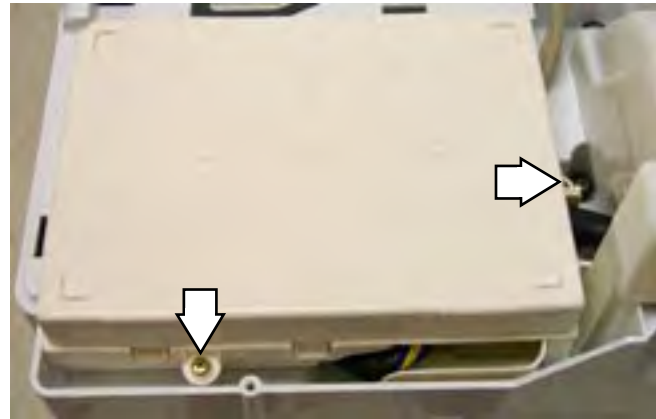

3. Lift the inverter box up. Press the tabs on the side and gently pry it open.

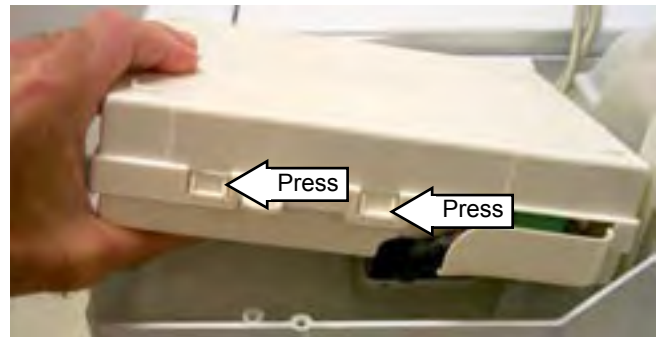

4. Disconnect the wiring from the inverter board. Remove the inverter.

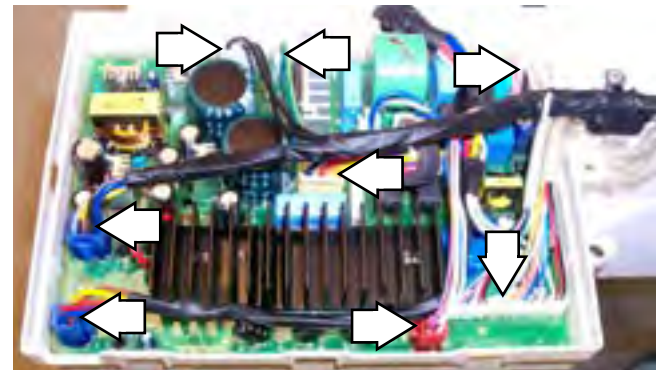

Testing the Inverter

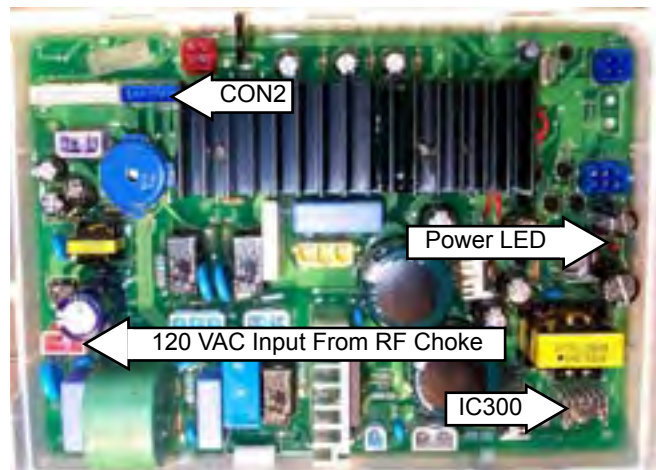

- The inverter receives 120 VAC through the RD2 connector (RF Choke). If 120 VAC is not present, check wall outlet, power cord, and RF Choke.
- The RF Choke filters the line voltage and contains an in-line fuse. It is replaced as an assembly.

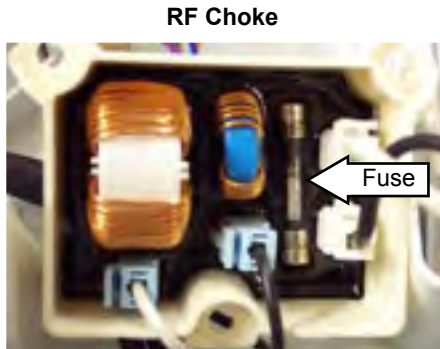

- Whenever the washer is plugged in, there is 5 VDC at pins 1 and 2 on the dark blue 7-pin CON2. (See *Testing the Inverter* photo.)
- When the washer is turned on by pressing a membrane pad or touching the LCD screen, the Power LED on the inverter comes on.
- When the Power LED is on, the 12-VDC power supply on the inverter board is energized and the below listed voltages are on CON2:

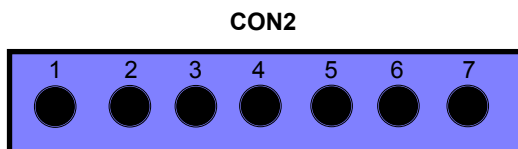

Pins	Voltages
1 and 2	5 VDC
1 and 3	12 VDC
1 and 4	20 VDC

- After 5 minutes, if there is no additional screen input, the washer shuts off and the power LED shuts off. There is no voltage on pins 1 and 3 and 1 and 4 at this time.
- If the washer operates through a cycle, the inverter voltages at CON2 will be present until the lid is opened.
- If the Power LED is lit and any of the three voltages (5 VDC, 12 VDC, 20 VDC) at CON2 are not present, the inverter is bad.

Protective Cover

The protective cover must be removed to access the following components: water valve assembly, pressure switch, brake resistor, RF choke, and fuse. The protective cover is held in place by 3 Phillips head screws.



Brake Resistor

- The brake resistor absorbs energy from the *reversing* of the motor during the brake cycle.
- The brake resistor only operates when the washer is unplugged or the lid is lifted during a cycle.
- Under normal operation, the tub coasts to a stop at the end of a cycle.
- The approximate resistance value of the brake resistor is 70 Ω .
- If the resistor is shorted, the motor will not start.
- If the resistor opens while the motor is spinning, the inverter board can be damaged.
- Look for a burnt IC labeled IC300 on the inverter board. Both the resistor and inverter board should be replaced if the IC300 is damaged. (See *Testing the Inverter* photo.)

To remove the brake resistor:

1. Remove the 2 Phillips head screws that hold the brake resistor in place.
2. Disconnect the wiring to the brake resistor.

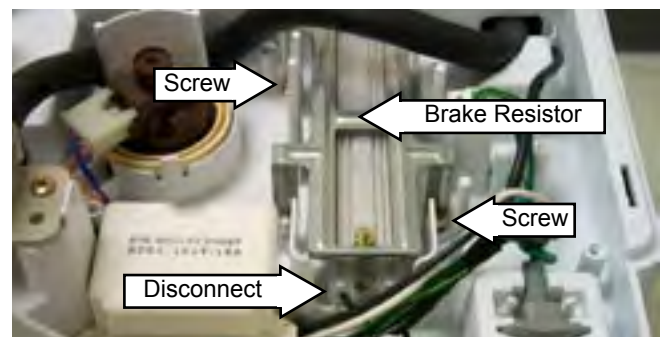

Pressure Sensor (Water Level Switch)

The pressure sensor is connected by a clear hose to an air reservoir near the bottom of the outer tub and operates by a frequency (kHz) signal to the inverter board.

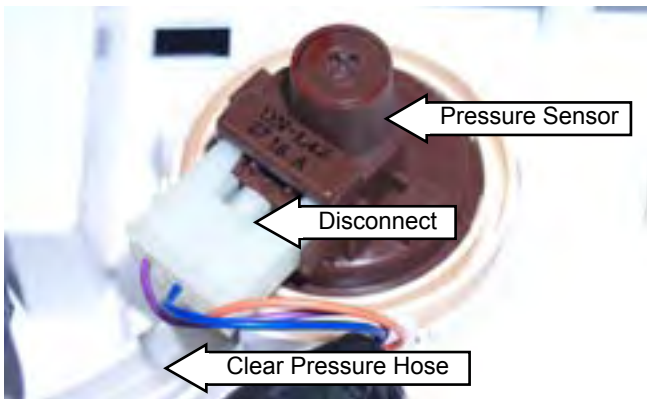

The pressure sensor wires (purple, orange, and blue) are connected at pins 1, 3, and 4 at the 4-pin red connector on the inverter board. (See **Inverter and Main Board Pin Connectors**).

The approximate resistance value of the transducer, measured between the purple and orange wires, is 20 Ω .

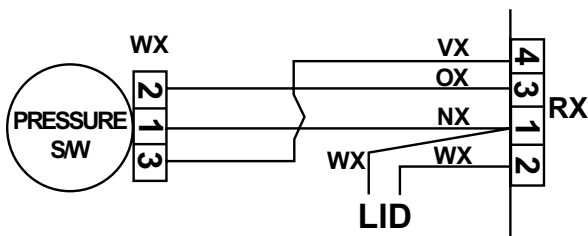

COLOR CODE			
LETTERS	COLOR	LETTERS	COLOR
AX	LT. BLUE	RX	RED
BX	BLACK	SX	GRAY
CX	BROWN	GX	GREEN
NX	DK. BLUE	VX	PURPLE
OX	ORANGE	WX	WHITE
PX	PINK	YX	YELLOW

THE "X" INDICATES ONE SOLID COLOR-NO TRACER. WIRES WITH TRACER SHOW BOTH COLORS, EXAMPLE - WR IS WHITE WITH RED TRACER.

- When the water level rises in the washer tub, air is trapped in the reservoir. As the water level rises, the air pressure in the reservoir increases.
- The pressure is translated into an electrical signal (frequency) by the pressure sensor.
- The frequency will vary from approximately 27 kHz (empty tub) to 22 kHz (full tub).
- This frequency can be measured at the pressure sensor between the purple and orange wires.

The frequency is monitored by the inverter which turns off the water valves when the desired water level is achieved.

Note: The water level will vary depending on the load size which is measured by the dry load and wet load sensing cycles. This information is sent to the inverter, which then determines the appropriate water level.

Pressure Sensor Test

If the pressure sensor is not operating correctly, perform the following test:

1. Set the wash cycle to SNEAKERS. This cycle bypasses the load sensing feature and defaults to the **minimum** water level.
2. Measure the water level from the center hub of the infusor (it should be approximately 2 inches deep in the tub).
3. Set the washer to COMFORTER. This cycle bypasses the load sensing feature and defaults to the **maximum** water level.
4. Measure the water level from the center hub of the infusor (it should be approximately 11 inches deep in the tub).

Note: Before disconnecting the hose from the pressure sensor, be sure the water level is below the bottom of the spin basket.

To remove the pressure sensor:

1. Remove the 2 Phillips head screws that hold the **Backsplash** in place.
2. Place a towel over the lid of the washer to prevent scratches to the surface. Gently lift each corner of the backsplash, then roll it forward so it rests on top of the washer.
3. Remove the 3 Phillips head screws that hold protective cover in place.
4. Disconnect wiring to the pressure sensor.
5. The pressure sensor is held in place by 3 tabs. With a flat blade screwdriver, press the tabs back and lift the water level switch up and out.
6. Disconnect the clear hose from the pressure sensor.

Water Valve Assembly

The water valve consists of a valve body and five solenoid coils. It is only available as a complete assembly. Each solenoid controls a specific water function.

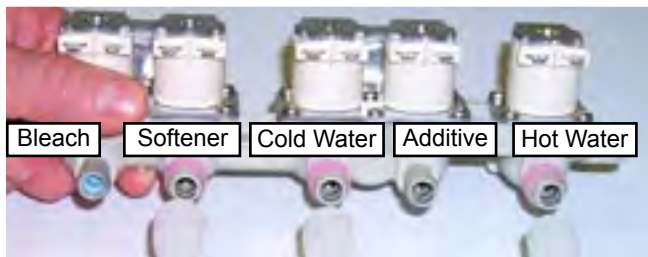
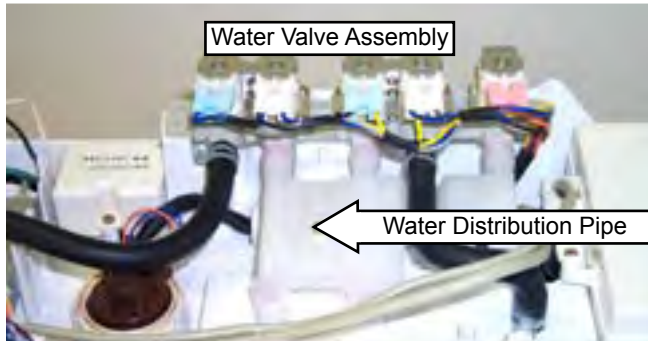

- Each coil on the water valve assembly has an approximate resistance value of 30 Ω.
- The water valves receive power from the inverter. They are connected to the 6-pin blue connector on the inverter board. (See ***Inverter and Main Board Pin Connectors.***)
- When energized, there should be approximately 13-VDC at the appropriate coil.

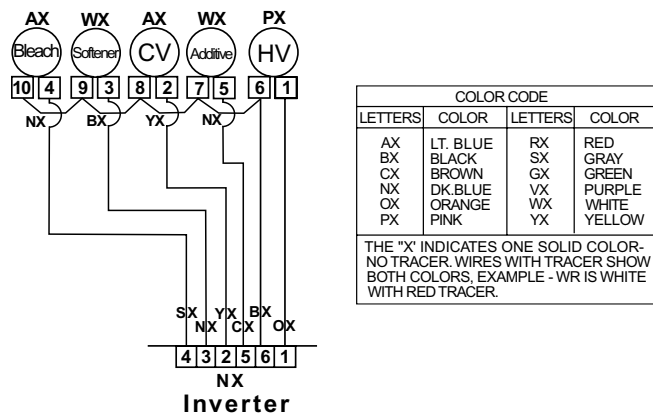

To remove the water valve assembly:

1. Remove the ***Backsplash***.
2. Remove the 3 Phillips head screws that hold protective cover in place.

3. Note the placement of the wires, then disconnect the wiring to the solenoid coils.



4. Remove the 2 water inlet hoses:
 - a. Squeeze each clamp and slide it back.
 - b. Carefully break the hoses loose.
 - c. Remove the hoses.

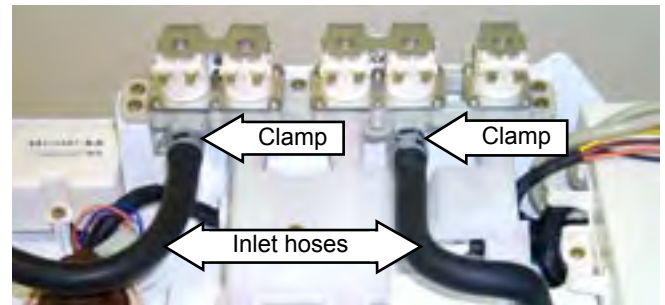

5. Remove the 3 Phillips head screws that hold the water valve assembly in place and the 2 Phillips head screws that hold the water distribution pipe in place.

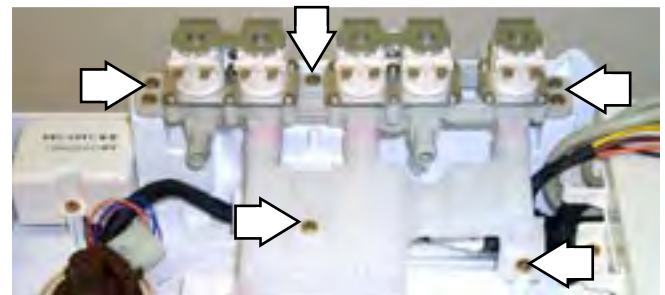

6. Remove the water valve assembly and distribution pipe.

Note: The distribution pipe separates from the water valve assembly as shown below.



Top Cover

The top cover is held in place by 2 Phillips head screws located on the top/back of the washer and two front tabs.

To remove the top cover:

1. Remove the 2 Phillips head screws that hold the top cover in place.



2. Remove the 4 Phillips head screws (2 on each side) that hold the back cover in place. Remove the back cover.



3. Disconnect the pressure sensor hose from the outer tub.



4. The main wiring harness is held in place by plastic clips on the inside corner of the washer cavity. Remove the wiring harness from the holding clips.
5. Remove the screw that holds the ground wire to the upper back cover.



6. Disconnect the four wiring harness connectors.

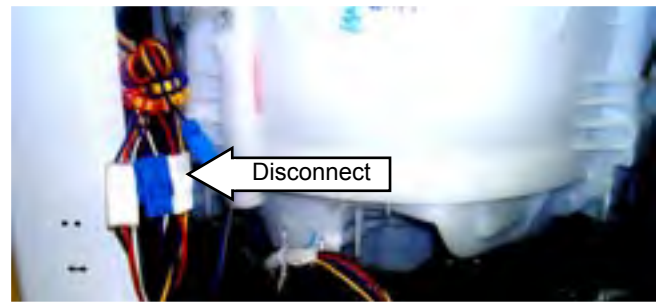

7. Lift the back of the top cover and slide it forward to clear the front tabs. Remove the top cover.

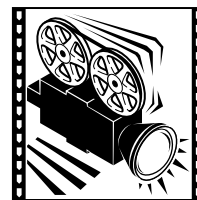

Top Cover Removal

Wash Basket

Caution: If the basket is not free to rotate, damage to the clutch coupler can occur. Ensure that the washer is in the spin mode before removing the wash basket. The wash basket will rotate freely when it is in spin mode. Do not attempt to remove the hub nut if the basket is not free to rotate.

To remove the wash basket:

1. Remove the **Top Cover**.
2. Remove the 8 Phillips head screws that hold the outer tub cover in place.



3. Place a flat-head screwdriver in the slot under the infusor cap and gently pry off.

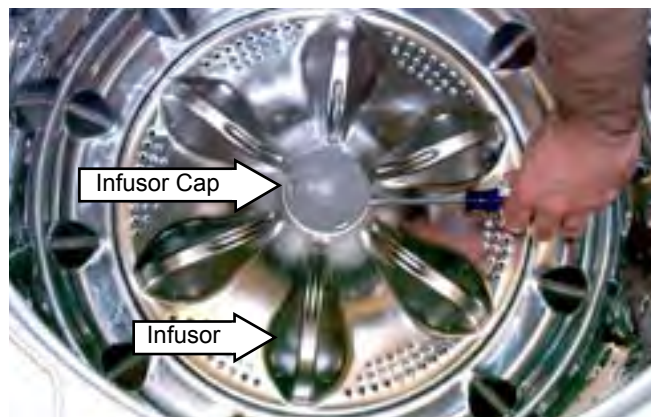

4. Remove the 10-mm hex-head screw that holds the infusor in place with a socket or Phillips head screwdriver (turn screw counterclockwise to remove).

Note: The 10-mm screw has a rubber O-ring.



5. Pull the infusor up and out. **WARNING:** The inner edge can be sharp. Wear Kevlar gloves or equivalent protection.
6. Remove the 37.5-mm (1-1/2" SAE equivalent) hub-nut with a socket or Crescent wrench (rotate hub-nut counterclockwise to remove).

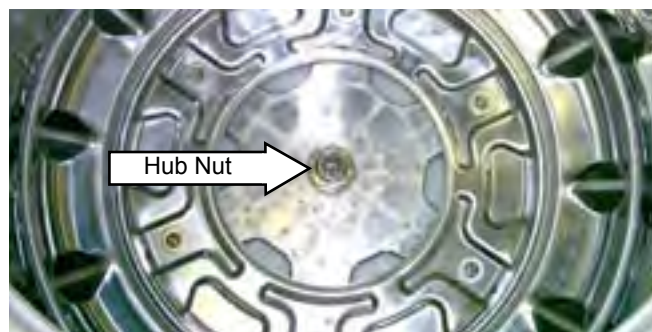

7. Lift the wash basket up and out.

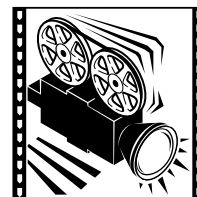

Wash Basket Removal

Drain Pump

- The drain pump consists of a 120-VAC, 60-Hz, motor, impeller, and impeller housing.
- The pump is capable of pumping to a stand-pipe height of 8 ft. The maximum length of the drain hose is 10 ft. (An accessory drain hose extension is not available at this time.)
- The drain pump will operate independently of other mechanical components and will evacuate water at various times during the cycle.
- The drain-pump motor has an approximate resistance value of 11 Ω .
- Pins 1 and 2 on the light blue 2-pin connector on inverter board should measure 120 VAC when drain pump is activated. (See *Inverter and Main Board Pin Connectors*.)

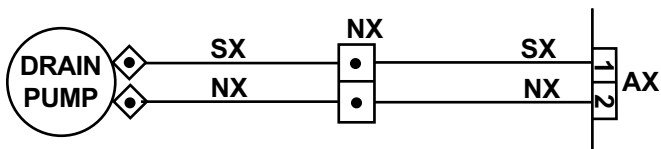

COLOR CODE			
LETTERS	COLOR	LETTERS	COLOR
AX	LT. BLUE	RX	RED
BX	BLACK	SX	GRAY
CX	BROWN	GX	GREEN
NX	DK.BLUE	VX	PURPLE
OX	ORANGE	WX	WHITE
PX	PINK	YX	YELLOW

THE "X" INDICATES ONE SOLID COLOR-NO TRACER. WIRES WITH TRACER SHOW BOTH COLORS, EXAMPLE - WR IS WHITE WITH RED TRACER.

To clean the impeller and impeller housing:

WARNING: The drain pump bracket is not grounded. Unplug the unit before servicing to avoid electric shock.

Note: The impeller can be accessed for cleaning without removing the drain hoses. Water will remain in hoses even when the tub appears empty. Use care to avoid water spills.

1. Disconnect power to the machine.
2. Remove the 4 Phillips head screws (2 on each side) that hold the back cover in place. Remove the back cover.
3. Remove the thin plastic cover over the drain pump by pulling down on the ends to clear the tabs.

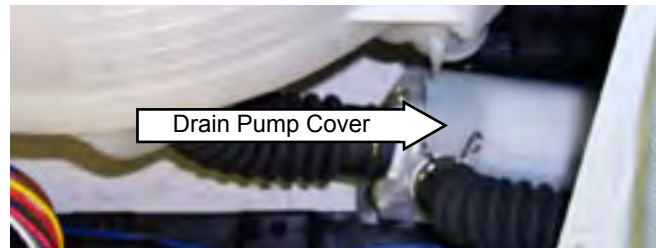

4. Lift up the tab on the impeller housing with a flat-head screwdriver. When viewed from the impeller housing end, rotate the motor in a counter clockwise direction to remove.

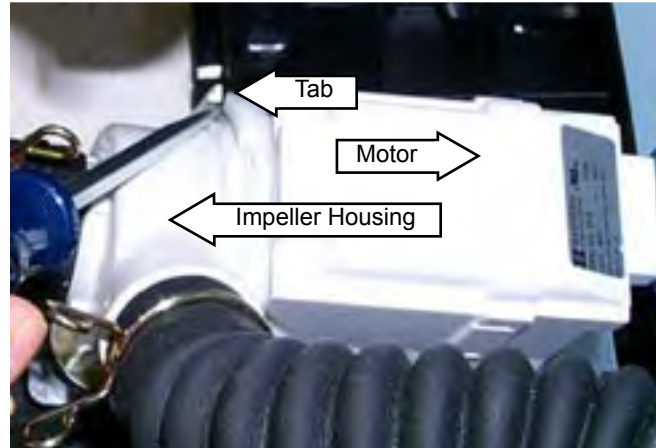

5. Remove any foreign objects from the impeller and impeller housing. Inspect the impeller for any damage and replace the pump assembly if necessary.

To remove the drain pump:

Note: Water will remain in hoses even when the tub appears empty. Use care to avoid water spills.

1. Disconnect power to the machine.
2. Remove the 4 Phillips head screws (2 on each side) that hold the back cover in place. Remove the back cover.
3. Remove the thin plastic cover over the drain pump by pulling down on the ends to clear the tabs.



4. Remove the drain hoses from the pump:

Note: The drain hoses are difficult to remove due to a sealing compound used at the factory.

- a. Squeeze each clamp and slide it back.
- b. Carefully break the hose loose by inserting a small flat-blade screwdriver under the hose to break the seal.
- c. Remove the hose.

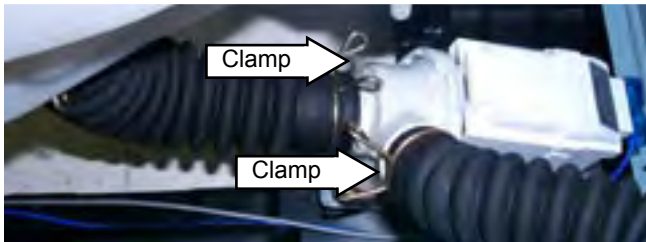

5. Remove the 2 Phillips head screws that hold the drain pump mounting plate to the washer floor.



6. Disconnect the drain pump wires.

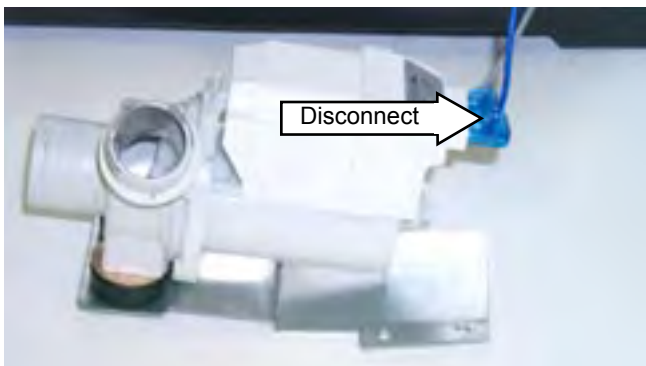

7. Remove the 2 Phillips head screws that hold the drain pump to the mounting plate. Remove the drain pump.

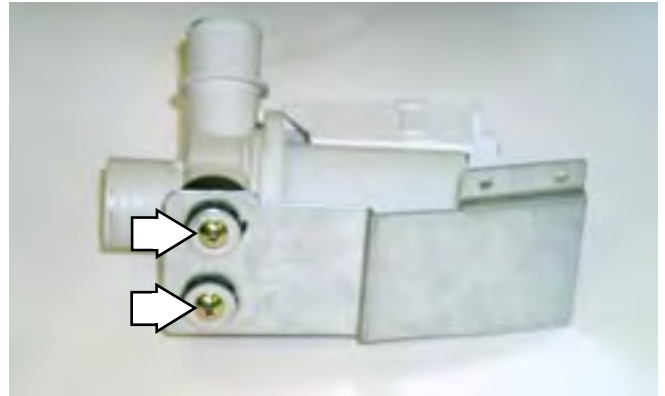

Caution: Care must be taken when reinstalling and sealing the drain hoses to the outer tub to ensure there is no water leakage.

When installing, apply a thin coat of sealing compound (part no. WH60X15) to the inner surface of the drain hoses.

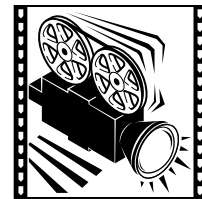

Pump Removal

Thermistor/ATC Control (Auto Temp)

- The control uses a water temperature sensor (thermistor) to regulate the wash water temperature.
- The thermistor has a negative temperature coefficient (as temperature increases, resistance decreases).
- The thermistor is located in the bottom of the outer tub under the wash basket.

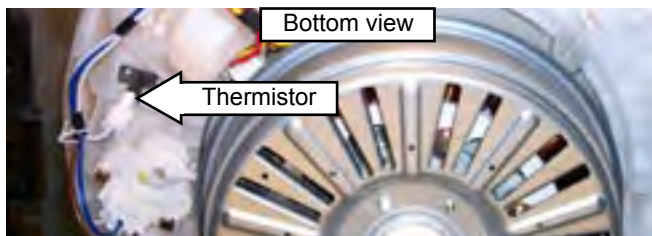

To determine the temperature of the incoming water, the washer control measures the difference between the voltage sent and the voltage returned from the water temperature sensor. The washer control then makes temperature adjustments accordingly.

The washer control should maintain the water temperature in the tub within +/- 5°F (3°C) by opening or closing the hot and cold water valves.

The thermistor has an approximate resistance value of 121K Ω at 70°F (21°C).

Approximate resistance values at:

- 60F° (16C°) - 141K Ω
- 80F° (27C°) - 86K Ω
- 105F° (40C°) - 48K Ω
- 120F° (49C°) - 35K Ω

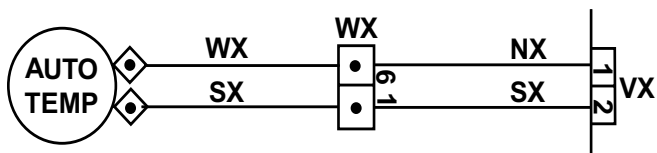
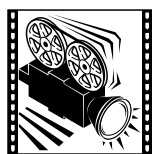

COLOR CODE			
LETTERS	COLOR	LETTERS	COLOR
AX	LT. BLUE	RX	RED
BX	BLACK	SX	GRAY
CX	BROWN	GX	GREEN
NX	DK. BLUE	VX	PURPLE
OX	ORANGE	WX	WHITE
PX	PINK	YX	YELLOW

THE "X" INDICATES ONE SOLID COLOR-NO TRACER. WIRES WITH TRACER SHOW BOTH COLORS, EXAMPLE - WR IS WHITE WITH RED TRACER.

Resistance can be measured at the purple 2-pin connector on the inverter board. Make sure to unplug the connector to isolate the thermistor before taking resistance readings. (See *Inverter and Main Board Pin Connectors*.)

To remove the thermistor:

1. Remove the 4 Phillips head screws (2 on each side) that hold the back cover in place. Remove the back cover.
2. Disconnect the wiring connector at the thermistor.
3. Remove the 2 Phillips head screws that hold the thermistor to the bottom of the outer tub. Remove the thermistor.

Outer tub and Suspension Assembly

The wash basket, outer tub, and motor are suspended by four rod and spring assemblies. The rod and spring assemblies are attached to each corner of the washer cabinet. They extend down and connect to the bottom of the outer tub.

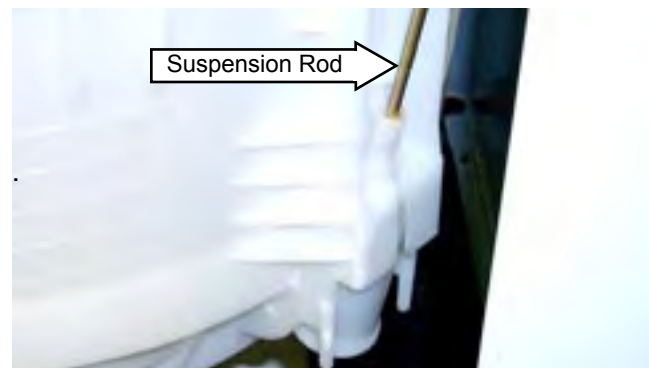

To remove the outer tub:

WARNING: The outer tub assembly is heavy and requires two people to remove it from the washer housing. Care should be taken when removing and installing the outer tub assembly.

1. Remove the *Top Cover*.
2. Remove the drain hose from the outer tub:

Note: Water will remain in hoses even when the tub appears empty. Use care to avoid water spills.

- a. Squeeze the clamp and slide it back.
- b. Carefully break the hose loose.
- c. Remove the hose.

- Lift the outer tub up and disengage the suspension rod assemblies from each corner of the outer tub.

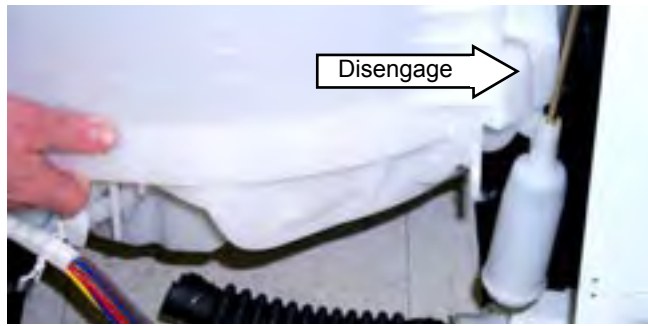

- Pull the outer tub assembly out of the washer cabinet.

Caution: Care must be taken when reinstalling and sealing the drain hoses to the outer tub to ensure there is no water leakage.

Motor Assembly

- The washer has a direct drive pulse width modulation motor that does not utilize a belt, transmission, or mechanical brake.
- The motor assembly is composed of a coil wound stator, Hall sensor, and permanent magnet rotor.
- The motor varies speed and torque when the pulse width modulated voltage from the inverter changes frequency.
- The motor reverses rotational direction when the inverter reverses electrical polarity to the motor.

The washer motor has an approximate resistance value of 8Ω between any two of the three wires:

- Blue to red - 8Ω
- Red to yellow - 8Ω
- Blue to yellow - 8Ω

Resistance can be measured at the yellow, 3-pin connector on the inverter board or at the motor. (See *Inverter and Main Board Pin Connectors.*)

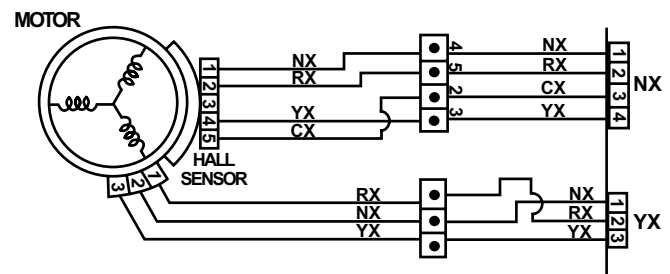
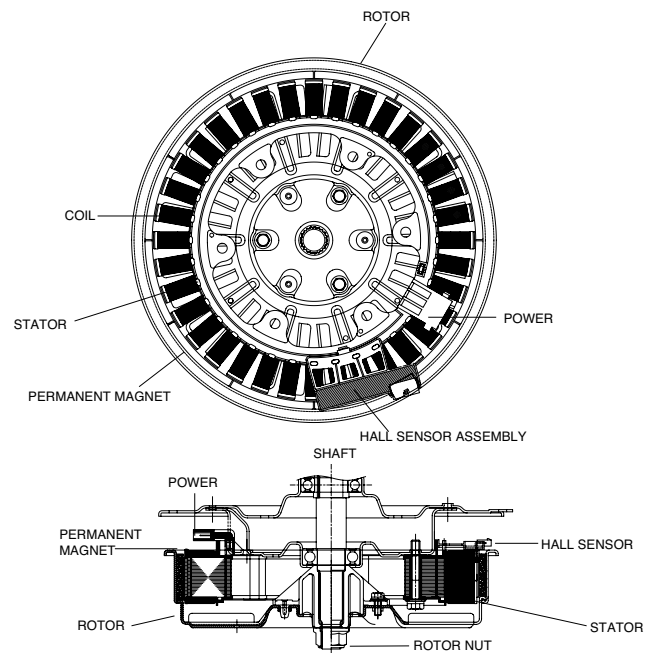

COLOR CODE			
LETTERS	COLOR	LETTERS	COLOR
AX	LT. BLUE	RX	RED
BX	BLACK	SX	GRAY
CX	BROWN	GX	GREEN
NX	DK.BLUE	VX	PURPLE
OX	ORANGE	WX	WHITE
PX	PINK	YX	YELLOW

THE "X" INDICATES ONE SOLID COLOR-NO TRACER. WIRES WITH TRACER SHOW BOTH COLORS. EXAMPLE - WR IS WHITE WITH RED TRACER.

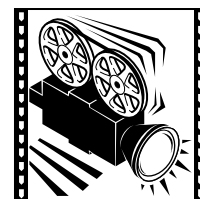

Motor Removal

(Continued Next Page)

Hall Sensor

- The Hall effect sensor measures the motor rpm.
- Four wires connect the Hall sensor to the inverter board at the 4-pin dark blue connector. (See ***Inverter and Main Board Pin Connectors***.)
- The Hall sensor measures approximately 9K Ω between the brown and blue wires and the brown and red wires.
- If the sensor has failed, the motor will not operate.
- The Hall sensor is part of the stator assembly. It is not available as a separate part.

To check the Hall sensor voltage at the inverter:

- Disconnect the Hall sensor plug from the inverter board. Check voltage on pins 3 (brown) and 4 (yellow) on the inverter board. There should be approximately 12 VDC. If not, the inverter board is bad.

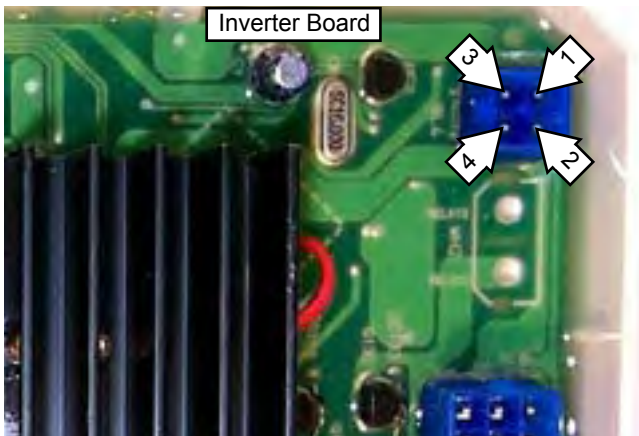

To remove the rotor and stator:

WARNING: The rotor is not grounded. Unplug the washer before servicing to avoid electrical shock

1. To access the motor, the washer must be placed on its side. Place a towel or blanket on the floor to prevent scratches to the surface of the washer.
2. Remove the 24-mm ($15/16$ in. SAE equivalent) rotor nut with a socket or open end Crescent wrench (rotate rotor nut counterclockwise to remove).

Note: Use a rubber mallet if needed to tap the wrench to break the nut free.

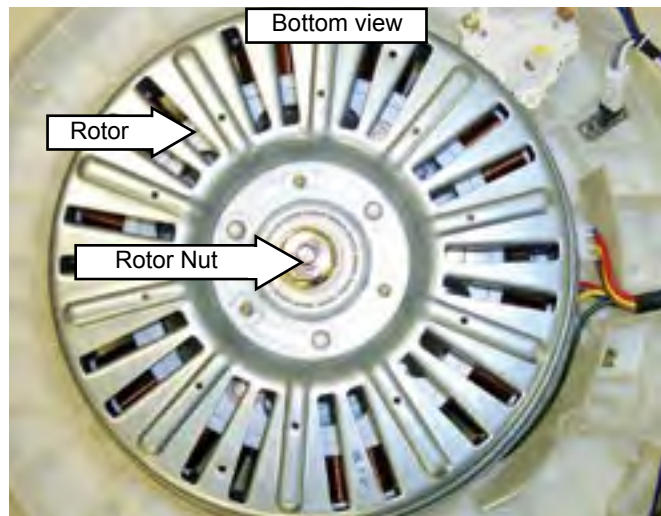

To check voltage at the Hall sensor:

- Measure between pins 1 (blue) and 4 (yellow) and pins 2 (red) and 4 (yellow) with the Hall sensor plugged into the inverter board. Rotate the spin basket by hand. There should be 12-VDC pulses as the basket is rotated. If pulses are present, the Hall sensor is good.

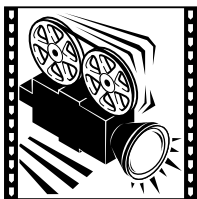

Hall Sensor Operation

3. Pull the rotor away from the drive shaft.
4. Remove the six 10-mm hex-head screws that hold the stator in place.

Note: Removal of the wiring guard (held in place by one 10-mm hex-head screw) will give better access to the motor connector.

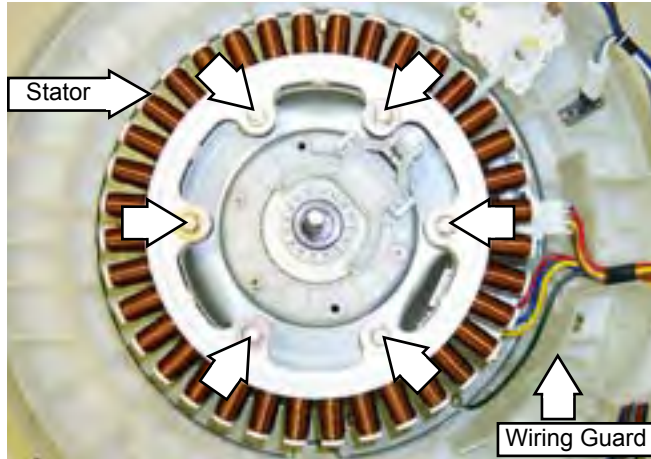

5. Disconnect the wiring to the stator and the Hall sensor by carefully lifting up the stator.

IMPORTANT: The motor connector and Hall sensor connector are very fragile, handle with care.

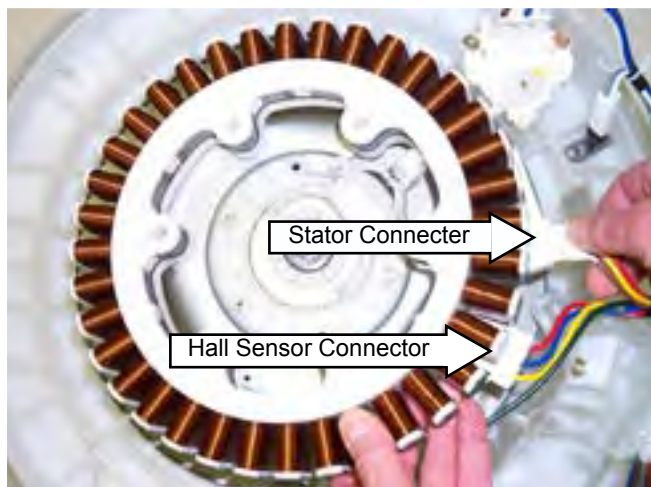

Note: When reassembling, be sure to put the motor and Hall sensor wires back in the wiring guard away from the motor.

Clutch Shifter Assembly

The clutch assembly locks or unlocks the basket and infusor together, depending on the wash cycle pattern. (See **Basic Wash Cycle** for a brief description of wash cycles.)

- The infusor is connected directly to the motor shaft. Whenever the motor is rotating, the infusor is rotating.
- The clutch only locks or unlocks the wash basket.

When the washer first starts a cycle, the infusor moves back and forth several times to make sure the basket and infusor are in the unlocked position before starting. This action is called “clutching” and confirms that the clutch motor is in the unlocked position.

Note: Wash cycle patterns will vary depending on user time adjustments, soil level adjustments, fabric types, and wash-load weights.

The infusor and basket are in the **locked** position during the following cycles:

- Water Fill
- Wet Load Sensing
- Basket Wash
- Centrifusion Wash
- Spin
- Spray Rinse

The infusor and the basket are in the **unlocked** position during the following cycles:

- Dry Load Sensing
- Infusor Wash

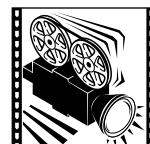

Coupling Operation

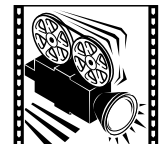

Clutch Motor Operation

(Continued Next Page)

Clutch Operation

- The clutch locks and unlocks the basket by engaging teeth on the inside of the rotor with teeth on the clutch coupler.
- When the basket and infusor are in the locked position, the clutch moves downward and engages the rotor and clutch coupler teeth allowing the basket to rotate with the infusor.

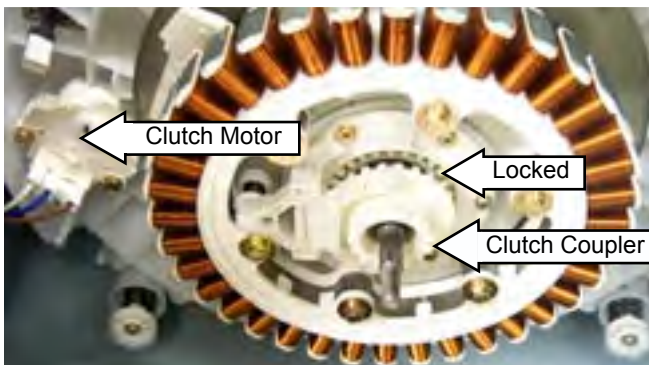
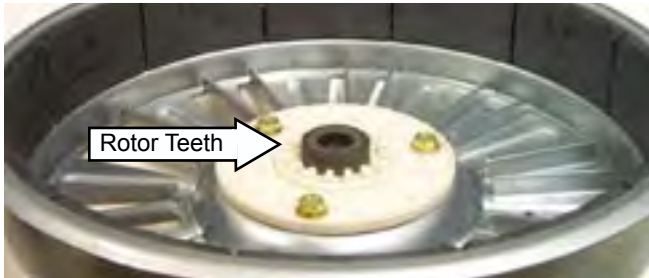

- When the basket and infusor are in the unlocked position, the clutch moves upward, disengaging the clutch coupler and rotor teeth, allowing the infusor to rotate independently of the basket.

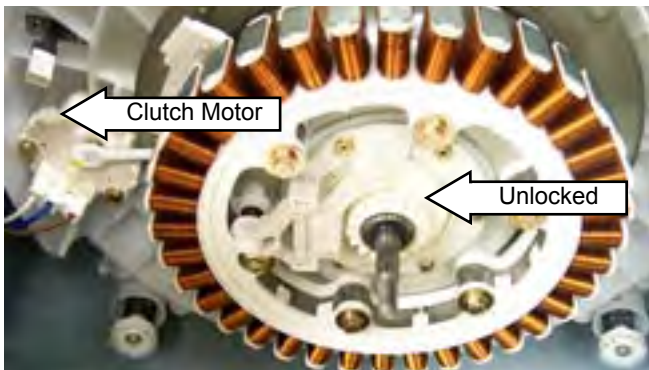

To diagnose the clutch motor:

- The inverter supplies 120 VAC to the clutch motor through the brown and white wires when the clutch motor changes position.

Note: Disconnect power and unplug the clutch motor connector at the inverter board.

- The clutch motor has an approximate resistance value of 2000 Ω . This can be measured between the white and brown wires on the inverter board. (See *Inverter and Main Board Pin Connectors*.)
- The rotation of the clutch motor causes an internal switch to open or close. This can be measured between the brown and blue wires on the inverter board.
- When the clutch is in the unlocked position the switch should be closed (0 Ω).
- When the clutch is in the locked position the switch should be open (infinity).

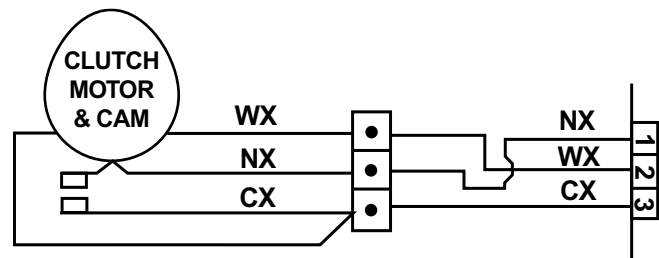

COLOR CODE			
LETTERS	COLOR	LETTERS	COLOR
AX	LT. BLUE	RX	RED
BX	BLACK	SX	GRAY
CX	BROWN	GX	GREEN
NX	DK.BLUE	VX	PURPLE
OX	ORANGE	WX	WHITE
PX	PINK	YX	YELLOW

THE "X" INDICATES ONE SOLID COLOR-NO TRACER. WIRES WITH TRACER SHOW BOTH COLORS, EXAMPLE - WR IS WHITE WITH RED TRACER.

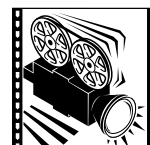

Clutch Coupling and Motor Removal

To remove the clutch shifter assembly:

1. Remove the rotor. (See *Motor Assembly*.)
2. Remove the three Phillips head screws from the clutch coupler plate.

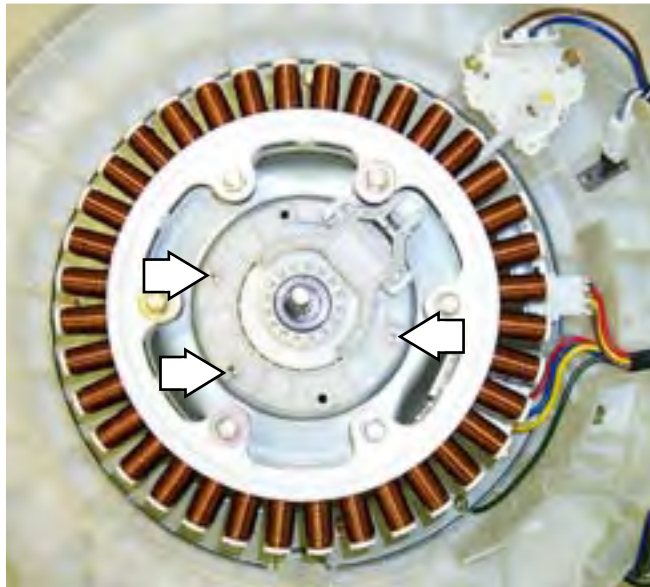

3. Remove the clutch coupler assembly.
4. Disconnect the wiring connector from the clutch motor.
5. Remove the two 10-mm hex-head screws that hold the clutch motor in place. Remove the clutch motor.

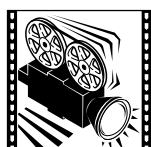
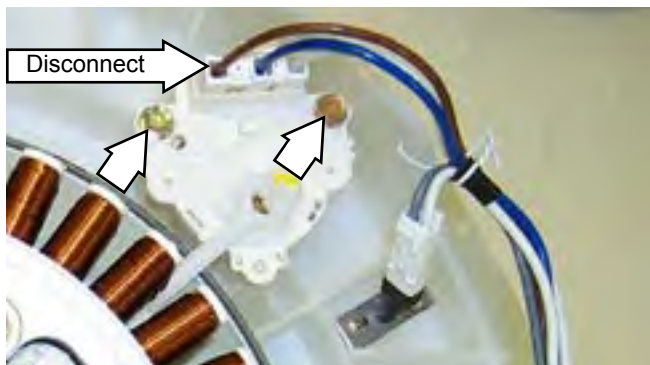

Bearing Assembly Design

Bearing Housing Assembly

To remove the bearing housing Assembly:

1. Remove the *Motor Assembly* and *Clutch Shifter Assembly*.
2. Remove the screw that holds the ground wire to the bearing housing. Remove all the 10-mm hex-head screws on the bearing housing assembly

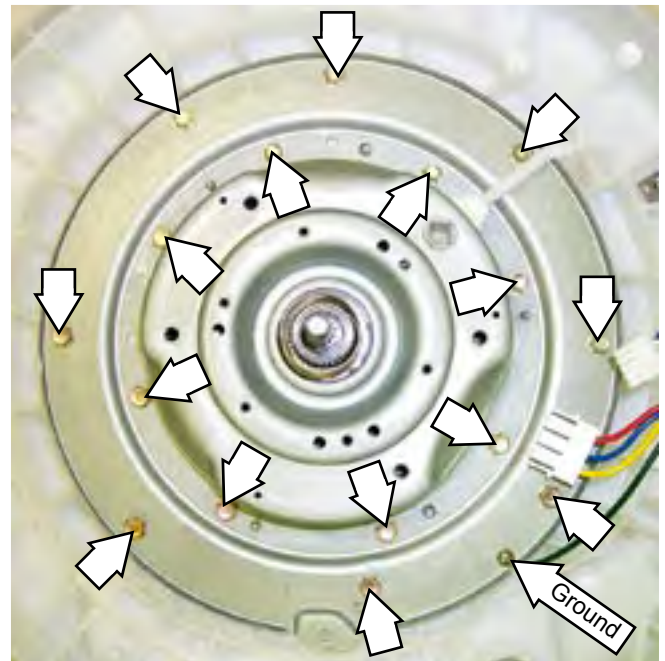

4. Remove the bearing housing assembly.



Note: When reassembling, be sure to put the motor and Hall sensor wires back in the wiring guard away from the motor.

Field Service Mode

Overview

The washer control has a field service mode that can be accessed by the service technician in order to give critical information on the status of various components of the washer. This mode will aid the service technician in quickly identifying failed or improper operation of components and systems.

The service mode does not use error codes to identify problems. Instead, the LCD screen displays a list of components or systems to be checked if a problem is detected.

To enter the service mode:

Note: Once the service mode is entered, all membrane keypad buttons are disabled.

1. Press the POWER key to turn the washer on.
 - a. If the washer is on and the HOME screen is displayed, proceed to step 2. If the home screen is not displayed, press HOME on the keypad.



2. Press HELP. The main help screen is displayed.

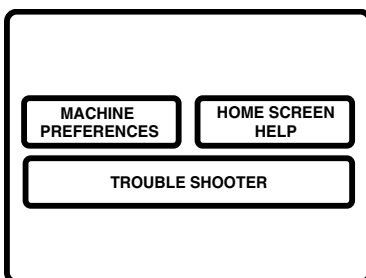

3. Press and hold MY CYCLES and BACK simultaneously for 3 seconds:

- The control will display any recorded errors. If no errors have been recorded, press EXIT to return to the HOME screen.

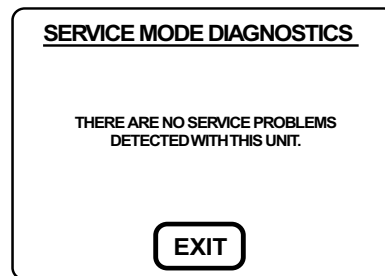

4. If errors have been recorded, use the error chart in the troubleshooting section for proper diagnostic procedures.

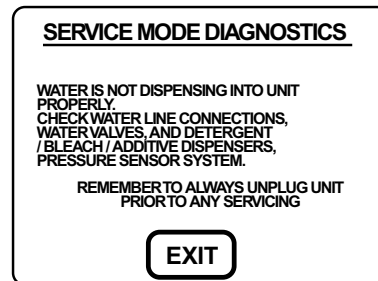

- A MORE icon will be displayed on the LCD screen if additional problems have been recorded. Press MORE to list additional errors.

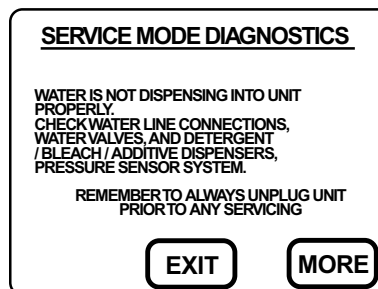

- Use the BACK pad on the keypad membrane to scroll back through the list. If MORE is not displayed then there are no additional errors.

5. If errors have been recorded, the following steps **MUST** be performed.
 - a. Make a note of the listed errors. Press EXIT, the screen prompts you to unplug the washer before servicing.

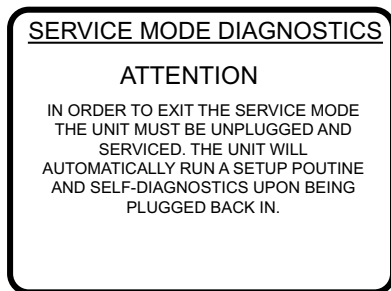

Note: Pressing exit clears all error messages and activates the setup mode program.

- b. Disconnect power and make necessary repairs.
- c. After the problem has been identified in service mode and repairs have been made, the unit prompts the service technician to run a setup/self diagnostic check. The self diagnostic check consists of a series of system tests to ensure the washer is operating correctly. Follow the on-screen instructions.



List of self diagnostic checks:

- Lid
- Touch Screen
- Beeper
- Keypanel Buttons
- Sensors
- Water System
- Drive System
- Serial Communication Link

IMPORTANT: Always disconnect power, reconnect power, and run the setup/self diagnostic mode prior to leaving the house. If this process is not completed and a power outage should occur, the setup/self diagnostic mode screen will be displayed for the customer. This may generate a second service call when no problem exists.

- d. When all errors have been corrected and the setup/self diagnostic mode has been completed, the washer displays the following screen.



- e. Press OK to return the washer to normal operation.

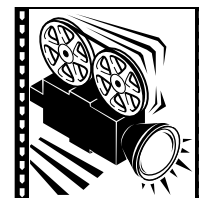

Service Mode

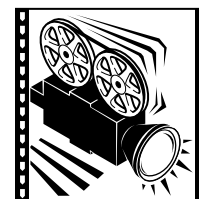

Setup Mode

Factory Test Mode

The factory test mode allows the service tech to make adjustments and run several important tests on critical washer components.

1. Press the POWER pad to turn the washer on. Press the HOME pad to ensure the home screen is displayed.



2. Press the HELP pad. The main help screen is displayed.

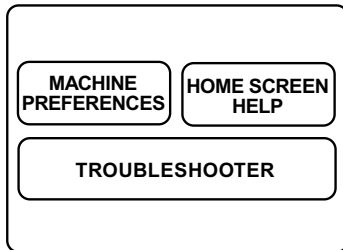

3. Press the HELP and START/STOP pads simultaneously for 3 seconds. The Factory Test Mode screen is displayed.
4. Press TEST LOAD on the LCD screen.

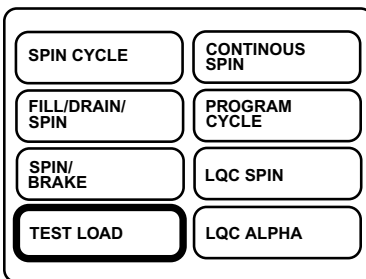

5. The contrast screen is displayed. This test shows screen resolution, which affects how the washer's graphics are displayed. Press the START/STOP pad once to cycle through the contrast screen (the black flips to the opposite side).

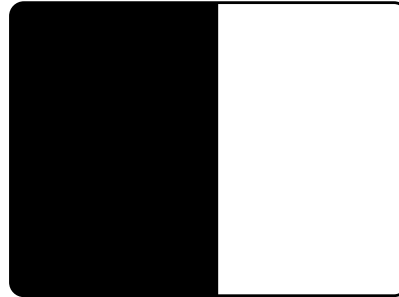

6. Press the START/STOP pad. The TEST LOAD screen is displayed.

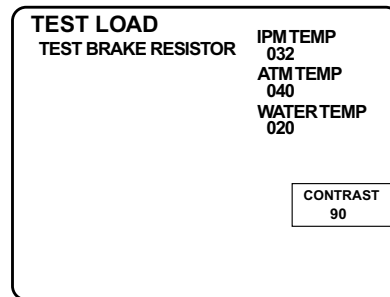

7. Using the test load screen:

Note: Read this section completely before using the TEST LOAD screen.

- a. Press the START/STOP pad to scroll through the test list.

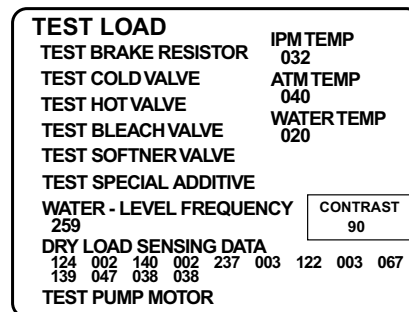

- b. To stop the current test and move to the next test, press the START/STOP pad.
 - c. Each test starts as soon as it is displayed on the screen and each test will time out after 5 minutes if the START/STOP pad is not pressed again.
 - d. To exit the TEST LOAD screen, press START/STOP to scroll down the test list until the screen darkens. Press any pad on the keypad membrane and the HOME screen is displayed.
 - e. Once a test has been started, previous tests cannot be accessed again. To access the TEST LOAD screen again, repeat steps 1 through 6.
- TEST BLEACH VALVE - Energizes bleach valve.
 - TEST SPECIAL ADDITIVE - Energizes special additive valve.
 - WATER LEVEL FREQUENCY - Factory test only, no value as a service test.
 - DRY LOAD SENSING DATA - Factory test only, no value as a service test.
 - TEST PUMP MOTOR - Energizes the drain pump. (Washer lid should be closed.)
 - COM TEST - Part of a serial communication test between the washer and dryer. This test runs a self diagnostic of the internal communications within the main board. Should the test fail, the LCD screen displays COM ERROR when the TEST SOFTENER VALVE test is activated. This is displayed above the CONTRAST 90/180 box. Replace the main board if COM ERROR is displayed.

Factory Test Information

Note: The lid can be open during all tests except for the pump motor test.

The IPM TEMP, ATM TEMP, and WATER TEMP tests are activated as soon as the TEST LOAD screen is displayed. All other tests will time out after 5 minutes.

- TEST BRAKE RESISTOR - The control measures a voltage drop across the resistor. An error is displayed if the resistor fails the test.
- IPM TEMP - Displays the inverter board temp in °C.
- ATM TEMP - Displays the air temperature within the inverter housing in °C.

Note: This temperature affects the LCD display. If the temperature is below 30°F (-1°C) the LCD backlight will not come on.

- WATER TEMP - Displays the water temperature in °C at the tub thermistor.
- CONTRAST 90/180 - Displays current screen resolution of 90 or 180. This can be changed by pressing the CONTRAST box on the LCD screen.
 - 180 - High Contrast (dark)
 - 90 - Low Contrast (light)
- TEST COLD VALVE - Energizes the cold water valve.
- TEST HOT VALVE - Energizes the hot water valve.

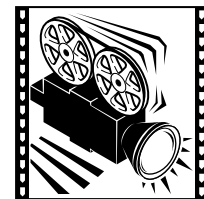

Factory Test Mode

Control Quick Reference Chart

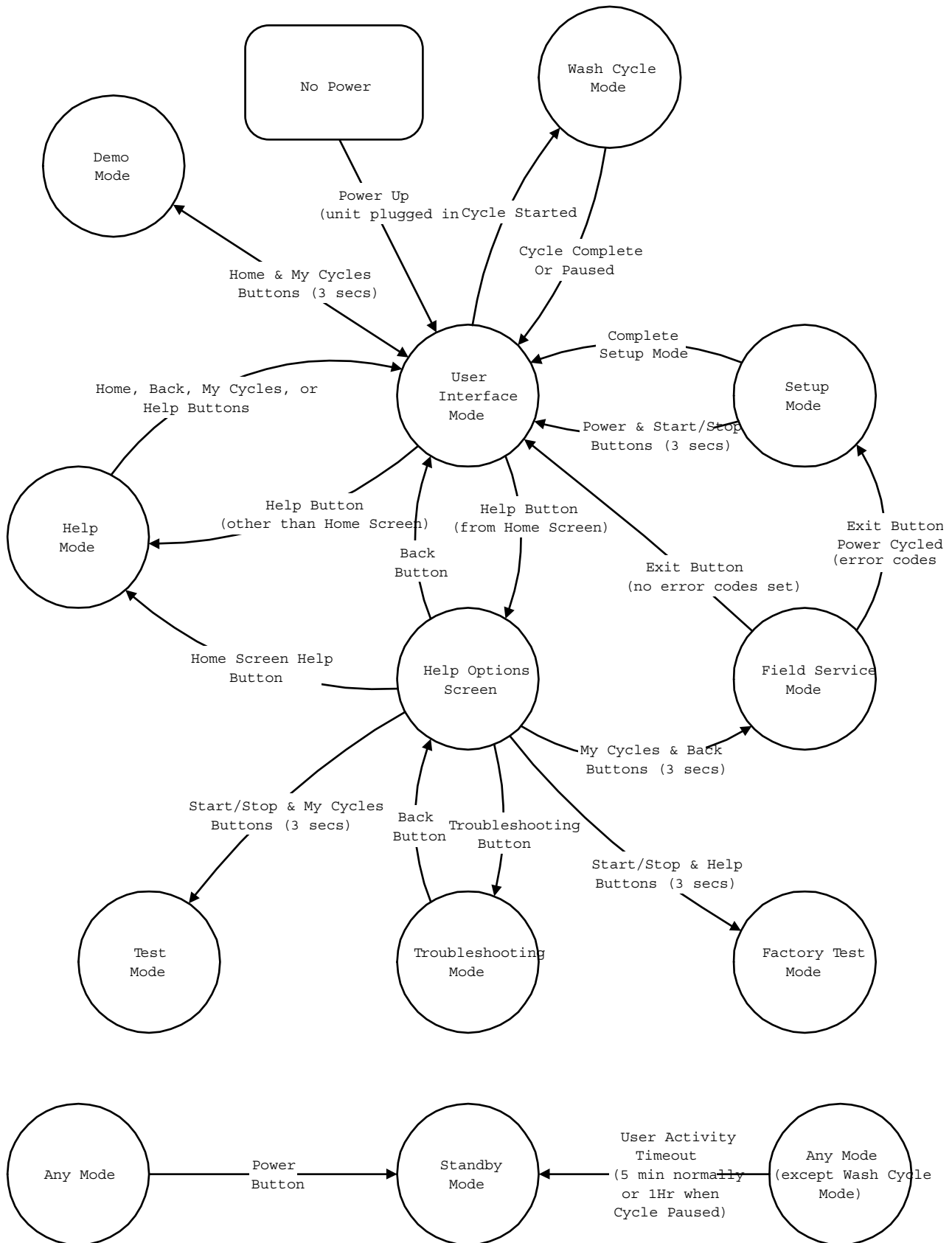

Troubleshooting

Problem	Possible Cause and Repair
<p>LCD backlight does not come on.</p>	<p>The backlight connection on the main board may not be secure. Check the connection to make sure it is secure. The LCD backlight does not function below 30°F (-1.1°C).</p>
<p>Vertical lines on the LCD display when the washer is turned on.</p> 	<p>Re-seat LCD ribbon cable at connector CN6 on the main board. If necessary, a piece of Scotch tape may be added to the back of the ribbon. This additional thickness will provide better contact for the ribbon terminals.</p>
<p>LCD screen too dark or too light as compared to LCD dryer screen.</p>	<p>LCD refresh rate can be changed in Factory Test Mode. (See Contrast setting.)</p>
<p>Replacement LCD screen too dark or too light. LCD refresh rate is matched to inverter output at the manufacturer.</p>	<p>Can occur when LCD screen is replaced. New LCD screen must also be set to inverter output. Adjust the refresh rate through the Factory Test Mode. (See contrast setting.)</p>
<p>Touch screen pad activates an adjacent function incorrectly, i.e. - Pressing one pad activates a function of another pad.</p>	<p>The LCD display ribbon connection on the main board may not be secure. Check the connection to make sure it is secure.</p>
<p>Checkerboard pattern in MY CYCLES screen.</p>	<p>Electrostatic discharge on main board. Enter MY CYCLES and press DELETE on the touch screen LCD, this will clear the checkerboard pattern.</p>
<p>Scuff marks on the plastic backspash or cover (Platinum models).</p>	<p>Can be removed by appliance polish, part no. WR97X216 or a high quality of automotive paste wax.</p>
<p>Motor will not rotate in Demo Mode (motor pulses).</p>	<p>On some models there is a software algorithm issue. Add enough water to the tub so the pressure sensor changes frequency.</p>

(Continued Next Page)

PROBLEM	ERROR DISPLAYED FOR CUSTOMER	ERROR DISPLAYED IN SERVICE MODE	POSSIBLE CAUSE(S)	POSSIBLE REPAIR REQUIRED
Flash ROM EEPROM	No error displayed. Washer will continue to operate normally unless checksum errors are found on parameters critical to safe operation of the unit. Standard problem screen will be displayed if unsafe condition exists.	Screen will display "FLASH ROM is reading or writing improperly"	Checksum errors have been found. Data is not being stored correctly in control.	1.) Main control board
Thermistor	No error displayed. Unit will default to hot water only for hot setting, both hot and cold water for warm setting and cold water only for cold and very cold setting.	Screen will display "There is a problem with the thermistor. Please check and replace if necessary"	Thermistor is out-of-range.	1.) Check wiring connections between thermistor and inverter board or 2.) Thermistor or 3.) Inverter board or 4.) 11 pin cable from inverter to main control connections
Flood Condition Stage 1	Screen will display "Attention! Shut off all water to this unit immediately. A problem has been detected with this unit" The washer sounds a warning signal and disables all user interfaces except signal pad on LCD. Drain pump will turn on when safety high limit is reached and turn off when tub is empty. Pump cycle will continue indefinitely or until filling stops.	Screen will display "Attention! Shut off all water to this unit immediately. A problem has been detected with this unit"	A flood condition has been detected by the inverter board.	1.) Water valve or 2.) Inverter board or 3.) Pressure sensor
Flood Condition Stage 2	No display. The unit goes into stand-by mode when the inverter is shut down.	Screen will display "There is a problem with this unit. The unit is filling with water valves turned off. Check inverter, pump and valves"	A flood condition has been detected by the main control board. The main board shuts down the inverter board.	1.) Water valve or 2.) Inverter board or 3.) Pressure sensor and Drain pump operation

PROBLEM	ERROR DISPLAYED FOR CUSTOMER	ERROR DISPLAYED IN SERVICE MODE	POSSIBLE CAUSE(S)	POSSIBLE REPAIR REQUIRED
Drain System	Screen will display "Notice This unit is not draining properly. Please check the drain hose for kinks or blockages" The washer will stop operation and a pad on the screen will allow the user to turn the drain pump on and off for testing.	Screen will display "The unit is not draining properly. Please check the drain system and pump"	Water remains in the tub after the drain pump has operated for 13 minutes (twice the drain time needed for an 8 ft. stand pipe)	1.) Drain hose obstruction or 2.) Drain pump or 3.) Repair wiring connections between inverter and drain pump or 4.) Inverter board
No Fill or Slow Fill	Screen will display "Notice This unit is not filling properly. Please check all water line connections for proper installation, ensure they are turned on and there are no blockages" Two pads on the screen will allow the user to check the hot and cold water valves. Pressing a pad will energize the appropriate valve for 10 seconds.	Screen will display "Water is not dispensing into unit properly. Check water line connections, water valves, detergent/bleach/additive dispensers and pressure sensor system"	Error is displayed for customer 7 minutes after cycle has started. Washer will continue trying to fill for an additional 33 minutes (40 minutes total) before <u>stopping operation</u> .	1.) Cycling the power may correct the problem or 2.) Water supply or 3.) Water valves or 4.) Pressure sensor or tubing
Pressure Sensor	Screen will display "Notice A problem has been detected with this unit" The washer will stop operation.	Screen will display "The pressure sensor or hose is damaged or disconnected. Please check and replace if necessary"	The signal from the pressure sensor is below the acceptable range (<20KHz)	1.) Pressure sensor hose or 2.) Pressure sensor and connections to inverter or 3.) Inverter board
Serial Washer and Dryer Connection	No error displayed. Unit will continue to operate normally.	Screen will display "Serial communication link between washer and dryer is down. Please check for proper connection, the dryer is plugged in, or board input/output signals"	The dryer sends a signal back to the washer acknowledging receipt of information. An error is set if the washer has not received a proper response from the dryer after 3 attempts.	1.) Check washer options to ensure communications feature is selected or 2.) Wiring connections or 3.) Serial cable or 4.) Internal washer or dryer cable or 5.) Main control board
Keypanel Membrane	No error displayed. Unit will continue to operate normally.	Screen will display "There is a problem with the membrane. Please check and replace if necessary"	Control sensed a keypanel membrane pad pressed for longer than 30 seconds.	1.) Wiring connections or 2.) Keypanel membrane

PROBLEM	ERROR DISPLAYED FOR CUSTOMER	ERROR DISPLAYED IN SERVICE MODE	POSSIBLE CAUSE(S)	POSSIBLE REPAIR REQUIRED
LCD Display Touchscreen	No error displayed. Unit will continue to operate normally.	Screen will display "There is a problem with the touchscreen. Please check and replace if necessary"	Control sensed an LCD display touchscreen input for longer than 30 seconds.	1.) Wiring connections or 2.) LCD display touchscreen
Lid Switch Stuck Closed	Screen will display "Please open the lid" and if opening is detected, the screen will display "Please close the lid" Operation will stop until the washer detects the lid has been opened.	Screen will display "There is a problem with the lid switches. Please check and replace if necessary"	An attempt has been made to start a cycle after 3 or more consecutive cycles without the washer detecting the lid has been opened.	1.) Wiring connections or 2.) Lid switch or 3.) Inverter board
Lid Switch Stuck Open	Screen will display "Please close the lid" Operation will stop until the washer detects the lid has been closed.	Screen will display "There is a problem with the lid switches. Please check and replace if necessary"	The washer did not detect the lid was closed within 5 minutes of displaying "Please close the lid"	1.) Wiring connections or 2.) Lid switch or 3.) Inverter board
Motor not rotating properly	Screen will display "Notice A problem has been detected with this unit" The washer will stop operation.	Screen will display "The motor is not rotating properly. Check and replace if necessary"	Low voltage at main plug or Hall sensor indicates the motor is not turning within 50% of the desired speed or Motor rotating in only one direction or Basket not reaching desired speed or Hall sensor indicates the motor is turning 20% faster than the desired speed	1.) House supply voltage or 2.) Wiring connections or 3.) Motor or 4.) Hall sensor or 5.) Inverter board
Clutch	Screen will display "Notice A problem has been detected with this unit" The washer will stop operation.	Screen will display "The clutch is not mechanically engaging with the basket properly"	The home position signal from the clutch motor has not been detected after three complete revolutions of the clutch motor.	1.) Wiring connections or 2.) Clutch motor or 3.) Inverter board

PROBLEM	ERROR DISPLAYED FOR CUSTOMER	ERROR DISPLAYED IN SERVICE MODE	POSSIBLE CAUSE(S)	POSSIBLE REPAIR REQUIRED
Basket doesn't brake fast enough	Screen will display " Notice A problem has been detected with this unit " The washer will stop operation.	Screen will display " The basket is not slowing down properly. Check the brake resistor and motor for proper operation "	After applying the brake, the basket failed to stop within 10 seconds more than 3 times over the life of the washer or A broken clutch assembly	1.) Motor or 2.) Brake resistor or 3.) Inverter board or 4.) Clutch assembly
Inverter not operating correctly	No error displayed. Unit will continue to operate normally.	Screen will display " The inverter PCB has a history of not running properly "	The inverter board is operating 7 degrees over the maximum temperature rating. If the temperature falls back below the max temperature limit by more than 5 degrees, the unit will return to normal and clear error. Service mode must be exited and setup mode completed to clear error.	1.) Inverter board
Brake Resistor failed	No error displayed. The washer will stop operation and shut off.	Screen will display " There is a problem with the brake resistor "	The voltage across the brake resistor is outside the acceptable range.	1.) Brake resistor or 2.) Inverter board
Main / Inverter Comm Error	No error displayed. Unit will continue to operate normally.	Screen will display " There is a problem with communications between the main and inverter boards "	If the inverter board fails to respond to the main board or the main board fails to respond to the inverter board within 2 seconds.	1.) Wiring connections or 2.) Inverter board or 3.) Main control board
Broken Clutch Coupling	Screen will display " Notice A problem has been detected with this unit " The washer will stop operation.	Screen will display " The clutch coupler appears to be damaged or broken "	The basket was detected as slowing down too quickly while braking from a spin. The stopping time depends on what speed the basket was turning when the error was detected.	1.) Clutch assembly

Schematic

COLOR CODE			
LETTERS	COLOR	LETTERS	COLOR
AX	LT. BLUE	RX	RED
BX	BLACK	SX	GRAY
CX	BROWN	GX	GREEN
NX	DK.BLUE	VX	PURPLE
OX	ORANGE	WX	WHITE
PX	PINK	YX	YELLOW

THE "X" INDICATES ONE SOLID COLOR - NO TRACER. WIRES WITH TRACER SHOW BOTH COLORS, EXAMBLE - WR IS WHITE WITH RED TRACER.

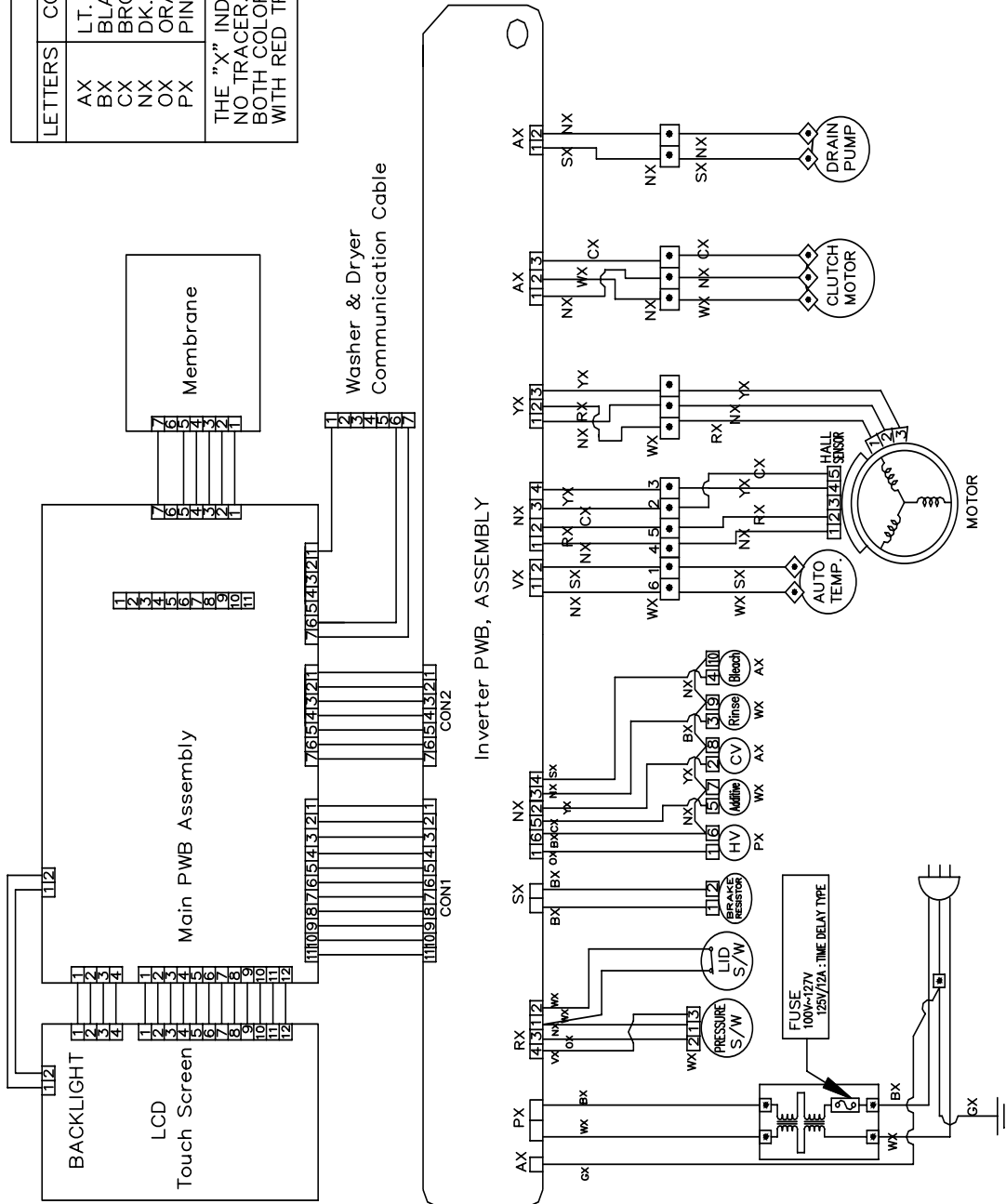

PARTS

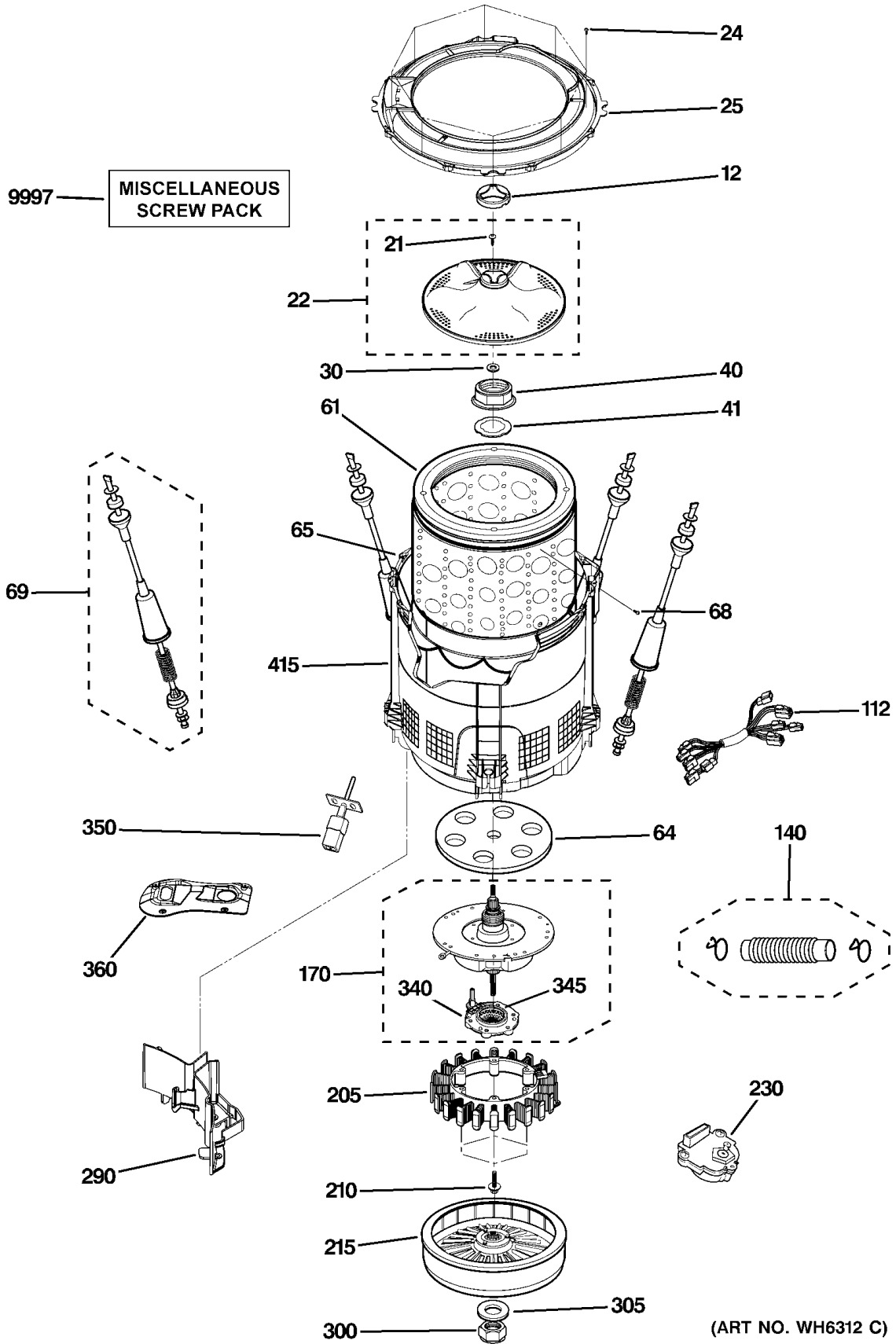

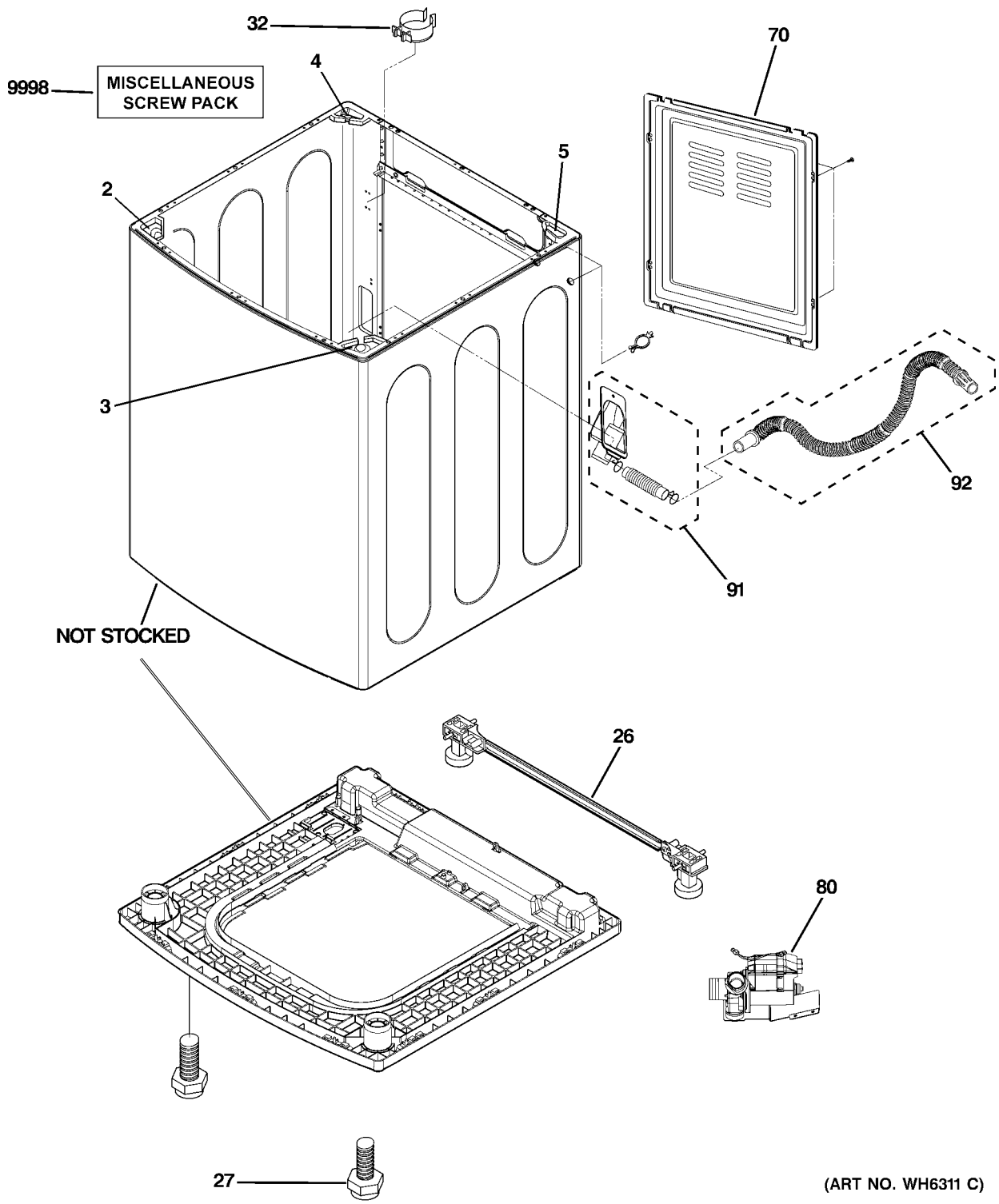

9996 MISCELLANEOUS SCREW PACK

10 SELECT R.H. OR L.H. PANEL AS REQUIRED (SEE PARTS LIST)

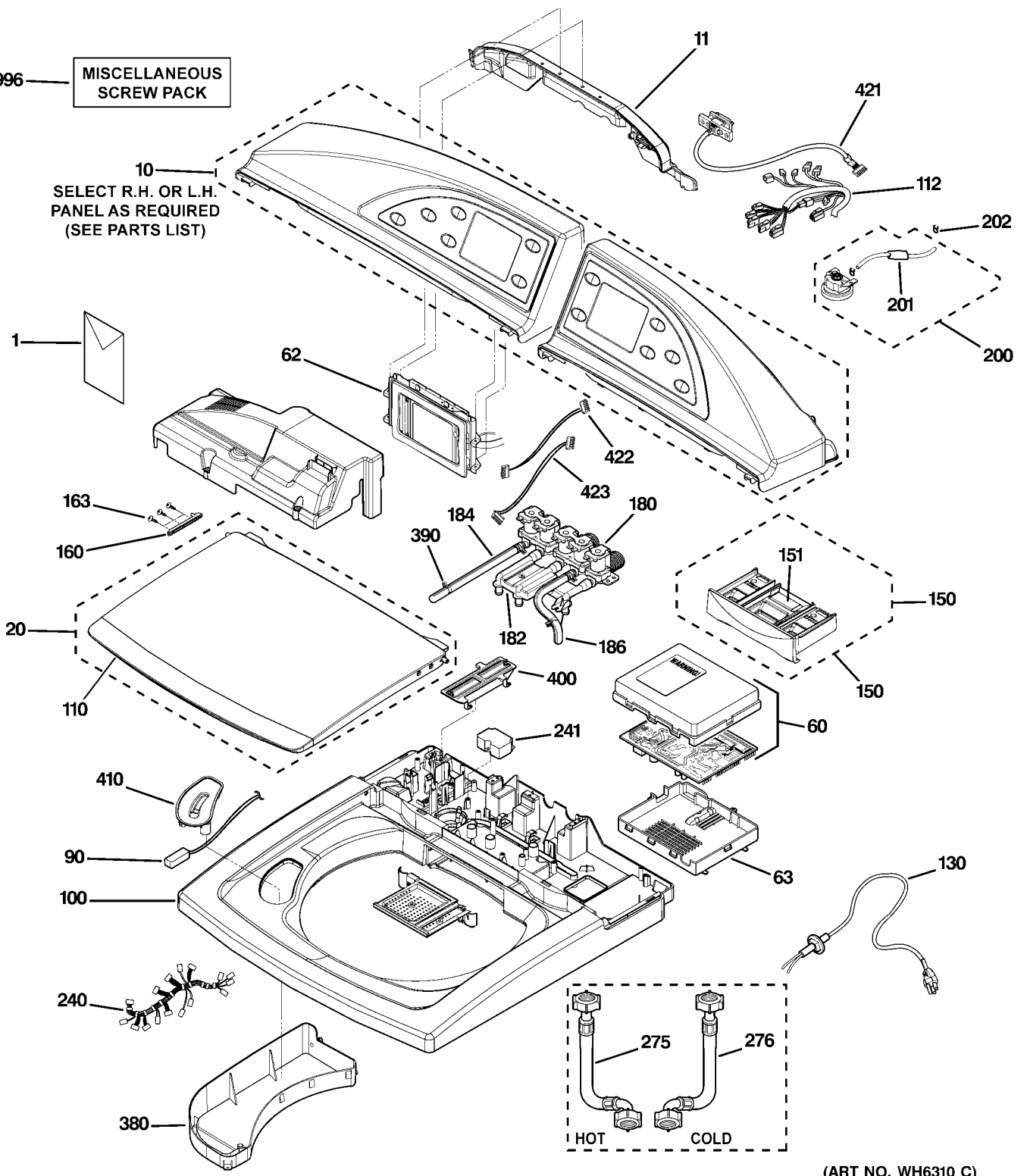

(ART NO. WH6310 C)

VIEW NUMBER	CATALOG NUMBER	DESCRIPTION	QUANTITY
1	4830151	MANUAL, USE & CARE	1
1	31-15543	MANUAL, MIN	1
2	WHISX10052	HANGER ASM, PIVOT	1
3	WHISX10053	HANGER ASM, PIVOT	1
4	WHISX10054	HANGER ASM, PIVOT	1
5	WHISX10055	HANGER ASM, PIVOT	1
10	WHASX10038	PANEL ASM, FRONT/WHLH	1
10	WIE1X10072	CONTROL PANEL ASM WHRRH	1
11	WHASX10037	PANEL, BACK	1
12	WH3X10026	GAP, PULSATOR	1
20	WH4X10116	LID ASM WH	1
21	WH02X10151	P.F SCREW ASM	1
22	WH3X10027	PULSATOR ASM	1
24	WH02X10143	SCREW TAPPING, TRUSS HD	8
25	WH4X10117	COVER ASSEMBLY, TUB	1
26	WH02X10144	LEG ASM - REAR	2
27	WH02X10145	LEG ASM W/CLIP	12
30	WH02X10152	WASHER	1
32	WH01X10304	CLAMP	2
40	WH01X10305	NUT	1
41	WH02X10146	WASHER	1
60	WH12X10345	PWB/PCB ASM - MAIN	1
61	WHASX10054	BALANCE ASM	1
62	WH12X10346	DISPLAY ASM - PWB/PCB	1
63	WHASX10039	COVER, PROTECT	1
64	WHASX10053	HUB, INNER TUB	1
65	WHASX10056	TUB ASM - INNER	1
68	WH02X10147	SCREW	8
69	WHISX10056	SUSPENSION ASM	4
70	WHASX10101	BACK COVER	1
90	WH23X10020	PUMP ASM - DRAIN	1
90	WH12X10344	LID SWITCH ASM	1
91	WH41X10081	CONNECTOR - HOSE ASM	1
92	WH41X10082	DRAIN HOSE ASM	1
100	WH4X10118	TOP COVER WH	1
110	WH01X10306	LID TRIM	1
112	WH13X10027	HARNESS, PWB	1
130	WH13X10028	POWER CORD ASM	1
140	WH41X10083	DRAIN HOSE	1

VIEW NUMBER	CATALOG NUMBER	DESCRIPTION	QUANTITY
150	WH47X10004	DETERGENT BOX ASM	1
151	WH47X10005	INSERT, DETERGENT BOX	1
160	WH02X10207	HINGE	2
163	WH02X10143	SCREW	6
170	WH52X10003	MECH H8NG ASM - BEARING	1
180	WH13X10017	VALVE ASM - INLET	1
182	WH42X10034	PIPE	1
184	WH42X10035	HOSE, INLET	1
186	WH42X10036	HOSE, INLET	1
200	WH12X10247	SENSOR SWITCH ASM	1
201	WH42X10037	TUBE, PRESSURE SW	1
202	WH02X10208	RING, SNAP	1
205	WH52X10004	STATOR ASM	1
210	WH02X10140	BOLT	6
215	WH52X10005	ROTOR ASM	1
230	WH20X10024	MOTOR ASM W/CLUTCH	1
240	WH19X10029	HARNES, PWS	1
241	WH12X10243	FILTER ASM -CIRC	1
275	WH42X10033	HOSE, INLET	1
276	WH42X10039	HOSE, INLET	1
290	WH42X10030	GUIDE, WATER	1
300	WH02X10209	NUT	1
305	WH02X10150	WASHER	1
340	WH02X10210	COUPLING ASM	1
305	WH02X10150	WASHER	1
345	WH02X10211	COUPLING	1
350	WH12X10240	THERMISTOR ASM	1
360	WH44X10119	COVER, PROTECT	1
380	WH47X10007	BOX, BLEACH	1
390	WH02X10212	CLAMP	4
360	WH44X10119	COVER, PROTECT	1
400	WH12X10250	RESISTOR	1
410	WH02X10213	BLEACH CAP	1
415	WH45X10057	TUB - OUTER	1
421	WE03X10061	CABLE ASSEMBLY	1
422	WH19X10031	CONNECTOR ASM	1
423	WH19X10030	CONNECTOR ASM	1
9206	WH02X10153	SCREW PACK	1
9207	WH02X10150	SCREW PACK	1
422	WE03X10053	CONNECTOR ASM	1
9208	WH02X10160	SCREW PACK	1

Switching the Washer and Dryer Backsplashes

Overview

When viewed from the front, the washer is shipped for installation on the left and the dryer is shipped for installation on the right. If the hose utility connections are arranged so that the units must be installed with the washer on the right and the dryer on the left, the backsplashes of the washer and dryer can be switched in order to maintain the proper curved appearance.

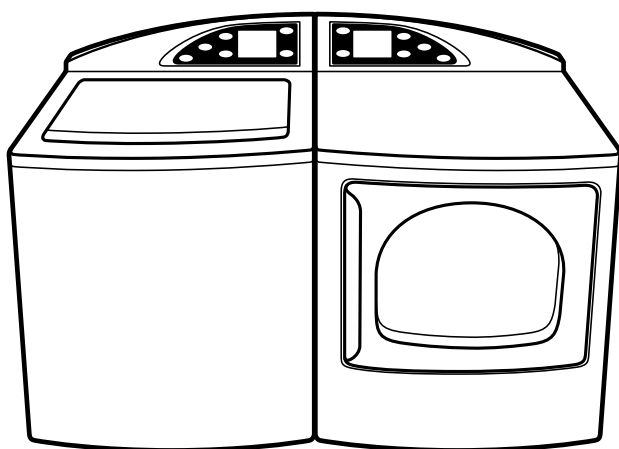

To switch the washer and dryer backsplashes:

1. Place a towel over the lid of the washer to prevent scratches to the surface.
2. Remove the 2 Phillips head screws from the washer backsplash.
3. Rotate backsplash forward and lift off.

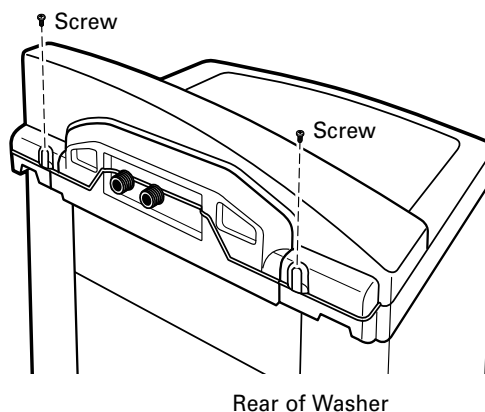

4. Remove the 2 Phillips head screws holding the backsplash to the rear cover. Remove the backsplash from the rear cover.

Tools Needed

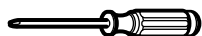

#2 Screwdriver

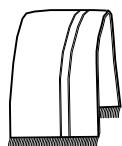

Towel (2)

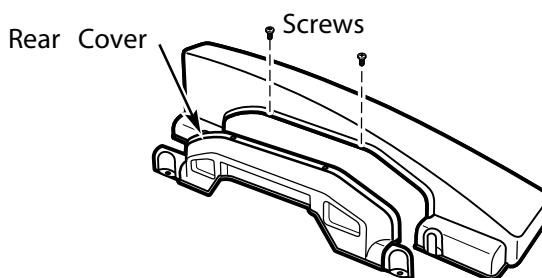

WARNING!

- Make sure the washer and dryer are unplugged.
- Turn both the home hot and cold-water valves to the off position.
- Turn the home gas shut-off valve to the Off position (for gas dryer models).

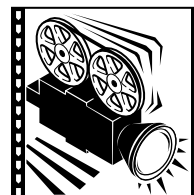

Control Panel Reversal

- Disconnect the ribbon at the right of the washer control board by pulling the connector at the end of the ribbon off the metal pins.

Note: Do not disconnect any other wires from the washer control board.

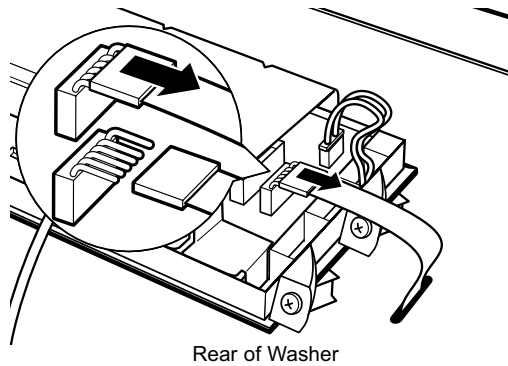

- Remove the 4 Phillips head screws holding the washer control board to the backslash then remove the control board and set it aside.

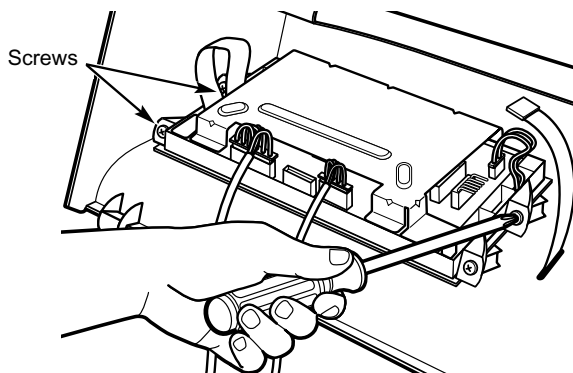

- Place a towel over the top surface of the dryer to prevent scratches to the surface.

- Remove the 4 Phillips head screws from the dryer backslash. Rotate backslash forward and lift off.

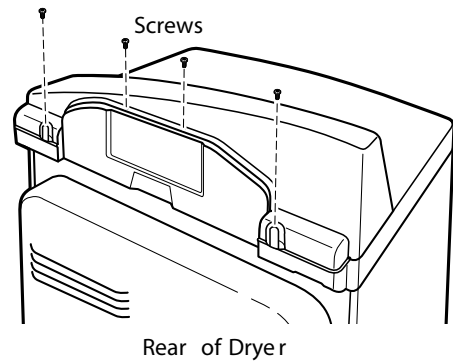

- Disconnect the ribbon at the right of the dryer control board by pulling the connector at the end of the ribbon off the metal pins.

Note: Do not disconnect any other wires from the dryer control board.

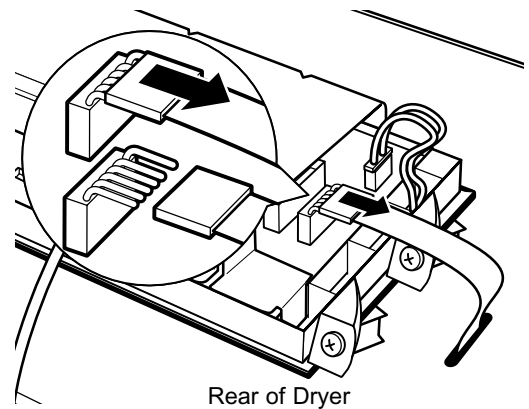

- Remove the 4 Phillips head screws holding the dryer control board to the backslash.

- Remove the dryer control board and set it aside.

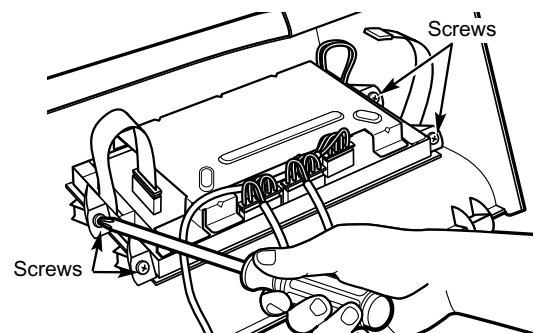

(Continued Next Page)

12. Place the backsplash from the dryer on top of the washer and place the backsplash from the washer on top of the dryer.

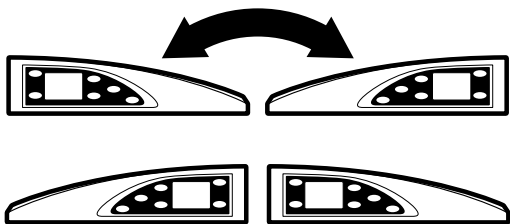

15. Place the gray wire from the serial port under the strain relief of the new backsplash.

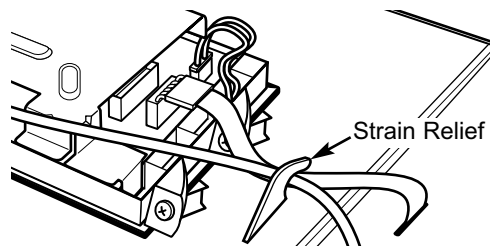

13. Attach the dryer control board to the new backsplash by replacing the 4 Phillips head screws removed from the dryer control board earlier.

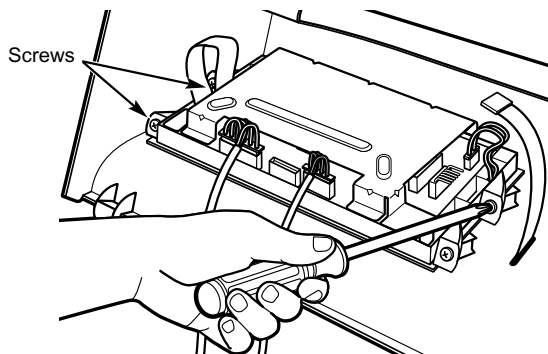

16. Insert the tabs on the bottom front of the new backsplash into the slots on the dryer and rotate the backsplash into place.

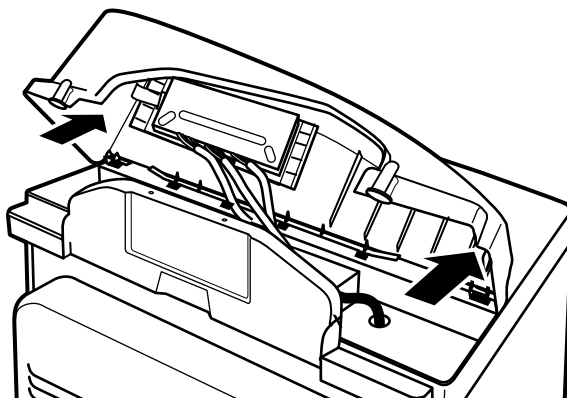

14. Connect the dryer control board to the new backsplash by sliding the ribbon connector on the new backsplash onto the metal pins on the control board and pushing in. Make sure the ribbon is not twisted before inserting the connector.

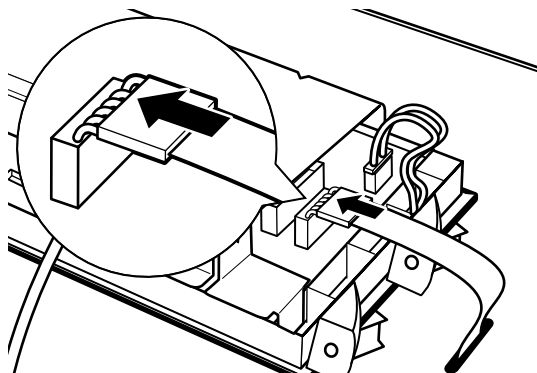

17. Secure the new backsplash to the dryer using the 4 Phillips head screws removed earlier.

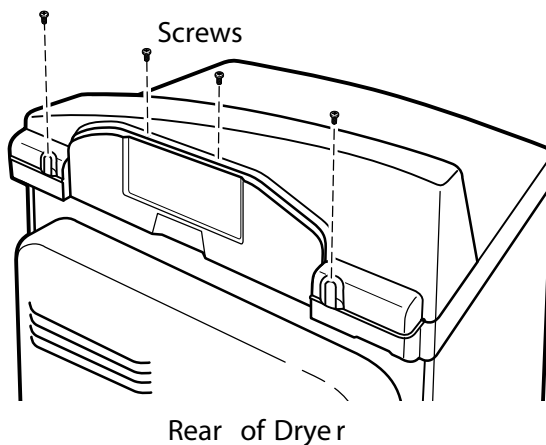

18. Attach the washer control board to the new backsplash by replacing the 4 Phillips head screws removed from the washer control board earlier.

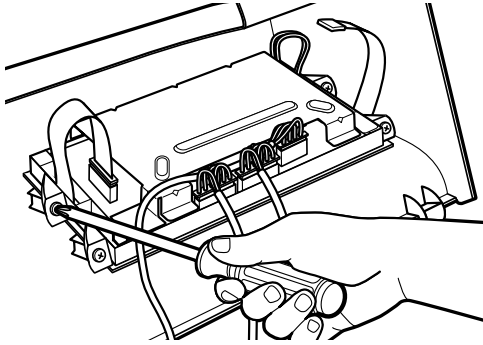

21. Place the gray wire from the serial port under the strain relief of the new backsplash.

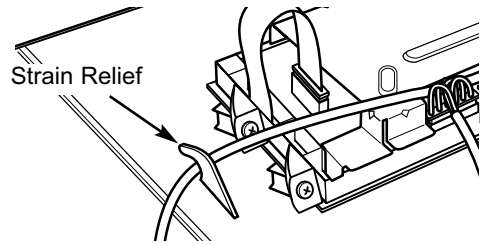

19. Connect the washer control board to the new backsplash by sliding the ribbon connector on the new backsplash onto the metal pins on the control board and pushing in. Make sure the ribbon is not twisted before inserting the connector.

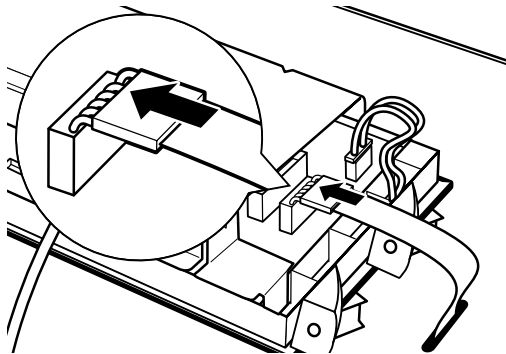

22. Insert the tabs on the bottom front of the new backsplash into the slots on the washer and rotate the backsplash into place.

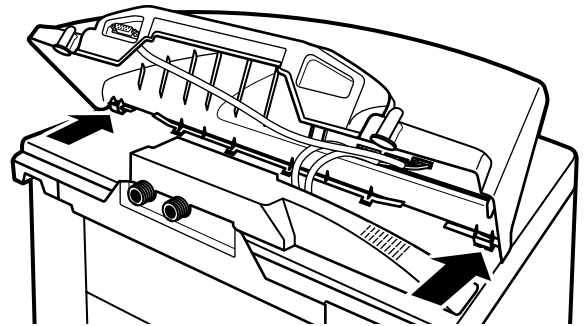

20. Secure the new washer backsplash to the rear cover using the 2 Phillips head screws removed earlier.

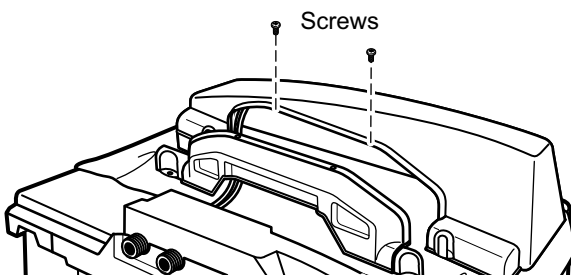

23. Secure the new backsplash to the washer using the 2 Phillips head screws removed earlier.

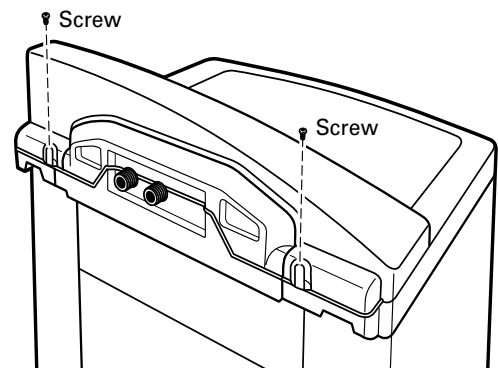

Rear of Washer

24. Reconnect house utilities.

25. Plug the washer and dryer back in.

TEMPERATURE CONVERSION TABLE

°C	°F	°C	°F	°C	°F	°C	°F	°C	°F	°C	°F	°C	°F
-40	-40	-10	14	20	68	50	122	80	176	110	230	140	284
-39	-38.2	-9	15.8	21	69.8	51	123.8	81	177.8	111	231.8	141	285.8
-38	-36.4	-8	17.6	22	71.6	52	125.6	82	179.6	112	233.6	142	287.6
-37	-34.6	-7	19.4	23	73.4	53	127.4	83	181.4	113	235.4	143	289.4
-36	-32.8	-6	21.2	24	75.2	54	129.2	84	183.2	114	237.2	144	291.2
-35	-31	-5	23	25	77	55	131	85	185	115	239	145	293
-34	29.2	-4	24.8	26	78.8	56	132.8	86	186.8	116	240.8	146	294.8
-33	-27.4	-3	26.6	27	80.6	57	134.6	87	188.6	117	242.6	147	296.6
-32	-25.6	-2	28.4	28	82.4	58	136.4	88	190.4	118	244.4	148	298.4
-31	-23.8	-1	30.2	29	84.2	59	138.2	89	192.2	119	246.2	149	300.2
-30	-22	0	32	30	86	60	140	90	194	120	248	150	302
-29	-20.2	1	33.8	31	87.8	61	141.8	91	195.8	121	249.8	151	303.8
-28	-18.4	2	35.6	32	89.6	62	143.6	92	197.6	122	251.6	152	305.6
-27	-16.6	3	37.4	33	91.4	63	145.4	93	199.4	123	253.4	153	307.4
-26	-14.8	4	39.2	34	93.2	64	147.2	94	201.2	124	255.2	154	309.2
-25	-13	5	41	35	95	65	149	95	203	125	257	155	311
-24	-11.2	6	42.8	36	96.8	66	150.8	96	204.8	126	258.8	156	312.8
-23	-9.4	7	44.6	37	98.6	67	152.6	97	206.6	127	260.6	157	314.6
-22	-7.6	8	46.4	38	100.4	68	154.4	98	208.4	128	262.4	158	316.4
-21	-5.8	9	48.2	39	102.2	69	156.2	99	210.2	129	264.2	159	318.2
-20	-4	10	50	40	104	70	158	100	212	130	266	160	320
-19	-2.2	11	51.8	41	105.8	71	159.8	101	213.8	131	267.8	161	321.8
-18	-0.4	12	53.6	42	107.6	72	161.6	102	215.6	132	269.6	162	323.6
-17	1.4	13	55.4	43	109.4	73	163.4	103	217.4	133	271.4	163	325.4
-16	3.2	14	57.2	44	111.2	74	165.2	104	219.2	134	273.2	164	327.2
-15	5	15	59	45	113	75	167	105	221	135	275	165	329
-14	6.8	16	60.8	46	114.8	76	168.8	106	222.8	136	276.8	166	330.8
-13	8.6	17	62.6	47	116.6	77	170.6	107	224.6	137	278.6	167	332.6
-12	10.4	18	64.4	48	118.4	78	172.4	108	226.4	138	280.4	168	334.4
-11	12.2	19	66.2	49	120.2	79	174.2	109	228.2	139	282.2	169	336.2

