

**CSA8200 Communications Signal Analyzer  
TDS8200 Digital Sampling Oscilloscope  
Quick Start User Manual**

Copyright © Tektronix, Inc. All rights reserved. Licensed software products are owned by Tektronix or its suppliers and are protected by United States copyright laws and international treaty provisions.

Use, duplication, or disclosure by the Government is subject to restrictions as set forth in subparagraph (c)(1)(ii) of the Rights in Technical Data and Computer Software clause at DFARS 252.227-7013, or subparagraphs (c)(1) and (2) of the Commercial Computer Software - Restricted Rights clause at FAR 52.227-19, as applicable.

Tektronix products are covered by U.S. and foreign patents, issued and pending. Information in this publication supercedes that in all previously published material. Specifications and price change privileges reserved.

TEKTRONIX and TEK are registered trademarks of Tektronix, Inc.

## **Contacting Tektronix**

Tektronix, Inc.  
14200 SW Karl Braun Drive or P.O. Box 500  
Beaverton, OR 97077 USA

For product information, sales, service, and technical support:

- In North America, call 1-800-833-9200.
- Worldwide, visit [www.tektronix.com](http://www.tektronix.com) to find contacts in your area.

## Warranty 2

Tektronix warrants that this product will be free from defects in materials and workmanship for a period of one (1) year from the date of shipment. If any such product proves defective during this warranty period, Tektronix, at its option, either will repair the defective product without charge for parts and labor, or will provide a replacement in exchange for the defective product. Parts, modules and replacement products used by Tektronix for warranty work may be new or reconditioned to like new performance. All replaced parts, modules and products become the property of Tektronix.

In order to obtain service under this warranty, Customer must notify Tektronix of the defect before the expiration of the warranty period and make suitable arrangements for the performance of service. Customer shall be responsible for packaging and shipping the defective product to the service center designated by Tektronix, with shipping charges prepaid. Tektronix shall pay for the return of the product to Customer if the shipment is to a location within the country in which the Tektronix service center is located. Customer shall be responsible for paying all shipping charges, duties, taxes, and any other charges for products returned to any other locations.

This warranty shall not apply to any defect, failure or damage caused by improper use or improper or inadequate maintenance and care. Tektronix shall not be obligated to furnish service under this warranty a) to repair damage resulting from attempts by personnel other than Tektronix representatives to install, repair or service the product; b) to repair damage resulting from improper use or connection to incompatible equipment; c) to repair any damage or malfunction caused by the use of non-Tektronix supplies; or d) to service a product that has been modified or integrated with other products when the effect of such modification or integration increases the time or difficulty of servicing the product.

THIS WARRANTY IS GIVEN BY TEKTRONIX WITH RESPECT TO THE PRODUCT IN LIEU OF ANY OTHER WARRANTIES, EXPRESS OR IMPLIED. TEKTRONIX AND ITS VENDORS DISCLAIM ANY IMPLIED WARRANTIES OF MERCHANTABILITY OR FITNESS FOR A PARTICULAR PURPOSE. TEKTRONIX' RESPONSIBILITY TO REPAIR OR REPLACE DEFECTIVE PRODUCTS IS THE SOLE AND EXCLUSIVE REMEDY PROVIDED TO THE CUSTOMER FOR BREACH OF THIS WARRANTY. TEKTRONIX AND ITS VENDORS WILL NOT BE LIABLE FOR ANY INDIRECT, SPECIAL, INCIDENTAL, OR CONSEQUENTIAL DAMAGES IRRESPECTIVE OF WHETHER TEKTRONIX OR THE VENDOR HAS ADVANCE NOTICE OF THE POSSIBILITY OF SUCH DAMAGES.



# Table of Contents

General Safety Summary .....	iii
Preface .....	v
Documentation .....	v
Conventions Used in this Manual .....	vi
Key Features .....	1
Install Your Instrument .....	3
Standard Accessories .....	3
Operating Requirements .....	4
Environmental .....	4
Power Supply Requirements .....	4
Installing Modules .....	5
Powering the Instrument On and Off .....	6
Creating an Emergency Startup Disk .....	7
Adding a Second Monitor .....	8
Changing the Windows Language .....	10
Getting Acquainted with Your Instrument .....	12
Front Panel .....	12
Rear Panel .....	12
Interface .....	13
Control Panel .....	14
Display - Single Graticule View .....	15
Display - Multiple Views .....	15
Accessing Online Help .....	16
Inspect Your Instrument .....	18
Verify Internal Diagnostics Pass .....	18
Optimizing Measurement Accuracy .....	20
Signal Path Compensation .....	20
Perform Dark-Level and User Wavelength Gain Compensations .....	22
Acquisition .....	24
Setting Up Signal Input .....	24
Using Autoset .....	26
Using Default Setup .....	26
Accessing the Setup Dialog Boxes .....	27
Changing the Acquisition Mode .....	28
Setting the Display Style .....	29
Triggers .....	30
Triggering Concepts .....	30
Trigger Event .....	30
Trigger Type .....	30
Trigger Modes .....	30
Trigger Sources .....	30
Trigger Source Connectors .....	31
Gated Trigger Connector (Option GT Equipped) .....	32
Enhanced Triggering .....	32
Trigger Holdoff .....	32
Setting Trigger Controls .....	34
Setting Pattern Sync Controls .....	35
Checking Trigger Status .....	36
Analyzing Waveforms .....	37
Taking Automatic Measurements .....	37

Turning Off Automatic Measurements . . . . .	41
Cursor Measurements . . . . .	42
Math Waveforms . . . . .	44
Waveform Databases . . . . .	46
Display a Communication Signal . . . . .	47
Display and Analyze Communication Signals Using Mask Testing . . . . .	48
FrameScanR . . . . .	51
To Use TDR . . . . .	52
Phase Reference . . . . .	53
Histograms . . . . .	54
Document Your Results . . . . .	55
Using the 80A05 Electrical Clock Recovery Module Examples . . . . .	56
Clock Recovery / Trigger on Recovered Clock . . . . .	57
Clock Recovery / Trigger for Optical Signal, with the 80C12 Optical Module . . . . .	58
Differential Clock Recovery and Acquisition . . . . .	59
Probing with Low-impedance Probes . . . . .	60
Probing with Differential to Single-ended Probes . . . . .	61
Vertical Gain Adjustment . . . . .	62
Skew and Deskewing . . . . .	63
Minimizing Skew . . . . .	63
Measuring Skew . . . . .	64
Methods to Deskew Your Signals . . . . .	64
Methods to Adjust Out Skew . . . . .	66
Cleaning the Instrument . . . . .	67
Exterior Cleaning . . . . .	67
Flat Panel Display Cleaning . . . . .	67
Optical Connector Cleaning . . . . .	67
Index . . . . .	69

# General Safety Summary

Review the following safety precautions to avoid injury and prevent damage to this product or any products connected to it. To avoid potential hazards, use this product only as specified.

*Only qualified personnel should perform service procedures.*

While using this product, you may need to access other parts of the system. Read the *General Safety Summary* in other system manuals for warnings and cautions related to operating the system.

## To Avoid Fire or Personal Injury

**Use Proper Power Cord.** Use only the power cord specified for this product and certified for the country of use.

**Connect and Disconnect Properly.** Do not connect or disconnect probes or test leads while they are connected to a voltage source.

**Ground the Product.** This product is grounded through the grounding conductor of the power cord. To avoid electric shock, the grounding conductor must be connected to earth ground. Before making connections to the input or output terminals of the product, ensure that the product is properly grounded.

**Observe All Terminal Ratings.** To avoid fire or shock hazard, observe all ratings and markings on the product. Consult the product manual for further ratings information before making connections to the product.

Do not apply a potential to any terminal, including the common terminal, that exceeds the maximum rating of that terminal.

**Do Not Operate Without Covers.** Do not operate this product with covers or panels removed.

**Use Proper Fuse.** Use only the fuse type and rating specified for this product.

**Avoid Exposed Circuitry.** Do not touch exposed connections and components when power is present.

**Wear Eye Protection.** Wear eye protection if exposure to high-intensity rays or laser radiation exists.

**Do Not Operate With Suspected Failures.** If you suspect there is damage to this product, have it inspected by qualified service personnel.

**Do Not Operate in Wet/Damp Conditions.**

**Do Not Operate in an Explosive Atmosphere.**

**Keep Product Surfaces Clean and Dry.**

**Provide Proper Ventilation.** Refer to the manual's installation instructions for details on installing the product so it has proper ventilation.

## Symbols and Terms

**Terms in this Manual.** These terms may appear in this manual:



---

**WARNING.** Warning statements identify conditions or practices that could result in injury or loss of life.

---



**CAUTION.** Caution statements identify conditions or practices that could result in damage to this product or other property.

---

**Terms on the Product.** These terms may appear on the product:

DANGER indicates an injury hazard immediately accessible as you read the marking.

WARNING indicates an injury hazard not immediately accessible as you read the marking.

CAUTION indicates a hazard to property including the product.

**Symbols on the Product.** The following symbols may appear on the product:



CAUTION  
Refer to Manual



WARNING  
High Voltage



Protective Ground  
(Earth) Terminal



Mains Disconnected  
OFF (Power)



Mains Connected  
ON (Power)



Standby



# Preface

## Documentation

This manual describes the installation and operation of CSA8200 & TDS8200 Series Instruments along with basic operations and concept. For more detailed information, see the online help on your instrument.

**NOTE.** The screen images in this manual are based on product software version 2.4 and may differ slightly from other versions of product software.

Additional information is available through a variety of sources. The following information map points to the location of different types of information available for this product.

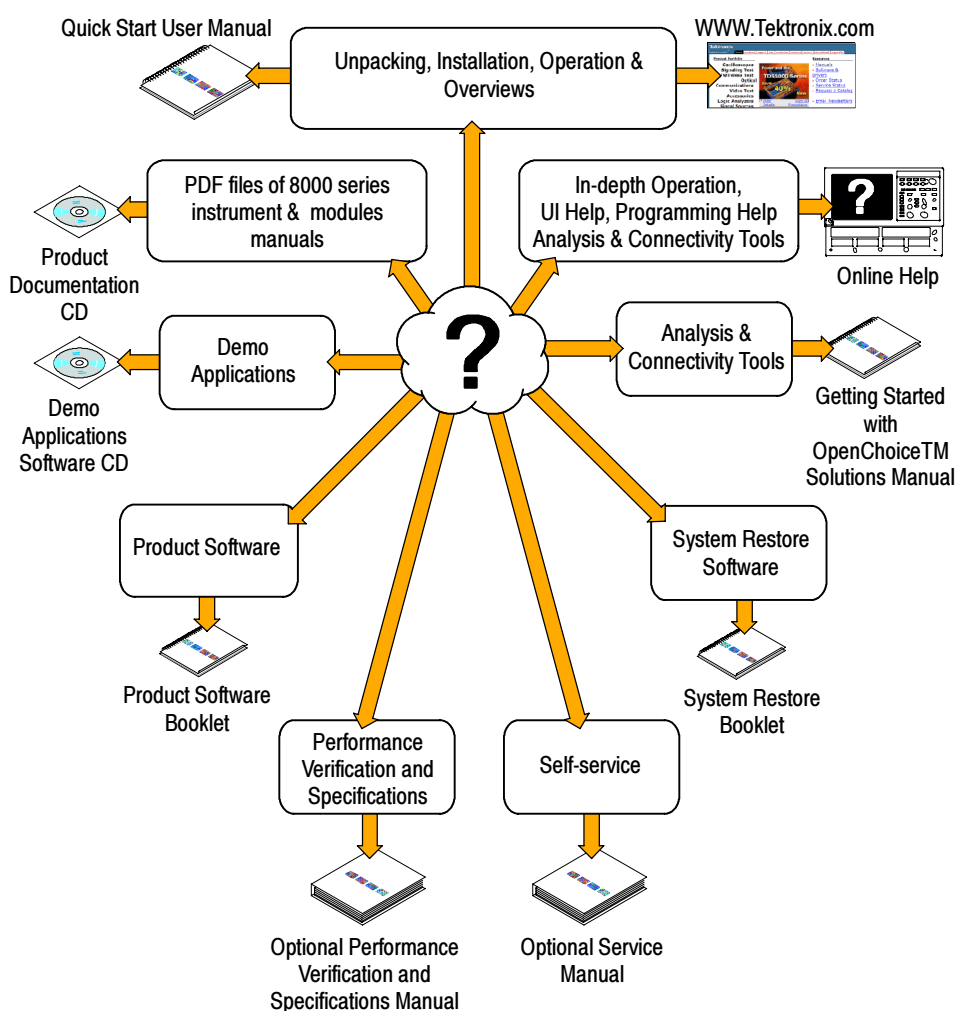

## Conventions Used in this Manual

The following icons are used throughout this manual.

Rear panel  
power

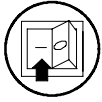

Front panel  
power



Connect pow-  
er

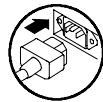

Network

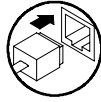

PS2

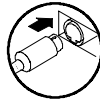

SVGA

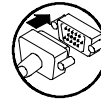

USB

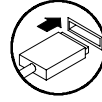

## Key Features

The CSA8200 and TDS8200 Series instruments are high-speed, precision sampling systems that find use in validation and conformance testing and impedance verification for:

- High-performance semiconductor/computer applications, such as semiconductor testing, TDR characterization of circuit boards, IC packages and cables, and high-speed serial digital data communications.
- High-performance communications applications, such as design evaluation and manufacturing test of datacom and telecom components, transceiver subassemblies, and transmission systems.

The instruments include a user interface that runs on the Microsoft Windows 2000 operating system as a windowed application. You operate the instrument using front-panel controls with the mouse and keyboard or with the touch screen.

Features Include:

- Industry-leading waveform acquisition and measurement rate, with Sample, Envelope, and Average acquisition modes.
- Support for up to six sampling modules (two large and four small modules). Up to eight inputs can be active at a time.
- Supports integrated optical and/or electrical signal pick-off and clock recovery, enabling accurate triggering on optical and/or electrical communication-signals.
- Support for optical modules with several integrated, selectable reference receivers, which eliminates the need for a multitude of add-on reference receivers.
- Full programmability, with an extensive GPIB-command set and a message-based interface.
- True differential TDR, with fast step (35 psec reflected risetime) when used with a TDR-capable sampling module.
- Industry-leading trigger bandwidth (12+ GHz) when using the built-in-prescaler.
- Support of both telecom (SONET and SDH) and datacom (Fibre Channel, Infiniband, and Gigabit Ethernet) optical communication standards.
- Powerful built-in measurement capability, including histograms, mask testing, and automatic measurements.
- Automatic measurements operate on Pulses, RZ eye patterns, and NRZ eye patterns.
- DC to 65 GHz optical bandwidth; DC to 70+ GHz electrical bandwidth, with up to 12.5 GHz triggering.

---

**NOTE.** Bandwidth is determined by the specific modules that are installed.

---

- Low jitter (200 fs typical) in phase reference modes with the 82A04 Phase Reference module.
- FrameScan acquisition for isolating data-dependent failures during conformance/performance testing and for examining very low-level repetitive signals.
- Jitter analysis with the 80SJNB Advanced Jitter, Noise and BER Analysis Software for the TDS/CSA8000 Series Sampling Oscilloscopes application (requires software key). Refer to the *8000 Series Product Software* CDROM booklet for free trial information and software key use.
- Pattern (frame) triggering with the 80A06 PatternSync Trigger module.

- Improved acquisition throughput and timing accuracy using the PatternSync Trigger module in conjunction with FrameScan.
- Support for optical conformance testing of SONET/SDH signals (including the various forward error correction rates for these telecom rates) from 155 Mbps to 43 Gb/s, FibreChannel signals, and 1, 2, and 10 Gigabit Ethernet signals as well as 2.5 Gb/s Infiniband signals.

---

**NOTE.** Support for conformance testing rates is determined by the specific modules that are installed.

---

- High precision time base with two modes of operation, locked and short-term jitter-optimized.
- Negligible long-term jitter degradation (<0.1 ppm), which substantially improves the ability to view signals that are delayed far from the trigger point without distortion.
- Improved short-term and long-term trigger jitter.
- A gated trigger option (Option GT) that lets you disable or enable (gate) triggering based on a TTL signal you connect to the instrument rear panel. This Option allows you to use recirculating buffers as part of your test setup to simulate the effects of very long optical links that are typical of undersea cables and long terrestrial links.
- Analysis and connectivity tools enable the instrument to be controlled from a variety of local and remote environments and to share data with other commercially available analysis programs.
- Predefined, built-in masks in addition to the user-defined masks.
- A large 10-inch color display that supports color grading of waveform data to show sample density.
- An intuitive UI (User Interface), with built-in online help displayable on screen.

## Install Your Instrument

Unpack the instrument and check that you received all items listed as Standard Accessories. Recommended accessories and probes, instrument options, and upgrades are listed in the online help. Check the Tektronix Web site ([www.tektronix.com](http://www.tektronix.com)) for the most current information.

### Standard Accessories

Accessory	Tektronix part number
CSA8200 Communications Signal Analyzer TDS8200 Digital Sampling Oscilloscope Quick Start User Manual	071-1482-xx
Certificate of Traceable Calibration for product at initial shipment	Not orderable
Business reply card	Not orderable
1 Windows compatible keyboard	119-B146-00
1 Windows compatible mouse	119-6936-00
1 Instrument front cover	200-4519-00
1 Accessory pouch	016-1441-00
2 Touchscreen styluses	119-6107-00
1 ESD wrist strap with 6 foot coiled cord	006-3415-04
CSA8000 & TDS8000 Series Product Documentation Kit (CD)	020-2543-xx
CSA8000 & TDS8000 Online Help (part of application software)	Not orderable
CSA8000 & TDS8000 Programmer Online Guide (part of application software)	Not orderable
Oscilloscope Analysis and Connectivity Made Easy (manual and CD with connectivity examples)	020-2449-xx
CSA8000 & TDS8000 Series Windows 2000 OS Restore Kit	020-2527-xx
CSA8000 & TDS8000 Series Product Software Kit	020-2526-xx
8000 Series Demo Applications Software CD	020-2480-xx
1 Power cord	Type dependent on selection during order placement

## Operating Requirements

### Environmental

1. Place the instrument on a cart or bench, observing clearance requirements:
  - Top, Front, and Rear: 0 in (0 mm)
  - Sides: 2 in (51 mm)
  - Bottom: 0.75 in (19 mm)
2. Before operating, ensure that the ambient temperature is between +50 °F to +104 °F (+10 °C to +40 °C).

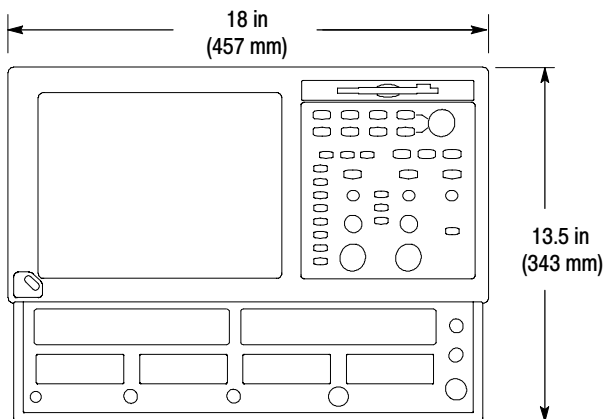

**CAUTION.** To ensure proper cooling, keep the bottom and sides of the instrument clear of obstructions.

### Power Supply Requirements

Source voltage and Frequency

100 - 240 V<sub>RMS</sub> ±10%, 50 - 60 Hz or 115 V<sub>RMS</sub> ±10%, 400 Hz

Power Consumption

240 watts (fully loaded); 160 watts (mainframe alone with no modules)

## Installing Modules



**CAUTION.** Never install or remove modules while the instrument is powered on.

Use an ESD wrist strap when installing or removing modules and when connecting signals to the module inputs.

Do not transport or ship the instrument with modules installed.

1. Always use an ESD wrist strap (provided) when installing and removing modules.
2. You can install up to two large sampling modules and four small modules for a total of 8 inputs.

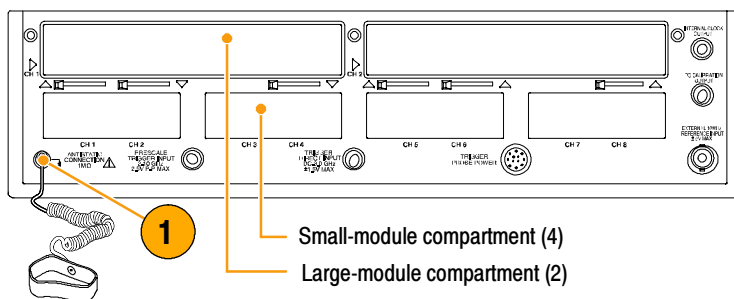

Following are some typical module installations illustrating the interaction between large compartment channels and small compartment channels.

**NOTE.** A large compartment module that only derives power from the compartment does not use any small compartment input channels.

Eight channels: No large and four small modules

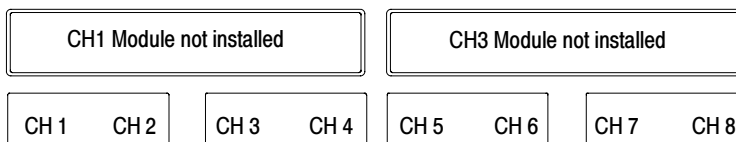

Six channels: Two large modules and two small modules

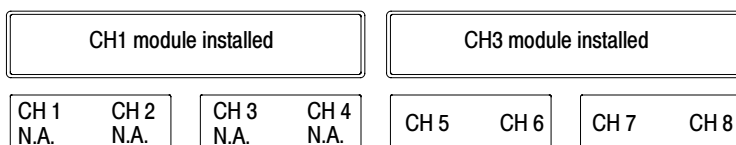

Seven channels: One large module, installed in CH3 compartment and three small modules



Seven channels: One large module, installed in CH1 compartment and three small modules



## Powering the Instrument On and Off

1. Insert AC power cord.
2. Toggle the mains switch to on.

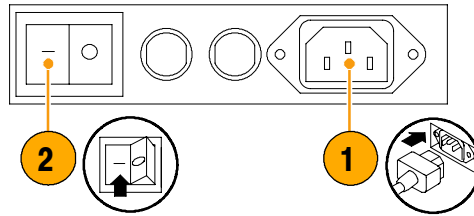

3. Use the front panel power button to switch the instrument on and off.

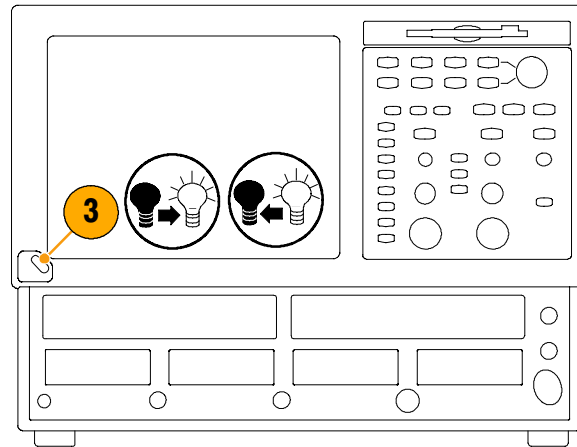

### Quick Tip

- When turning off the instrument, Windows and all applications automatically shut down before the instrument powers off.



**CAUTION.** To prevent damaging the modules, do not install or remove any modules while the instrument is powered on.

---



## Creating an Emergency Startup Disk

Create an emergency startup disk that you can use to restart your instrument in case of a major hardware or software failure. Store this disk in a safe place.

1. Select the minimize icon, gaining access to the Start menu.



2. Select **Start > Programs > Accessories > System Tools > Backup**.

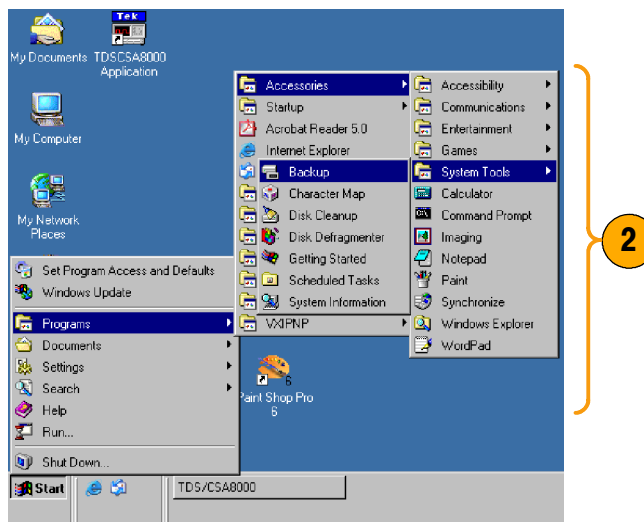

3. Select **Emergency Repair Disk** and follow the on-screen instructions.

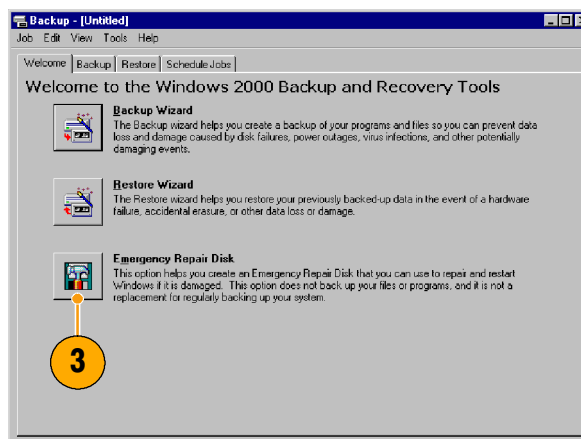

## Adding a Second Monitor

You can operate the instrument while using Windows and installed applications on an external monitor. Use the Settings tab in the Windows Display Properties dialog box to set up a dual-monitor configuration. Both the oscilloscope and the second monitor must have the color setting set to True Color.

1. Power off the instrument.

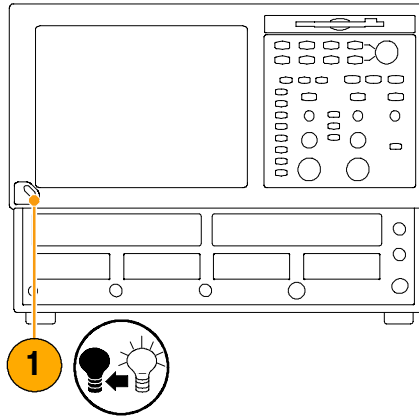

2. Connect a video cable (not supplied) from the video port on the back of the instrument to the external monitor.

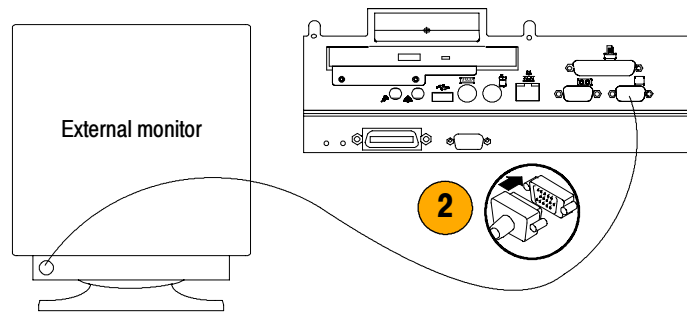

3. Power on the instrument.
4. Power on the external monitor.

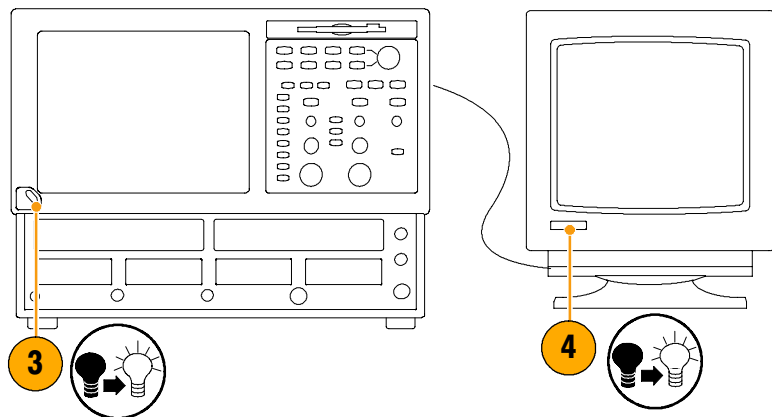

- In the Start menu, select **Settings** and then **Control Panel**.

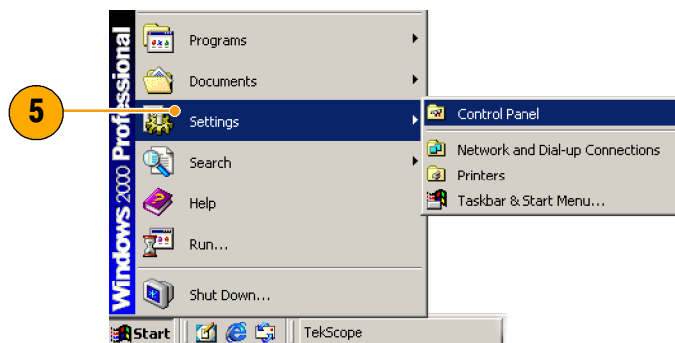

- Select **Display**.

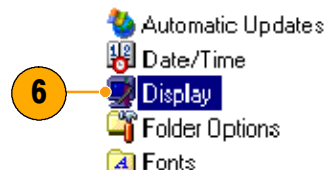

- In the Display Properties window, select the **Settings** tab.

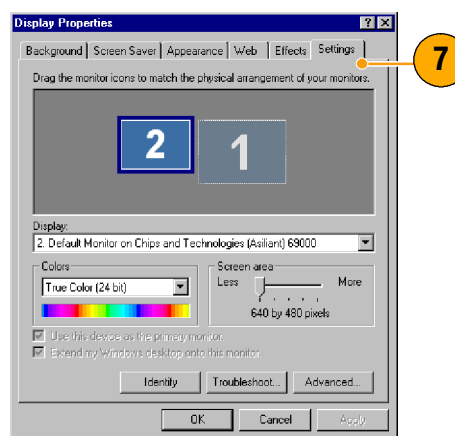

- Select the second monitor.
- Select **Extend my Windows desktop onto this monitor**. Make sure that both monitors are set to True Color.
- Click **Apply**, and then click **OK**.

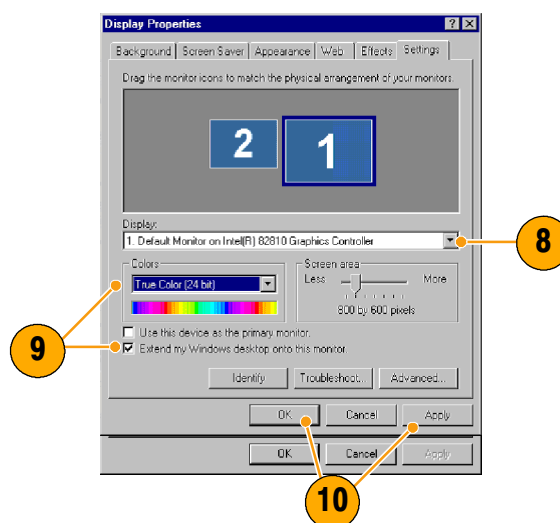

## Changing the Windows Language

Use the following procedure to change the Windows language from English to one of your choice. This procedure does not change the language of the user interface or the online help in the TekScope application. Before you begin, minimize the TekScope application.

1. Select **Settings** and then select **Control Panel**.

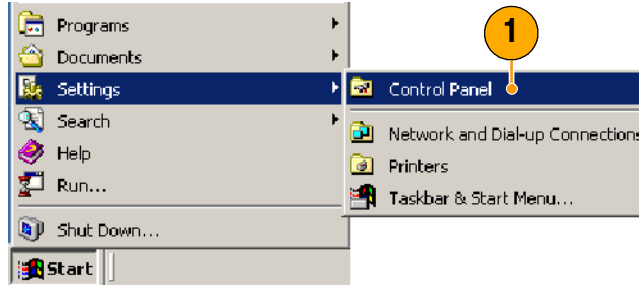

2. Select **Regional Options**.

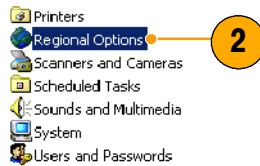

3. Select your locale, and then select your menu and dialogs language.

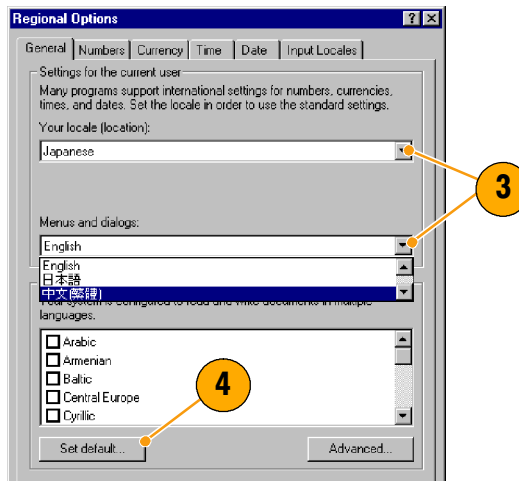

4. Click **Set default...**

5. Select locale.

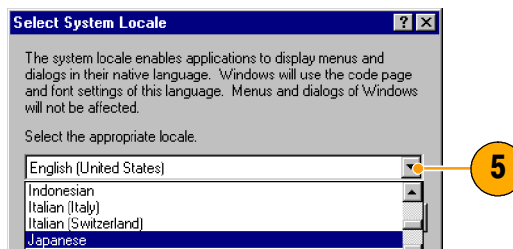

6. Click **Add** to add the input locale.

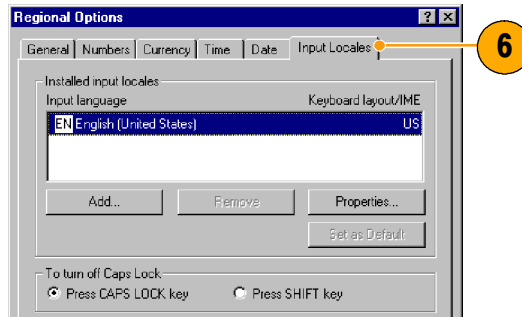

7. Select the Input locale and Keyboard layout/IME.

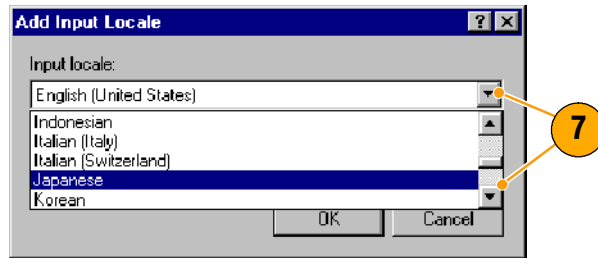

8. Select the Installed input locale, and click **Set as Default**.

9. Click **OK**.

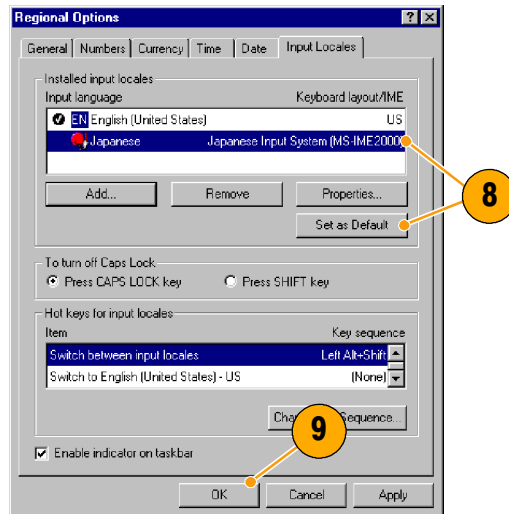

10. Click **Yes** in each dialog box.

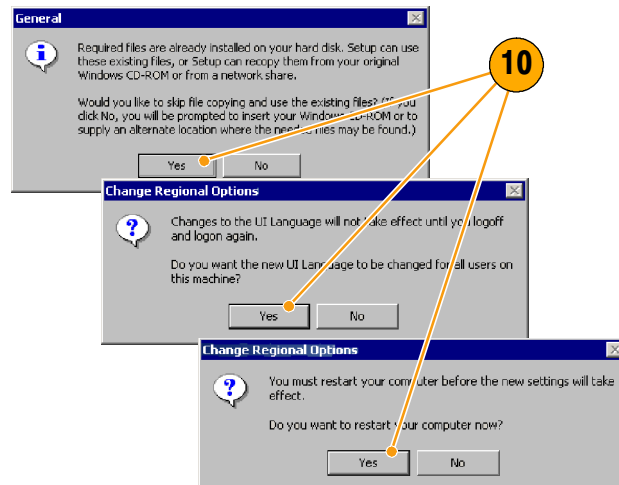

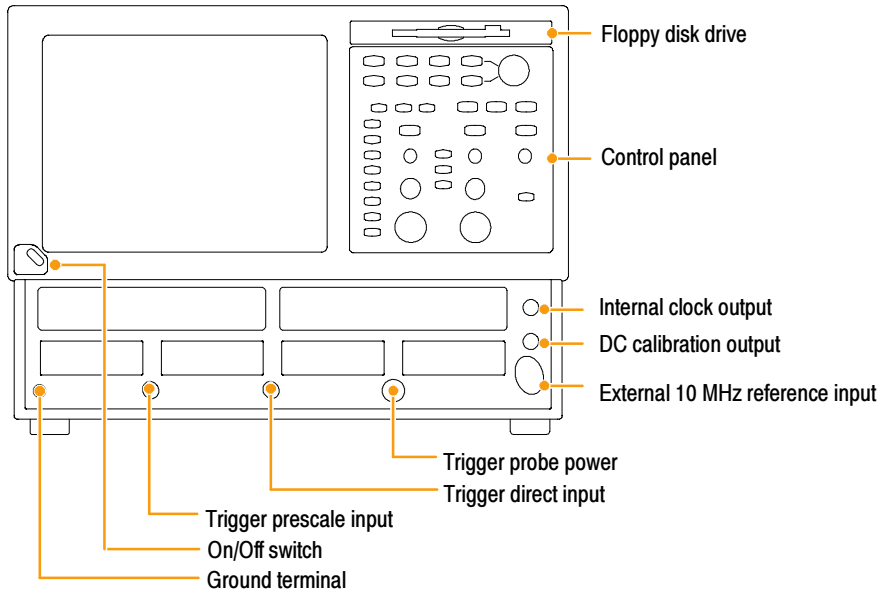

# Getting Acquainted with Your Instrument

## Front Panel

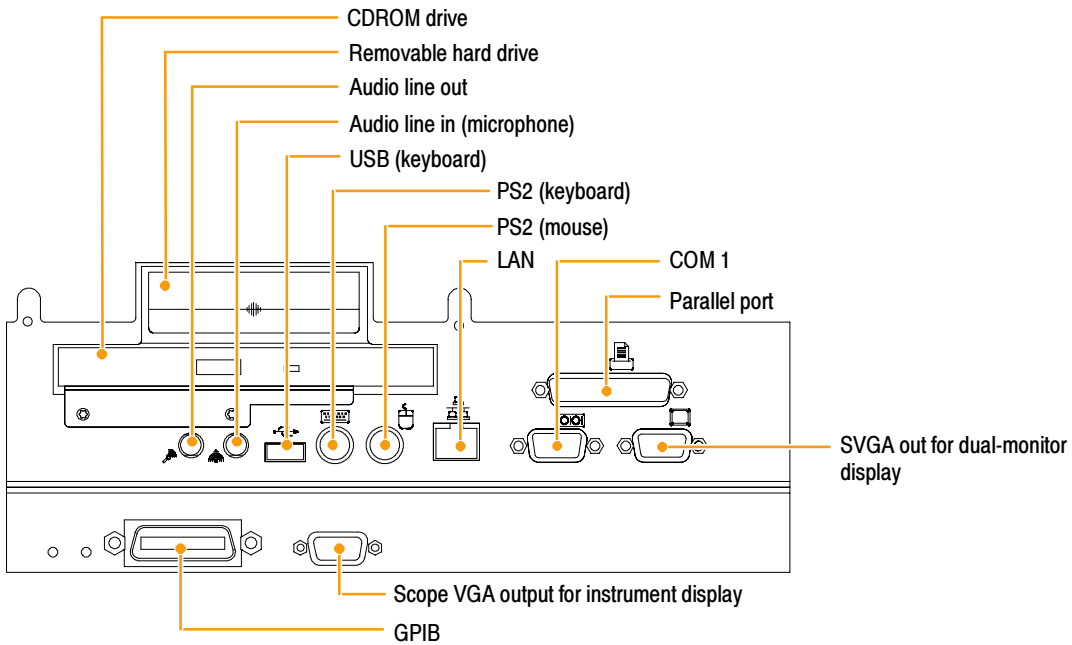

## Rear Panel



 Gated trigger Option GT (lower right corner)

## Interface

The menu bar provides access to commands that control all of the instrument features and functions. The toolbar provides access to the most common features.

Hovering the cursor over button or setting displays a brief description of its function, called a tooltip.

**Tool Bar:** Access to key features: printing, setup dialogs, math setup, waveform database, autoset, clear data, acquisition mode, triggering, and applications

**Menu Bar:** Access to data I/O, printing, online help system, and set-up functions

**Status Bar:** Trigger status and waveform count

**Measurements Bar:** Access to automated measurements by signal type and category; click measurement buttons to measure the selected waveform

**Readout Bar:** Toggle individual readouts on and off by clicking its button

**Phase Reference Status:** Indicates the characterization status of the phase reference module

**A Readout:** Right click any readout to display a short-cut menu providing handy access to often-used setup controls and properties for the feature associated with the readout

**Readouts:** Display up to five readouts in this area, selectable from the Readout Bar

**Display:** Live, reference, and math waveforms display here, along with cursors, masks, etc. to analyze them

**Waveform Bar:** Access to waveform selection (click), waveform position (drag), and waveform properties (right-click)

**Controls Bar:** Quick access to waveforms and timebases for display, and to their scale, offset, and position controls for adjustment

**Compensation Indicator:** Indicates the compensation status of modules and mainframe

The screenshot shows a Tektronix oscilloscope interface with a central display area showing a waveform. The interface includes a menu bar at the top, a toolbar below it, and a status bar at the bottom. On the right side, there is a readout bar with several readouts, including a phase reference status indicator and a measurement readout showing a frequency of 2.414279 GHz. The central display area shows a waveform with a vertical cursor and a horizontal reference line. The bottom of the screen shows a controls bar with various settings for the waveform and timebase.

## Control Panel

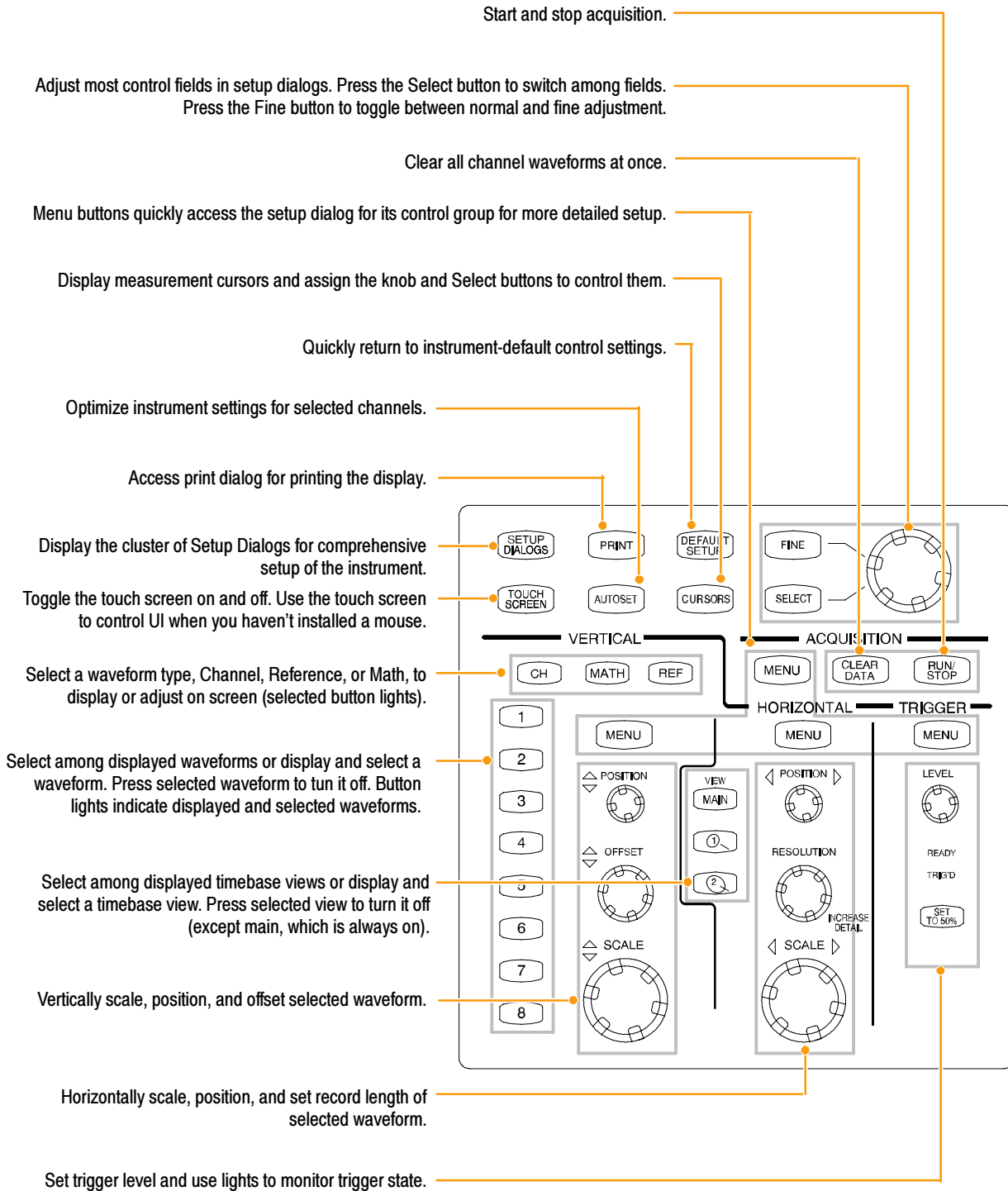



## Display - Single Graticule View

Drag the Horizontal Reference to move the point around which the horizontal scaling expands and contracts the waveforms.

Drag cursors to measure waveforms on screen.

Drag the waveform icon vertically to position waveform.

Right click on a waveform or its icon for handy access to often used setup controls and properties.

Drag ground reference icon to add offset to a waveform.

Drag across the waveform area to zoom the boxed waveform segment to full screen width.

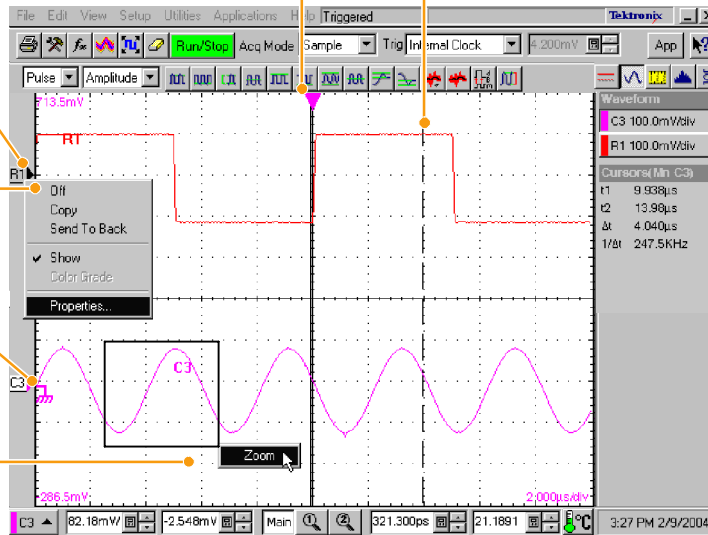

## Display - Multiple Views

Drag the markers to enclose the portion of waveform to appear in Mag 1 View.

Drag the markers to enclose the portion of waveform to appear in Mag 2 View.

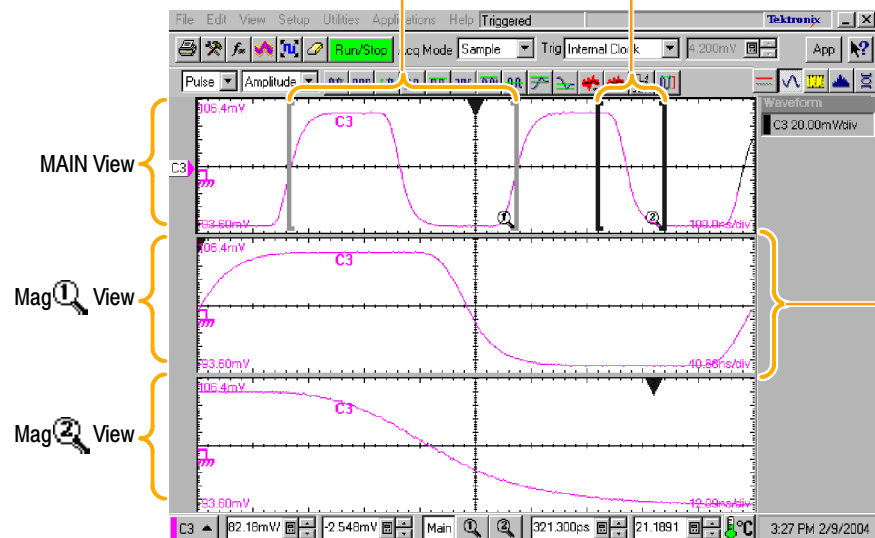

Drag the border between graticules to vertically size Main, Mag1, and Mag2 Views.

## Accessing Online Help

In-depth information about all the features of your instrument is available in the online help.

For a brief description of controls, move your mouse pointer and let it rest over a control, such as a menu name, a menu item, tool-bar button, or tool-bar readout. The help system displays a short definition or a label (tooltips) of the control.

For a more detailed description, click the What's This? button in the main display or in a dialog box.

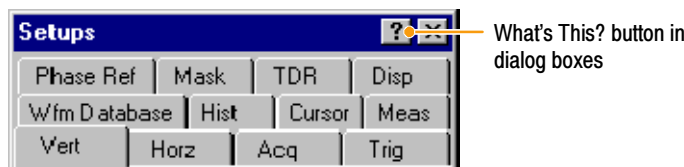
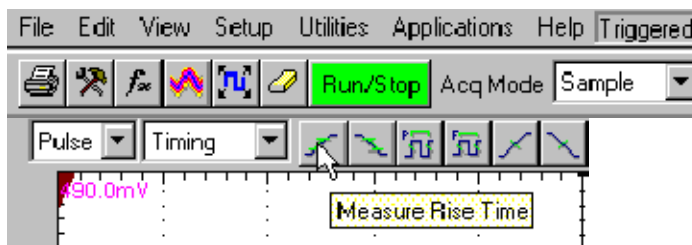

After clicking the What's This button, click on the control you want described. A popup box describes the control.

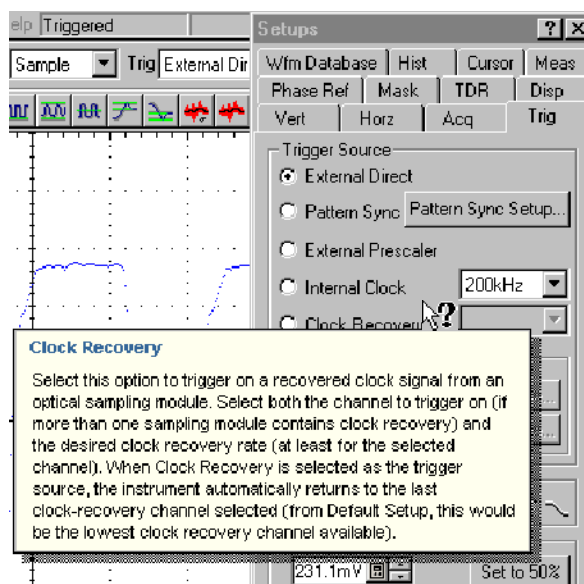

For in-depth, contextual overviews, most dialog boxes have a Help button. Click the button to open the help system with an overview of the dialog box that's currently displayed.

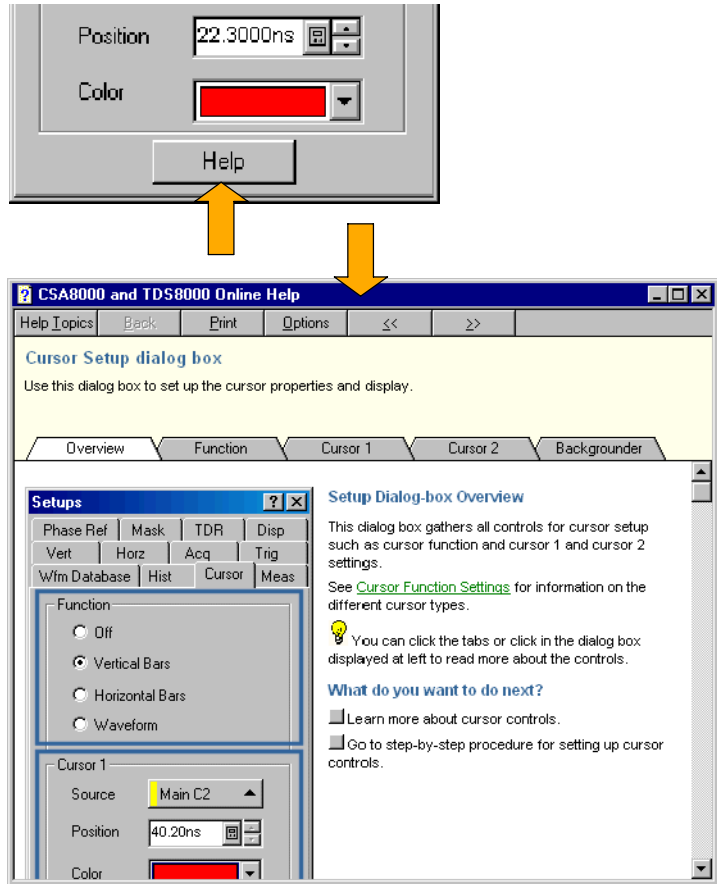

You can search for in-depth help from the application menu bar: select **Help**, and then select **Contents & Index**.

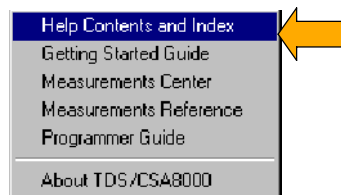

# Inspect Your Instrument

Use the following procedure to verify the functionality of your instrument. For a complete performance verification, see the Performance Verification section in the optional service manual.

## Verify Internal Diagnostics Pass

1. Install all modules to be diagnosed.
2. Power on the instrument and wait 20 minutes for the warm-up period.

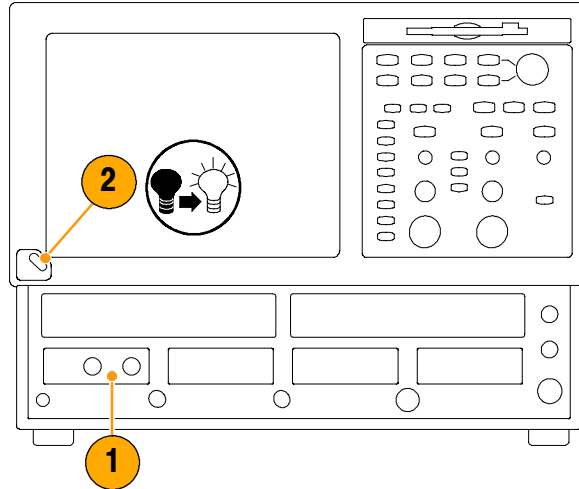

3. Select **Diagnostics...**

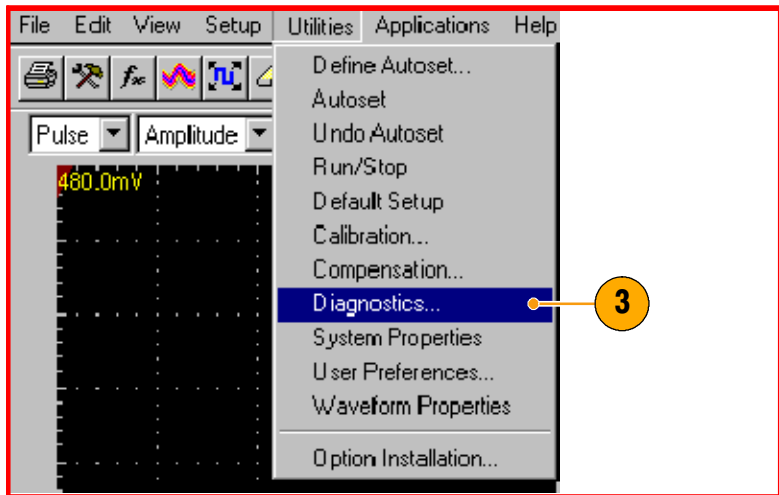

4. Select the **Subsystem Level** tab.
5. Select all the entries by clicking the first entry **Control Proc** and dragging down to select the rest. All entries should be highlighted as shown above.
6. In the **Run** box, leave **Loop** and **Halt on Failure** unchecked.
7. Click **Run**.
8. Verify that **Pass** appears as **Status** in the dialog box when the diagnostics complete. If diagnostic failures occur, contact your local Tektronix service personnel.

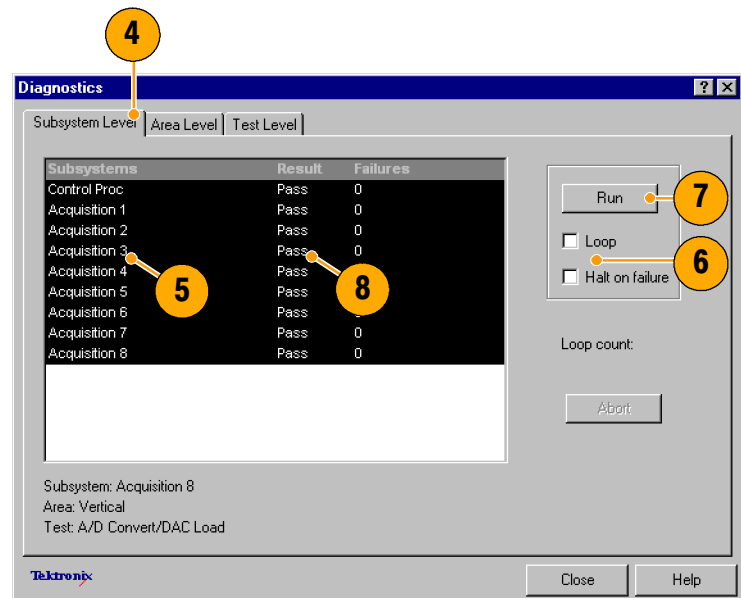

## Optimizing Measurement Accuracy

This instrument can compensate itself and the sampling modules installed, optimizing the internal signal path used to acquire the waveforms you measure. Compensation optimizes the capability of the instrument to make accurate measurements at the ambient temperature.

---

**NOTE.** After first installing a sampling module(s) or moving a sampling module from one compartment to another, run Compensation from the Utilities menu to ensure that the instrument meets its specifications when reaching a stable equilibrium after power-up (normally 20 minutes is recommended).

You must save the compensation results or they will be lost when the instrument is powered down.

---

### Signal Path Compensation

This procedure compensates the signal path of each installed module (for the current temperature) to enhance measurement results.

Use this procedure for any of the following conditions:

- A module has been added to the instrument or a module has been moved to another compartment.
- The temperature has changed more than 5 °C since the last signal path compensation.

When making measurements at vertical scale settings less than or equal to 5 mV/div, perform the signal path compensation once a week. Failure to do so may result in the instrument not meeting warranted performance levels at those volts/div settings.

1. Install all modules to be compensated.
2. Install all terminations and dustcovers.  
Failure to install the 50 Ω terminations on electrical inputs can yield erroneous compensation failures or results.
3. Power on the instrument and wait 20 minutes for the warm-up period.

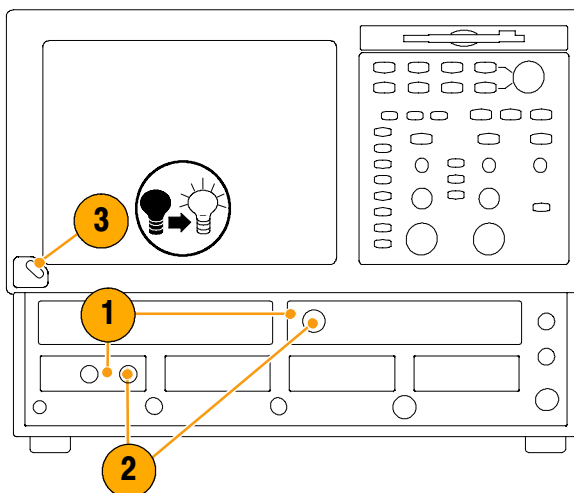

4. Select **Compensation...**

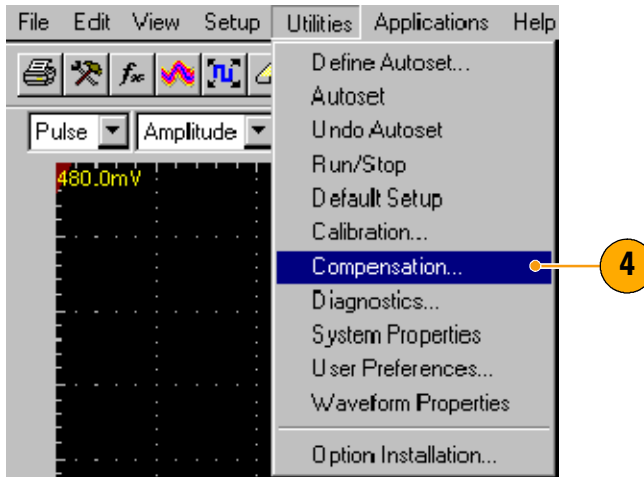

5. In the Compensation dialog box, the main instrument (mainframe) and sampling modules are listed. The temperature change from the last compensation is also listed.

6. Wait until the Status for all items you want to compensate changes from **Warm Up** to **Pass**, **Fail**, or **Comp Req'd**.

7. Under Select Action, select **Compensate and Save** (default).

8. From the top dropdown list, choose **All** (default selection) to select the main instrument and all its modules as targets to compensate.

9. Click the **Execute** button to begin the compensation.

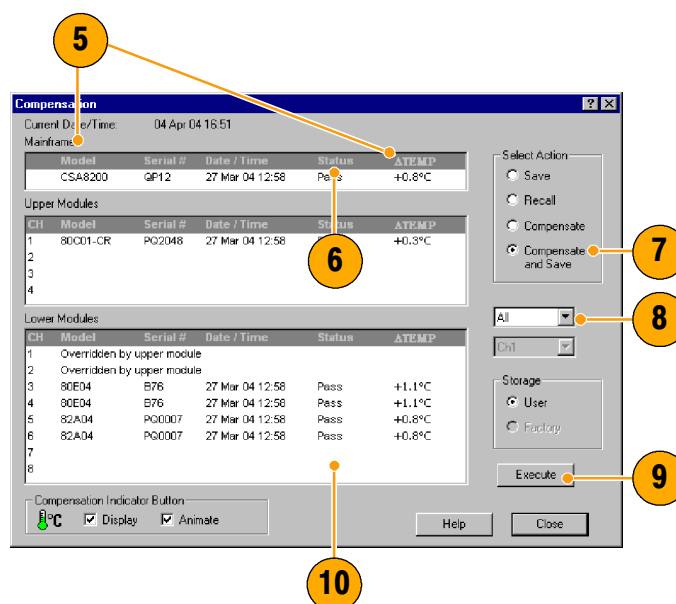

Follow the instructions to disconnect inputs and install terminations that appear on screen; be sure to follow static precautions (see the user information for your sampling module) when following these instructions.

10. Verify that the compensation routines pass.

If **Fail** appears as **Status**, rerun the compensation. If **Fail** status continues and you have allowed warm up to occur, the module or main instrument may need service.

## Perform Dark-Level and User Wavelength Gain Compensations

Performing a dark-level compensation maximizes the accuracy of the extinction ratio and other optical automatic measurements you take. Performing a User Wavelength Gain compensation optimizes an optical channel for your custom input signal.

**NOTE.** Dark-level compensation performs a subset of the module compensation process. It is designed to be fast so it can be performed frequently, just before measurements are taken. This compensation is not saved and is only valid for the selected bandwidth or filter path and the internal optical power meter.

You should perform the procedure Signal Path Compensation on page 20 to compensate all vertical bandwidth and filter selections.

Use the following procedure to perform either compensation; this procedure applies only to optical modules.

1. Install at least one optical sampling module in the instrument to be dark-level calibrated. Set the acquisition system to run continuously.

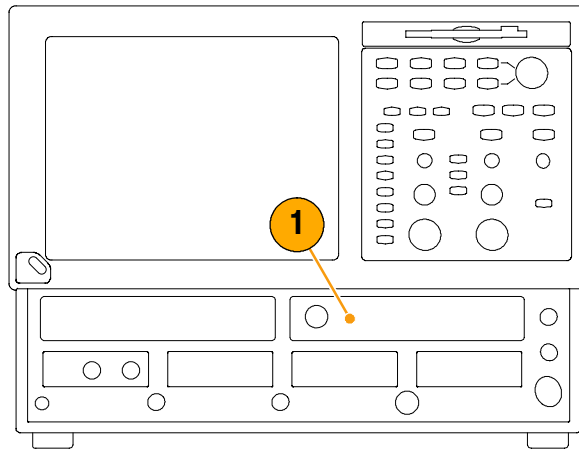

2. Use the Vertical buttons to select the channel to be compensated.

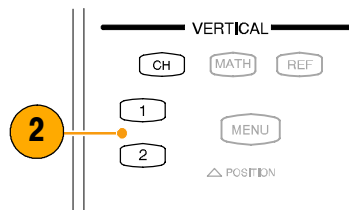

3. From the application menu bar, click **Setup**, and then click **Vertical**.

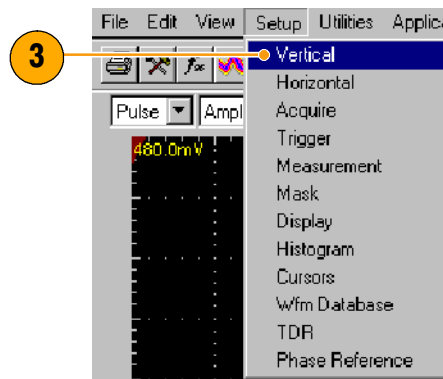



To run the Dark-Level compensation:

4. In Vert Setup dialog box, click the **Dark Level** button under Compensation. Follow the instructions on screen.

Repeat steps 2 and 4 for any additional optical channels you want to compensate.

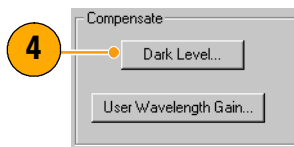

To run the User Wavelength Gain compensation (for custom input signals):

5. Attach an optical signal, with a precisely known amount of optical power, to the optical module input.

Use an independently-calibrated average optical power meter to measure this power precisely. Then connect the signal to the optical module using the same fiber cables.

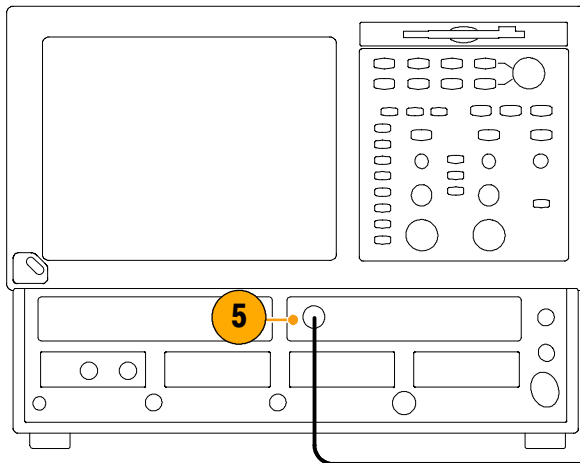

6. In Vert Setup dialog box, click the **User Wavelength Gain** button under Compensation. Follow the instructions on screen.

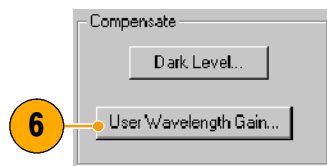

7. In the User Wavelength Gain Compensation dialog box, set the wavelength and power of the signal to be applied to the channel.

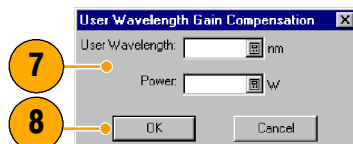

8. Press the **OK** button to execute the compensation.

# Acquisition

This section contains concepts of and procedures for using the acquisition system. Detailed information is available in the online help.

## Setting Up Signal Input

Use front-panel buttons to set up your instrument to acquire the signal.



**CAUTION.** Sampling modules are inherently vulnerable to static damage. Always observe static-safe procedures and cautions as outlined in your sampling-module user manual.

1. Connect to the signal to be acquired using proper probing/connecting techniques. See the user manual for the sampling module you have chosen.
2. Connect an appropriate trigger signal to the instrument.

Refer to *Triggers* beginning on page 30 for information about trigger settings, controls, and inputs.

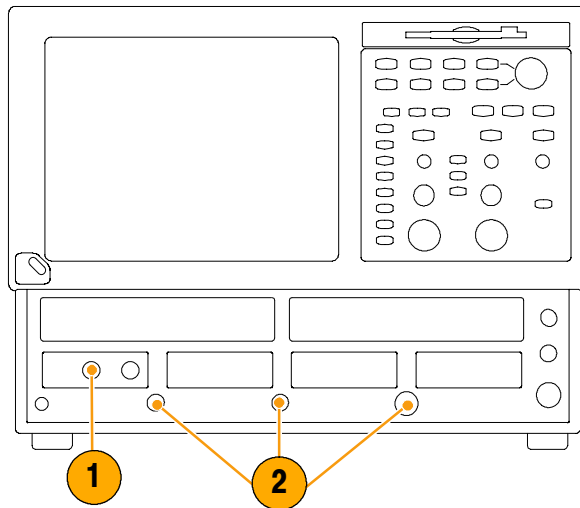

3. Push the **CH** button (turns amber) to assign the waveform buttons (**1 - 8**) to operate on channel waveforms, then select the proper waveform button.

A waveform button lights when its channel is on; when on but not selected, its button is lighted green; when on *and* selected, its button is lighted amber.

Pushing the **MATH** button assigns the waveform buttons to math waveforms. If no math waveforms are defined, the Define Math dialog box appears.

Push the **REF** button to assign the waveform buttons to reference waveforms. If no reference waveforms are defined, the Recall Waveform dialog box appears.

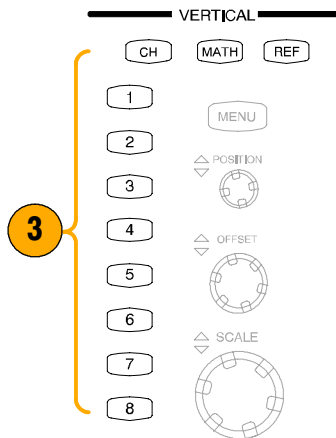

4. Use the Vertical **Offset** knob to adjust the selected waveform on screen. Use the Vertical **Scale** and **Position** knobs to adjust the display.

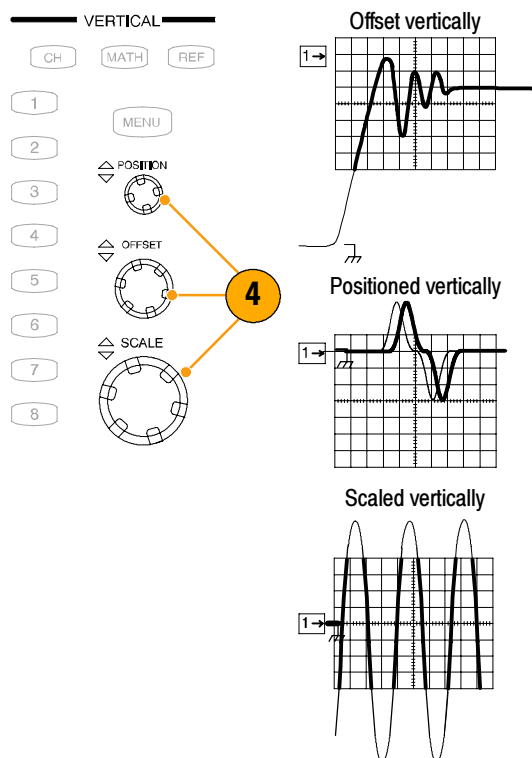

5. Push the **View Main** button to make sure that the main time base view is selected. Use horizontal knobs to scale and position the waveform on screen and to set sample resolution.

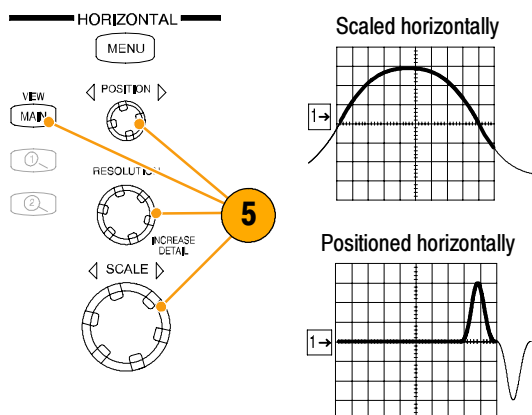

### Quick Tips

- You can click a waveform trace or its reference indicator with the mouse pointer (or touch screen) to select it.
- Push **AUTOSET** to quickly set up instrument parameters based on the input signal.
- Press **Set to 50%** in the Trigger controls, if required, to stabilize the display when using the Trigger Direct Input connector.

## Using Autoset

Use Autoset to quickly and automatically set up the instrument (vertical, horizontal, and trigger parameters) based on the characteristics of the input signal.

1. Push the **AUTOSET** button to execute an Autoset.

If you use Autoset when one or more channels are displayed, the instrument uses the selected channel for horizontal scaling. Vertically, all channels in use are individually scaled.

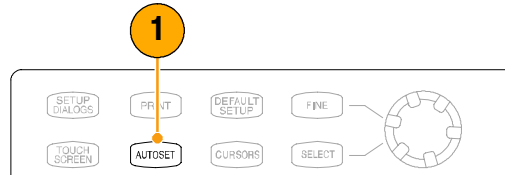

### Quick Tip

- Use the Define Autoset in the Utilities menu to display and change the Autoset properties.

## Using Default Setup

1. To quickly return to the factory default settings, push **DEFAULT SETUP**.

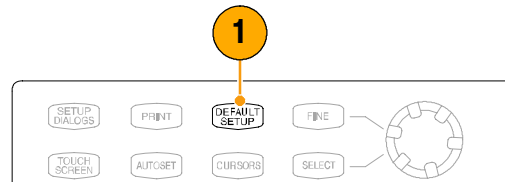

2. Click **YES** to restore the settings.

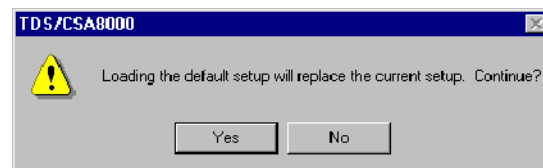

## Accessing the Setup Dialog Boxes

1. You can access the Setup dialog boxes by using the front panel buttons, the file menu, or the toolbar.

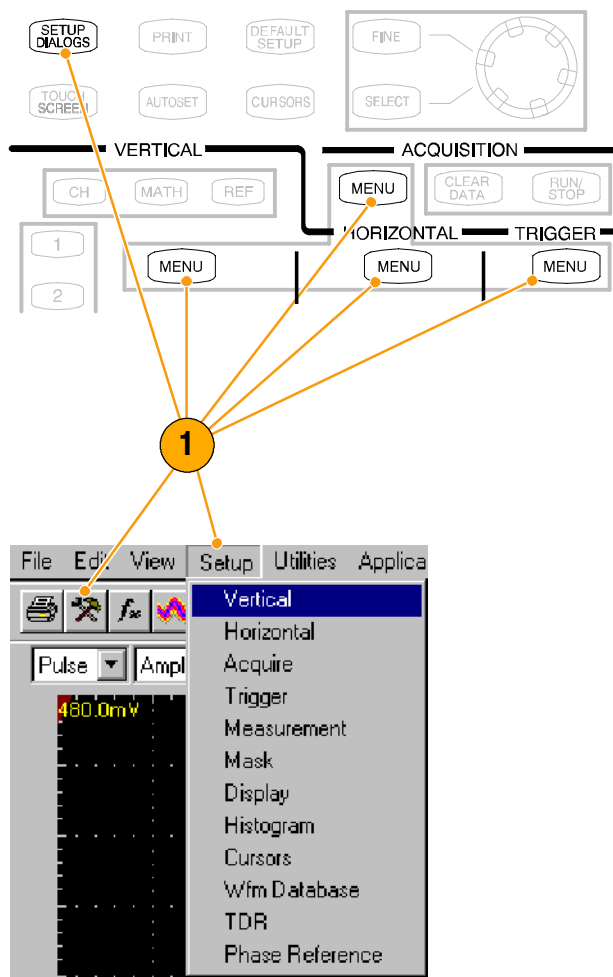

2. Click on the tabs to select among the setup dialog boxes.

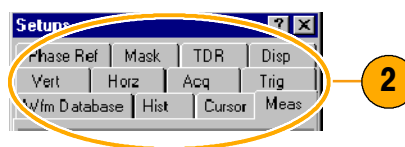

## Changing the Acquisition Mode

Use the procedure that follows to set the data-acquisition mode and specify acquisition start and stop methods.

1. Press the Acquisition **MENU** button to display the Acq Setup dialog box.

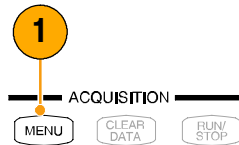

2. Select the acquisition mode.
3. For Average mode, enter the number of samples to average.
4. Set the Stop After mode and action by selecting one of the following options:

- Run/Stop Button Only
- Condition

5. If you selected Condition, choose a condition to stop on from the drop-down list. If the condition requires a count, enter a count.

6. Select a **Stop Action** action from the drop-down list. Choose from the following actions:

- None
- Print Screen to File
- Print Screen to Printer
- Save all Waveforms

Enter a filename if you've selected **Print to File** or **Save all Waveforms**.

7. Select **Ring Bell** if you want an audio notice when the acquisition stops.
8. Press **RUN/STOP** to start the acquisition.
9. Press **RUN/STOP** again to stop the acquisition.

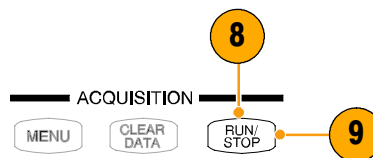
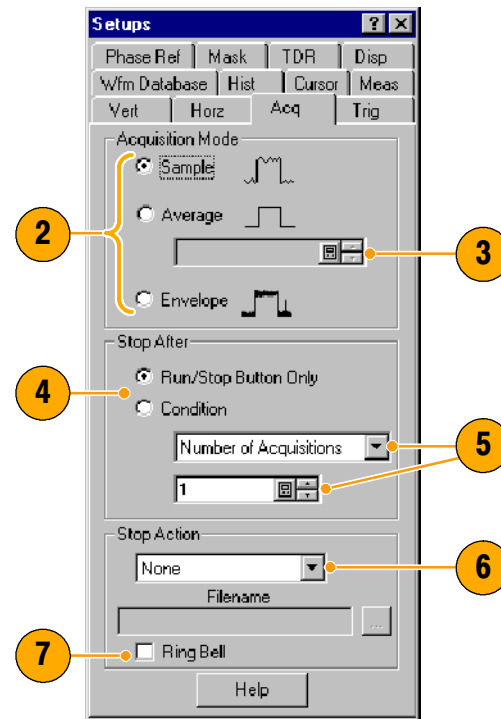

### Quick Tips

- Run/Stop is available on both the front panel and the touch screen.
- If Stop After is set to Condition, pressing RUN/STOP causes only one acquisition to run if the original condition has been met. You need to press CLEAR DATA so that the condition must be met again.

## Setting the Display Style

1. Select **Disp** to start setting the display styles.
2. Choose a display style.

**Normal** selects a display with no acquisition data persistence.

Waveforms are displayed with the new data from ongoing acquisitions replacing data acquired from previous acquisitions.

**Show Vectors** turns on display lines between waveform dots; deselect to display only dots.

Select an Interpolation mode from the pulldown list.

- **Sin(x)/x** interpolation computes record points using a curve fit between the actual samples acquired.
- **Linear** interpolation computes record points between actual acquired samples by using a straight line fit.

**Variable Persistence** makes data persist for a specified time. New waveform displays accumulate data as new waveform records acquire, but with continuous replacement of the oldest data.

Set a time at which the oldest data is removed.

**Infinite Persistence** makes data persist until you change some control or explicitly clear the data. Waveform displays accumulate data as new waveform records acquire, resulting in a build up of data in all time slots.

3. Use the Graticule settings to select the graticule style and the graticule color and screen background.

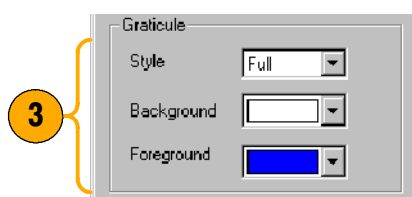
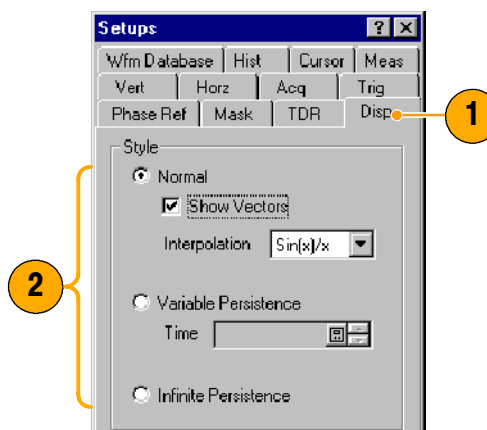

# Triggers

This section contains concepts and procedures for using the trigger system. Detailed information is available in the online help.

## Triggering Concepts

### Trigger Event

When a trigger event occurs, the instrument acquires a sample in the process of building a waveform record. The trigger event establishes the time-zero point in the waveform record and all samples are measured with respect to that event. The trigger event starts waveform acquisition. A trigger event occurs when the trigger source (the signal that the trigger circuit monitors) passes through a specified voltage level in a specified direction (the trigger slope). When a trigger event occurs, the instrument acquires one sample of the input signal. When the next trigger event occurs, the instrument acquires the next sample. This process continues until the entire record is filled with acquired samples. Without a trigger, the instrument does not acquire any samples. This behavior differs from that of real-time acquisition systems, which can acquire a complete waveform record from a single trigger event.

### Trigger Type

This instrument supports edge triggering only, in which edge triggers gate a series of acquisitions. The slope control determines whether the instrument recognizes the trigger point on the rising or the falling edge of a signal. You can set the trigger slope from the toolbar at the top of the display or in the Trigger Setup dialog box. The level control determines where on that edge the trigger point occurs. You can set the trigger level from the front panel with the Trigger LEVEL knob. The slope and level controls apply only when the trigger source is set to External Direct (using the TRIGGER DIRECT INPUT connector).

### Trigger Modes

The trigger modes control the behavior of the instrument when not triggered:

*Normal* mode sets the instrument to acquire a waveform only when triggered. Normal mode does not acquire data if triggering stops; the last waveform records acquired remains “frozen” on the display (if the channels containing them are displayed). If no last waveform exists, none is displayed.

*Auto* mode sets the instrument to acquire a waveform even if a trigger event does not occur. Auto mode uses a timer that starts after trigger rearm. If the trigger circuit does not detect a trigger before this timeout (about 100 ms), it auto triggers, forcing enough trigger events to acquire all active channels. In the case of repetitive acquisitions in automatic trigger mode, waveform samples are acquired, but at different places in the data stream (synchronization is lost). If you do not apply a signal to any displayed channel, a baseline is displayed for that channel.

### Trigger Sources

The trigger source provides the signal that the trigger system monitors. The source can be:

- The internal clock of the instrument (TDR clock rate), with user-selectable clock frequencies. The INTERNAL CLOCK OUTPUT connector supplies a replica of the internal clock at the instrument front panel.



- An external signal coupled to one of the trigger input connectors on the front panel.
  - External Direct, DC coupled and usable with signals up to at least 3.0 GHz
  - External Prescale, divided by 16 and usable with signals from 2.0 GHz up to at least 12.5 GHz
- An internal clock-recovery trigger provided by an optical sampling module equipped with a clock-recovery option or a dedicated electrical clock recovery module. Clock recovery is user-selectable for triggering rates that depend on the sampling module used; for example, either 622 Mbps (OC-12/STM-4 standards) or 2.488 Gbps (OC-48/STM-16 standards) for the 80C01-CR Optical Sampling Module.
- A pattern (frame) trigger provided by a PatternSync trigger module such as the 80A06 PatternSync Trigger Module. The output of the pattern sync trigger module must be connected to the EXTERNAL DIRECT TRIGGER INPUT connector on the front panel.

Use a trigger source that is synchronized with the signal you are sampling and displaying. Selection of your trigger source depends on your application, as shown in Table 1.

**Table 1: Application-based triggering**

Application	Source to use
Communications (optical) serial NRZ data signals	Set source to Clock Recovery, set the clock-recovery type, and use an optical sampling module equipped with a clock-recovery option supporting the specific data rate of the serial optical signal.  The available clock recovery rates depend on the sampling module installed.
TDR measurement using an electrical sampling module equipped with TDR	Set source to Internal Clock to use the internal clock of the instrument (TDR clock), and select the appropriate clock frequency. Disconnect any signal connected to the External 10 MHz Reference Input when using the Internal clock.
Measurements on systems with a synchronized pretrigger signal	Set source to External Direct or External Prescaler as appropriate and connect the pretrigger signal.
Any application requiring that the input signal provide the trigger	Set source to External Direct or External Prescaler as appropriate. Use a signal splitter or power divider to couple to both the Ext Direct or Prescaler input and the input channel, so that the sampled signal is also the trigger signal.
Any application requiring that you probe the trigger source	Set source to External Direct and use a Tektronix probe.
Any application requiring that you perform special measurements using gated trigger	Set source to External Direct, select Gated Trigger, and use a TTL connection to trigger gate.

## Trigger Source Connectors

External triggers can be connected to either the TRIGGER DIRECT INPUT or TRIGGER PRESCALE INPUT connectors on the front panel:

- Signals connected to the PRESCALE connector are divided by eight and then fed to the trigger circuits.
- Signals connected to the DIRECT connector are fed directly to the trigger circuitry. The signal is DC coupled and can be up to 3.0 GHz.

When using a given trigger source, disconnect any other trigger source from the front panel to ensure specified performance. Specifically:

- Do not connect a signal to the TRIGGER DIRECT or TRIGGER PRESCALE front-panel connector unless you've selected that input as the trigger source in the Trigger setup dialog box.
- Do not connect a signal to the External 10 MHz Reference front-panel connector unless you have selected that input as the timebase mode in the Horizontal setup dialog box.

### Gated Trigger Connector (Option GT Equipped)

You can attach a BNC cable to the External Gate input at rear panel (TTL connection) to selectively exclude data from acquisition by means of gating the trigger on and off. Several conditions must be met to get a stable display of waveform data:

- The channel and trigger must be otherwise triggerable without the trigger gate.
- The gating signal must be at a TTL high.
- The triggering system must be enabled and the instrument will acquire.

### Enhanced Triggering

These features can help stabilize triggering and perform special measurements:

- **High Frequency Triggering.** High Frequency triggering increases trigger sensitivity of the trigger circuit by decreasing hysteresis (a transition or noise band), allowing triggering on higher frequency signals.
- **Gated Triggering.** Gated triggering takes the trigger and the External Gate input and applies them to the instrument through what is in effect an AND function. Gated triggering can be used for applications such as simulations of undersea communication fibers where test fixtures are used to repeat the test signal through a short loop of cable to simulate traveling longer distances. The trigger gate can be used to ignore triggers until the signal has traversed the loop many times.

---

**NOTE.** *Metastability Reject enhanced triggering was removed with software version 2.4. This control was provided for compatibility with previous CSA8000 and TDS8000 series instruments but had no function with the CSA8200 and TDS8200 instruments.*

---

### Trigger Holdoff

Trigger holdoff can help stabilize triggering. When you adjust holdoff, the instrument changes the time it waits before rearming its trigger circuit after acquiring a sample. Before rearming, trigger circuitry cannot recognize when the next trigger conditions are satisfied and cannot generate the next trigger event. When the instrument is triggering on undesired events, you can adjust holdoff to obtain stable triggering.

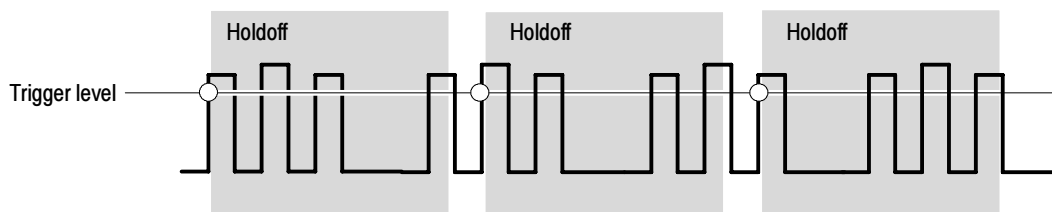

○ Indicates trigger points

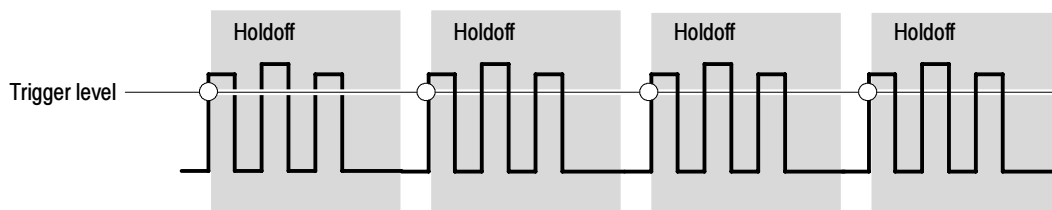

At the longer holdoff time for the top waveform, triggering occurs at valid, but undesired, trigger events. With a shorter holdoff set for the bottom waveform, triggers all occur on the first pulse in the burst, resulting in a stable display.

## Setting Trigger Controls

Nearly all trigger parameters are set in the Trigger Setup dialog window.

1. Press the trigger **MENU** button to display the Trig Setup dialog box.
2. Select a trigger source: External Direct, Pattern Sync, External Prescaler, Internal Clock and rate, Clock Recovery, Source, and rate (with C1 and C2 selections).
3. Select a trigger mode: **Auto** or **Normal**.
4. Select the trigger slope.
5. Select a trigger level. Click **Set to 50%** to automatically set the trigger level to 50% of the trigger signal amplitude.
6. Set the trigger holdoff value.
7. Select an Enhanced Triggering setting.
8. If the trigger source is set to Pattern Sync, select **Pattern Sync Setup...** to display the Pattern Sync dialog box.

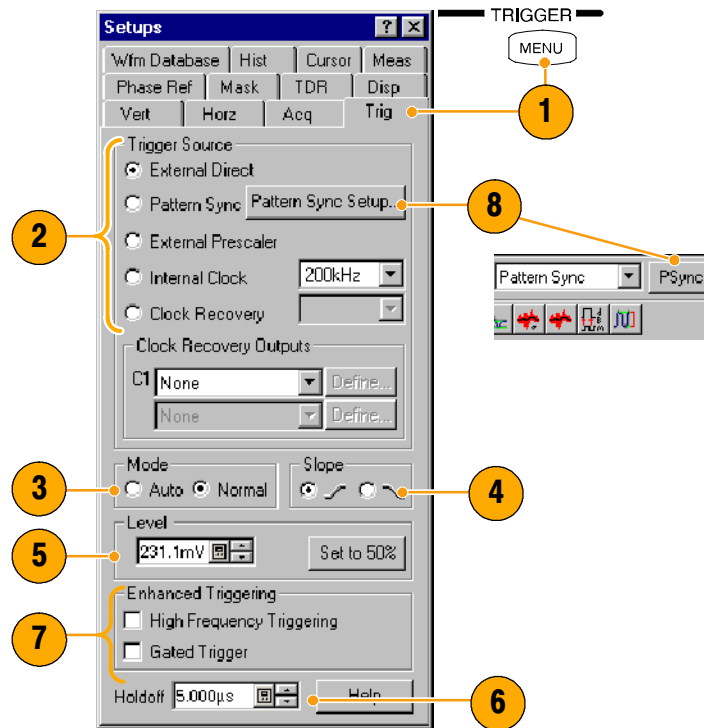

### Quick Tips

- Selecting External Direct as the trigger source requires an appropriate trigger signal be connected to the TRIGGER DIRECT INPUT connector.
- The Slope and Level controls apply only when the trigger source is set to External Direct.
- Selecting External Prescaler as the trigger source requires an appropriate trigger signal be connected to the TRIGGER PRESCALE INPUT connector.
- Selecting External Prescaler sets the trigger Mode to Normal.
- Selecting Internal Clock uses the clock frequency setting in the pulldown list.
- Selecting Clock Recovery requires that a module is installed with clock recovery available. Select the clock recovery standard from the pulldown lists or user-specified range controls.
- Gated Trigger is only available with Option GT.
- Pattern Sync trigger is only available if a PatternSync module is installed.
- The trigger output from the PatternSync module must be connected to the TRIGGER DIRECT INPUT connector.
- Selecting Pattern Sync as the trigger source presets several trigger controls to predefined settings appropriate for using the external TRIGGER DIRECT INPUT connector.

## Setting Pattern Sync Controls

The Pattern Sync dialog box can be displayed when Pattern Sync is the selected triggering source.

1. Select the parameters for the pattern sync module.
  - Select the channel Source where the pattern sync module is installed.
  - Select the Data Rate (bit rate) (default is 2.48832 Gbps).
  - Select the Pattern Length (default is 127).
  - Select a Data:Clock Ratio (data-to-clock ratio) (default is 1:1).
  - Select a Relative Trigger Bit (in the range of 0 to Pattern Length-1) (default is 0).
2. Use the AutoSync feature to automatically detect the data rate, pattern length and/or data-to-clock ratio of the applied data and clock signals (data to a sampling module channel and the clock to the Pattern Sync module).
3. Enable FrameScan to automatically scan through a pattern (or part of the pattern).

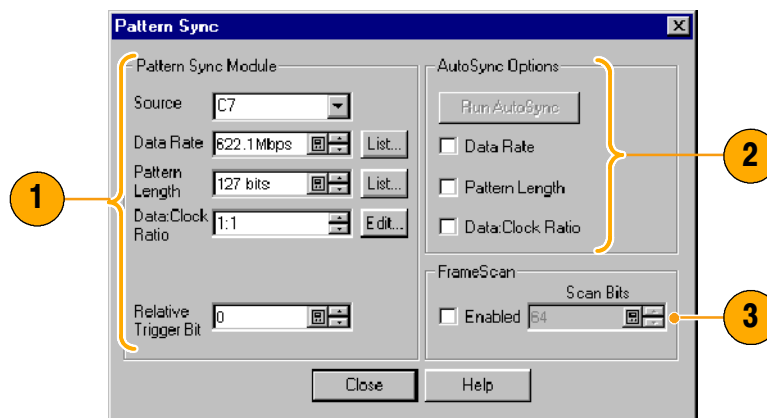

The FrameScan control is tied to the FrameScan control in the Horizontal Setup dialog box (changing either one affects the other).

### Quick Tips

- All pattern sync controls are disabled (greyed out) if there are no available pattern sync sources.
- The default selected pattern sync source is the lowest-numbered pattern sync module.
- The Data Rate in the Pattern Sync dialog box is tied to the Bit Rate control in the Horizontal setup dialog box (changing either one affects the other).
- If the entered Data Rate does not match the rate of the selected communication standard in the Horizontal Setup, then the communication standard is changed to "User".
- Using the PatternSync Trigger module in conjunction with FrameScan can improve both acquisition throughput and timing accuracy.

## Checking Trigger Status

You can check the status of the trigger from the front panel and in the status bar. The status bar also displays the waveform count.

If using a phase reference module (such as the 82A04) for triggering, refer to page 53 for information about phase reference triggering.

1. Check the READY and TRIG'D front-panel controls to determine the trigger status.

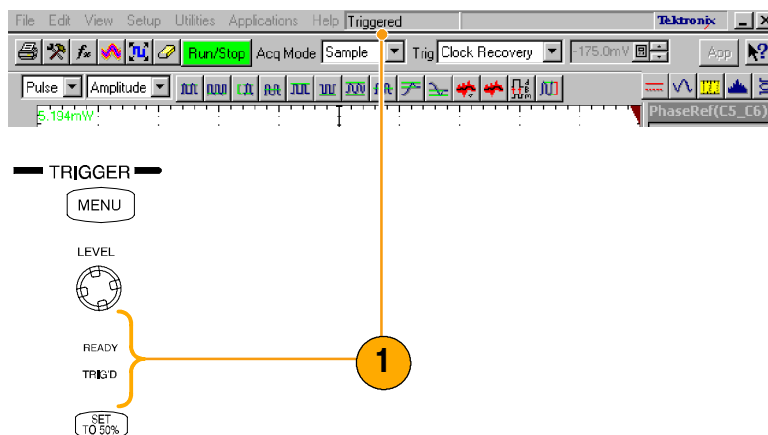

## Analyzing Waveforms

Your instrument features cursors, automatic measurements, statistics, histograms, and math to assist you in analyzing waveforms. This section contains concepts and procedures for analyzing waveforms. Detailed information is available in the online help.

### Taking Automatic Measurements

Automated measurements are divided into signal types: Pulse, NRZ (Non-Return-to-Zero), and RZ (Return-to-Zero). These are further divided into categories: amplitude, time, and area.

1. Use the Vertical buttons to select the waveform to be measured.

The waveform may be a channel, reference, or math waveform.

2. Select one of the signal (waveform) types and then select a category from the measurement bar.

3. Click the measurement you want in the measurement tool bar.

4. Read the results in the measurements readout.

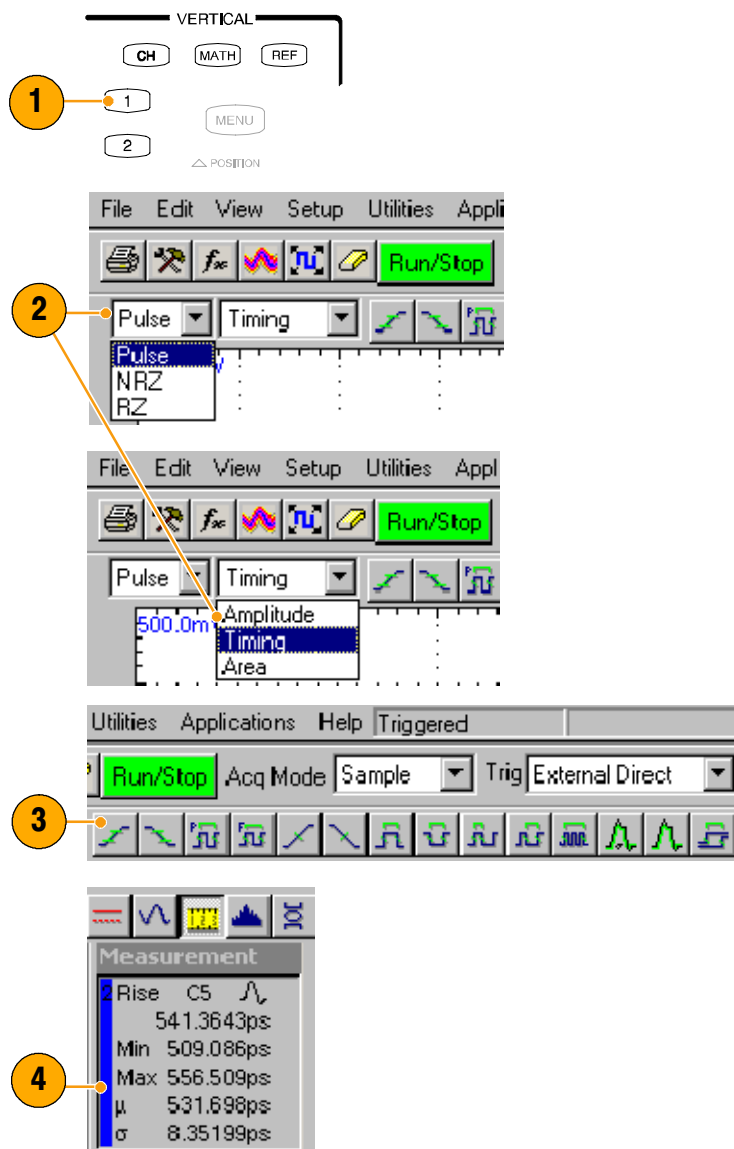

To see statistics:

5. Right click on any measurement readout to display its context menu.
6. Select **Show Statistics** to display measurement statistics in the measurement readout.

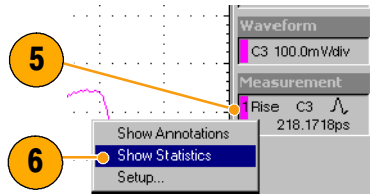

To show annotations:

7. Right click on any measurement readout to display its context menu.
8. Select **Show Annotations** to display annotations that indicate which portion of the waveform is being measured as well as reference levels for the measurement.
9. This is the portion of the waveform being measured.
10. These are the reference levels for the measurement.

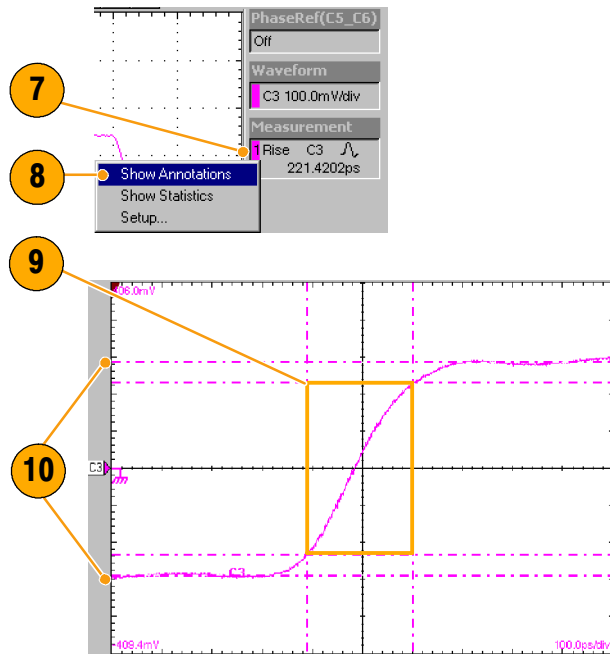



To measure a waveform database:

11. From the application menu bar, select **Setup**, and then select **Meas**.

In the Meas Setup dialog box, make sure the measurement (one of **Meas1** through **Meas8**) is selected.

12. In the Source tab, check the **Use Wfm Database** option.

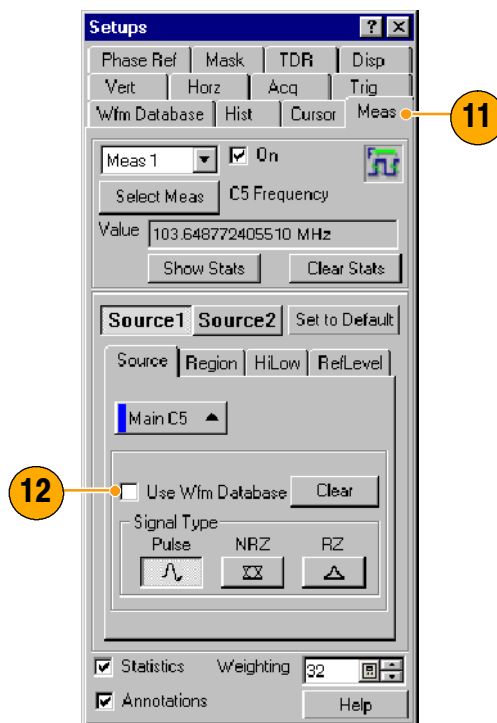

To localize a measurement:

13. Select **Meas**.
14. Select the **Region** tab to expose the gate controls.
15. Click the **On** box to turn gating on and to display the gates on screen.
16. Use the **G1 (Gate1)** and **G2** spin controls (or type in values) to adjust the gates on screen such that the area to measure is between the gates.
17. Click the **Annotations** box to have the measurement display annotations that indicate which portion of the waveform is being measured as well as reference levels for that measurement.

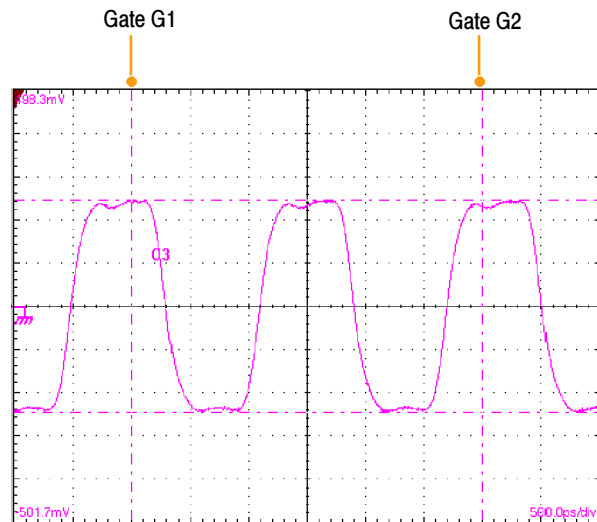
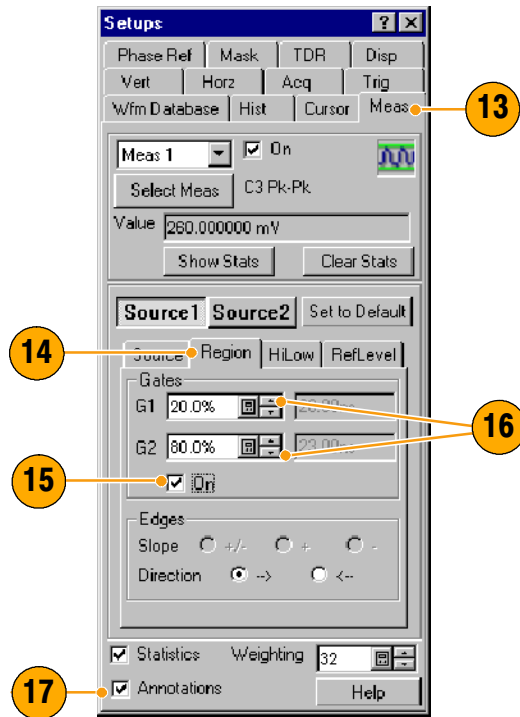

### Quick Tips

- If, at the time you first create a measurement, the measurement source you select is displayed as a waveform database, the database will automatically be measured. Deselect the **User Wfm Database** option if you want to measure the vector waveform instead of the database.
- Gate values are entered as a percentage of the waveform, displayed from left to right. If no keyboard is installed, access the virtual keyboard and use the touch screen to enter values.
- You can select and drag the gates to new locations by using a mouse or the touchscreen.

## Turning Off Automatic Measurements

Up to eight automatic measurements can be assigned. Once all eight slots are used, no more can be assigned. If you need to take another automatic measurement, and all measurement slots are used, make a slot available for the new measurement or redefine a current measurement slot.

1. Note the assigned measurements. Currently, measurement slots 1 and 3 have measurements assigned.

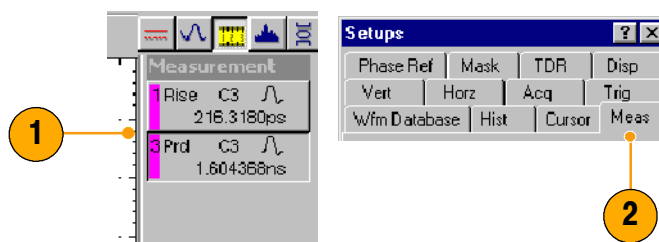

2. Select **Meas** (measurement) from the Setup dialog box.

3. Use the pulldown list to select **Meas 3** (measurement slot 3).

4. As indicated, measurement slot 3 has a measurement assigned and is displayed (On).

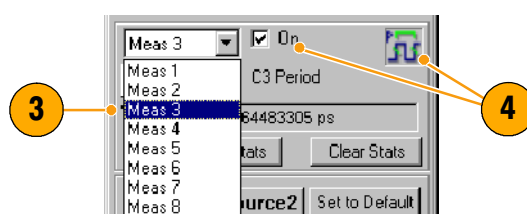

5. Press the **Select Meas** button to set the measurement slot 3 to **None**.

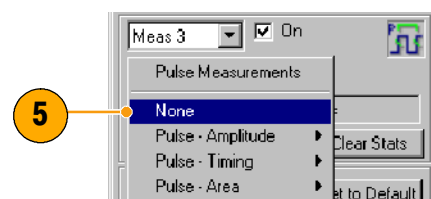

6. As indicated, measurement slot 3 is Not Defined and no measurement icon is displayed.

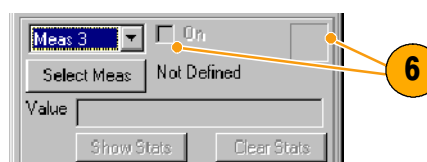

7. Here, measurement slot 1 has a measurement assigned. It is set to not display, but the measurement slot is still used.

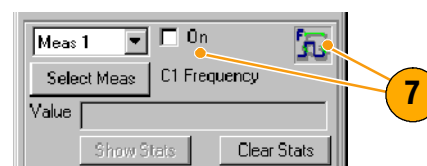

### Quick Tip

- To easily redefine a measurement slot, select **Select Meas** and choose a new measurement.

## Cursor Measurements

Use cursors to measure amplitude and time quickly and with more accuracy than when using the graticule to take measurements. Because you position cursors wherever you want on the waveform, they are easier to localize to a waveform segment or feature than automatic measurements.

1. Press the **CURSORS** button:

once for Vertical Bars

twice for Horizontal Bars

three times for waveform cursors.

Cursor selection is also available from the Setup menu.

2. Press the **SELECT** button to toggle selection between the two cursors. The active cursor is represented by a solid line.

3. Turn the General Purpose knob to position each cursor on the waveform to measure the feature that interests you.

4. Vertical bars (V Bars) measure horizontal parameters.

5. Horizontal bars (H Bars) measure amplitude parameters.

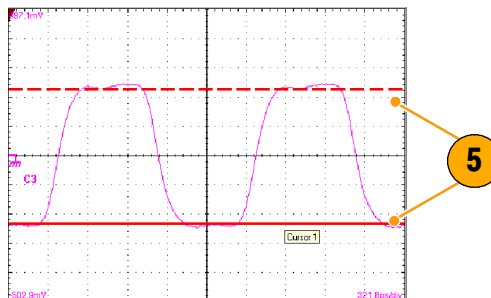
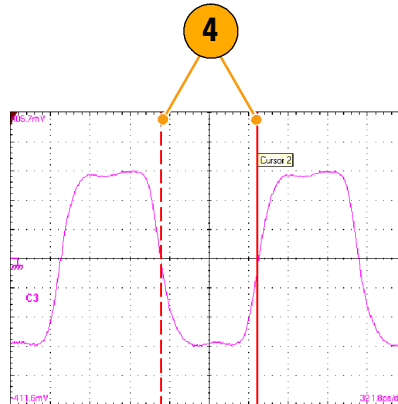
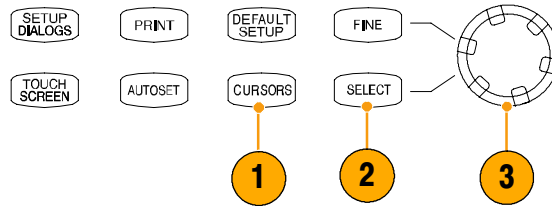

- Waveform cursors measure vertical and horizontal parameters simultaneously. Waveform cursors are attached to the waveform and track with the waveform points.

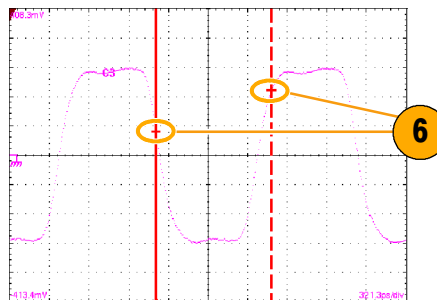

- Read cursor measurement results in the display.
- Click this button to toggle the cursor readouts on and off.

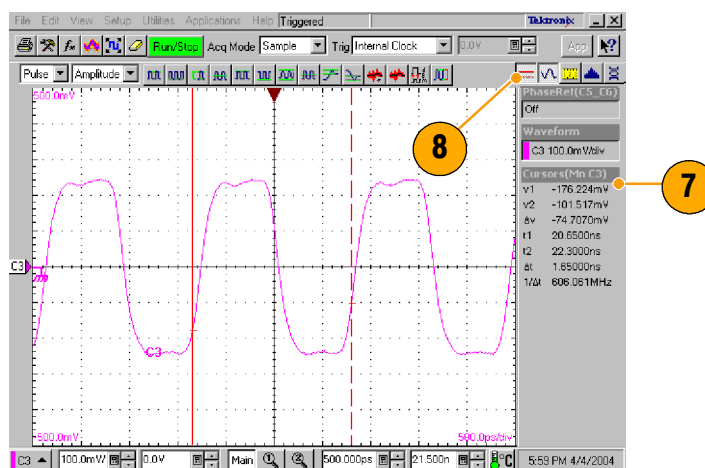

### Quick Tips

- Cursors require that at least one waveform is selected on screen.
- Waveform cursors are not available if a waveform database is selected.
- You can drag a cursor to place it relative to the waveform.
- You can assign each cursor to a different waveform to measure differences between waveforms. Make these selections in the Cursor setup dialog box.
- If you use two magnified time base views, you can take precision timing measurements between two distant points on a waveform. Magnify each point of interest in a separate time base, and then place one cursor on each point. The  $\Delta$ -time cursor readout will then reflect the position and resolution of the magnified time bases.

## Math Waveforms

You create math waveforms by creating a math expression using the Define Math dialog box. In that dialog box, you apply numerical constants, math operators, and functions to operands, which can be channels, waveforms, reference waveforms, measurements (scalars), or fixed scalars. You can display and manipulate these derived math waveforms much like you can the channel and reference waveforms.

1. Press the Vertical **MATH** button (once or twice if needed) to display the Define Math dialog box.

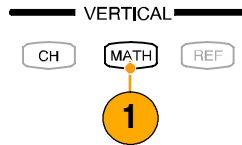

2. Click the **Math Waveform** drop-down list in the dialog box and select one of the eight available math waveforms.

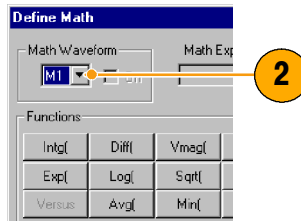

3. Use the dialog box to define a math expression. Some guidelines for creating your expression follow:
  - Sources (C1 - C8, R1 - R8, and Meas1 - Meas8) should be set up before you use them (references and automated measurement scalars should be defined).
  - Elements that appear grayed out cannot be selected because they would result in an illegal entry.

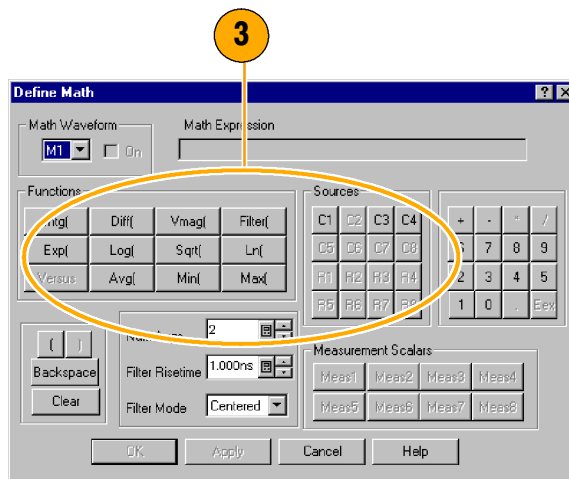

4. Use the filter controls in the dialog box to apply a filter to the math waveform defined by the expression.

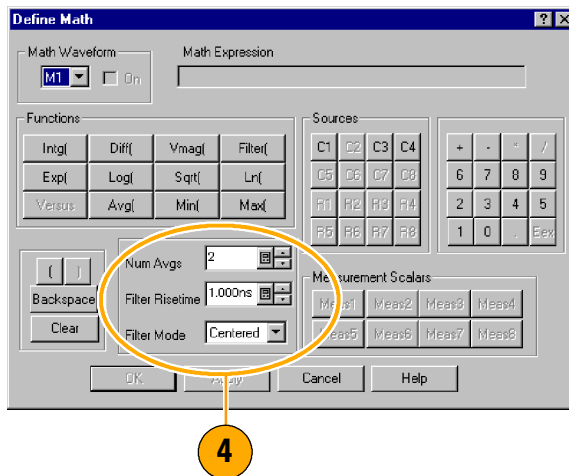

- When you have defined the expression, click **Apply**.
- Select the **On** box, so that the waveform displays.

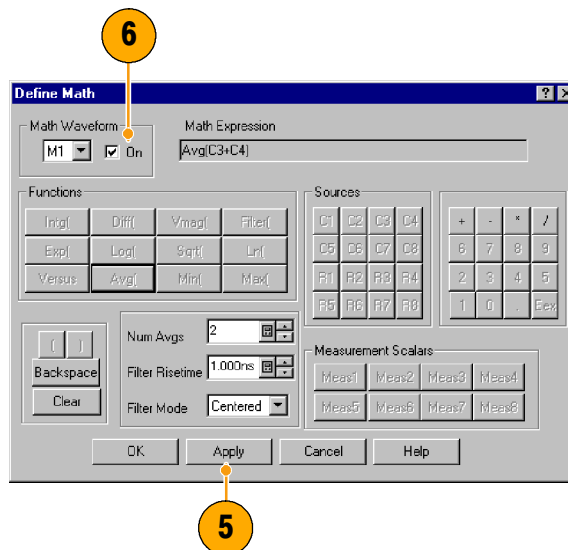

### Quick Tip

- If you select a waveform that is already defined, its math expression appears in the dialog box. To use the waveform, click the Clear button, which discards its previous math expression.

## Waveform Databases

The available four waveform databases can be used for measurements, histogram calculations, mask testing, and generating a density-style, graded display. Waveform databases may be automatically allocated for measurements, histograms, and mask testing.

1. Click **Wfm Database** in the Setup dialog box.
2. From the pulldown menu under Database, select one of the four available databases.
3. Click the **Source** button to select the waveform source.
4. Click **On** to start accumulating data from the selected source.
5. Click **Display** to turn on the display of the waveform database.
6. Select the Persistence mode for the selected waveform.
7. If you selected Variable persistence, you can specify the number of waveforms that are included in the waveform database.

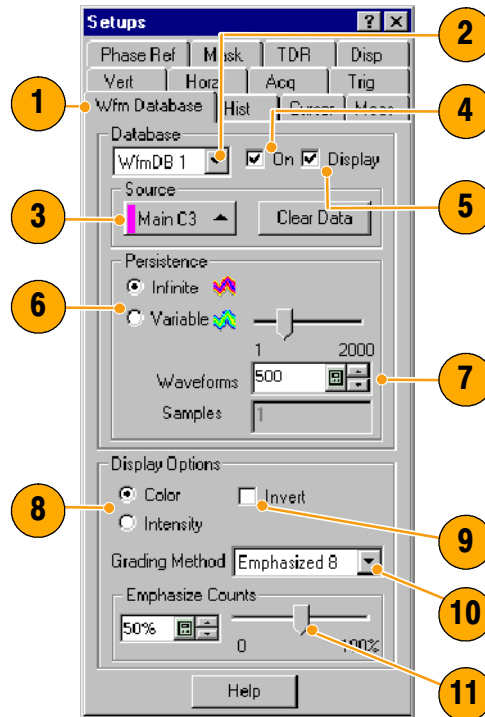

The following Display Options affect all waveform databases that you display:

8. Click a grading display option.
9. Click **Invert** to emphasize the least occurring pixels by reversing the intensity/color assignments to each grading partition.
10. Select one of the four grading methods.
11. If you selected one of the two Emphasized grading methods, slide the Emphasize Counts percentage control to specify the range of counts you want emphasized.

### Quick Tip

- Certain measurements require the use of a waveform database and automatically set the measurement system to use a waveform database if available.



## Display a Communication Signal

1. Carefully install the sampling module in the instrument. Refer to the procedure and cautions in *Installing Modules* on page 5. You should also read the user manual for your specific module.
2. Connect signals to your sampling module. *Always observe static-safe procedures and cautions as outlined in your sampling-module user manual* when connecting signals.

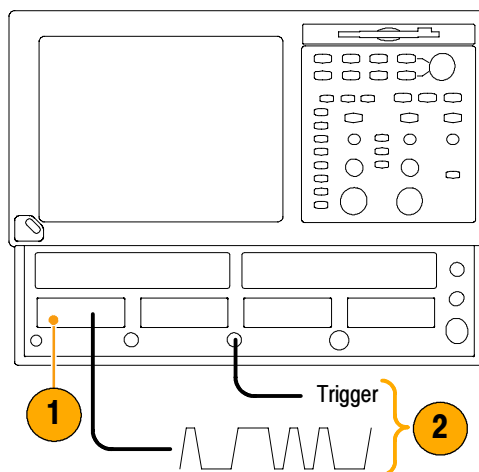

3. Select the channel that you want to display in the Mask setup dialog box.
4. Select the communication standard.
5. Click **Autoset** in the Mask setup dialog box or on the front panel.

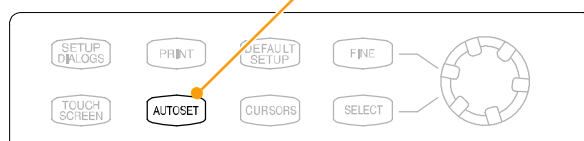
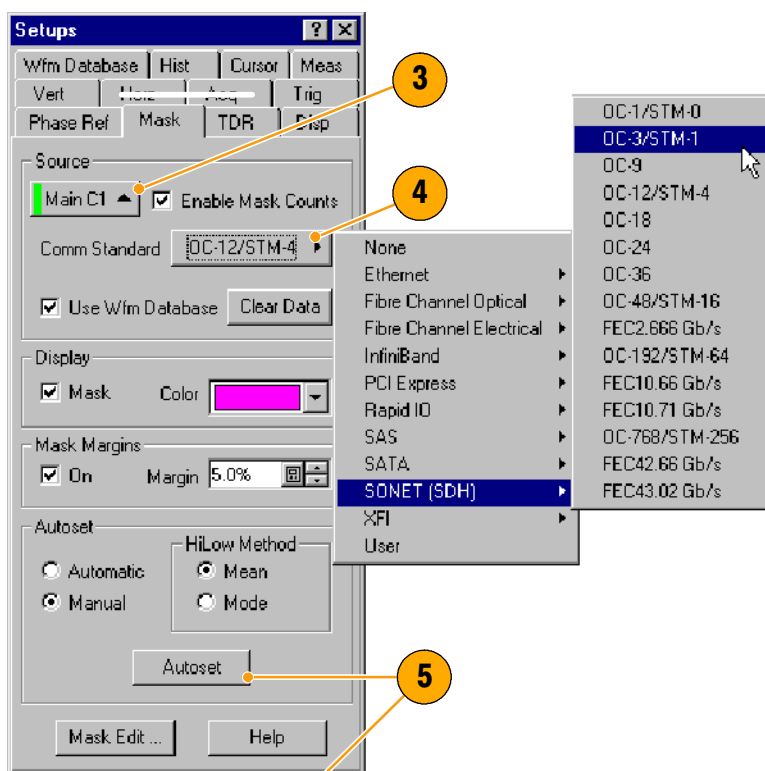

## Display and Analyze Communication Signals Using Mask Testing

Use mask testing to test your waveforms for time or amplitude violations against a predefined industry standard or a user-defined mask. Mask testing counts waveform samples (called hits or violations) that occur within a specific area (the mask). Use the communications-standard masks that this instrument provides (SONET/SDH, Fiber Channel Optical and Electrical, and Ethernet) to test your signals, or define your own masks.

1. Select the waveform to be mask tested from the drop-down list under Source.
2. Select a standard mask in the Mask setup dialog box. Selecting a communication standard or user-defined mask automatically:
  - Displays the mask on screen and autosets for the mask if Automatic is checked in the dialog box.
  - Enables mask testing.
  - Displays mask count statistics in the mask readout. A mask does not have to be displayed to have mask counting enabled.
3. If you want, disable mask counts. (Selecting a mask in step 2 automatically enabled them.)
4. Check **Use Wfm Database** to use a waveform database as the waveform source.
5. If you want, you can enable margins to explore design margins of your communications signal.

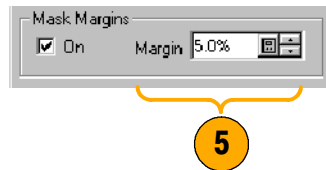
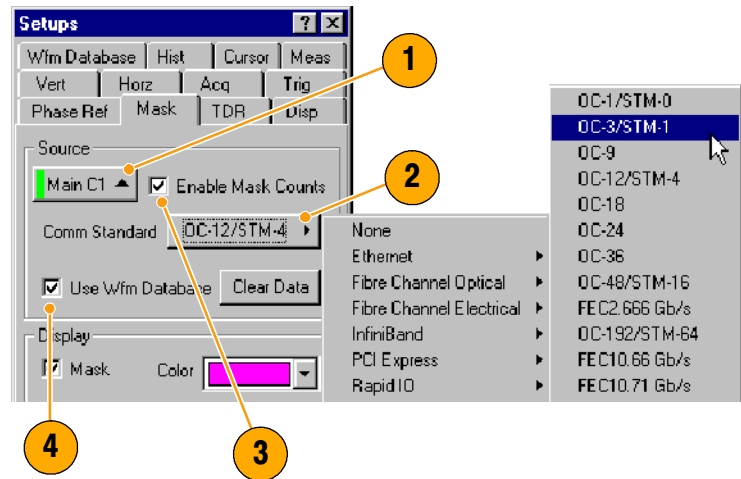

To autose the waveform to mask:

6. Click the Autoset button to perform a manual autose on the mask-source waveform.
7. Select the HiLow Method used to determine the High and Low values when aligning the input signal to the masks.

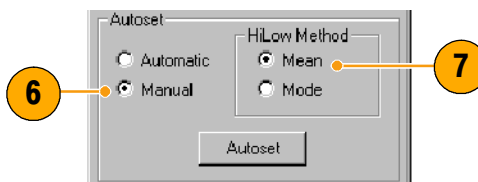

Mean sets the Mask Autoset to use the mean value of the High level (topline) and Low level (baseline), taken within the fixed eye aperture (center 20% of the eye), to align the input signal to the NRZ mask.

Mode sets the Mask Autoset to use the High level (topline) and Low level (baseline), taken across one unit interval of the eye diagram, to align the input signal to the NRZ mask.

To set a Stop Action:

8. Click **Acq** in the Setup menu.
9. In the Acq Setup dialog box, check the **Condition** option under **Stop After**.
10. In the Condition pulldown list, select a mask-related criteria, such as **Mask Total Hits** and set a count, such as 1, in the count box.

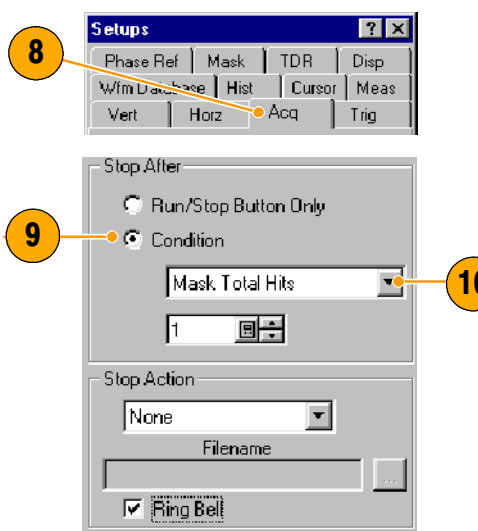

These settings stop acquisition when mask violations satisfy the criteria you set.

11. Push the **RUN/STOP** button to restart acquisition, if stopped.

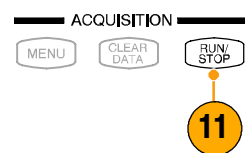

To restart testing:

12. To restart after a Stop After condition occurs, push the front-panel **CLEAR DATA** front-panel button.

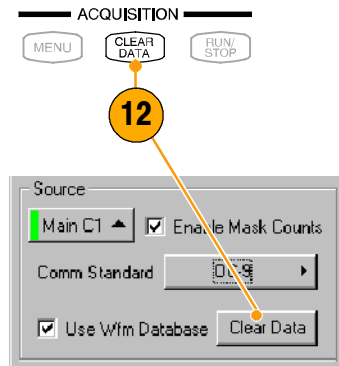

13. Read the mask-hits count in the readout.

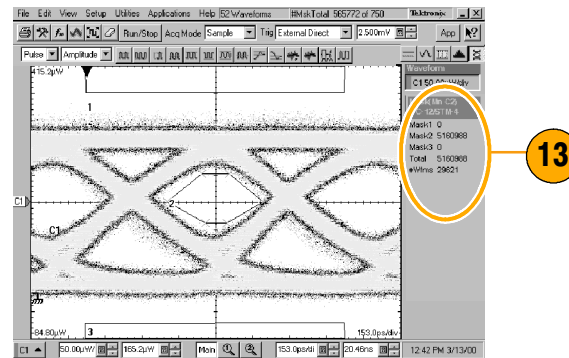

### Quick Tips

- Selecting a source that is currently displayed as a waveform database automatically enables mask testing on the database. To mask test the waveform instead of its database, deselect the **Use Wfm Database** box.
- You can choose to autoset the mask-source waveform to the mask each time you select a new mask standard by checking **Automatic** under Autoset.
- Pressing the **RUN/STOP** button after acquisition has stopped due to a Stop After condition being met causes the instrument to acquire one (and only one) additional waveform.
- The **Clear Data** button resets all mask counts. In addition, if the source for mask testing is a waveform database, clicking this button clears the waveform database.

## FrameScan®

Use FrameScan to test a specific bit (or range of bits) in a repeating frame of data. FrameScan acquisitions allow detailed display and analysis of individual, complete waveforms or of the bit sequences leading up to a failure. This ability to identify the specific patterns that caused the failures makes using FrameScan mode superior to traditional methods.

1. FrameScan is accessed from the Horizontal Setup menu.
2. Click **Enabled** in FrameScan.
3. Click **Auto Position**.
4. Set the **Start Bit** to specify the starting bit location for the scan when FrameScan Auto Position mode is on.
5. Set the **Scan Bits** to the number of bits or subframes you want to acquire.

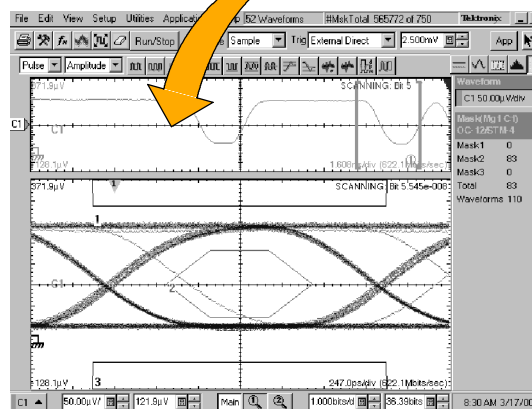
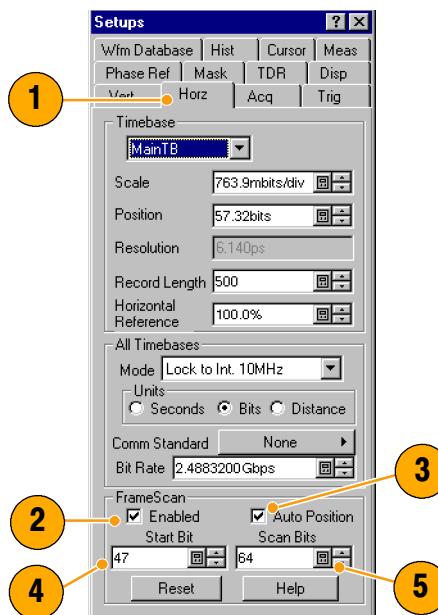

### Quick Tips

- The Start Bit control determines the starting horizontal position that FrameScan uses for each acquisition scanning cycle. The Auto Position control must be on to use the Start Bit.
- The Auto Position control is disabled when the Trigger Source is set to Pattern Sync. When using Pattern Sync, use the Relative Trigger Bit control in the Pattern Sync configuration settings.

## To Use TDR

To take TDR measurements, you must have a TDR-capable sampling module installed and your network must be attached to the TDR sampling module.

1. Select TDR from the Setup menu.
2. Click the **channel** button to automatically display the incident and reflected steps by automating the following tasks:
  - Turns on the channel.
  - Turns on a step.
  - Sets trigger source to Internal Clock.
  - Sets acquisition to Averaging.
  - Changes display style to Show Vectors.
3. Select a channel pair to perform a differential TDR measurement. Press the **Diff** button to automatically setup the differential measurement for the channel pair.

All the tasks listed in step 2 are performed for both channels and the pulse polarity of the second channel is set to negative.

4. Click the polarity button to toggle the step edge.
5. Set the vertical scale Units to V (volts),  $\Omega$  (ohms), or  $\rho$  (rho).
6. If performing differential TDR, select a channel pair for deskew adjustment from the pulldown list (even numbered channel gets adjusted).
7. Set the deskew percent value.
8. Select an internal clock rate from the drop-down list. The instrument will generate TDR pulses at this rate.

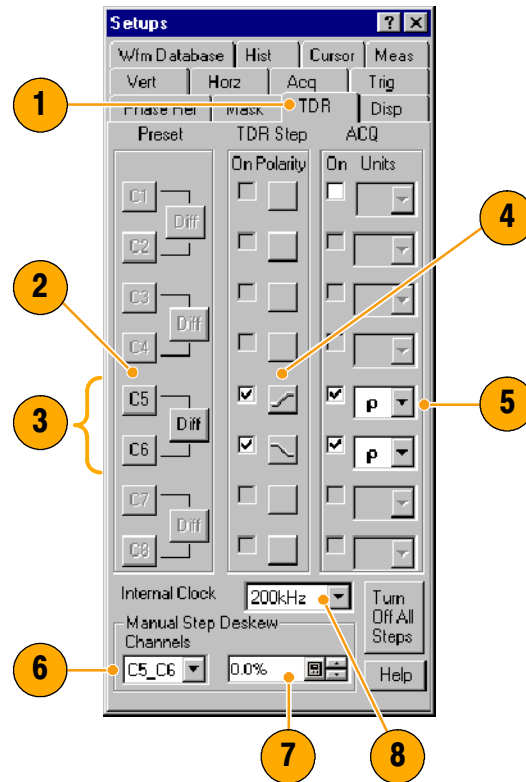

### Quick Tip

- Use a lower clock rate to examine long cables.

## Phase Reference

Use the Phase Reference Module, and the phase-correction timebase that it supports, when you need to acquire with ultra low jitter. When you use this mode, you reduce trigger jitter in the instrument, which lets you measure clock and other phase jitter vulnerable signals with more fidelity.

To use phase reference, you must have a Phase Reference module (such as the 82A04) installed in one of the compartments and a phase reference clock signal synchronous to the data to be acquired connected to the Phase Reference module. Refer to the On-line Help for more information on using the Phase Reference timebase.

1. Click **Phase Reference** in the Setup menu to display the Phase Reference dialog box.
2. Turn **Phase Correction** on by checking either **Free Run** or **Triggered**.
  - Free Run: A trigger is automatically generated. Multi-clock-cycle-period displayed signals are synchronous with the phase reference but overlaid.
  - Triggered: Samples are corrected for horizontal position per the phase reference supplied, but otherwise have all the attributes of a triggered waveform.
3. Click the **Source** control to select the module to which you connected the clock (if more than one phase reference module is installed).
4. Select the input frequency to the phase reference module.
  - Use the **Input Freq** control to enter the frequency of Phase Reference clock or use the **Standard Freq Table** button to select a communications standard appropriate for the Phase Reference clock.
5. Press the **Characterize** button to characterize the clock signal attached to the phase reference module.

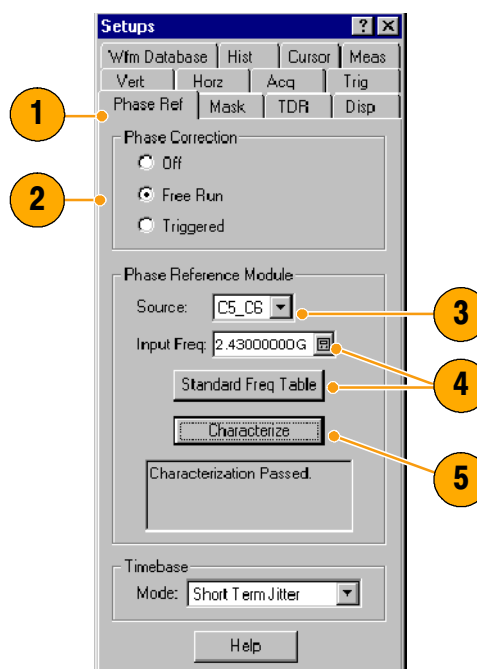

### Quick Tip

- When entering the phase reference clock frequency, the value must be within 1% of the actual frequency.

## Histograms

The instrument can display histograms constructed of waveform data. You can display both vertical (amplitude) and horizontal (time or distance) histograms, but only one at a time.

1. Display the Hist (Histogram) dialog box.
2. Check the **Enable Histogram** box.
3. Click the **Source** button to select the waveform source.
4. Select a vertical or horizontal histogram.

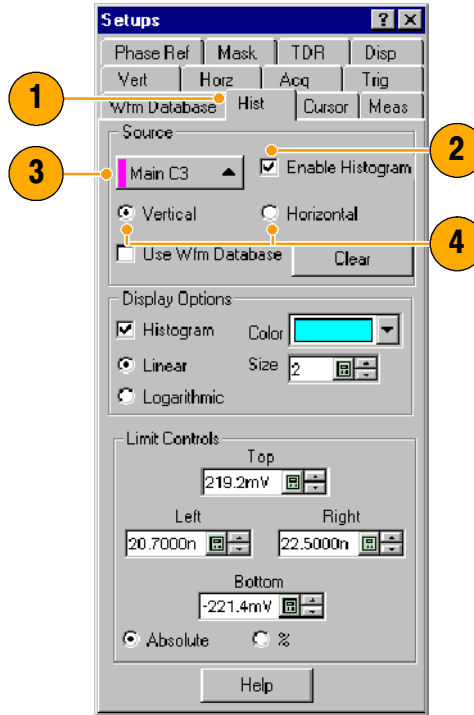

5. Click and drag the edges of the histogram box to enclose a portion of the waveform.
6. The histogram displays at the edge of the graticule. The histogram statistics are displayed in the readout.

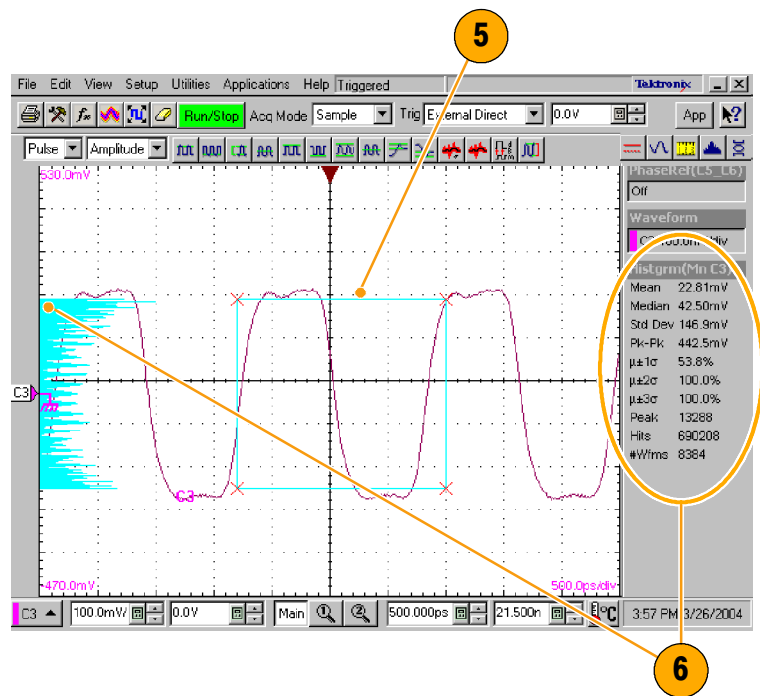





## Using the 80A05 Electrical Clock Recovery Module Examples

This section contains various ways to use an 80A05 Electrical Clock Recovery module with other optical and electrical sampling modules.

The 80A05 brings a new standard for ease of use to sampling oscilloscopes: simple triggering on electrical signals through its clock recovery on either single-ended or differential signals. The differential functionality, in particular, simplifies acquisitions that were previously difficult to accomplish. The 80A05 is able to recover clock signals at most standard rates between 50 Mb/s and 12.6 Gb/s.

The skew between signals presents a challenge to many measurements. Verifying the amount of skew, and deskewing when necessary keeps your skew errors in check and limits the undesirable influence of common mode signal on your measurements.

This section presents simple example setups and information about vertical calibration, horizontal deskew, and minimizing the effect of skew on your measurements.

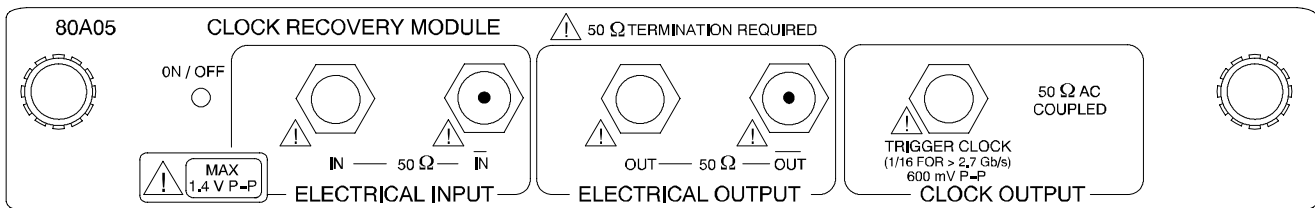
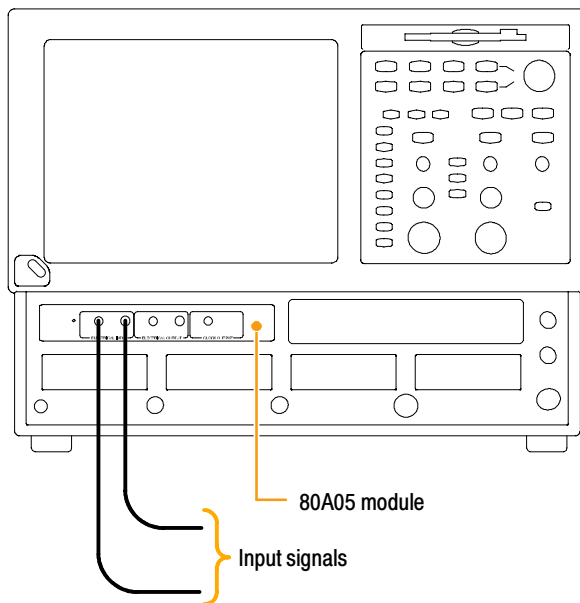

Figure 1: 80A05 module

## Clock Recovery / Trigger on Recovered Clock

In this example, the signal is simply connected to the 80A05 module. The 80A05 delivers a recovered clock signal to the mainframe to be used for triggering by setting the trigger source to Clock Recovery for the channel the 80A05 occupies. Differential signals might need to be deskewed as described in the *Skew and Deskewing* section on page 63. The signal outputs of the 80A05 are unused (capped with their 50  $\Omega$  terminations) in this example.

The connections for acquired signal(s) are not shown in the illustration.



**Figure 2: Clock recovery / trigger with the 80A05 module setup example**

## Clock Recovery / Trigger for Optical Signal, with the 80C12 Optical Module

In this example, the single-ended, electrical (split) signal from the 80C12 module's Electrical Signal Out is connected to the 80A05 module's Electrical Signal In. The 80A05 delivers the recovered clock signal from the 80C12 to the mainframe to be used for triggering by setting the trigger source to Clock Recovery for the channel the 80A05 occupies. The signal outputs of the 80A05 are unused (capped with their 50  $\Omega$  terminations) in this example.

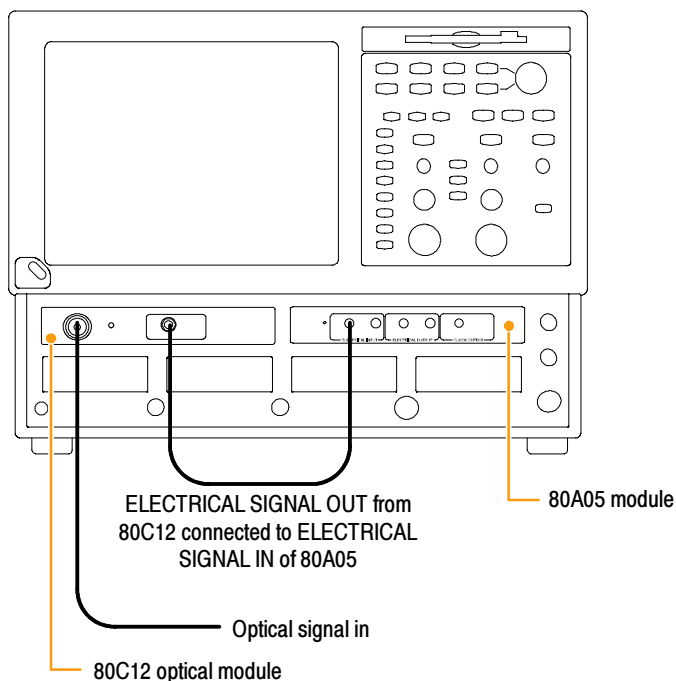

**Figure 3: Clock recovery / trigger with the 80C12 and 80A05 modules setup example**

## Differential Clock Recovery and Acquisition

In this example, the 80A05 module's *Electrical Output* signals are connected to an electrical sampling module(s), such as an 80E03, with a set of differential cables. A matched set of coaxial cables is recommended for both the connection between modules and the connection to the DUT.

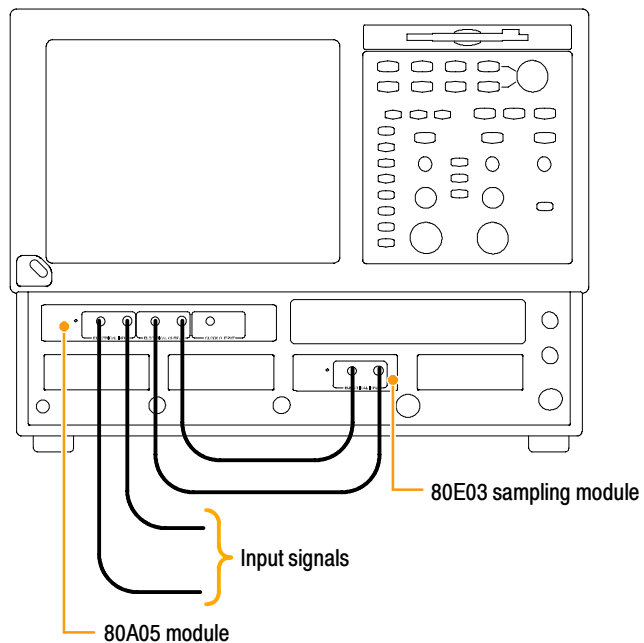

**Figure 4: Differential clock recovery and acquisition setup example**

## Probing with Low-impedance Probes

Low Capacitance Probes (also called Z0 Probes or Controlled Impedance Probes) are passive probes that have very low input capacitance. These probes are a useful choice for some applications. However, because the input resistance on these probes is also low, they can cause measurement errors.

Passive probes, such as the P6150 (with 10X probe tip) and the P8018 Handheld TDR Probe, when used with with good quality cables, can typically probe systems approaching 20 GHz. In particular, the bandwidth of the P6150 is greatly improved by using a very short, high speed cable.

When debugging or characterizing a functioning circuit, a controlled-impedance probe will drain current from the DUT. When the in-circuit source impedance is not small compared to the probe impedance (typically  $500\ \Omega$  for 10X), this current can be appreciable and impact important parameters such as bias point, offset voltage, noise margin, signal amplitude, switching point. In this case, the probe introduces errors in the measurements it is being used to take. The probe can change the behavior and can even cause the circuit to stop working.

When using differential probes, you should use a matched set of coaxial cables.



**Figure 5: P6150 Probe**

## Probing with Differential to Single-ended Probes

The popular P7380 series TekConnect® probes can be used with 80A03 TekConnect adaptor. The P7380 offers two outputs – one on the TekConnect connector, and another on an SMA on the probe body. If the signal captured by the probe is to be used for both clock recovery and acquisition, we recommend using the signal from the SMA on the probe body for the clock recovery task. Connect the probe body SMA to the 80A05 input. The acquisition path uses the TekConnect signal.

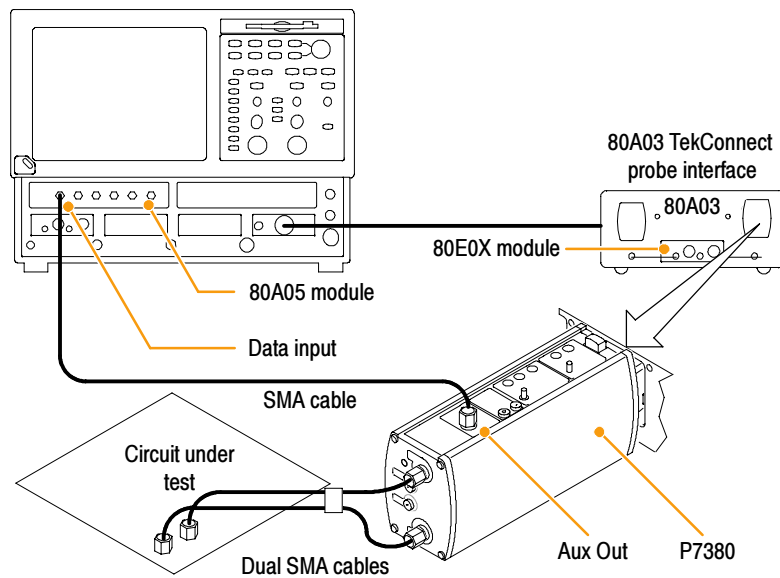

**Figure 6: Differential to single-ended probes setup example**

## Vertical Gain Adjustment

If the signal is passing through the Input of the 80A05 module, it might be necessary to adjust the signal for accurate Vertical Scale. Since the TDS8200 and CSA8200 mainframes have a built-in calibration voltage, this is a simple procedure.

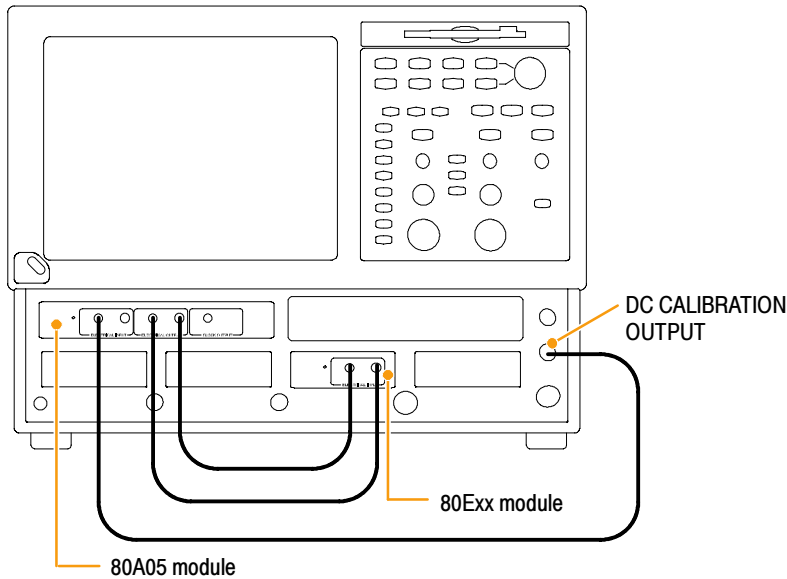

**Figure 7: Vertical Gain Adjustment; 1<sup>st</sup> of two channels shown**

After the connections are made, select the *Setup > Vert* menu, set the *DC CAL* calibration voltage to an appropriate value and adjust the value in the *External Attenuation* window to achieve the proper voltage reading (as measured with a Pulse Mean measurement).

---

**NOTE.** The output impedance of the DC CALIBRATOR OUTPUT is close to  $0 \Omega$ .

---

If this is a differential setup, repeat for both inputs.

This procedure applies equally well if a probe is connected to the input of the 80A05 module. For example, both the P6150 and the P6380 probes can be calibrated using this *DC CAL* voltage.



## Skew and Deskewing

The differential amplitude of the signal is significantly dependent on the skew between the signals. It is readily apparent that a skew of  $180^\circ$  (half a period) would change the amplitude of a balanced differential signal to 0.

At high speeds, this situation is a realistic problem; for example, a 10 GHz signal has a half-period of 50 ps, resulting in an unacceptable amplitude error from skew of 25 ps on one cable and  $-25$  ps on the other.

In the time domain, differential skew of a step signal will become clearly visible as a step in the mid-rise when the skew between the differential branches is on the order of the risetime of the signal observed. See Figure 8 for an example of how skew between branches of the differential signal impact the signal and its risetime.

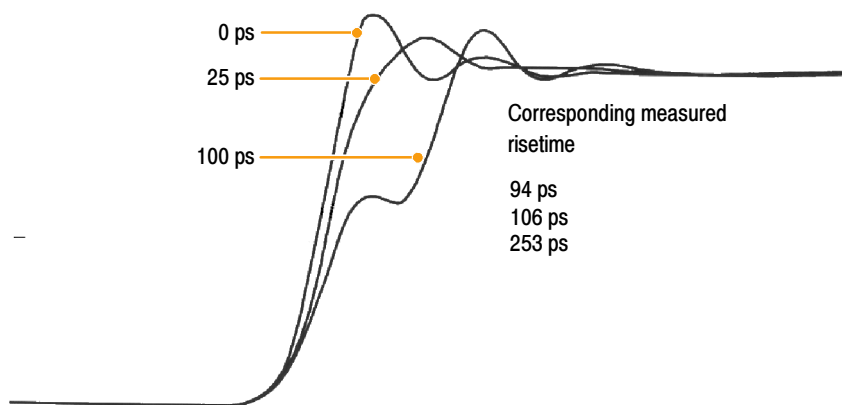

**Figure 8: 90 ps differential step captured with different skews**

Another reason for deskew is to fully suppress the common mode signals. Not every differential acquisition is measured in the presence of significant common mode signal, but those that are, typically do need to suppress the common mode signal as much as possible; this can be done only if the differential acquisition is well deskewed.

## Minimizing Skew

You can minimize skew between differential branches by following these simple rules:

- Use balanced cable pairs.
- Measure and match your cables (a single TDR module, the 80E04, allows you to measure cable delays with very high precision).
- Use Differential probes or Differential SMA to Single-ended active convertors such as the Tektronix P7380SMA.

If the skew cannot be removed, or is unknown, proceed with measuring and/or removing it.

## Measuring Skew

In most situations, you can determine the skew by measuring the horizontal position of the signals under consideration (the skew is the difference between threshold crossing times).

- For single valued waveforms (as opposed to eye diagrams), you can use averaging and/or filtering. The filter is found in the math menu; its time constant (“Filter Risetime”) should be set to a fraction of the measured signal’s risetime. Also keep in mind that the filter requires a pre-charge, so the signal trace is unreliable from the edge of the screen one time-constant inward (on both the left and on the right edge of the screen).

The position of the waveform can be read with either the cursors or the automatic measurement. Saving the first signal as a reference is a convenient way to keep it available and visible.

- For multi-valued waveforms (eye diagrams) neither average nor filter is appropriate; rely instead on the automatic measurement system to find the precise position of the crossing.

## Methods to Deskew Your Signals

For best measurement results, you need to deskew your connection before every target (input). If you are using the 80A05 module to recover clock from a differential signal, you need to deskew at the SMA connectors connected to the 80A05. If you are also viewing the signals out of the 80A05 module, for best results, you need to deskew again, this time from the 80A05 module to the sampling module(s) inputs. This is shown in Figure 9.

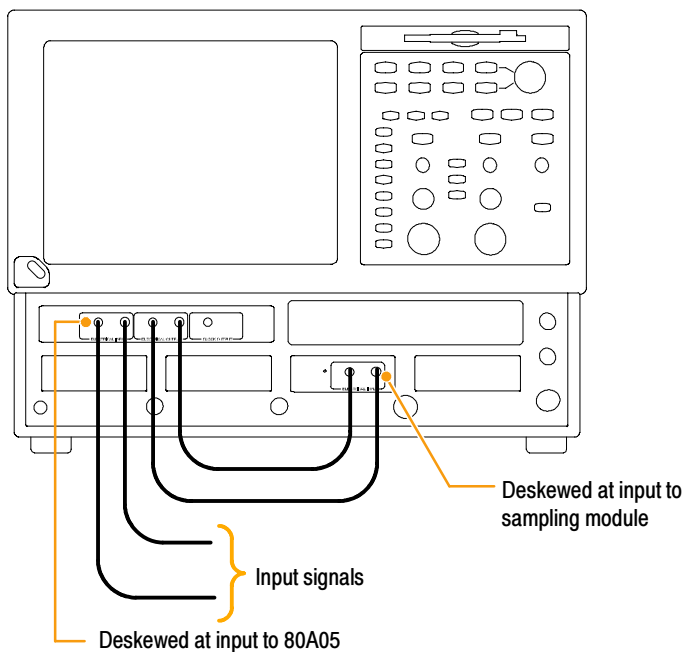

**Figure 9: Deskewing singles with multiple input path**

In cases where there is an insignificant amount of common mode signal between the differential branches, this might be all the deskew you need – you might not need to deskew to the 80A05 module inputs. Keep in mind that depending on the bit rate, the accuracy required, and your cabling, you might not need all of the deskewing steps.

Here are some practical examples of deskewing your signals in different situations:

### Trigger Present, Known Fast-edge Signal Present

If there is a trigger signal that you can rely on while you are deskewing your differential signal, and there is a known, fast-edge that is (or can be) connected to your DUT, deskew with this signal. If the target is an 80A05 module (and as such has no acquisition of its own), use any single acquisition channel (available in your setup) to measure the horizontal position of first one, then the other branch of the differential signal (bypassing the 80A05 module for the moment). For example, you have channel 1 of an 80E02 module available for acquisitions; connect the +branch of the electrical signal to ch1, note the position (you can save it as a reference waveform); disconnect the +branch from the ch1 (and terminate it properly), connect the – branch to ch1 and adjust your deskew adjustment to remove the skew. (Refer to *Methods to Adjust Out Skew* on page 66).

### No Trigger – Zero Skew Signal Available

Use the *INTERNAL CLOCK OUTPUT* signal on the oscilloscope as the signal source (into your differential probe or circuit) – first for one branch, then for the other. Set the oscilloscope trigger source (Trigger setup menu) to *Internal Clock*. Setting the trigger source to Internal Clock also enables the *INTERNAL CLOCK OUTPUT* connector.

Supposing that you have a channel 1 available for acquisitions; connect the oscilloscope end of the +branch of the cabling/fixture you are deskewing to ch1, and the DUT end of the +branch of the cable to the *INTERNAL CLOCK OUTPUT* signal on the oscilloscope. Note the position of the signal (e.g. save as a reference waveform).

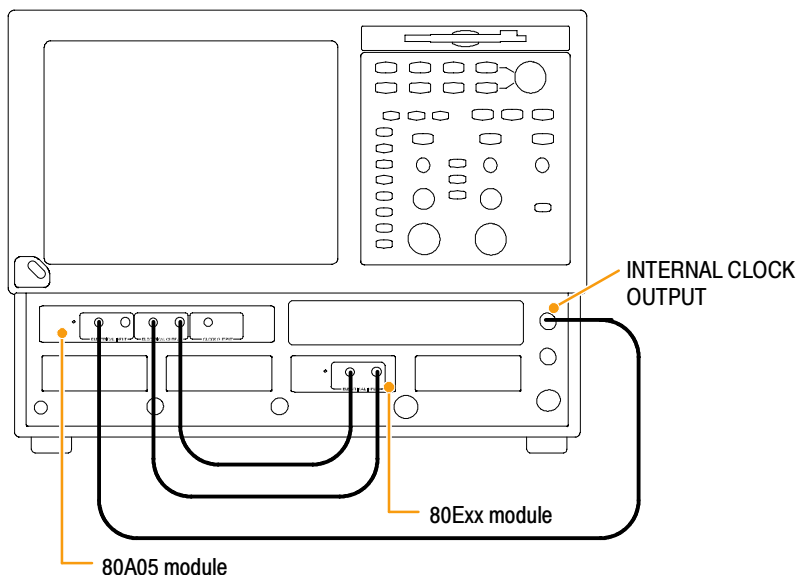

**Figure 10: Deskewing with INTERNAL CLOCK OUTPUT**

With the +branch done, disconnect the +branch from the ch1 (and terminate it properly). Now do the deskew measurement for the – branch the same way as for the +branch. Then adjust the fixture to remove the skew. (Refer to *Methods to Adjust Out Skew* on page 66).

## Methods to Adjust Out Skew

### Using a Phase Adjuster

Skew can be adjusted out with the use of a variable delay line (Phase Adjuster). Tektronix part number 015-0708-00 is a Phase Adjuster with a 25 ps range and VSWR of 1.3:1 at 18 GHz.

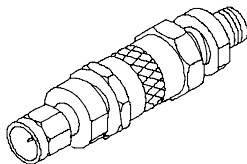

The advantage of a Phase Adjuster is that it is functionally invisible. After adjusting, the signals are fully available for analysis as if they never needed deskewing.

The disadvantage is the signal fidelity is slightly impacted.

### Deskew with the Acquisition System

- **Repetitive Signal:** This method relies on the fact that your signals are completely repetitive relative to the trigger of your sampling oscilloscope. If, for each trigger, there is always the same signal (for example, always bit 4 of a PRBS7 signal), the oscilloscope can adjust the skew in a simple way where first the data is captured with the timebase skew adjusted for one channel, then for the second channel. Most equipment can handle this method of deskew. The number of triggers needed to fill the trace doubles relative to an un-deskewed acquisition system.
- **Random Signal:** Random signals are signals that don't necessarily repeat on equivalent trigger events from acquisition-to-acquisition. One example would be acquiring a random or pseudo-random serial data bit stream (for example, a PRBS7 signal) while triggering directly on its associated serial clock (or from the data stream's recovered clock).

In the case of random signals, the oscilloscope must acquire each waveform sample of both differential branches from exactly the same trigger event. Otherwise, due to the signal's random nature, one of the samples of the differential pair may have changed value (from an absolute, real-time perspective) and yield incorrect results when viewing the mathematical differential or common mode waveform.

To ensure that random, differential or common mode signals can be properly time aligned, the TDS8200 and CSA8200 oscilloscopes allow the skew to be adjusted between individual modules by way of independent acquisition timebases. While the skew can also be adjusted between the individual channels of a dual-channel module, doing so causes the channels to be acquired on separate trigger events (as described above for repetitive signals) and thus is not suited for viewing the differential or common mode mathematical waveforms.

Most sampling oscilloscopes cannot offer acquisition system deskew for random signals. With the TDS8200 and CSA8200 oscilloscopes, the skew can be adjusted between two independent modules. This is because each module has its own timebase. Conversely, the two channels of the 80E02, 80E03, and 80E04 modules cannot be deskewed in this sense.

## Cleaning the Instrument

Periodically you may need to clean the exterior of your instrument. To do so, follow the instructions in this section.



---

**WARNING.** Before performing any procedure that follows, power down the instrument and disconnect it from line voltage.

---

### Exterior Cleaning



---

**CAUTION.** To prevent getting moisture inside the instrument during external cleaning, use only enough liquid to dampen the cloth or applicator.

---

Clean the exterior surfaces of the chassis with a dry lint-free cloth or a soft-bristle brush. If any dirt remains, use a cloth or swab dipped in a 75% isopropyl alcohol solution. Use a swab to clean narrow spaces around controls and connectors. Do not use abrasive compounds on any part of the chassis that may damage the chassis.



---

**CAUTION.** Avoid the use of chemical cleaning agents which might damage the plastics used in this instrument. Use a 75% isopropyl alcohol solution as a cleaner and wipe with a clean cloth dampened with deionized water. (Use only deionized water when cleaning the menu buttons or front-panel buttons.) Before using any other type of cleaner, consult your Tektronix Service Center or representative.

---

### Flat Panel Display Cleaning

The instrument display is a soft plastic display and must be treated with care during cleaning.



---

**CAUTION.** Improper cleaning agents or methods can damage the flat panel display. Avoid using abrasive cleaners or commercial glass cleaners to clean the display surface. Avoid spraying liquids directly on the display surface. Avoid scrubbing the display with excessive force.

---

Clean the flat panel display surface by gently rubbing the display with a clean-room wipe (such as Wypall Medium Duty Wipes, #05701, available from Kimberly-Clark Corporation).

If the display is very dirty, moisten the wipe with distilled water or a 75% isopropyl alcohol solution and gently rub the display surface. Avoid using excess force or you may damage the plastic display surface.

### Optical Connector Cleaning

When using optical modules, the measurement accuracy is increased (or maintained) by keeping the optical connectors clean. It's important to follow the procedures for cleaning optical connectors provided in the optical module user manual.



# Index

## A

- Accessories, 3
- Acquisition, set Stop mode & action, 28
- Acquisition modes, how to set, 28
- Annotations, 40
  - show, 38
- Auto, trigger mode, 30
- Automatic measurements, how to
  - localize (gates), 40
- Autoset, 26

## C

- Calibration, 20
- Characterize, phase correction, 53
- Cleaning, instrument, how to, 67
- Cleaning and inspection
  - exterior, 67
    - flat panel display, 67
- Cleaning optical connectors, 67
- Clock recovery, trigger source, 31
- Communication, signal, 47
  - mask testing, 48
- Compensation, 20
  - how to perform, 20
- Connectors
  - EXTERNAL DIRECT, 31
  - EXTERNAL PRESCALE, 31
  - trigger, 31
- Control panel, 12
- Control panel map, 14
- Controls bar, 13
- Cursor measurements, 42

## D

- Dark-level compensation, how to perform, 22
- Default setup, 26
- Setup boxes, 27
- Diagnostics, 18
- Display
  - map - main & mag views, 15
  - map - main view, 15
  - style, 29
  - waveform, 13
- Display map, 15
- Document results, 55
- Documentation, v
- Dots, displaying waveform record points
  - as, 29
- Dual monitor, 8

## E

- Emergency Startup disk, 7
- Enable histogram, 54
- Statistics, histogram, 54
- Export, waveform, 55
- Extended desktop, 8

## F

- Flat panel display, cleaning, 67
- Frame, trigger, 31
- Frame Scan, 51
- Front panel, connectors, 12

## G

- Gated trigger, 32
- Graticule
  - color, 29
  - style, 29

## H

- H Bars cursor, 42
- High frequency triggering, 32
- Histogram
  - enable, 54
  - statistics, 54
- Histograms, 54
- Holdoff, triggering, 32
- Horizontal, set up procedure, 24

## I

- Incoming inspection, 18
- Indicator
  - compensation, 13
  - phase reference status, 13
- Infinite persistence, 29
- Input frequency, phase correction, 53
- Inspection and cleaning
  - exterior, 67
    - flat panel display, 67
- Instrument, cleaning, 67
- Interface map, 13

## K

- Knob, trigger main LEVEL, 30

## L

- Language, change, 10
- Level, trigger, 30
- Linear interpolation, 29

## M

- Map, waveform display, 15
- Mask testing, 48
  - autoset to a mask, 49
  - stopping acquisition based on, 49
- Math
  - editor, 44
  - waveform, 44
- Measurement accuracy, optimizing, 20
- Measurements, 37
  - cursor, 42
  - how to localize (gates), 40
  - turning off, 41
- Measurements bar, 13
- Menu bar, 13
- Metastability reject triggering, 32
- Mode, trigger, 30

## N

- Normal, trigger mode, 30

## O

- Online help, 16
  - displaying control descriptions, 16
  - displaying overviews, 17
  - using the finder, 17
- Operating specifications, 4

## P

- Pattern Sync, trigger source, 31
- Phase correction, 53
  - characterize, 53
  - input frequency, 53
- Phase reference, 53
- Power supply, 4
- Print, 55

## Procedure

- To compensate the instrument and modules, 20
- To localize a measurement, 40
- To perform dark-level and user wavelength gain compensations, 22
- to set acquisition modes, 28
- to set up the signal input, 24

**R**

- Readout display, 13
- Readouts, 13
- Readouts bar, 13
- Rear panel, connectors, 12
- Recovery disk, 7
- Related documentation, v

**S**

- Save
  - setup, 55
  - waveform, 55
- Serial mask testing, 48
- Setup, save, 55
- Signal, communication, 47
- Sin(x)/x interpolation, 29
- Single sequence, 28
- Slope, trigger, 30
- Sources, trigger, 30
- Specifications
  - operating, 4
  - power supply, 4

- Start an acquisition, 28
- Status bar, 13
- Stop an acquisition, 28

**T**

- TDR, 52
- Temperature compensation, 20
- Tool bar, 13
- Trigger
  - clock recovery source, 31
  - concepts, 30–33
  - connector, 31
  - event, 30
  - EXTERNAL DIRECT connector, 31
  - EXTERNAL PRESCALE connector, 31
  - frame, 31
  - level, 30
  - modes, 30
  - pattern sync, 31
  - slope, 30
  - sources, 30
  - type, 30
- Trigger inputs, usage limitations, 32
- Trigger MAIN LEVEL knob, 30
- Trigger source, usage limitations, 32
- Triggering
  - based on application, 31
  - edge, 30–36
  - gated, 32
  - high frequency, 32
  - holdoff, 32
  - metastability reject, 32

**U**

- User interface
  - compensation indicator, 13
  - controls bar, 13
  - measurements bar, 13
  - menu bar, 13
  - phase reference status, 13
  - readouts bar, 13
  - readouts display, 13
  - status bar, 13
  - tool bar, 13
  - waveform bar, 13
- User wavelength compensation, how to perform, 22

**V**

- V Bars cursor, 42
- Variable persistence, 29
- Vectors, displaying waveforms as, 29
- Vertical, set up procedure, 24
- View, main & mag, 15

**W**

- Waveform
  - display, 13
  - export, 55
  - save, 55
- Waveform , display style, 29
- Waveform bar, 13
- Waveform cursors, 42, 43