



FlappyBird



PLACE SERIAL NUMBER LABEL HERE



TABLE OF CONTENTS

FACTORY CONTACT INFORMATION	2
WELCOME TO: Flappy Bird	4
HOW TO PLAY	5
SPECIFICATIONS	6
SAFETY PRECAUTIONS	6
QUICK SET UP GUIDE	7
MAIN MENU FUNCTIONS	8
GAME SETTINGS	9
REDEMPTION GAME PAYOUT	10-13
MERCHANDISER PAYOUT MENU	14
ENTERTAINMENT ONLY PAYOUT MENU	14
DATE/TIME MENU	15
STATISTICS	16
DIAGNOSTICS	16
WIRING DIAGRAMS	17-19
TROUBLESHOOTING GUIDE	20-25
ON-SCREEN ERROR CODES	26
HOW TO: REMOVE PLAYER BUTTON	27
HOW TO: REPLACE POWER STRIP	27
POWER SUPPLY DIAGNOSTICS	28
BILL ACCEPTOR DIAGNOSTICS	29
CARD SWIPE INSTALLATION	30
2300 BOARD PINOUT GUIDE	31
PARTS LIST	32
PARTS IDENTIFICATION	33-34
DECAL PLACEMENT DIAGRAM	35
MAINTENANCE LOG	35
TECHNICAL SUPPORT	36
WARRANTY	37

WELCOME TO: FLAPPY BIRD

Congratulations on your purchase!

Join the app game craze with the ultra-popular Flappy Bird! Quick, simple and completely addictive, Flappy Bird will have your customers lining up for high score!

Please take a moment to read through this manual and be sure to contact our factory if you have any questions, or would like some more information.

Thank you for your purchase! Your business is important to us and we hope you enjoy this game as much as we do!

Your Friends at Bay Tek Games

FlappyBird



GAME INSPECTION

Inspect the game for any damaged, loose, or missing parts.

If damage is found, please contact your freight carrier first.

Then, contact Bay Tek Games' Service Department at 920.822.3951 or e-mail them at service@baytekgames.com for further assistance.

HOW TO PLAY

Tap the button to make the bird fly.



Get tickets for every set of pipes you pass through.

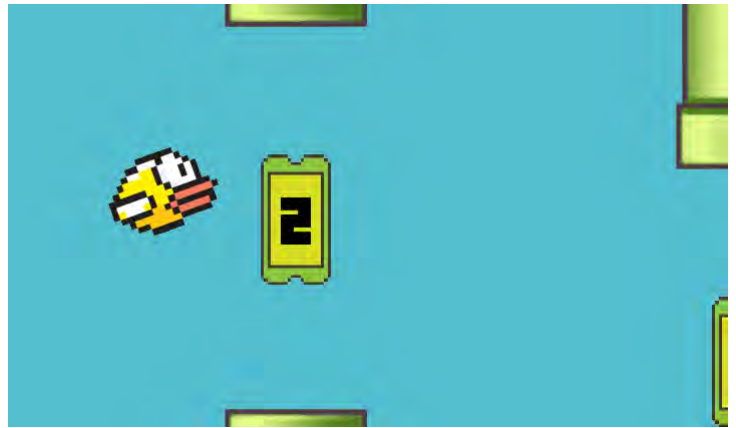

Don't crash into the pipes or your game is over!

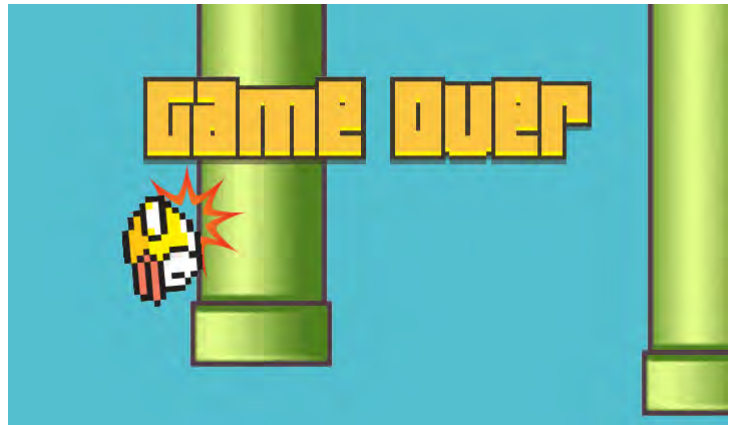

Play again and try to get the high score!















GAME SPECIFICATIONS

WEIGHT	
NET WEIGHT	300 LBS
SHIP WEIGHT	370 LBS
DIMENSIONS	
WIDTH	37"
DEPTH	45"
HEIGHT	91"
OPERATING TEMPERATURE	
FAHRENHEIT	80-100
CELSIUS	26.7-37.8

POWER REQUIREMENTS			
INPUT VOLTAGE RANGE	100 to 120 VAC	/	220 to 240 VAC
INPUT FREQUENCY RANGE	50 HZ	/	60 HZ

MAX START UP CURRENT	OPERATING CURRENT
1.5 AMPS @ 115 VAC	0.75 AMPS @ 115 VAC
1.8 AMPS @ 230 VAC	0.9 AMPS @ 230 VAC

SAFETY PRECAUTIONS

 NOTICE 
Modifications to the mechanical, electrical and structural components of this game may void its compliance certifications.
 DANGER 
DO NOT perform repairs or maintenance on this game with the power ON. Unplug the unit from the wall outlet or shut off the power strip located inside the cabinet.
 WARNING 
Use of flammable substances can cause sever burns or serious injury. Always use NON-FLAMMABLE solvents for cleaning. DO NOT use gasoline kerosene or thinners.
 CAUTION 
Lifting heavy objects can cause back, neck or other injuries. Be sure adequate lifting and moving devices are available when unloading, unpacking and moving this game.
 ATTENTION 
Be sure the electrical power matches the game requirements. See the serial number located on the back of the game cabinet. Always plug into a grounded circuit. If the supply cord is damaged, it must be replaced by an approved cord or assembly provided by the manufacturer.
 IN CASE OF EMERGENCY 
UNPLUG THE POWER CORD. The power cord must be accessible at all times in case of an emergency.

QUICK SET UP

Place the game near desired location.

Plug in the marquee light power cable to the housing at the top of the back of the cabinet.



Prop the marquee up and secure in place with 5 bolts from the hardware kit in the cashbox.



Plug the power cord (inside the cashbox) into a standard 110V outlet, then switch the power strip inside the cabinet to ON.



MAIN MENU FUNCTIONS

Press the MENU button inside the front door of the cabinet to open the main menu.

Scroll through the selections with the MENU button, and adjust settings with the SELECT button.

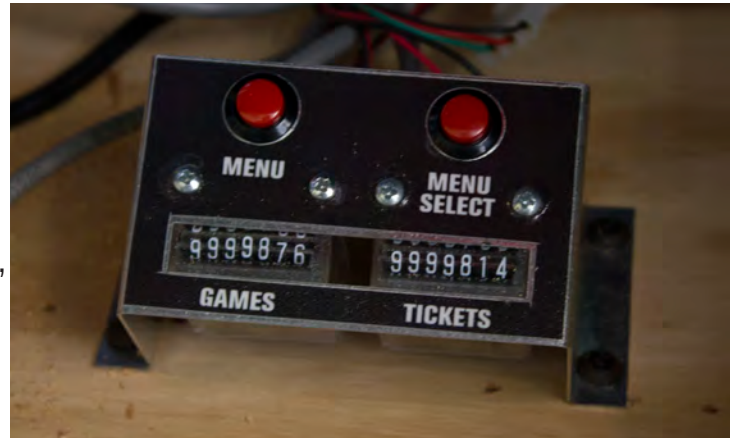

MAIN MENU

Game Volume: 45

Attract Volume: 30

Clear Credits & Tix: 3x's

Game Mode: Redemption

Pay In/Out Menu >>

Game Settings Menu >>

Date Time Menu >>

Statistics Menu >>

Diagnostics Menu >>

Exit

MAIN MENU OPTIONS

Game Volume	0 (off)	to	100 (max)
Attract Volume	0 (off)	to	100 (max)
Clear Credits & Tickets	press select 3 times to clear credits and tickets owed		
Game Mode	Redemption (tickets)	Entertainment Only Merchandiser (prize vendor)	Entertainment Only

SETTINGS MENU



GAME SETTINGS MENU

Number Of Lives: 1 (N/A)

Holiday Theme: Disabled

Difficulty Level: 1

Gap Narrowing Pipe: 5

Back

SETTINGS MENU OPTIONS												
Number of Lives <small>(entertainment & merchandiser only)</small>	1	2	3	4								
Holiday Theme Hats <small>(US holidays)</small>	Pipe 1-15 <small>(pipe passed to get hat)</small>				Disabled							
Difficulty Level <small>(controlled by the size of the vertical gap between pipes. The starting gap size and the number of pipes over which the gap narrows both factor in to these settings)</small>	1 <small>(easy)</small>	2	3	4	5	6	7	8 <small>(hard)</small>	Auto Adjust* <small>(automatically adjusts the difficulty based on trends of player success)</small>			
Gap Narrowing Pipe <small>(the point at which difficulty increases)</small>	START	1	2	3	4	5	6	7	8	9	10	

* Washington State law requires the game to be set to not include the Auto Adjust difficulty level.

PAYOUT MENU (REDEMPTION)



PAY IN/OUT MENU

Credits: 1

Card Reader: Disabled

Divide By 2: Disabled

Fixed Ticket Payout 0

Ticket Pipe Spacing: 1

Ticket Value: 1

Mercy Tickets: 1

Mercy Ticket Value: 1

Bonus 1 Pipe Position: 10

Bonus 1 Ticket Value: 10

Bonus 2 Pipe Position: 20

Bonus 2 Ticket Value: 20

Bonus 3 Pipe Position: 35

Bonus 3 Ticket Value: 50

Bonus 4 Pipe Position: 50

Bonus 4 Ticket Value: 500

Bonus 5 Pipe Position: 60

Bonus 5 Ticket Value: 1000

Ticket Cap: 0

Back

PAYOUT MENU (REDEMPTION)

Factory defaults are highlighted in yellow below.

PAYOUT MENU OPTIONS													
CREDITS PER PLAY	0	1	2	3	4	5	6	7	8	9	10		
CARD SWIPE	ENABLED						DISABLED						
TICKET PIPE SPACING	1	2	3	4	5	6	7	8	9	10			
TICKET VALUE	1	2	3	4	5	6	7	8	9	10			
DIVIDE BY 2 TICKETS	ENABLED						DISABLED						
MERCY TICKETS	0		1		2		3		4		5		
MERCY TICKET VALUE (TICKET IMAGE)	1	2	3	4	5	6	7	8	9	10			
BONUS 1 PIPE POSITION	0 (OFF)			TO		25 PIPES			DEFAULT: 10				
BONUS 1 TICKET VALUE	5 TICKETS			TO		25 TICKETS			DEFAULT: 10				
BONUS 2 PIPE POSITION	0 (OFF)			TO		50 PIPES			DEFAULT: 20				
BONUS 2 TICKET VALUE	5 TICKETS			TO		50 TICKETS			DEFAULT: 20				
BONUS 3 PIPE POSITION	0 (OFF)			TO		100 PIPES			DEFAULT: 35				
BONUS 3 VALUE	25 TICKETS			TO		250 TICKETS			DEFAULT: 50				
BONUS 4 PIPE POSITION	0 (OFF)			TO		150 PIPES			DEFAULT: 50				
BONUS 4 TICKET VALUE	100 TICKETS			TO		1000 TICKETS			DEFAULT: 500				
BONUS 5 PIPE POSITION	0 (OFF)			TO		200 PIPES			DEFAULT: 60				
BONUS 5 TICKET VALUE	100 TICKETS			TO		2500 TICKETS			DEFAULT: 1000				
TICKET CAP	0 (OFF)			TO		2500							

For "NO BONUS" play, turn all bonus pipe positions to 0 (OFF)

TICKET PAYOUT OPTIONS CHART

Find your desired average tickets per game, then select a column based on your desired bonus value.

3-4 AVERAGE TICKETS PER GAME			
PIPE BONUS	NO BONUS- NO MERCY	NO BONUS- 1 MERCY	HIGH BONUS- NO MERCY
PIPE #10	0	0	0
PIPE #20	0	0	0
PIPE #35	0	0	25
PIPE #50	0	0	100
PIPE #60	0	0	0
TICKET VALUE	1	1	1
PIPE SPACING	3	4	5

6-9 AVERAGE TICKETS PER GAME			
PIPE BONUS	NO BONUS	MED BONUS	HIGH BONUS
PIPE #10	0	0	5
PIPE #20	0	10	10
PIPE #35	0	20	50
PIPE #50	0	100	100
PIPE #60	0	0	500
TICKET VALUE	1	1	1
PIPE SPACING	2	4	5

10-13 AVERAGE TICKETS PER GAME			
PIPE BONUS	NO BONUS	MED BONUS	HIGH BONUS
PIPE #10	0	0	5
PIPE #20	0	10	10
PIPE #35	0	20	25
PIPE #50	0	100	100
PIPE #60	0	0	500
TICKET VALUE	2	1	1
PIPE SPACING	3	2	4

14-20 AVERAGE TICKETS PER GAME			
PIPE BONUS	NO BONUS	MED BONUS	HIGH BONUS
PIPE #10	0	5	5
PIPE #20	0	10	10
PIPE #35	0	25	25
PIPE #50	0	100	500
PIPE #60	0	500	1000
TICKET VALUE	1	1	1
PIPE SPACING	1	2	2

TICKET PAYOUT OPTIONS CHART

24-28 AVERAGE TICKETS PER GAME			
PIPE BONUS	NO BONUS	MED BONUS	HIGH BONUS
PIPE #10	0	5	5
PIPE #20	0	10	10
PIPE #35	0	25	25
PIPE #50	0	100	500
PIPE #60	0	500	1000
TICKET VALUE	4	1	1
PIPE SPACING	2	1	1

30-36 (RECOMMENDED DEFAULT) AVERAGE TICKETS PER GAME			
PIPE BONUS	NO BONUS	MED BONUS	HIGH BONUS (DEFAULT)
PIPE #10	0	5	10
PIPE #20	0	10	20
PIPE #35	0	25	50
PIPE #50	0	100	500
PIPE #60	0	500	1000
TICKET VALUE	2	3	1
PIPE SPACING	1	2	1

48-54 AVERAGE TICKETS PER GAME			
PIPE BONUS	NO BONUS	MED BONUS	HIGH BONUS
PIPE #10	0	5	10
PIPE #20	0	10	20
PIPE #35	0	25	50
PIPE #50	0	100	500
PIPE #60	0	500	1000
TICKET VALUE	3	6	2
PIPE SPACING	1	2	1

60-66 AVERAGE TICKETS PER GAME			
PIPE BONUS	NO BONUS	MED BONUS	HIGH BONUS
PIPE #10	0	5	10
PIPE #20	0	10	20
PIPE #35	0	25	50
PIPE #50	0	100	500
PIPE #60	0	500	1000
TICKET VALUE	4	4	3
PIPE SPACING	1	1	1

PAYOUT MENU (MERCHANDISER)



PAY IN/OUT MENU

Credits: 1

Card Reader: Disabled

Merchandise Pipe Position: 20

Back

MERCHANDISE VENDING UNIT COMING SOON!

PAYOUT MENU (ENTERTAINMENT)



PAY IN/OUT MENU

Credits: 1

Card Reader: Disabled

Free Game: Disabled

Back

Entertainment Only option (in Main Menu) must be enabled to select a free game score. A message will be displayed during gameplay to inform the player of how close they are to receiving a free game, as well as when the free game is awarded. Only one free game is allowed per credit inserted.

DATE & TIME MENU



DATE TIME MENU

Change Hour: 13

Change Minute: 15

Change Month: 9

Change Day: 22

Change Year: 2014

Apply Changes

Back

Time: 1:15:53 pm

Date: Mon, Sep 22, 2014

STATISTICS MENU



STATISTICS MENU

Total Games: 61

Total Tickets: 805

Average Tickets: 13

Pipes Cleared: 553

High Score: 46

Daily High Score: 1

HS Beat: 0

Reset Stats: 3x's

Reset NR High Score: 3x's

Save to USB

Back

DIAGNOSTICS MENU



DIAGNOSTICS MENU

Menu Button: Up

Select Button: Up

White Button: Up

Brown Button: Up

Red Button: Up

Green Button: Up

Reset Input Status

Test Ticket Dispense

Change Monitor Light

Default Settings: 3x's

Back

BUTTONS, COUNTERS, COINS, TICKET DISP. WIRING

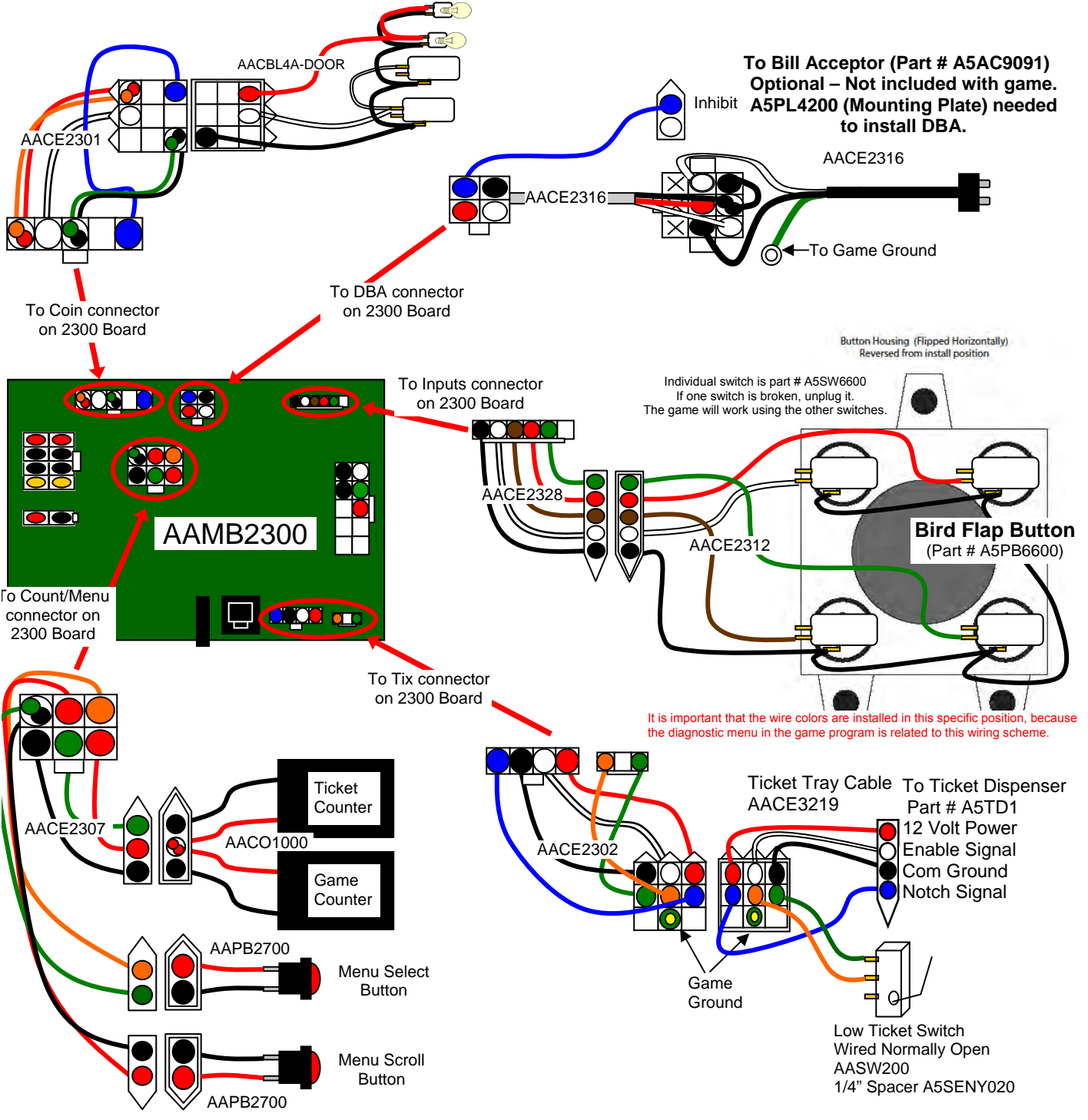

COMMUNICATION, SPEAKER & LED LIGHTING WIRING

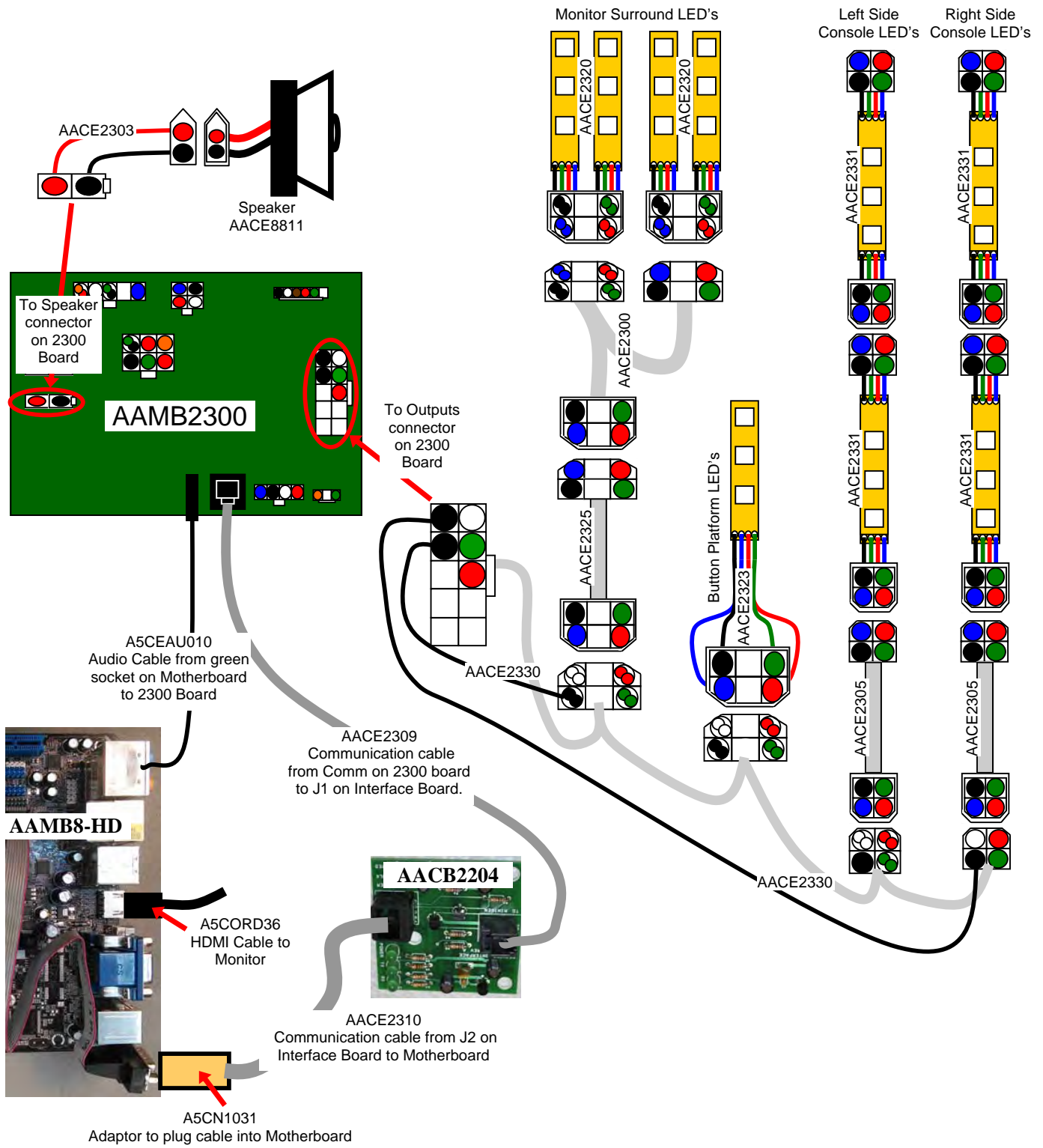

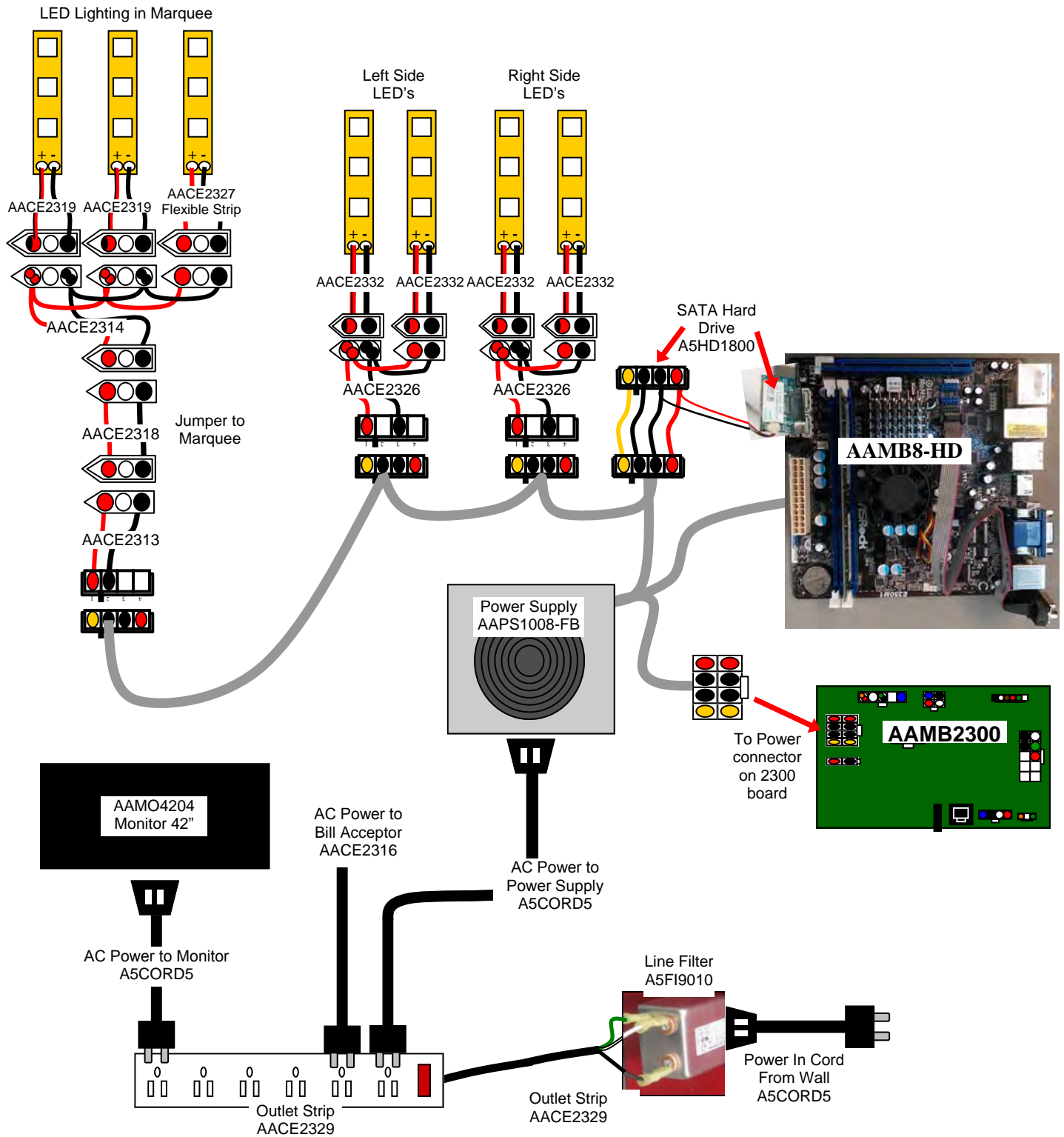

POWER IN / 12 VOLT WIRING



TROUBLESHOOTING GUIDE

Troubleshooting Strategy

Use common sense and a systematic method of troubleshooting to determine the exact problem, probable cause and remedy. Use the process of elimination to find the faulty component. Always check for the simple and obvious causes first such as unplugged, loose or broken wires and bad sensors, bent, pinched, stuck or jammed components.

Problem	Probable Cause	Remedy
<p>No power to the game. No lights on at all.</p>	<p>Unplugged. Circuit breaker tripped. Power strip faulty. Faulty cable/power supply.</p>	<p>Check wall outlet. Reset power strip breaker switch or building circuit breaker. Change plug position, replace if needed. See Power Supply diagnostic section</p>
<p>Bill Acceptor powers on. But everything else off. (Power Supply not ON)</p>	<p>Power supply unplugged. Rocker Switch and voltage switch. Power supply shutting down because of 12 V overload. Faulty power supply.</p>	<p>Insure unit is plugged into power strip. Make sure rocker switch is set ON. (-) and switch at 100V or 230V  See power supply diagnostics to isolate bad component. A bad motor or 12 volt short would cause this. See Power Supply Diagnostic section</p>
<p>Dollar Bill Acceptor not functioning.</p> <p>Ensure Bill Acceptor is set to "Always Enable"</p>	<p>Check for power to Bill Acceptor. Dirt or debris in acceptor slot. Pinched, broken, or disconnected wiring. Bill acceptor problem.</p>	<p>Acceptor should cycle stacker at game power up. If not, check cable connections. Refer to "How to Clean Bill Acceptor" Or clean with bill reader cleaning card. (A5CC9000) Check wiring from bill acceptor to 2300 Board. (AACE2316) Repair or replace wiring harness. Check DBA connector on 2300 Board Make sure wires are secure in connectors. Refer to troubleshooting section of dollar bill acceptor manual included with this game or the diagnostics label of the back of the unit.</p>
<p>Game not coining up.</p>	<p>Ensure game makes "whoosh" sound when coin switch is triggered. Verify communication between motherboard and 2300 board. Game set to large amount of credits per game.</p>	<p>Check coin switches—both should be wired normally open. If one switch is "closed" the other will not work either. Check wiring to 2300 board. (AACBL4A-DOOR, AACE2301) Refer to "Comm Error" troubleshooting section.  Check Pay In/Out Menu. Ensure Credits per Game is set. Default = 4</p>

TROUBLESHOOTING GUIDE

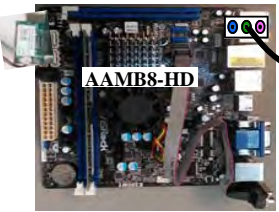
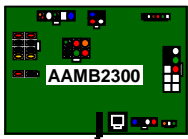
Problem	Probable Cause	Remedy
<p>Cabinet Lighting does not work.</p> <p>There are 2 different types of cabinet lighting</p>	<p>12 Volt White LED's</p> <p>Faulty cable. Disconnected, loose or broken wires.</p> <p>Individual LED strip out</p>	<p>These LED's receive power directly from power supply</p> <p>Refer to "Power In & 12 Volt Wiring Diagram"</p> <p>Identify LED strip, check soldered wires, replace if needed.</p>
<p>12 Volt White LED's & Colored LED's that change color</p> <p>Enter Diagnostic menu and select "Change Monitor Lights"</p>	<p>Colored LED's</p> <p>Faulty cable. Disconnected, loose or broken wires.</p> <p>Individual LED strip out</p> <p>Entire section of LED's do not work</p> <p>Specific Colors do not light on all LED strips</p>	<p>These LED's receive power from 2300 Board</p> <p>Refer to "Communication, Speaker & LED Wiring Diagram"</p> <p>Identify LED strip, check soldered wires, replace if needed.</p> <p>Check main jumper cable (AACE2330) Look for broken wire</p> <p>2300 Board may be faulty. Check connection "Outputs" on main 2300 board. Replace if needed.</p>
<p>Colored LED's not functioning properly</p> <p>Enter Diagnostic menu and select "Change Monitor Lights"</p>	<p>Faulty cable. Disconnected, loose or broken wires.</p> <p>Individual LED strip out</p> <p>Entire section of LED's do not work</p> <p>Specific Colors do not light on all LED strips</p>	<p>These LED's receive power from 2300 Board</p> <p>Refer to "Communication, Speaker & LED Wiring Diagram"</p> <p>Identify LED strip, check soldered wires, replace if needed.</p> <p>Check main jumper cable (AACE2330) Look for broken wire</p> <p>2300 Board may be faulty. Check connection "Outputs" on main 2300 board. Replace if needed.</p>
<p>No Sound</p> <p>Motherboard creates sound, 2300 board amplifies it.</p> <div style="display: flex; align-items: center;">  <div style="text-align: center;">  <p style="font-size: small;">A5CEAU010 Audio Jack from Motherboard to 2300 Board</p> </div> </div>	<p>Volume set to zero in menu.</p> <p>Disconnected, loose or broken wires.</p> <p style="text-align: center;">Determine if 2300 board is ok</p> <p>Faulty speaker.</p>	<p>Enter Main Menu and verify: Game Volume & Attract Volume are not zero</p> <p>Check connections and reseal audio cable from motherboard to 2300 board. Cables # AACE8811, AACE2303, and A5CEAU010.</p> <p>Unplug audio jack cable (A5CEAU010) from motherboard, plug into MP3 player and see if music is amplified and comes out of speaker. If Yes - then motherboard is faulty. If No - then 2300 board may be faulty.</p> <p>Replace speaker. AACE8811</p>

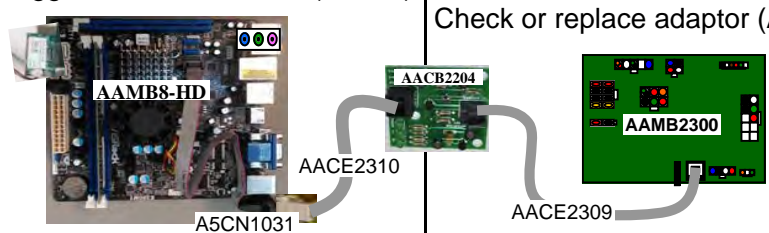

TROUBLESHOOTING GUIDE

Problem	Probable Cause	Remedy
Tickets do not dispense or Wrong amount dispensed. Check for the correct amount of tickets showing on Monitor	Tickets on monitor does not match tickets coming out of game.	Opto Sensor on ticket dispenser dirty. Faulty ticket dispenser. Notch on tickets cut too shallow. Faulty cable. Disconnected, loose or broken wires. Faulty 2300 Board.
	Tickets on monitor does match tickets coming out of game.	Settings in Menu are incorrect.
Low Tickets message on monitor	Tickets are empty in ticket tray Faulty cable. Disconnected, loose or broken wires. Faulty low ticket switch. Faulty MiniGen Board	Load tickets into tray. Ensure tickets hold down micro switch wire. Switch is part # AASW200 Check connectors from low ticket switches to 2300 board. Check for continuity. (AACE3219, AACE2302) Inspect switch and replace if needed. (AASW200) Replace 2300 Board. (AAMB2300)
No Communication between boards. Game does not coin up <div style="background-color: #800000; color: white; padding: 5px; text-align: center; font-weight: bold;">COM ERROR SEE ATTENDANT</div> Game has audio track "clinking" sound from speakers when coin switch triggered.	Check green LED's on Serial Interface board. "Power" solid ON "TX" & "RX" blinking very fast, 	
	If "Power" is not solid ON Ensure AACE1309 cable is plugged into 2300 board. (Comm) 	If "TX" & "RX" are not blinking very fast Communication to Motherboard faulty. Check AACE2310 to motherboard. Check or replace adaptor (A5CN1031)
	If "TX" is solid ON Motherboard is faulty. Replace AAMB8-HD	If "RX" is solid ON 2300 Board is faulty. Replace AAMB2300
	Replace Serial Interface board. (AACB2204)	

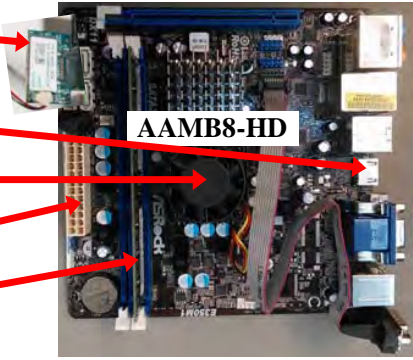

TROUBLESHOOTING GUIDE

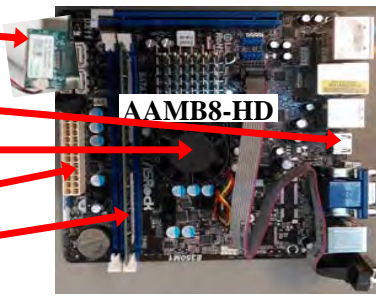
Problem	Probable Cause	Remedy
<p>Game Meter does not work.</p> <p>Game meter will click at end of game.</p>	<p>Verify meter does not click at end of game</p> <p>Disconnected, loose or broken wires.</p> <p>Faulty counters.</p>	<p>This is done because Flappy Bird will not start a game until button is pressed.</p> <p>Check connections and reseal Count/Menu on 2300 board. Cables # AACE2307 and AACO1000</p> <p>Replace counters. AACO1000</p>
<p>Ticket Meter does not work.</p> <p>Ticket meter will click as tickets come out of game and notch is "seen" by dispenser.</p>	<p>Ensure correct number of tickets are being dispensed.</p> <p>Disconnected, loose or broken wires.</p> <p>Faulty counters.</p>	<p>Check ticket values, refer to Tickets not Dispensing troubleshooting section.</p> <p>Check connections and reseal Count/Menu on 2300 board. Cables # AACE2307 and AACO1000</p> <p>Replace counters. AACO1000</p>
<p>Menu Buttons do not work.</p>	<p>Disconnected, loose or broken wires.</p> <p>Faulty button.</p> <p>Faulty communication between motherboard and Minigen</p> <p>Faulty AAMB2300 board.</p>	<p>Check connections from button to 2300 board. Cables # AAPB2700 and AACE2307</p> <p>Test button and replace. (AAPB2700)</p> <p>Refer to "No Communication between boards" troubleshooting section.</p> <p>Replace AAMB2300 board.</p>
<p>Flap Button does not work.</p> <div style="border: 1px solid black; padding: 2px; margin-top: 5px;"> <p>White Button: Up</p> <p>Brown Button: Up</p> <p>Red Button: Up</p> <p>Green Button: Up</p> <p>Reset Input Status</p> <p>Test Ticket Dispense</p> </div>	<p>Enter diagnostic menu and check for stuck buttons.</p> <p>Disconnected, loose or broken wires.</p> <p>Faulty or stuck button.</p> <p>Faulty AAMB2300 board.</p>	<p>If a button shows "stuck" select "Reset Input Status" to clear it and it will go back to "Up"</p> <p>Check connections from pushbutton to 2300 board. Cables # AAPB2700 and AACE1301</p> <p>Refer to "Screen Error Messages" troubleshooting Section to diagnose stuck switch on flap button.</p> <p>Replace AAMB2300 board.</p>
<p>Monitor shows "No Signal" then black.</p> <p style="color: red;">Re-Boot game to see if problem still exists.</p> <p>Power game down, wait 10 seconds, then power game ON to reset.</p> <p>Motherboard/power supply is not working.</p>	<p>Faulty power supply - Check for 12 Volts and blinking green LED on SATA Drive</p> <p>Monitor HDMI cable unplugged.</p> <p>Fan turning.</p> <p>Large power connector unplugged on motherboard.</p> <p>Faulty or loose RAM</p>	<div style="text-align: center;">  </div> <p>Refer to Monitor/Motherboard Power Supply Diagnostics for further diagnostic information.</p>

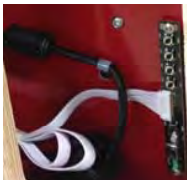
TROUBLESHOOTING GUIDE

Problem	Probable Cause	Remedy
<p>Monitor not working.</p> <p>Monitor says "NO SIGNAL" for 5 seconds after power - up.</p> <p>Then dark.</p>	<p>Faulty power supply - Check for 12 Volts and blinking green LED on SATA Drive</p> <p>Monitor HDMI cable unplugged.</p> <p>Fan turning.</p> <p>Large power connector unplugged on motherboard.</p> <p>Faulty or loose RAM</p> <p>Refer to Monitor/Motherboard Power Supply Diagnostics for further diagnostic information.</p>	
<p>Power down, wait 10 seconds and power up again.</p>	<p>Power cable unplugged from monitor.</p> <p>Faulty monitor.</p>	<p>Ensure power is plugged into back of monitor, down to power strip.</p> <p>Open rear access door.</p> <p>Push ON button on monitor's satellite board.</p> <p>Replace monitor. (AAMO2200)</p>
 <p>Error on screen at power up.</p> <p style="color: red;">Re-Boot game to see if problem still exists.</p> <p>Power game down, wait 10 seconds, then power game ON to reset.</p>	<p>Monitor shows ASROCK SETUP UTILITY"</p> <p>Display shows "Sleep Mode" on screen.</p> <p>Display shows "Kernel panic – unable to mount root" on screen.</p> <p>Display shows anything other than Dizzy Chicken software on Screen.</p>	<p>SATA Drive unplugged from board or faulty Refer to "Monitor shows ASROCK SETUP UTILITY" section.</p> <p>Power Supply or Motherboard not Communicating correctly with monitor. Refer to "Monitor shows Sleep Mode on screen" section.</p> <p>Faulty or loose RAM Refer to "Monitor shows Kernel panic – unable to mount root" section.</p> <p>Motherboard is not loading or running program. Refer to "Monitor shows anything other than Dizzy Chicken software on screen" section.</p>
<p>Monitor shows nothing at all on power on.</p> <p>Open rear access door.</p> <p>Push ON button on monitor's satellite board.</p> 	<p>Power cable unplugged from monitor.</p> <p>Power strip faulty</p> <p>Faulty power cable for monitor</p> <p>Re-Boot game and check for any errors on monitor. Power game down, wait 10 seconds, then power game ON to reset.</p> <p>Faulty monitor.</p>	<p>Ensure power is plugged into bottom of monitor, down to power strip.</p> <p>Change plug position, replace if needed (AACE2329)</p> <p>Check A5CORD5 to ensure 110 volts to Monitor.</p> <p>If error shows on monitor, refer to suggestions above.</p> <p>Replace monitor. (AAMO4204)</p>

TROUBLESHOOTING GUIDE

Problem	Probable Cause	Remedy
<p>Monitor shows “ASROCK SETUP UTILITY”</p> 		<p>Small clip-in hard drive is not being seen by computer.</p> <p>Push on spring clip and gently remove from motherboard. Re-install and power on game.</p> <p>Try in different SATA slot on motherboard.</p> <p>Replace hard drive. (A5HD1800)</p> <p>Replace motherboard. (AAMB8-HD)</p>
<p>Monitor shows “Sleep Mode” on screen.</p> <p style="color: red;">Re-Boot game to see if problem still exists.</p> <p>Power game down, wait 10 seconds, then power game ON to reset.</p>	<p>Power Supply or Motherboard not communicating correctly with monitor.</p>	<p>Check power supply voltage.</p> <p>Replace power supply. (AAPS1008-FB)</p> <p>Ensure power supply connection is secure to motherboard.</p> <p>Refer to Monitor/Motherboard Power Supply Diagnostics</p> <p>Replace motherboard. (AAMB8-HD)</p>
<p>Monitor shows “Kernel panic-unable to mount root” on screen.</p>	<p>Faulty or loose RAM</p>	<p>Separate metal tabs on sides of RAM, it will flip up to remove.</p> <p>Re-install and Re-Boot game to see if problem still exists.</p> <p>Power game down, wait 10 seconds, then power game ON to reset.</p> <p>Replace motherboard. (AAMB8-HD)</p>
<p>Monitor shows anything else other than Flappy Bird program on screen.</p> <p style="color: red;">Re-Boot game to see if problem still exists.</p> <p>Power game down, wait 10 seconds, then power game ON to reset.</p>	<p>Motherboard has trouble loading or running program</p>	<p>Large power connector unplugged on Motherboard</p> <p>Faulty or loose RAM</p> <p>Faulty motherboard - Replace faulty board. (AAMB8-HD)</p>
<p>Monitor problems</p> <p>Blurry Monitor Too bright, or dim.</p>	<p>Press the auto button to select Auto Adjustment. This may take a few seconds.</p> <p>Verify that the screen looks good and Image is centered.</p>	

ON-SCREEN ERROR MESSAGES

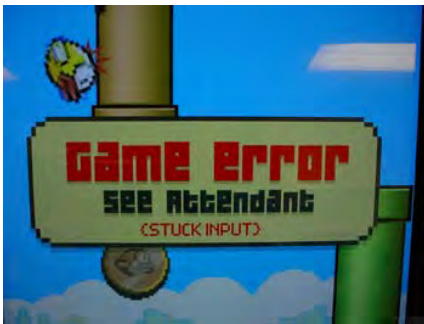

The push button to flap the bird consists of 4 individual switches that work together. If a single switch breaks, the game software will ignore it and the game will continue working. Up to 3 switches can fail and the game will still function properly. (you may notice that you must push button harder to flap the bird)

If all 4 switches fail, then this error will show on display.

Game Error See Attendant means the game is reading all 4 flap bird buttons as closed inputs.

Button Housing (Flipped Horizontally)
Reversed from install position

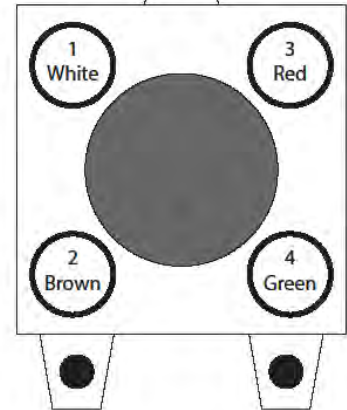

Remove flap button from machine. (Refer to "How to Remove Flap Button")

Flip button housing upside and refer to diagram to check/replace individual switches (A5SW6600) or replace the entire assembly (A5PB6600)

After fixing switch, enter diagnostic menu and button will show "stuck". Select "Reset Input Status" to clear it and it will go back to "Up"

It is important that the wire colors are installed in this specific position, because the diagnostic menu in the game program is related to this wiring scheme.



The 2300 board must communicate to the motherboard for the game to operate correctly.

Com Error See Attendant means the game knows that these boards are not communicating.

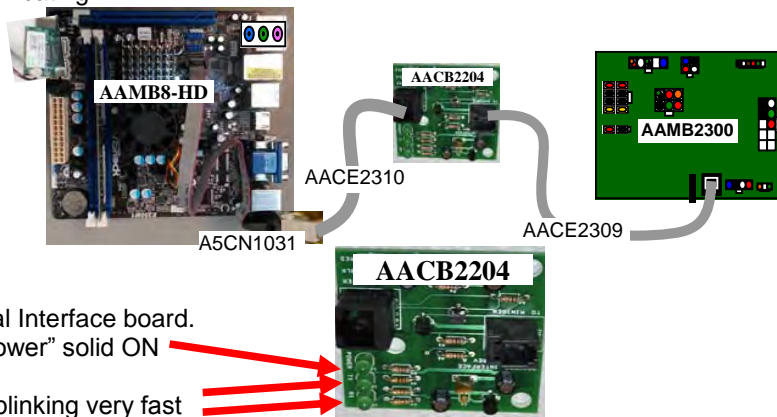

Check green LED's on Serial Interface board.

"Power" solid ON

"TX" & "RX" blinking very fast

<p>If "Power" is not solid ON Power is supplied by 2300 board.</p> <p>Ensure AACE1309 cable is plugged into 2300 board. (Comm)</p>	<p>If "TX" & "RX" are not blinking very fast No communication from 2300 to Motherboard.</p> <p>Check AACE2310 to motherboard. Check or replace adaptor (A5CN1031) Replace Serial Interface board. (AACB2204) Possible faulty port on motherboard or 2300 board.</p>
<p>If "TX" is solid ON Motherboard is faulty. Replace AAMB8-HD</p>	<p>If "RX" is solid ON 2300 Board is faulty. Replace AAMB2300</p>

HOW TO: REMOVE PLAYER BUTTON



Remove power to game.
Remove 4 screws on back side of button tower. (#2 square)



Remove single nut from top side of button assembly using 7/16" socket wrench

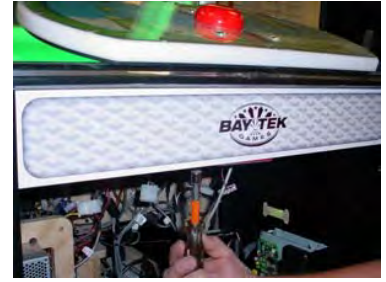

Open front door and remove large clear plastic spill guard. Remove 2 nuts from bottom side of button assembly using 7/16" nut driver



Carefully remove button from machine as wiring harness will come out with button.

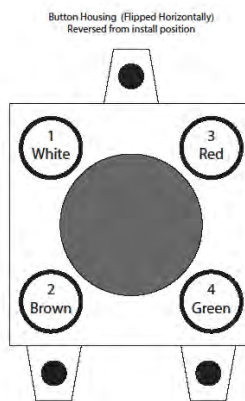

Check/replace individual switches (A5SW6600)
Or replace the entire assembly (A5PB6600)

It is important that the wire colors are installed in this specific position, because the diagnostic menu in the game program is related to this wiring scheme.

HOW TO: REPLACE OUTLET STRIP / LINE FILTER

The outlet strip and line filter connections are enclosed in wood for your protection.
If these items need to be replaced, follow these instructions.

Remove power from game.

Remove 6 screws on back side of rear monitor tower. (#2 square)

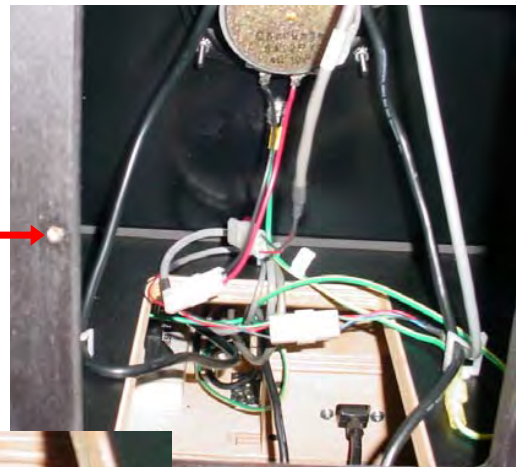

Remove 4 black screws in wood plate. (#2 square)

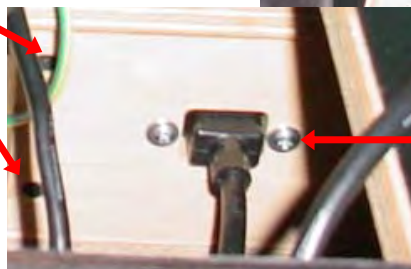

Remove 2 silver screws that hold in line filter. (Phillips)

MONITOR / MOTHERBOARD POWER SUPPLY DIAGNOSTICS

1.) Verify AC power to game. Check power strip in front door.



The rocker switch should be illuminated.

3.) Check connection to power supply.

4.) Ensure Power Supply switch is set to 115V (or 230V)
(Some model power supplies may not have this)

5.) Ensure Power switch is on.

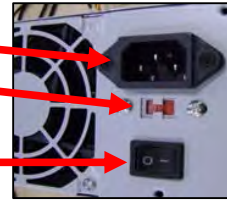

6.) Ensure fan is turning.

- If power supply fan is turning and there is no 12 Volt out, then replace power supply. (AAPS1008-FB)
- If power supply fan is not turning, then continue to "Verify Power to Motherboard"

Verify Power to Motherboard

The motherboard will turn on power supply.

If your game has no 12 volts, it may be the motherboard not turning on.

In addition - there may be a 12 volt short somewhere else in cabinet that is not allowing the power supply to turn on.

Minimize load on power supply and isolate short

Unplug all outputs from power supply except for motherboard.

This will have power supply, motherboard, and monitor left plugged in.

If power supply, motherboard, and monitor now turn on:

Plug in one component at a time to power supply to locate short.

If power supply still does not power on, then continue to steps 1,2, and 3.

1 - Check single connection from power supply.

2 - Verify these pins are covered by connector with a single capacitor.

If the connector is missing, continue to step 3 to jump the pins under this connector.

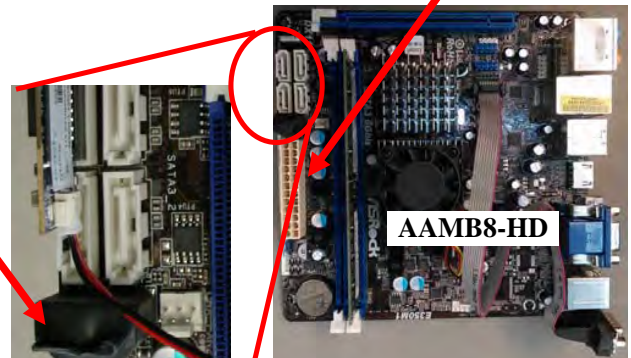

3 - Motherboard "Jump Start"

As a last resort, you may start motherboard by quickly touching these 2 pins at the same time, then quickly release

Motherboard may turn ON and boot normally.

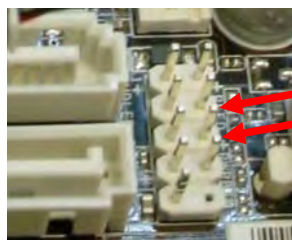

If power supply still does not power on, replace power supply (AAPS1008-FB) or motherboard. (AAMB8-HD)

BILL ACCEPTOR DIAGNOSTICS

The Flappy Bird Game is Bill Acceptor ready. We recommend MEI AE-2451-U5E (Part # A5AC9091) If you would like to add one to the game, please make sure the mounting plate is present. (A5PL4200)

Note: There are many different models and brands of Bill Acceptors that are used on redemption games. Your Bill Acceptor may differ from the unit shown.

Determine if Bill Acceptor has power:

Turn game ON—The bill acceptor should make noise as stacker cycles and green lights on outside bezel should flash.

If NO power:

Use meter to measure 110 AC voltage at cable going into Bill Acceptor from power strip.

If power is OK:

Clean Bill Acceptor path to make sure there is nothing jamming unit.

Check dipswitch settings on side of acceptor.

Make sure switch # 8 is OFF for Always Enable

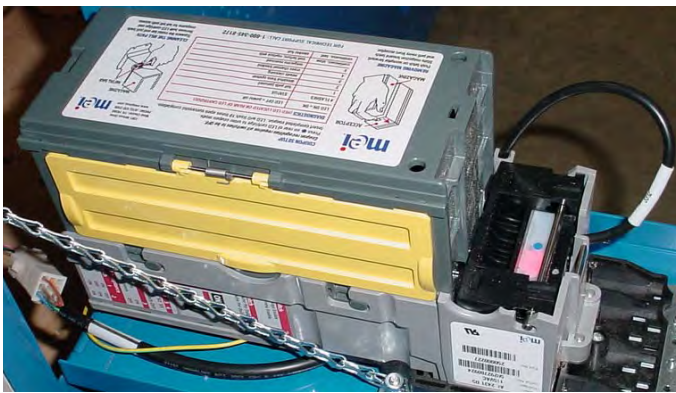

ERROR CODES

Count the number of flashes on front bezel of Bill Acceptor and follow chart for repair.

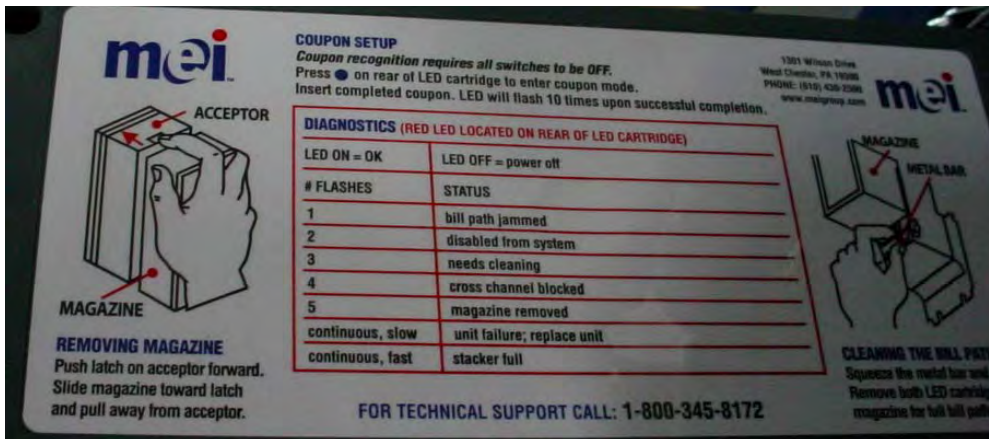

CARD SWIPE SYSTEM INSTALLATION

The Flappy Bird game is pre-wired to accept Card Swipe systems from many manufactures. Please follow these instructions to make full use of Flappy Bird capabilities.

Option #1:

New card swipe systems may come with a standard 9 pin Molex connector. Simply unplug this connector and plug into your card swipe reader.

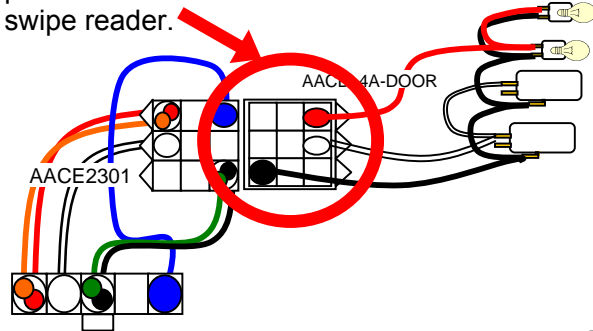

Option #2:

If your card swipe systems does not have a standard 9 pin Molex connector, then you will have to splice wires into the AACE2301 harness.

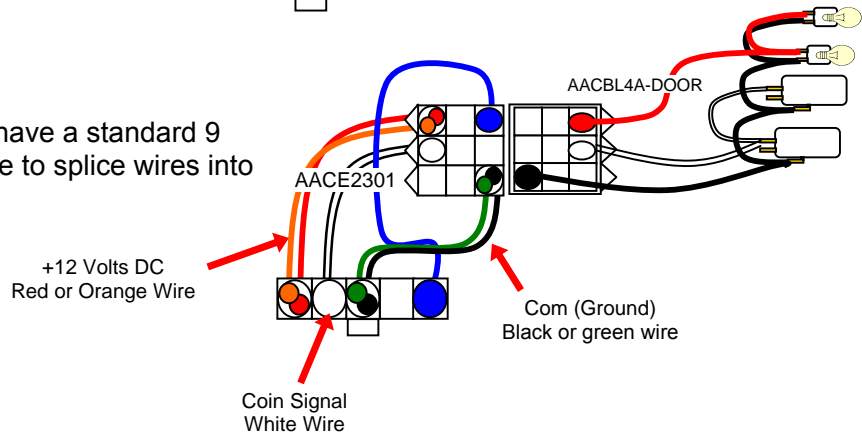

Menu Changes

Enter menu, go to "Pay In/Out" Menu
Change "Credits" to 1
Change "Card Reader" to Enabled



Additional:

Baytek sells an optional sticker sheet that will cover up the "Insert Coin" on many different types of games. Part # A5DE0047

Example: Stick on Big Bass Wheel to cover "Insert Coin" artwork.

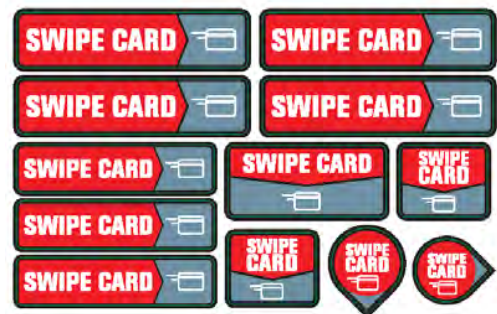

2300 BOARD CONNECTOR PINOUT GUIDE

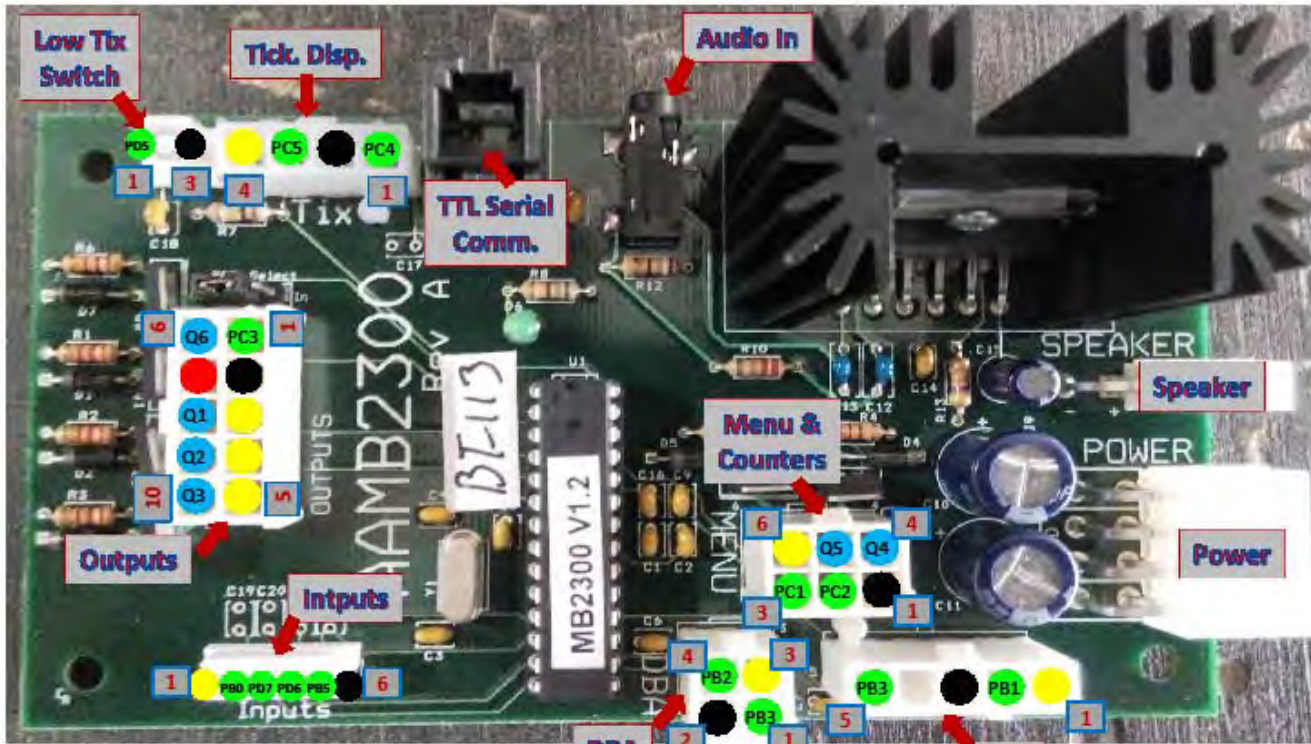

- GROUND
- +5VDC
- +12VDC
- LOWSIDE OUTPUT
- TTL LOGIC



POWER



SPEAKER

** PC3 and Q6 use the same I/O line. If using PC3 as an input select "IN" on the jumper above the "Outputs" header. If using PC3 to control FET Q6, set the jumper to "Out"

PARTS LIST

PART #	DESCRIPTION	PART #	DESCRIPTION
A5CB8020	Cash Box	A5CORD5	AC Computer Cord
A5FI9010	Inline Filter	A5CORD36	HDMI Cable To Monitor
A5PB6600	Big Red Push Button	A5CEAU010	Audio Stereo Cable
A5SW6600	Single Switch For Button (4 Per)	AACBL4A-DOOR	Door Cable
AASW200	Low Ticket Switch	AACE1715	Ground Cable
W5TM1316	13/16" Black/Silver T-Molding	AACE2300	Monitor Lights Jumper
A5TR2300	Trim Around Marquee & Monitor Vacuum Form (Per Ft)	AACE2301	Coin Door Cable
A5CN1031	Monitor Connector Adapter	AACE2302	Ticket Tray/Low Ticket Cable
A5LK2001	Cash Box Lock (A05 Key)	AACE2303	Speaker Cable
A5LK5002	Cabinet Lock (C15 Keys)	AACE2305	Left & Right Side Lights Jumper
A5HO1003	Holder For Light Bar	AACE2307	Menu Buttons Cable
AACO1000	Counter	AACE2309	MicroGen Communication Cable To Interface
AAPB2700	Red Push Button, Menu Select	AACE2310	MB8 Communication Cable To Interface
A5BK1013	Push Button/Counter Bracket	AACE2312	Play Button Cable
A5ME2311	Metal Tough Screen Stand	AACE2313	Flappy Marquee Jumper
A5ME2312	Metal Side Rails	AACE2314	Marquee Lights Jumper
A5ME4179	Ticket Tray Bracket	AACE2316	DBA Cable
A5ME4182	Metal Coin Box Guide	AACE2318	12 Volt Jumper Cable to Marquee
A5PL4200	Bill Acceptor Plate	AACE2319	LED White Light Strips (2 Per)
A5PL8900	Blanking Plate For Bill Validator	AACE2320	LED's Around Monitor (2 Per)
A5TT4100	Ticket Tray	AACE2321	Ground to Filter Cable
A5TD1	Ticket Dipenser	AACE2322	Monitor Stand Ground Cable
AAPS1008-FP	Power Supply	AACE2323	Light Panel Control Cable
AAMO4204	42" Monitor With Wood	AACE2325	Jumper To Monitor Around LED's (2 Per)
A5DE0042	New Menu/Volume Pot Decal	AACE2326	Jumper to Side LED's (2 Per)
A5DE2300	Top Cabinet Decal	AACE2327	Marquee Lights Cable
A5DE2301	Left Side Vent Decal	AACE2328	Main Bd Push Button Cable
A5DE2302	Right Side Vent Decal	AACE2329	Power Strip Assembly
A5DE2303	Front Top Decal (With Bay Tek Logo)	AACE2330	Jumper to LED Outputs
A5DE2304	Front Middle Decal, Bottom Cabinet	AACE2331	Side Tower Strip Lights (4 per)
A5DE2305	Front Bottom Decal, Bottom Cabinet	AACE2332	Side Tower White Stick Lights (4 Per)
A5DE2306	Coin Door Decal, Bottom Cabinet	AACE3219	Ticket Dispenser/Low Ticket Switch Cable
A5DE2310	Flappy Bird Marquee Decal	AACE8811	Speaker Assembly
A5DE2311	Console Decal (Around The Button)	A5HD1800	SATA Drive
A5DE2312	Left Side Bottom Decal, Bottom Cabinet	AACB2204	Communication Board
A5DE2313	Right Side Bottom Decal, Bottom Cabinet	AAMB2300	Micro Gen Board
AAVF2300	Vacuum Form With Vent Decals (Around Monitor)	AAMB8-HD	Motherboard With Hard Drive

PARTS IDENTIFICATION

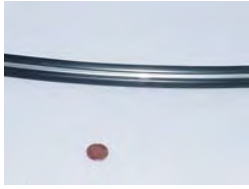

W5TM1316



AASW200



AAPS1008-FB



A5F19010



AAPB2700



A5HO1003



A5CB8020



A5TT4101



A5ME4179



A5DE2300



A5DE2303

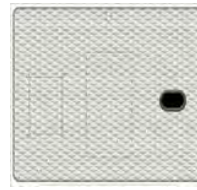

A5DE2304

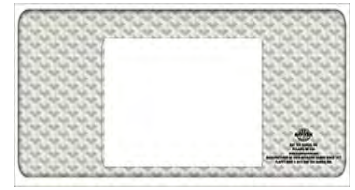

A5DE2305

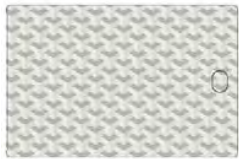

A5DE2306



A5DE2310



A5DE2311



A5DE2312



A5DE2313



AACB2204



A5CN1031



AAMB2300



A5TD1

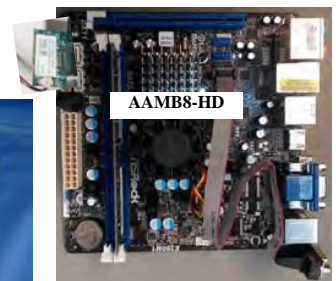

AAMB8-HD

PARTS IDENTIFICATION



AACE2300



AACE2301



AACE2302



AACE2303



AACE2305

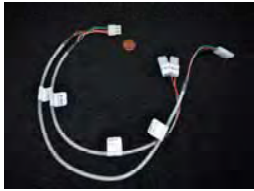

AACE2307



AACE2309



AACE2310



AACE2312

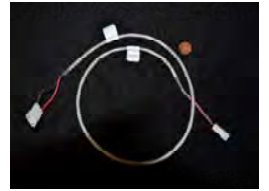

AACE2313



AACE2314



AACE2316



AACE2318



AACE2319



AACE2321



AACE2322



AACE2323



AACE2325

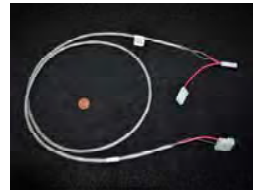

AACE2326



AACE2327



AACE2328



AACE2329



AACE2330



AACE2331



AACE2332



AACE3219



AACE8811



AACO1000



A5CORD5



A5CEAU010

DECAL PLACEMENT GUIDE

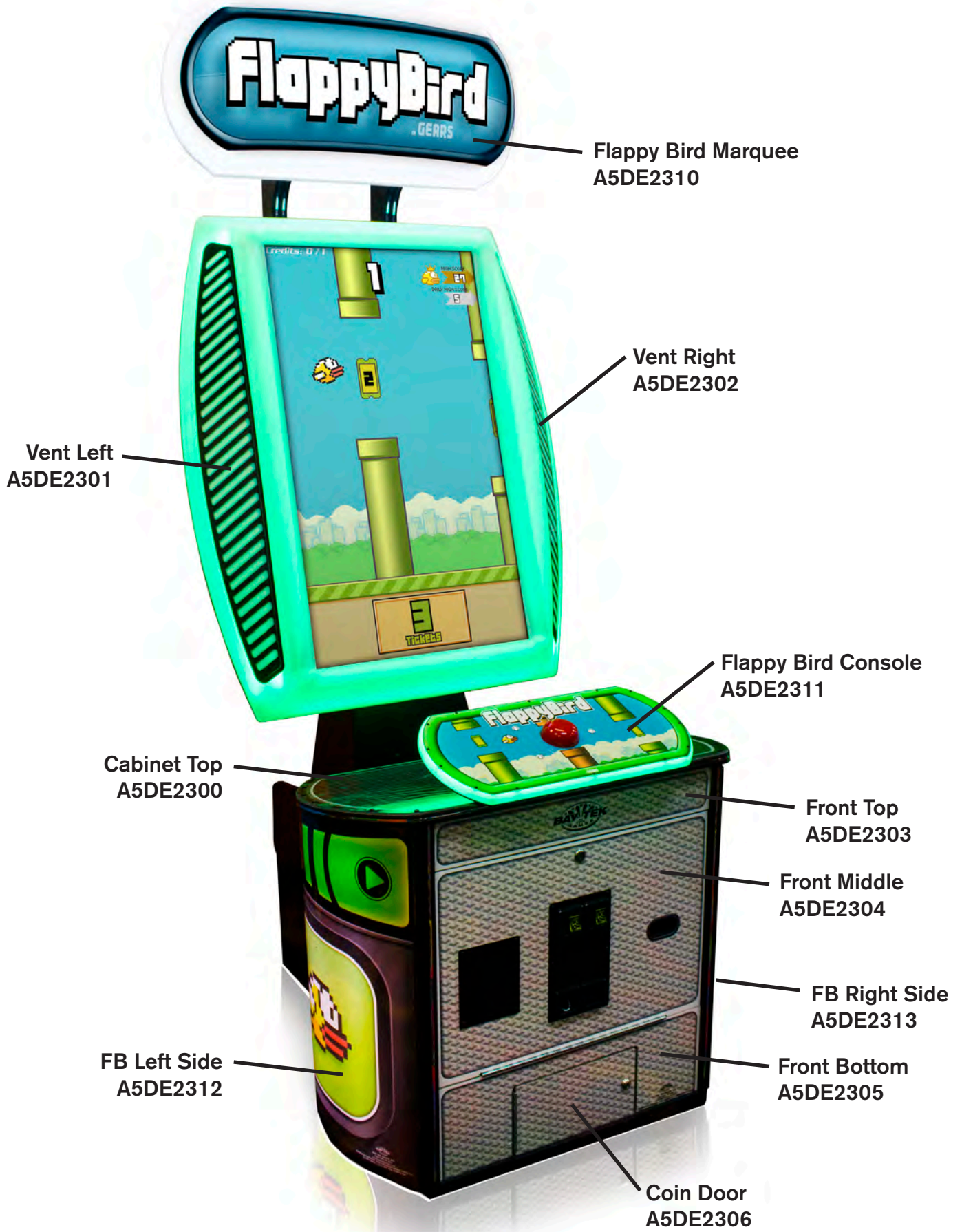

MAINTENANCE LOG

If repairs are necessary, it is good practice to keep a log of repairs done and parts ordered.
 The chart below will assist you in tracking your game's maintenance.

DATE	MAINTENANCE PERFORMED	PARTS ORDERED	INITIALS

TECHNICAL SUPPORT

Excellent customer service is very important to Bay Tek Games!

We know that keeping your games in great operating condition is important to your business. When you need us, we are here to help. You can call us for free technical assistance, and you can count on us to have parts on-hand to support your game. We offer options that fit your needs.

Electronics / Circuit Boards - Repair Options

Repair & Return – If you have Circuit Board issues with your Bay Tek game, you can send the board to us and we'll repair it right away. Most items sent to us are repaired and returned to you within two days. This option is your best value as we offer this fast turn-around service at the most reasonable price.

Advance Replacement – If you have Circuit Board issues with your Bay Tek game, but you don't have time to send in your board in for repair, give us a call and ask for an Advance Replacement. We'll send you a replacement board that same day (pending availability). When you get your new board, just repackage the defective board in the same box and send it back to us. We make it easy by including a UPS Return Shipping label for you to put on the box (not available for international shipments). This is your best option when you need to get your game up and running as quickly as possible!

Spare Parts – Take matters into your own hands and purchase new spare Circuit Boards for your Bay Tek games. Many of our games share the same main-board electronics. This means you can buy one set of spare electronics to support many of your Bay Tek games. Spare boards allow you to get your game up and running the quickest and provide you a valuable troubleshooting option. Call our technicians to get recommendations for what you should keep on hand for spare parts!

Technical Support:

"You" are the best tool for troubleshooting! Your abilities to understand the game and your skills to repair the game are invaluable to us! If you need help, you know you can call us. It's not easy to diagnose a game remotely by phone, but our technicians do a great job. They'll need your help to perform some troubleshooting steps and convey to them exactly what's happening with your game.

Returns, Credits, & Fees:

NOTICE! ALL ITEMS being sent to Bay Tek Games for repair or return, etc. require prior Return Authorization! Bay Tek Games will provide a Product Return Form with an authorizing Ticket Number for each item to be returned. Please be certain to include this document with all shipments!

Late Fees and Non-Return Fees - Advance Replacement and Warranty Replacement items require the defective items to be returned by Bay Tek games promptly to avoid Late Fees. We expect items to be returned within 10 working days. Late fees are invoiced monthly. Late fees are non-refundable under any circumstance! Any item not returned within 90 days will be invoiced in full as a replacement part.

Bench Fees - Bench fees will apply for each electronic item returned to Bay Tek Games (this includes unused Advance Replacement items). This charge covers our cost to inspect, evaluate and retest each item. Please note that returned items that do not pass our tests will be charged accordingly as replacement items or advance replacements.

Restocking Fees - Unused items returned for credit will be credited minus a restocking fee. Items must be returned within 30 days of purchase in order to qualify for any credit amount. No shipping charges will be credited.

WARRANTY

Bay Tek Games warrants to the original purchaser that all game components will be free of defects in workmanship and materials for a period of 6 months from the date of purchase. If you fill out the registration card in the cashbox of the game, Bay Tek will add another 3 months to your warranty, free of charge.

Bay Tek Games will, without charge, repair or replace defective component parts upon notification to the parts/service department while the game is under warranty.

Warranty replacement parts will be shipped immediately, via ground service, along with a Product Return Form for the return of defective parts.

Defective parts must be shipped back to Bay Tek Games unless otherwise instructed. Items not returned to Bay Tek Games will be invoiced as replacement parts.

This warranty does not apply in the event of any misuse or abuse to the product, or as a result of any unauthorized repairs or alterations. The warranty does not apply if any serial number decal is altered, defaced, or removed from its original position.

 **ATTENTION** 

In order to maintain the safety & compliance certifications of this game, **ONLY** approved parts may be used. For approved replacement parts, refer to the parts list in this manual.

Should you need your game serviced, determine the serial number from the decal placed on the front of this manual, or locate it on the back of the game. Then contact our Service Department at: 920.822.3951 or e-mail: service@baytekgames.com

NON-WARRANTY

Options and estimated charges will be provided to you for your approval.

Please remember that any items being sent to Bay Tek Games must include prior return authorization from our Parts & Service Department.

This approval will include a Product Return Form which is required to be included with any incoming shipments. Repaired parts will be shipped back using the same method in which they were received.

Repairs are warranted for 30 days from the date of return shipment.