

**YAMAHA**

**TDM850 '97**

4TX-AE2

**SUPPLEMENTARY  
SERVICE MANUAL**

---

## FOREWORD

This Supplementary Service Manual has been prepared to introduce new service and data for the TDM850 '97. For complete service information procedures it is necessary to use this Supplementary Service Manual together with the following manual.

**TDM850 '96 SERVICE MANUAL: 4TX-AE1**

**TDM850 '97  
SUPPLEMENTARY  
SERVICE MANUAL**

**© 1996 by Yamaha Motor Co., Ltd.  
First Edition, October 1996 All rights  
reserved.**

**Any reproduction or unauthorized use  
without the written permission of  
Yamaha Motor Co., Ltd.  
is expressly prohibited.**

## NOTICE

This manual was produced by the Yamaha Motor Company primarily for use by Yamaha dealers and their qualified mechanics. It is not possible to include all the knowledge of a mechanic in one manual, so it is assumed that anyone who uses this book to perform maintenance and repairs on Yamaha motorcycles has a basic understanding of the mechanical ideas and the procedures of motorcycle repair. Repairs attempted by anyone without this knowledge are likely to render the motorcycle unsafe and unfit for use.

Yamaha Motor Company, Ltd. is continually striving to improve all its models. Modifications and significant changes in specifications or procedures will be forwarded to all authorized Yamaha dealers and will appear in future editions of this manual where applicable.

### NOTE:

---

Designs and specifications are subject to change without notice.

---

## IMPORTANT INFORMATION

Particularly important information is distinguished in this manual by the following notations.



The Safety Alert Symbol means ATTENTION! BECOME ALERT! YOUR SAFETY IS INVOLVED!



Failure to follow WARNING instructions could result in severe injury or death to the motorcycle operator, a bystander or a person inspecting or repairing the motorcycle.

### CAUTION:

A CAUTION indicates special precautions that must be taken to avoid damage to the motorcycle.

### NOTE:

A NOTE provides key information to make procedures easier or clearer.

# HOW TO USE THIS MANUAL

## MANUAL ORGANIZATION

This manual consists of chapters for the main categories of subjects. (See "Illustrated symbols".)

1st title ①: This is the title of the chapter with its symbol in the upper right corner of each page.

2nd title ②: This title indicates the section of the chapter and only appears on the first page of each section. It is located in the upper left corner of the page.

3rd title ③: This title indicates a sub-section that is followed by step-by-step procedures accompanied by corresponding illustrations.

## EXPLODED DIAGRAMS

To help identify parts and clarify procedure steps, there are exploded diagrams at the start of each removal and disassembly section.

1. An easy-to-see exploded diagram ④ is provided for removal and disassembly jobs.
2. Numbers ⑤ are given in the order of the jobs in the exploded diagram. A number that is enclosed by circle indicates a disassembly step.
3. An explanation of jobs and notes is presented in an easy-to-read way by the use of symbol marks ⑥. The meanings of the symbol marks are given on the next page.
4. A job instruction chart ⑦ accompanies the exploded diagram, providing the order of jobs, names of parts, notes in jobs, etc.
5. For jobs requiring more information, the step-by-step format supplements ⑧ are given in addition to the exploded diagram and the job instruction chart.

② CLUTCH

① ENG

④

**CLUTCH**  
**CRANKCASE COVER (RIGHT)**

⑥

⑤

⑦

Order	Job name/Part name	Qty	Remarks
<b>Crankcase cover (right) removal</b>			
	Engine oil		Remove the parts in the order below. Refer to "ENGINE OIL REPLACEMENT" in CHAPTER 3.
1	Clutch cable	1	
2	Crankcase cover (right)	1	<b>NOTE:</b> Loosen the bolts in a crisscross pattern.
3	Gasket	1	
4	Dowel pin	2	
5	Clutch	1	
6	Plain washer	1	
7	Pull lever	1	
8	Torsion spring	1	
9	Plain washer	1	
For installation, reverse the removal procedure.			

4-29

CLUTCH

ENG

③

⑧

**REMOVAL**

1. Straighten the lock washer tab.
2. Remove:
  - Clutch boss nut ①
  - Lock washer ②
  - Clutch boss ③

**NOTE:**  
Loosen the clutch boss nut ① while holding the clutch boss ③ with the universal clutch holder.

**Universal clutch holder:**  
90890-01086

3. Remove:
  - Spacer ④
  - Bearing ⑤

**NOTE:**  
Install 8 mm bolts ⑥ onto the spacer. Then remove the spacer by pulling.























**INSPECTION**

1. Measure:
  - Friction plate thickness
  - Out of specification → Replace friction plates as a set.
  - Measure at four points.

**Thickness:**  
2.9 - 3.1 mm  
◀Limits: 2.8 mm
2. Measure:
  - Clutch plate warpage
  - Out of specification → Replace clutch plate as a set.
  - Use a surface plate and feeler gauge ⑦.

**Warp limit:**  
Less than 0.1 mm
3. Measure:
  - Free length (clutch spring) ⑧
  - Out of specification → Replace springs as a set.

**Free length (clutch spring):**  
55 mm  
◀Limits: 53 mm

① GEN INFO 	② SPEC 	
③ INSP ADJ 	④ ENG 	
⑤ COOL 	⑥ CARB 	
⑦ CHAS 	⑧ ELEC 	
⑨ TRBL SHTG ?	⑩ 	
⑪ 	⑫ 	
⑬ 	⑭ 	
⑮ 	⑯ 	⑰ 
⑱ 	⑲ 	⑳ 
㉑ 	㉒ 	㉓ 
㉔ 	㉕ <b>New</b>	

EB003000

## ILLUSTRATED SYMBOLS

Illustrated symbols ① to ⑨ are printed on top right of each page and indicate the subject of each chapter.

- ① General information
- ② Specifications
- ③ Periodic inspections and adjustments
- ④ Engine
- ⑤ Cooling system
- ⑥ Carburetion
- ⑦ Chassis
- ⑧ Electrical
- ⑨ Troubleshooting

Illustrated symbols ⑩ to ⑰ are used to identify the specifications appearing in the text.

- ⑩ Can be serviced with engine mounted
- ⑪ Filling fluid
- ⑫ Lubricant
- ⑬ Special tool
- ⑭ Torque
- ⑮ Wear limit, clearance
- ⑯ Engine speed
- ⑰  $\Omega$ , V, A

Illustrated symbols ⑱ to ㉓ in the exploded diagrams indicate the types of lubricants and lubrication points.

- ⑱ Apply engine oil
- ⑲ Apply gear oil
- ⑳ Apply molybdenum disulfide oil
- ㉑ Apply wheel bearing grease
- ㉒ Apply lightweight lithium soap base grease
- ㉓ Apply molybdenum disulfide grease

Illustrated symbols ㉔ to ㉕ in the exploded diagrams indicate where to apply a locking agent ㉔ and when to install new parts ㉕.

- ㉔ Apply locking agent (LOCTITE®)
- ㉕ Replace

---

# CONTENTS

<b>GENERAL INFORMATION</b> .....	1
MOTORCYCLE IDENTIFICATION .....	1
VEHICLE IDENTIFICATION NUMBER .....	1
MODEL LABEL .....	1
<b>SPECIFICATIONS</b> .....	2
GENERAL SPECIFICATIONS .....	2
MAINTENANCE SPECIFICATIONS .....	3
ENGINE .....	3
CHASSIS .....	3
ELECTRICAL .....	4
<b>CARBURETION</b> .....	5
CARBURETOR .....	5
FUEL LEVEL ADJUSTMENT .....	5
<b>TDM850 '97 WIRING DIAGRAM</b>	

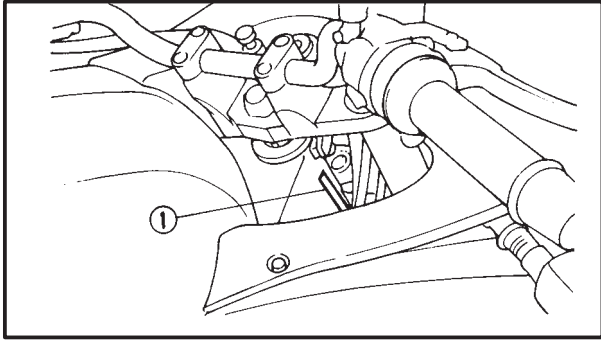

EB100000

## GENERAL INFORMATION MOTORCYCLE IDENTIFICATION VEHICLE IDENTIFICATION NUMBER

The vehicle identification number ① is stamped into the right side of the steering head.

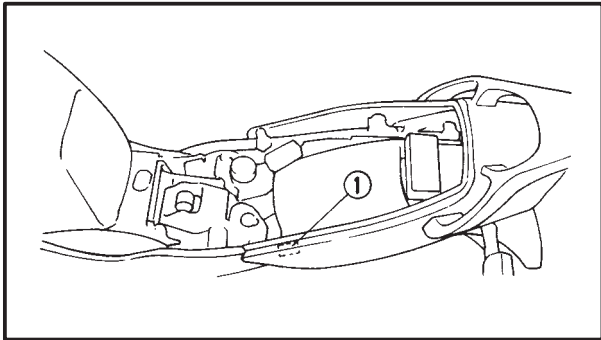

## MODEL LABEL

The model label ① is affixed to the frame.

This information will be needed to order spare parts.

## GENERAL SPECIFICATIONS

**SPEC**



### SPECIFICATIONS

#### GENERAL SPECIFICATIONS

Item	Standard
Model:	TDM850
Model code:	4TX2 5AR1 (CH,A)
Dimensions:	
Overall length	2,200 mm
Overall width	790 mm
Overall height	1,285 mm
Seat height	805 mm
Wheelbase	1,475 mm
Minimum ground clearance	165 mm
Minimum turning radius	2,900 mm
Radiator:	
Radiator capacity (including all routes)	1.7 L
Tire:	
Type	Tubeless
Size	110/80 ZR18 150/70 ZR17
Manufacturer	BRIDGESTONE*/PIRELLI/MICHELIN BRIDGESTONE*/PIRELLI/MICHELIN
Type	BT54F/MTR03/MACADAM 90X BT54R/MTR04/MACADAM 90X
	*In Austria and Switzerland only Bridgestone tires are equipped on this mode.





**MAINTENANCE SPECIFICATIONS**

**ENGINE**

Item	Standard	Limit
Carburetor:		
I.D. mark	5AR 00 (For CH,A)	...
Main jet (M.J)	#142.5	...
Main air jet (M.A.J)	#60	...
Jet needle (J.N)	5E185-2/3	...
Needle jet (N.J)	Y3	...
Pilot air jet 1 (P.A.J.1)	#70	...
Pilot air jet 2 (P.A.J.2)	1.4	...
Pilot outlet (P.O)	0.9	...
Pilot jet (P.J)	#42.5	...
Bypass 1 (B.P.1)	0.8	...
Bypass 2 (B.P.2)	0.9	...
Bypass 3 (B.P.3)	0.8	...
Pilot screw (P.S)	2-1/2	...
Valve seat size (V.S)	1.7	...
Starter jet 1 (G.S.1)	#75	...
Starter jet 2 (G.S.2)	0.8	...
Throttle valve size (Th.V)	#130	...
Fuel level (F.L)	15.8 ~ 16.8 mm	...
Engine idle speed	1,100 ~ 1,200 r/min	...
Intake vacuum	36.0 ~ 38.7 kPa (270 ~ 290 mmHg)	...

**Tightening torques**

Part to be tightened	Part name	Thread size	Q'ty	Tightening torque		Remarks
				Nm	m•kg	
Muffler	Bolt	M10	2	30	3.0	

**CHASSIS**

**Tightening torques**

Part to be tightened	Thread size	Tightening torque		Remarks
		Nm	m•kg	
Rear brake caliper and brake hose joint	M10	30	3.0	

# MAINTENANCE SPECIFICATIONS

**SPEC**

## ELECTRICAL

Item	Standard	Limit
Voltage:	12 V	...
Ignition system:		
Ignition timing (B.T.D.C.)	10° at 1,150 r/min	...
Advancer type	TPS and electrical type	...
Voltage regulator:		
Type	Semi conductor-short circuit type	...
Model/manufacturer	SH650A-12/SHINDENGEN	...
No load regulated voltage	14.1 ~ 14.9 V	...
Electric fan:		
Model/manufacturer	NAAF20/NIPPONDENSO	...

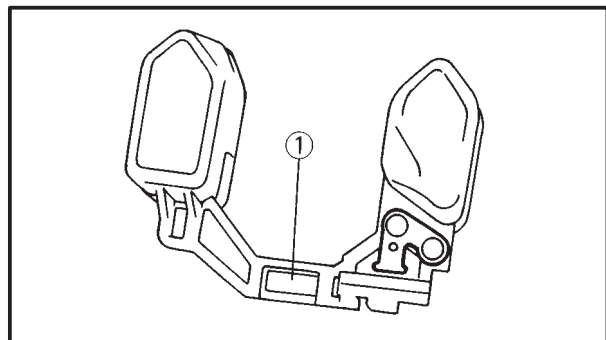
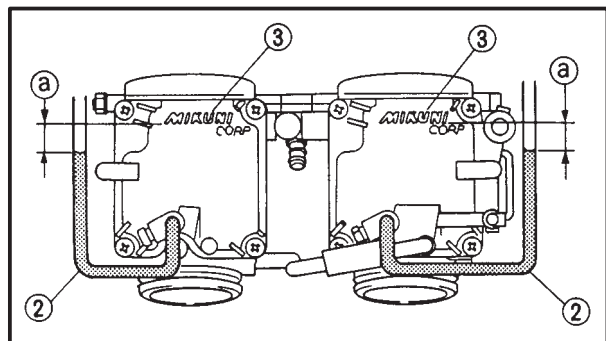

## CARBURETION CARBURETOR

### FUEL LEVEL ADJUSTMENT

1. Measure:
  - Fuel level (a)



Fuel level:

15.8 ~ 16.8 mm  
(below the MIKUNI mark)

Out of specification → Adjust.

### NOTE:

Adjust the float level by slightly bending the float tang (1).

### Fuel level measurement and adjustment steps:

- Place the motorcycle on a level surface.
- Use a garage jack under the engine to ensure that the carburetors are positioned vertically.
- Connect the fuel level gauge (2) to the drain pipe.



Fuel level gauge:  
90890-01312

- Loosen the drain screw.
- Hold the gauge vertically next to the MIKUNI mark (b).
- Measure the fuel level (a) with the gauge.

# TDM850 '97 WIRING DIAGRAM (EXCEPT FOR CH, A)

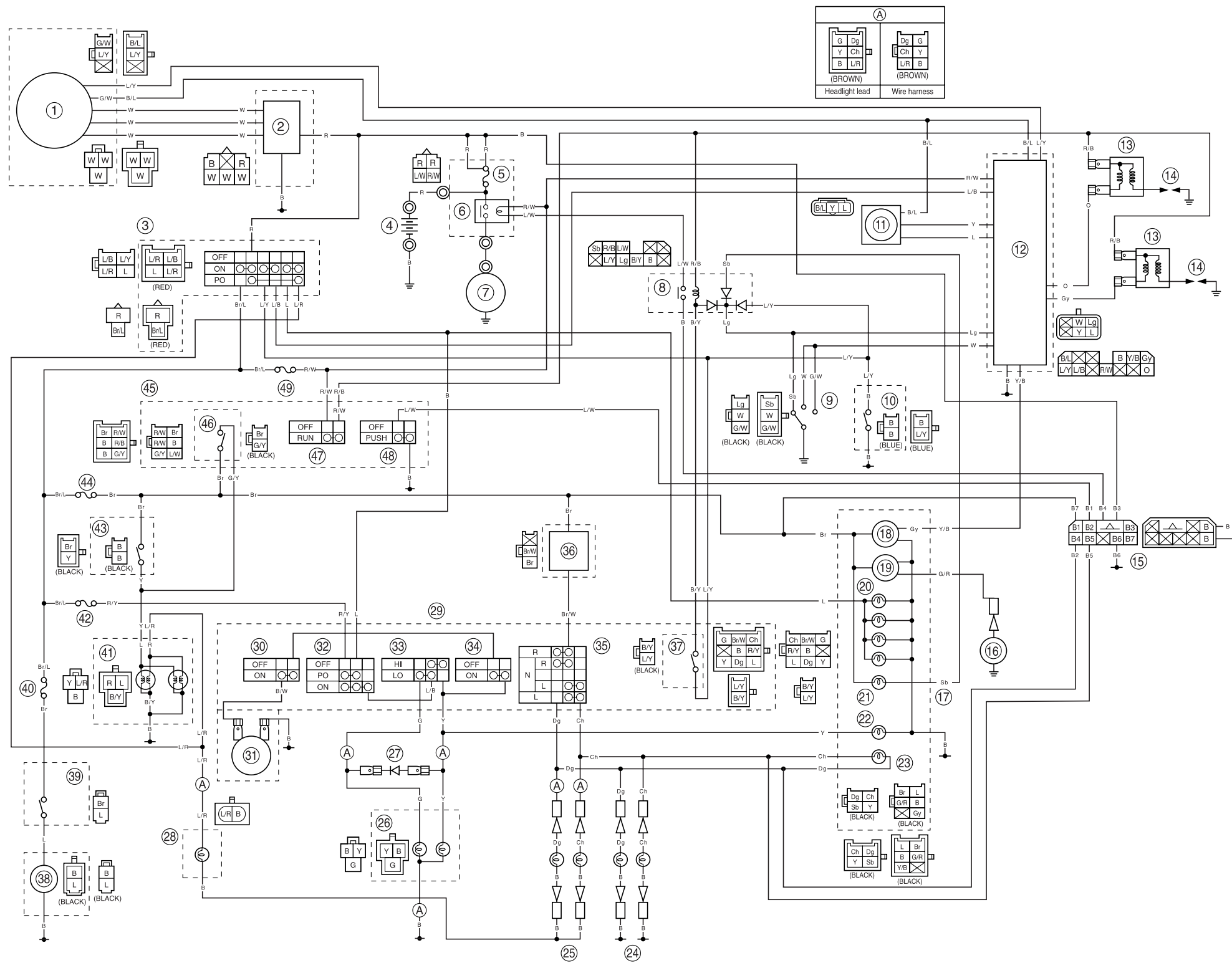

- ① A.C. magneto/pickup coil
- ② Rectifier/regulator
- ③ Main switch
- ④ Battery
- ⑤ Main fuse
- ⑥ Starter relay
- ⑦ Starter motor
- ⑧ Starting circuit cut-off relay
- ⑨ Gear position switch
- ⑩ Sidestand switch
- ⑪ T.P.S. (throttle position sensor)
- ⑫ Ignitor unit
- ⑬ Ignition coil
- ⑭ Spark plug
- ⑮ Accessory coupler
- ⑯ Thermo unit
- ⑰ Meter assembly
- ⑱ Tachometer
- ⑲ Water temperature meter
- ⑳ Meter light
- ㉑ Neutral indicator light
- ㉒ High beam indicator light
- ㉓ Turn indicator light
- ㉔ Rear flasher light
- ㉕ Front flasher light
- ㉖ Headlight
- ㉗ Diode
- ㉘ Auxiliary light
- ㉙ Left handlebar switch
- ㉚ Horn switch
- ㉛ Horn
- ㉜ Lights switch
- ㉝ Dimmer switch
- ㉞ Pass switch
- ㉟ Turn switch
- ㊱ Flasher relay
- ㊲ Clutch switch
- ㊳ Fan motor
- ㊴ Thermo switch
- ㊵ Radiator fan fuse
- ㊶ Tail/brake light
- ㊷ Headlight fuse
- ㊸ Rear brake switch
- ㊹ Signal system fuse
- ㊺ Right handlebar switch
- ㊻ Front brake switch
- ㊼ Engine stop switch
- ㊽ Start switch
- ㊾ Ignition fuse

## COLOR CODE

B . . . . . Black	L . . . . . Blue	Y . . . . . Yellow	Br/W . . Brown/White	L/W . . . Blue/White
Br . . . . . Brown	Lg . . . . . Light green	B/L . . . Black/Blue	G/R . . . Green/Red	L/Y . . . Blue/Yellow
Ch . . . . . Chocolate	O . . . . . Orange	B/R . . . Black/Red	G/W . . . Green/White	R/B . . . Red/Black
Dg . . . . . Dark green	R . . . . . Red	B/W . . . Black/White	G/Y . . . Green/Yellow	R/W . . . Red/White
G . . . . . Green	Sb . . . . . Sky blue	B/Y . . . Black/Yellow	L/B . . . Blue/Black	R/Y . . . Red/Yellow
Gy . . . . . Gray	W . . . . . White	Br/L . . . Brown/Blue	L/R . . . Blue/Red	