

FLUKE®

5725A
Amplifier

Getting Started

PN 1780175
June 2002

© 2002 Fluke Corporation. All rights reserved. Printed in USA
All product names are trademarks of their respective companies.

LIMITED WARRANTY AND LIMITATION OF LIABILITY

Each Fluke product is warranted to be free from defects in material and workmanship under normal use and service. The warranty period is one year and begins on the date of shipment. Parts, product repairs, and services are warranted for 90 days. This warranty extends only to the original buyer or end-user customer of a Fluke authorized reseller, and does not apply to fuses, disposable batteries, or to any product which, in Fluke's opinion, has been misused, altered, neglected, contaminated, or damaged by accident or abnormal conditions of operation or handling. Fluke warrants that software will operate substantially in accordance with its functional specifications for 90 days and that it has been properly recorded on non-defective media. Fluke does not warrant that software will be error free or operate without interruption.

Fluke authorized resellers shall extend this warranty on new and unused products to end-user customers only but have no authority to extend a greater or different warranty on behalf of Fluke. Warranty support is available only if product is purchased through a Fluke authorized sales outlet or Buyer has paid the applicable international price. Fluke reserves the right to invoice Buyer for importation costs of repair/replacement parts when product purchased in one country is submitted for repair in another country.

Fluke's warranty obligation is limited, at Fluke's option, to refund of the purchase price, free of charge repair, or replacement of a defective product which is returned to a Fluke authorized service center within the warranty period.

To obtain warranty service, contact your nearest Fluke authorized service center to obtain return authorization information, then send the product to that service center, with a description of the difficulty, postage and insurance prepaid (FOB Destination). Fluke assumes no risk for damage in transit. Following warranty repair, the product will be returned to Buyer, transportation prepaid (FOB Destination). If Fluke determines that failure was caused by neglect, misuse, contamination, alteration, accident, or abnormal condition of operation or handling, including overvoltage failures caused by use outside the product's specified rating, or normal wear and tear of mechanical components, Fluke will provide an estimate of repair costs and obtain authorization before commencing the work. Following repair, the product will be returned to the Buyer transportation prepaid and the Buyer will be billed for the repair and return transportation charges (FOB Shipping Point).

THIS WARRANTY IS BUYER'S SOLE AND EXCLUSIVE REMEDY AND IS IN LIEU OF ALL OTHER WARRANTIES, EXPRESS OR IMPLIED, INCLUDING BUT NOT LIMITED TO ANY IMPLIED WARRANTY OF MERCHANTABILITY OR FITNESS FOR A PARTICULAR PURPOSE. FLUKE SHALL NOT BE LIABLE FOR ANY SPECIAL, INDIRECT, INCIDENTAL, OR CONSEQUENTIAL DAMAGES OR LOSSES, INCLUDING LOSS OF DATA, ARISING FROM ANY CAUSE OR THEORY.

Since some countries or states do not allow limitation of the term of an implied warranty, or exclusion or limitation of incidental or consequential damages, the limitations and exclusions of this warranty may not apply to every buyer. If any provision of this Warranty is held invalid or unenforceable by a court or other decision-maker of competent jurisdiction, such holding will not affect the validity or enforceability of any other provision.

Fluke Corporation
P.O. Box 9090
Everett, WA 98206-9090
U.S.A.

Fluke Europe B.V.
P.O. Box 1186
5602 BD Eindhoven
The Netherlands

Interference Information

This equipment generates and uses radio frequency energy and if not installed and used in strict accordance with the manufacturer's instructions, may cause interference to radio and television reception. It has been type tested and found to comply with the limits for a Class B computing device in accordance with the specifications of Part 15 of FCC Rules, which are designed to provide reasonable protection against such interference in a residential installation.

Operation is subject to the following two conditions:

- This device may not cause harmful interference.
- This device must accept any interference received, including interference that may cause undesired operation.

There is no guarantee that interference will not occur in a particular installation. If this equipment does cause interference to radio or television reception, which can be determined by turning the equipment off and on, the user is encouraged to try to correct the interference by one of more of the following measures:

- Reorient the receiving antenna
- Relocate the equipment with respect to the receiver
- Move the equipment away from the receiver
- Plug the equipment into a different outlet so that the computer and receiver are on different branch circuits

If necessary, the user should consult the dealer or an experienced radio/television technician for additional suggestions. The user may find the following booklet prepared by the Federal Communications Commission helpful: How to Identify and Resolve Radio-TV Interference Problems. This booklet is available from the U.S. Government Printing Office, Washington, D.C. 20402. Stock No. 004-000-00345-4.

Declaration of the Manufacturer or Importer

We hereby certify that the Fluke Model 5725A Amplifier is in compliance with BMPT Vfg 243/1991 and is RFI suppressed. The normal operation of some equipment (e.g. signal generators) may be subject to specific restrictions. Please observe the notices in the users manual. The marketing and sales of the equipment was reported to the Central Office for Telecommunication Permits (BZT). The right to retest this equipment to verify compliance with the regulation was given to the BZT.

Bescheinigung des Herstellers/Importeurs

Hiermit wird bescheinigt, daß Fluke Models 5725A Amplifier in Übereinstimmung mit den Bestimmungen der BMPT-AmtsblVfg 243/1991 funk-entstört ist. Der vorschriftsmäßige Betrieb mancher Geräte (z.B. Meßsender) kann allerdings gewissen Einschränkungen unterliegen. Beachten Sie deshalb die Hinweise in der Bedienungsanleitung. Dem Bundesamt für Zulassungen in der Telekommunikation wurde das Inverkehrbringen dieses Gerätes angezeigt und die Berechtigung zur Überprüfung der Seire auf Einhaltung der Bestimmungen eingeräumt.

Fluke Corporation

OPERATOR SAFETY SUMMARY

 **WARNING**



HIGH VOLTAGE

is used in the operation of this equipment

LETHAL VOLTAGE

may be present on the terminals, observe all safety precautions!

To avoid electrical shock hazard, the operator should not electrically contact the output hi or sense hi binding posts. During operation, lethal voltages of up to 1100V ac or dc may be present on these terminals.

Whenever the nature of the operation permits, keep one hand away from equipment to reduce the hazard of current flowing through vital organs of the body.

Terms in this Manual

This instrument has been designed and tested in accordance with IEC Publication 348, Safety Requirements for Electronic Measuring Apparatus. This manual contains information and warnings which have to be followed by the user to ensure safe operation and to retain the instrument in safe condition.

⚠ Warning statements identify conditions or practices that could result in personal injury or loss of life.

⚠ Caution statements identify conditions or practices that could result in damage to the equipment or other property.

Symbols Marked on Equipment



DANGER — High Voltage



Protective ground (earth) terminal



Attention — refer to the manual. This symbol indicates that information about the usage of a feature is contained in the manual.

Power Source

The 5725A is intended to operate from a power source that will not apply more than 264V ac rms between the supply conductors or between either supply conductor and ground. A protective ground connection by way of the grounding conductor in the power cord is essential for safe operation.

Use the Proper Fuse

To avoid fire hazard, use only the fuse specified on the line voltage selection switch label, and which is identical in type voltage rating, and current rating.

Grounding the 5725A

The 5725A is Safety Class I (grounded enclosure) instruments as defined in IEC 348. The enclosure is grounded through the grounding conductor of the power cord. To avoid electrical shock, plug the power cord into a properly wired earth grounded receptacle before connecting anything to any of the 5725A or 5700A terminals. A protective ground connection by way of the grounding conductor in the power cord is essential for safe operation.

Use the Proper Power Cord

Use only the power cord and connector appropriate for proper operation of a 5725A in your country.

Use only a power cord that is in good condition.

Refer cord and connector changes to qualified service personnel.

Do Not Operate in Explosive Atmospheres

To avoid explosion, do not operate the 5725A in an atmosphere of explosive gas.

Do Not Remove Cover

To avoid personal injury or death, do not remove the 5725A cover. Do not operate the 5725A without the cover properly installed. There are no user-serviceable parts inside the 5725A, so there is no need for the operator to ever remove the cover.

Do Not Attempt to Operate if Protection May be Impaired

If the 5725A appears damaged or operates abnormally, protection may be impaired. Do not attempt to operate it. When in doubt, have the instrument serviced.

SERVICING SAFETY SUMMARY

FOR QUALIFIED SERVICE PERSONNEL ONLY

Also refer to the preceding Operator Safety Summary

Do Not Service Alone

Do not perform internal service or adjustment of this product unless another person capable of rendering first aid and resuscitation is present.

Use Care When Servicing With Power On

Dangerous voltage exist at many points inside this product. To avoid personal injury, do not touch exposed connections and components while power is on.

Whenever the nature of the operation permits, keep one hand away from equipment to reduce the hazard of current flowing through vital organs of the body.

Do not wear a grounded wrist strap while working on this product. A grounded wrist strap increase the risk of current flowing through the body.

Disconnect power before removing protective panels, soldering, or replacing components.

High voltage may still be present even after disconnecting power.



FIRST AID FOR ELECTRIC SHOCK

Free the Victim From the Live Conductor

Shut off high voltage at once and ground the circuit. If high voltage cannot be turned off quickly, ground the circuit.

If the circuit cannot be broken or grounded, use a board, dry clothing, or other nonconductor to free the victim.

Get Help!

Yell for help. Call an emergency number. Request medical assistance.

Never Accept Ordinary and General Tests for Death

Symptoms of electric shock may include unconsciousness, failure to breathe, absence of pulse, pallor, and stiffness, and well as severe burns.

Treat the Victim

If the victim is not breathing, begin CPR or mouth-to-mouth resuscitation if you are certified.

Table of Contents

Title	Page
Introduction.....	1
Contacting Fluke	2
Where to Go From Here	2
How to Use the Manuals	4
5725A Getting Started Manual	4
5725A Instruction Manual.....	4
5700A/5720A Series II Manual Set.....	4
5700A/5720A Series II Operator Manual	4
5700A/5720A Series II Operator Reference Guide.....	5
5700A/5720A Series II Remote Programming Reference Guide.....	5
5700A/5720A Series II Service Manual	5
General Specifications.....	6
Unpacking and Inspection	8
Service Information	11
Placement and Rack Mounting.....	11
Cooling Considerations	12
Connecting to the 5700A Calibrator	12

Selecting Line Voltage	14
Accessing the Fuse.....	16
Connecting to Line Power	18
Front-Panel Features	18
Rear-Panel Features.....	22
Turning on the 5725A Amplifier.....	25
Warm Up.....	25

List of Tables

Table	Title	Page
1.	Standard Equipment.....	8
2.	Line Power Cord Types Available from Fluke.....	9
3.	Front-Panel Features.....	20
4.	Rear-Panel Features	23

List of Figures

Figure	Title	Page
1.	5700A Dimensions	7
2.	Line Power Cords Available for Fluke Instruments	10
3.	Correct Way to Dress Interface Cable	13
4.	Line Power Label and Switch Location	15
5.	Accessing the Fuse	17
6.	Front-Panel Features	19
7.	Rear-Panel Features	22

Getting Started

Introduction

The Fluke 5725A Amplifier enhances the 5700A Calibrator in the ac voltage, ac current, and dc current functions. The 5725A operates under complete control of the 5700A through an interface cable supplied with the 5725A.

Figure 1 illustrates the extended ac volt-hertz product achieved by using a 5725A. Increased ac voltage load limits allow using the 5700A Calibrator in systems with long cables.

Voltage output from the 5725A is available at the 5700A Calibrator front or rear binding posts. This eliminates the need to move cables during a procedure that requires amplified as well as standard calibrator outputs.

The 5725A front or rear-panel OUTPUT binding posts are only for current output. Extended-range ac and dc current

is supplied through them. Since most meters with a high-current range use a separate high-current input terminal, this configuration normally eliminates the need to move cables during a procedure. If a single-point current output is needed, the 5700A Calibrator can be configured to source all current outputs through the 5725A binding posts.

Enhancements to 5700A ac voltage output capability provided by the 5725A are as follows:

- Frequency limits at higher voltage increase to 100 kHz at 750V, 30 kHz at 1100V.
- Load limits are to 70 mA for frequencies above 5 kHz, and to 50 mA for frequencies less than 5 kHz.
- Capacitive load limits are increased to 1000 pF.

Model 5725A operating functions and ranges are as follows:

5725A

Amplifier

- AC voltage: 220 to 1100V rms up to 70 mA (50 mA < 5 kHz), 40 Hz to 30 kHz; 220 to 750V rms up to 70 mA, 30 kHz to 100 kHz
- DC current: 0 to ± 11 A
- AC current: 1 to 11A rms, 40 Hz to 10 kHz

Contacting Fluke

To contact Fluke, call one of the following telephone numbers:

USA: 1-888-99-FLUKE (1-888-993-5853)

Canada: 1-800-36-FLUKE (1-800-363-5853)

Europe: +31 402-678-200

Japan: +81-3-3434-0181

Singapore: +65-738-5655

Anywhere in the world +1-425-446-5500

Or, visit Fluke's web site at www.fluke.com.

Where to Go From Here

The 5725A Instruction Manual (provided on the CD-ROM) contains both operating and service information for the 5725A. However, because the 5725A operates under the control of the 5700A Calibrator, most operating instructions for the 5725A are in the 5700A/5720A Series II manuals. Topics such as selecting output values, connecting to a UUT (Unit Under Test), and self calibration are covered in the 5700A/5720A Series II Operator Manual. The list below gives some specific pointers, and the text further on describes how to use all the manuals to find 5725A information.

For More Information About:	Refer To:
Unpacking and setup	this manual
Installation and rack mounting	this manual
AC line power and interface cabling	this manual
Controls, indicators, and binding posts	this manual
5725A service information	Chapters 4 through 9 of the Instruction Manual
Operating the amplifier	Chapter 3 of of the Instruction Manual
Cabling to a Unit Under Test	Chapter 4 of the 5700A/5720A Series II Operator Manual
Self calibration	Chapter 7 of the 5700A/5720A Series II Operator Manual
Full verification	Chapter 3 of the 5700A/5720A Series II Service Manual
IEEE-488 or serial remote operation	Chapter 5 of the 5700A/5720A Series II Operator Manual
5700A/5725A specifications	Chapter 1 of the 5725A Instruction Manual
Theory of operation	Chapter 4 and 9 of the 5725A Instruction Manual
Troubleshooting	Chapter 6 of the 5725A Instruction Manual
Ordering a part	Chapter 8 of the 5725A Instruction Manual

How to Use the Manuals

The following paragraphs describe how each manual addresses the 5725A.

5725A Getting Started Manual

Use this manual for basic getting started information, contacting Fluke, unpacking, and general specifications. This manual also provides setup and operation information for the 5725A Amplifier, descriptions of the 5725A front and rear-panel features, and information about setting up and powering up the 5725A. Please read this information before operating the amplifier.

5725A Instruction Manual

Use the 5725A Instruction Manual for installing the 5725A, learning about its front and rear-panel features, and for all service-related topics such as maintenance, troubleshooting, parts lists, and schematics. (The 5725A Instruction Manual is the service and operator manual for the 5725A.)

Although the instruction manual also contains a section devoted to 5725A operating notes, once the 5725A is up and running you will find that the 5700A/5720A Operator Manual contains most of the information you need to operate the 5725A.

5700A/5720A Series II Manual Set

The 5700A/5720A Series II Manual Set consists of a Getting Started Manual, an Operator Reference Guide, a Remote Programming Reference Guide and a CD-ROM containing an Operators Manual and Service Manual (in addition to all the other manuals provided in printed form).

5700A/5720A Series II Operator Manual

The 5700A/5720A Series II Operator Manual contains the following information pertaining to the 5725A:

- Specifications for both the 5700A and 5725A (these same specifications are in this Instruction Manual)
- Cable connections to a UUT for amplified voltage and current
- Front panel (local) operation
- Remote control operation, IEEE-488 or RS-232
- Self calibration
- Fault codes (these appear on the 5700A Control Display, or are read from the 5700A in remote control operation)
- Calibration constant symbolic names
- Glossary of calibration-related terms

5700A/5720A Series II Operator Reference Guide

The 5700A/5720A Series II Operator Reference Guide contains a summary of operating instructions from the Operator Manual. This booklet contains information needed to start up and operate the 5700A, but since the 5700A controls the 5725A, much of this information applies to the 5725A.

5700A/5720A Series II Remote Programming Reference Guide

The 5700A/5720A Series II Remote Programming Reference Guide contains a summary of remote commands for the 5700A. It also contains information needed to determine system status using the status byte and registers. Remote commands and system status apply to a 5725A under control of the 5700A.

5700A/5720A Series II Service Manual

The 5700A/5720A Series II Service Manual is a maintenance guide for the 5700A. The following 5725A topics are included in the 5700A/5720A Series II Service Manual:

- Specifications for both the 5700A and 5725A
- Full verification of the 5700A and 5725A (recommended every two years)
- Calibration of the 5700A and 5725A

General Specifications

Warm-Up time: 2 X the time since last warmed up, to a maximum of 30 minutes.

System installation: Rear output configuration and rack- mount kit available.

Standard interfaces: IEEE-488, RS-232, 5725A, 5205A or 5215A, 5220A, phase lock in (BNC), phase reference out (BNC).

Temperature performance: Operating: 0 °C to 50 °C. Calibration: 15 °C to 35 °C. Storage: -40 °C to 75 °C.

Relative humidity: Operating: <80 % to 30 °C, <70 % to 40 °C, <40 % to 50 °C. Storage: <95 %, non-condensing.

Safety: Designed to comply with UL1244 (1987); IEC 348-1978; IEC 66E (CO) 4; CSA 556B.

Guard isolation: 20 volts

EMI/RFI: Designed to comply with FCC Rules Part 15, Subpart J, Class B; VDE 0871, Class B.

Reliability: MIL-T-28800D, para. 3.13.3.

Line Power: 47 to 63 Hz; ± 10 % allowed about selectable nominal line voltage: 100V, 110V, 115V, 120V, 200V, 220V, 230V, 240V. Maximum power: 5700A, 300 VA; 5725A, 750 VA.

Electromagnetic Compatibility: This instrument is designed to operate in Standards Laboratory environments where in electromagnetic is highly controlled. If used in areas with RF fields >0.78 V/m there could be errors in measurements.

Size:

5700A: Height 17.8 cm (7 in), standard rack increment, plus 1.5 cm (0.6 in) for feet; Width 43.2 cm (17 in), standard rack width; Depth 63.0 cm (24.8 in), overall; 57.8 cm (22.7 in), rack depth.

5725A: Height 13.3 cm, (5.25 in); Width and depth same as 5700A. Both units project 5.1 cm, (2 in) from rack front.

Weight: 5700A: 27 kg (62 lbs); 5725A: 32 kg (70 lbs).

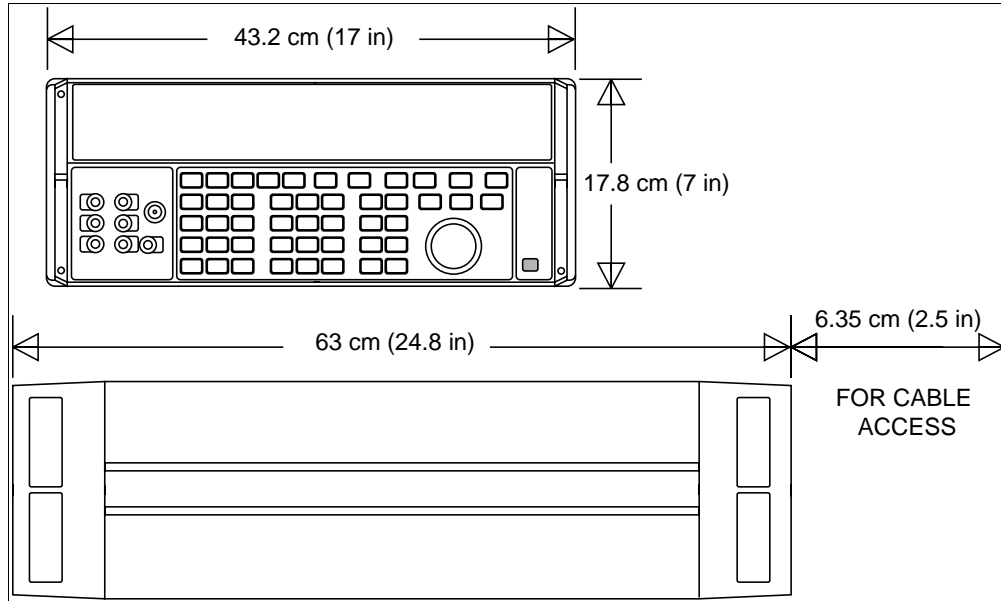

Figure 1. 5700A Dimensions

Unpacking and Inspection



The 5725A amplifier is capable of supplying lethal voltages. Do not touch the 5700A output terminals. Read this section before operating the 5725A.

The 5725A is shipped in a container that is specially designed to prevent damage during shipping. Inspect the 5725A carefully for damage, and immediately report any damage to the shipper. Instructions for inspection and claims are included in the shipping container.

If you need to reship the 5725A, use the original container. If it is not available, you can order a new container from Fluke by identifying the amplifier's model and serial number.

When you unpack the 5725A, check for all the standard equipment listed in Table 1. Report any shortage to the place of purchase or to the nearest Technical Service Center. Visit Fluke web site for Service Center locations. If performance tests are required for your acceptance procedures, refer to Chapter 3 of the 5700A/5720A Series II Service Manual for instructions.

Line power cords available from Fluke are listed in Table 2 and illustrated in Figure 2.

Table 1. Standard Equipment

Item	Model or Part Number
Amplifier	5725A
Line Power Cord	(See Table 2 and Figure 2)
Shielded 5700A/5725A Interface Cable	842901
5725A Getting Started Manual	1780175
5725A CD-ROM (contains Instruction Manual)	1780182
Spare 4A, 250V Fuse	216846
Certificate of Calibration	(No Part Number)

Table 2. Line Power Cord Types Available from Fluke

TYPE	VOLTAGE/CURRENT	FLUKE OPTION NUMBER
North America	120V/15A	LC-1
North America	240V/15A	LC-2
Universal Euro	220V/16A	LC-3
United Kingdom	240V/13A	LC-4
Switzerland	220V/10A	LC-5
Australia	240V/10A	LC-6
South Africa	240V/5A	LC-7

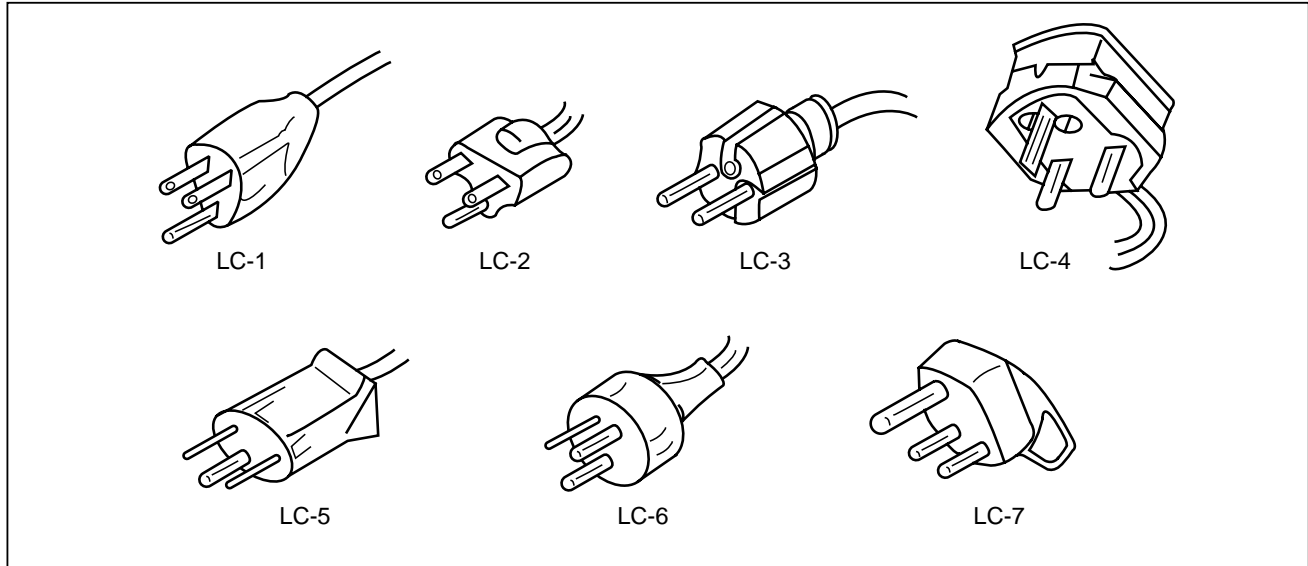

Figure 2. Line Power Cords Available for Fluke Instruments

aq2f.eps

Service Information

Each 5725A Amplifier is warranted to the original purchaser for a period of one year beginning on the date received. The warranty is located at the front of this manual.

Factory-authorized service and technical advice for the 5725A is available at Fluke Service Centers. A complete list of service centers is available at www.fluke.com.

Warning

Servicing described in this manual is to be done by qualified service personnel only. To avoid electrical shock, do not service the 5725A unless you are qualified to do so.

The owner may choose to repair a 5725A using the troubleshooting information in Chapter 7 of the Instruction Manual to isolate a faulty module, then use the Module Exchange Program. Refer to the Fluke catalog or contact a Service Center representative for the module exchange procedure.

Placement and Rack Mounting

You can stack the 5725A on top of or below the 5700A Calibrator. (Choose the configuration that provides the easiest access to the 5700A Calibrator controls.) Or, you can mount the 5725A in a standard-width, 24-inch (61-cm) deep equipment rack. For bench-top stacking, the 5725A is equipped with non-skid feet. To mount the 5725A in an equipment rack, order the accessory 5725A Rack Mount Kit, Model Y5735. An instruction sheet is packed with the kit.

Caution

Use only the rack mount slides included in the Y5735 kit. Rack mount slides intended for other instruments can block the side ventilation holes on the 5725A and cause overheating.

Cooling Considerations



Damage caused by overheating may occur if the area around the air intake is restricted, the intake air is too warm, or the fan filter becomes clogged.

Accuracy and dependability of all internal parts of the 5725A are enhanced by maintaining the coolest possible internal temperature. By observing the following rules you can lengthen the life of the 5725A:

- The area around the fan filter must be at least 3 inches from nearby walls or rack enclosures.
- Exhaust perforations on the sides of the 5725A must be clear of obstructions. Most of the heat exits from the side vents near the front.
- Air entering the instrument must be room temperature. Make sure that exhaust from another instrument is not directed into the fan inlet.
- Clean the fan filter every 30 days, or more frequently if the 5725A is operated in a dusty environment. (Instructions for cleaning the fan filter are in Chapter 6.)

Connecting to the 5700A Calibrator

Proceed as follows to connect the 5725A to the 5700A:

1. Turn the power off for both instruments and disconnect their line power cords.
2. Connect either end of the interface cable to the 5725A connector labeled 5700A. Dress the cable only as Figure 3 shows. The figure shows how to dress the cable in installation arrangements with the 5725A on top or bottom.
3. Connect the other end to the 5700A connector labeled 5725A.

The 5700A/5725A interface cable provides all the digital and analog control signals for the amplifier, and it provides conductors to route amplified voltage to the 5700A OUTPUT binding posts.

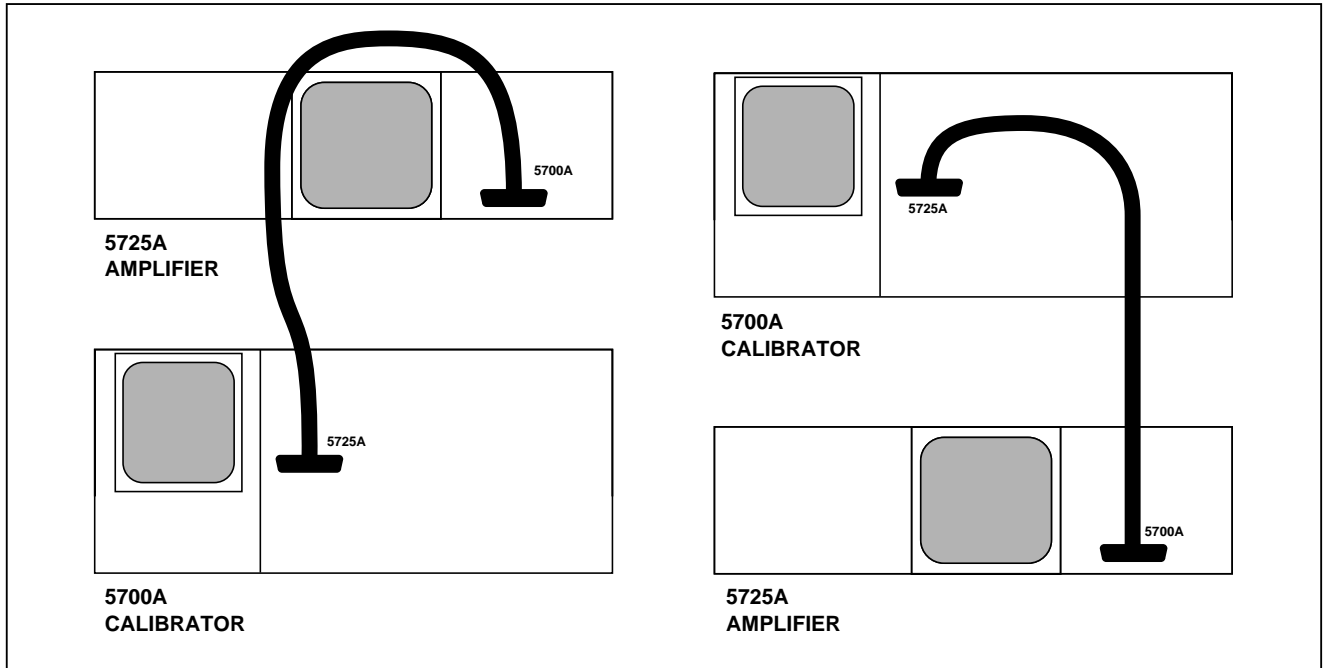

Figure 3. Correct Way to Dress Interface Cable

aq3f.eps

Selecting Line Voltage

The 5725A arrives from the factory configured for the line voltage normally appropriate for the country of purchase, or as specified at the time of purchase. Check the line power label on the rear panel of the 5725A to verify that the line voltage matches local line power. Figure 4 shows the location of the line power label and switches, and the switch settings for each line voltage.

The 5725A can be set to operate from eight different nominal line voltages; each voltage setting has a voltage tolerance of $\pm 10\%$ and a frequency range of 47 to 63 Hz. The line voltage switches are located on the bottom left side of the rear panel.

To change the line voltage setting, set the line voltage selection switches to the correct setting shown in Figure 4.

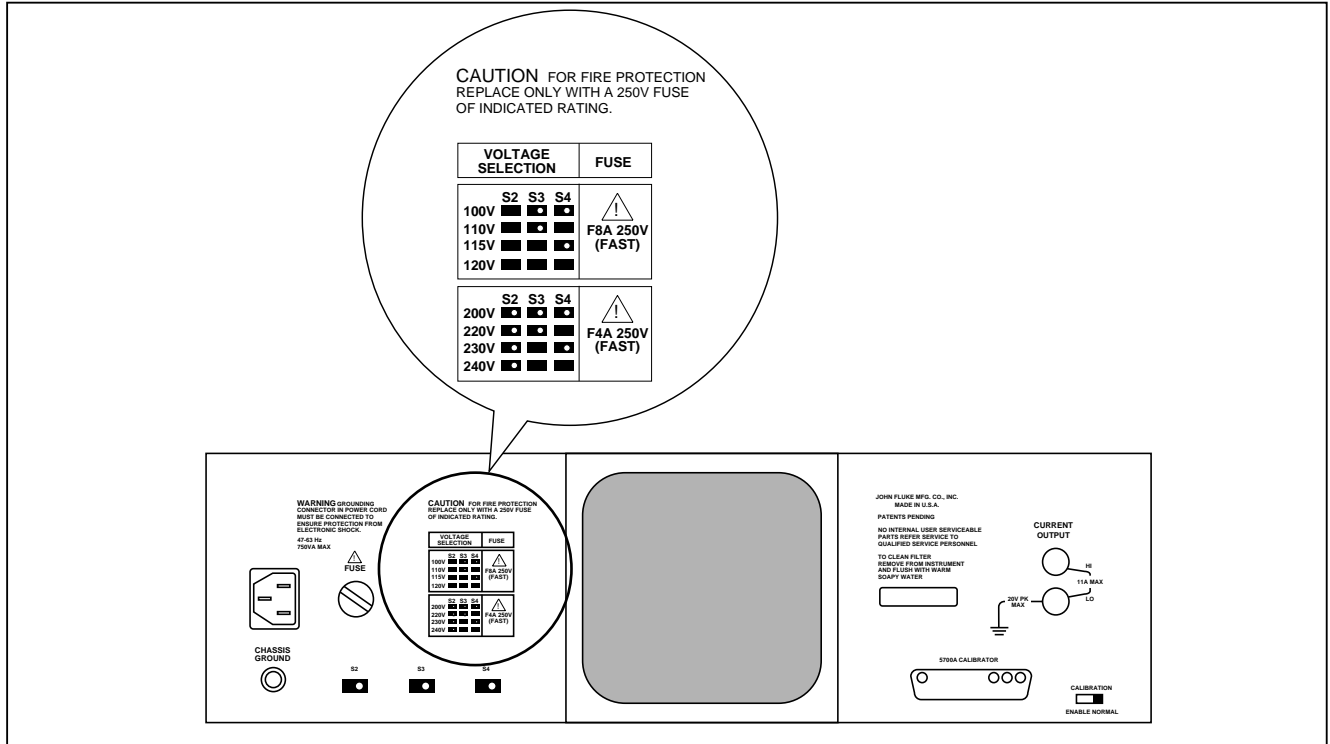

Figure 4. Line Power Label and Switch Location

aq4f.eps

Accessing the Fuse



To prevent instrument damage, verify that the correct fuse is installed for the line voltage setting. Acceptable fuse types are Bussman type MTH or Littelfuse type 312 or equivalent, of the appropriate amperage rating. Use only a 4A, 250V fast-blow fuse when the line voltage selection switches are set in the range 200-240V.

Note

A spare 4A, 250V fuse is shipped with the 5725A to ensure that one is available for use on the 200-240V range.

The line power fuse is accessible on the rear panel. The fuse rating label to the right of the fuse holder (labeled FUSE) shows the correct replacement fuse rating for each line voltage setting. To check or replace the fuse, refer to Figure 5 and proceed as follows:

1. Turn off the POWER switch and disconnect the line power cord from ac line power.
2. Insert the blade of a standard screwdriver in the slot of the fuse holder labeled FUSE.
3. Turn the screwdriver counterclockwise until the cap and fuse pop free.
4. To reinstall the fuse, reverse this procedure.

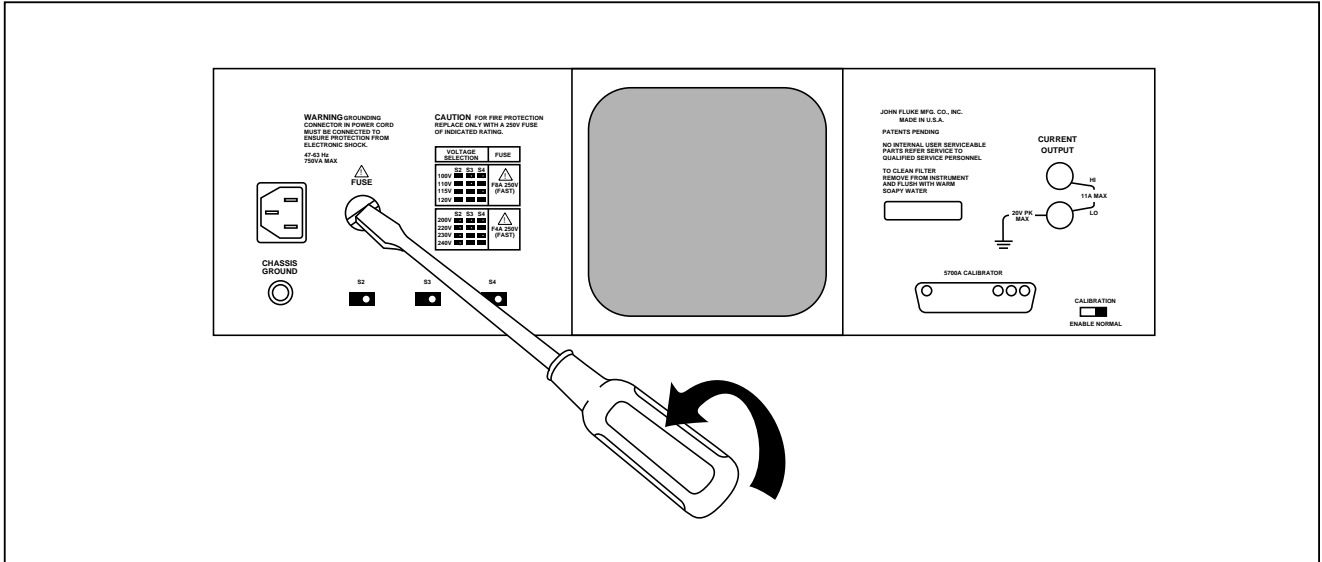

Figure 5. Accessing the Fuse

aq5f.eps

Connecting to Line Power

Warning

To avoid shock hazard, connect the factory-supplied, three-conductor line power cord to a properly grounded power outlet. Do not use a two-conductor adapter or extension cord; this will break the protective ground connection.

After verifying that the line voltage selection switches are correctly set, verify that the correct fuse is installed. Connect the 5725A to a properly grounded three-prong outlet.

Front-Panel Features

Front-panel features are called out in Figure 6 and are described in Table 3.

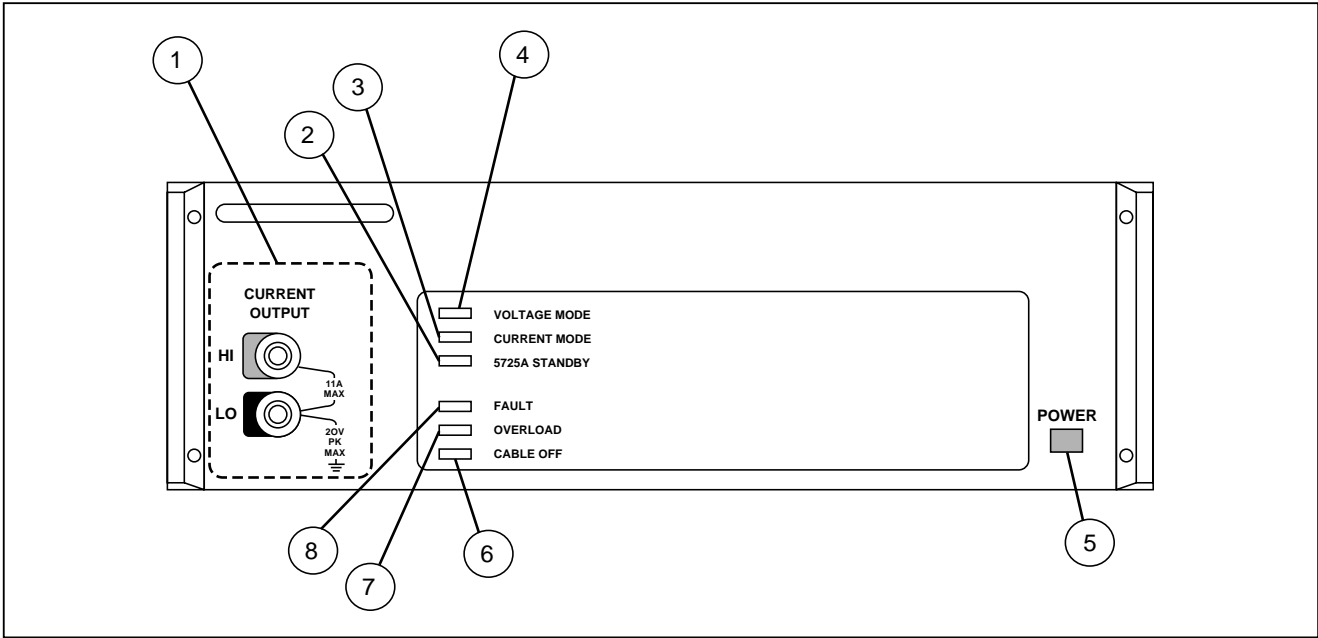

Figure 6. Front-Panel Features

aq6f.eps

Table 3. Front-Panel Features

①

CURRENT OUTPUT Binding Posts

The source of all amplified current if the 5725A is configured for front output. You can set the 5700A to source all unamplified as well as amplified current through these binding posts. The LO binding post is isolated from ground when in the current function, and is open-circuited at other times. Cable and connection recommendations are made in Chapter 4 of the 5700A/5720A Series II Operator Manual.

②

5725A STANDBY Indicator

Lit whenever the 5725A is in any of three standby modes. This indicator is lit alone in standby mode; it is lit at the same time as VOLTAGE MODE in voltage standby mode; and it is lit at the same time as CURRENT MODE in current standby mode. (See "5725A Operating Functions and Modes," in Chapter 3 of the Instruction Manual.)

③

CURRENT MODE Indicator

Lit when the 5725A is in current standby or current operate mode. In current standby mode, the STANDBY indicator is also lit. (See "5725A Operating Functions and Modes," in Chapter 3 of the Instruction Manual.)

④

VOLTAGE MODE Indicator

Lit when the 5725A is in voltage standby or voltage operate mode. In voltage standby mode, the STANDBY indicator is also lit. (See "5725A Operating Functions and Modes," in Chapter 3 of the Instruction Manual.)

⑤ **POWER Switch**

Turns the power on and off. The switch is a push-push type; the first push turns the power on and locks the switch in, and the second push turns the power off and releases the switch.

⑥ **CABLE OFF Indicator**

Lit when the 5700A/5725A interface cable is not connected, or when the 5700A power is turned off. This condition also lights the FAULT indicator.

⑦ **OVERLOAD Indicator**

Lights on entering current operate mode in overcompliance conditions (load not connected to the proper binding posts, or load resistance too high). The OVERLOAD indicator also lights on entering voltage operate mode if the load resistance is too low.

⑧ **FAULT Indicator**

Lit whenever any fault condition is detected. Normally, a fault code and message appears on the 5700A Control Display when this happens. The FAULT indicator also comes on with the CABLE OFF indicator when the 5700A/5725A interface cable is not connected. In case of a FAULT indication, check the 5700A/5725A interface cable connections, make sure the 5700A power is on, and check that the load is appropriate and connected to the correct binding posts. Refer to the Instruction Manual under "Service Information" in Chapter 2, or in Chapter 7, Troubleshooting, in case of a FAULT indication that appears to be a malfunction.

Rear-Panel Features

Rear-panel features are called out in Figure 7 and briefly described in Table 4.

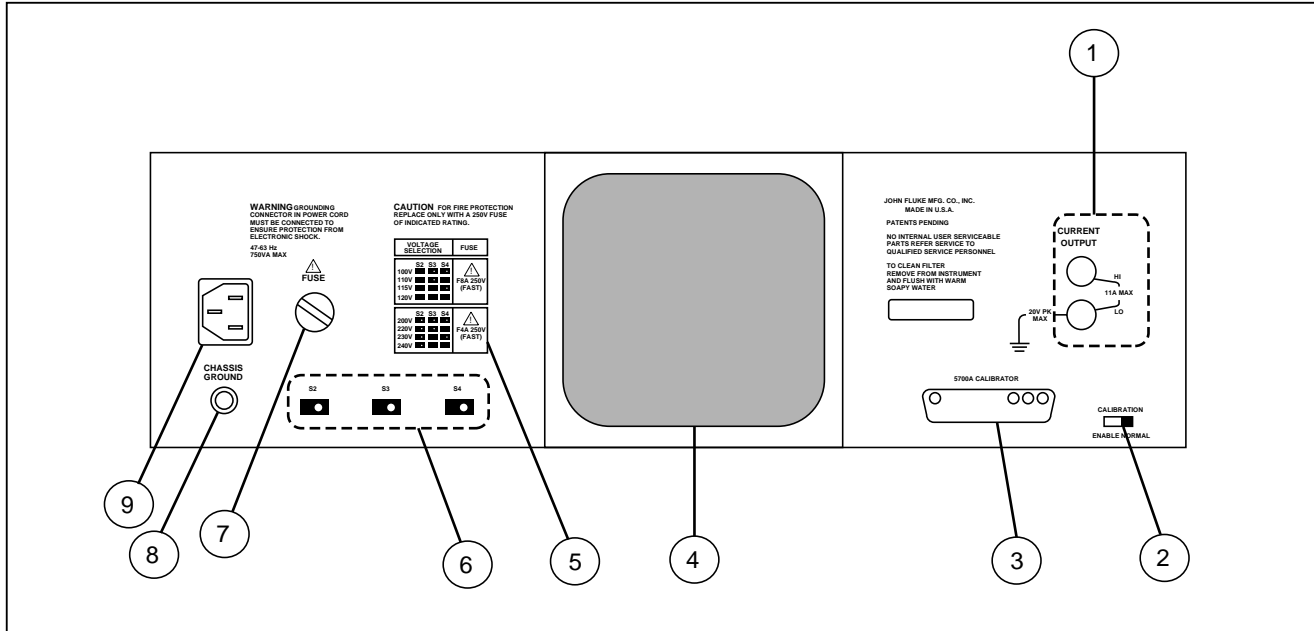

Figure 7. Rear-Panel Features

aq7f.eps

Table 4. Rear-Panel Features

①

CURRENT OUTPUT Binding Posts

The source of all amplified current if the 5725A is configured for rear output. You can set the 5700A to source all its unamplified as well as amplified current through these binding posts. The LO binding post is isolated from ground when in the current function, and is open-circuited at other times. Cable and connection recommendations are made in Chapter 4 of the 5700A/5720A Series II Operator Manual.

②

CALIBRATION Switch

A slide switch that enables and disables writing to the nonvolatile memory that stores 5725A calibration constants. Switching to ENABLE allows writing to the memory, and switching to NORMAL protects data in memory from being overwritten. The switch must be in the ENABLE position to store corrections generated during calibration. The switch is recessed to allow a metrologist to cover it with a calibration seal to guarantee calibrator integrity.

③

5700A CALIBRATOR Connector

Provides the analog and digital interface to the 5700A Calibrator. After connecting to the 5700A, you control the 5725A from the 5700A front panel or by sending remote commands to the 5700A. Refer to "Using an Auxiliary Amplifier" in Chapter 4 of the Instruction Manual, or for remote operation to Chapter 5, of the 5700A/5720A Series II Operator Manual for details.

④

Fan Filter

Covers the air intake to keep dust and debris out of the instrument. The fan directs a constant cooling air flow throughout the chassis.

⑤ **Line Voltage/Fuse Rating Label**

Shows the various settings of the line voltage switches, and the correct replacement fuse for operating voltages of 110 (90 to 132) and 220 (180 to 264) volts ac. Refer to "Accessing the Fuse" for the fuse replacement procedure.

⑥ **Line Voltage Selection Switches**

Select the operating line voltage. Refer to "Selecting Line Voltage" for instructions on how to select operating line voltage.

⑦ **Fuse Holder**

The line power fuse. Refer to "Accessing the Fuse" for fuse rating information and the fuse replacement procedure.

⑧ **CHASSIS GROUND Connector**

If the 5725A is the location of the ground reference point in a system, the CHASSIS GROUND binding post can be used for connecting other instruments to earth ground. (The chassis is connected to earth ground through the three-conductor line cord.)

⑨ **Line Power Input**

A grounded male three-prong connector that accepts the line power cord.

Turning on the 5725A Amplifier

Warning

To avoid electric shock, make sure the 5725A is safely grounded as described in Chapter 2 of the Instruction Manual.

Caution

Before turning the 5725A on, make sure that the line voltage selection switches are set properly for your line voltage. Refer to Figure 4 or the line voltage switch label and check the line voltage setting now if you have not already done so.

When you turn on the 5725A, all six front-panel indicators light briefly and the 5725A undergoes a self test. If the self test fails, a fault message on the 5700A Control Display identifies the failure, indicating that you should service the 5725A.

After the 5725A passes its self test, it transfers its calibration constants to the 5700A. During the transfer, the BOOST indicator on the 5700A flashes. For the few seconds that the BOOST indicator is flashing, the 5725A is not usable. After the transfer is complete, the 5725A is in standby mode. (See "5725A Operating Functions and Modes" in Chapter 3 of the Instruction Manual for more information about standby mode.)

Warm Up

When you turn on a cold 5725A, warm it up for 30 minutes to allow the components inside to stabilize. This ensures that the 5725A meets or exceeds the specifications.

If you turn off the 5725A after it has warmed up, allow it to warm up again for at least twice the length of time it was turned off (up to a maximum of 30 minutes of warm-up). For example, if the 5725A is turned off for 10 minutes, allow it to warm up again for at least 20 minutes.

