

Revision C:

• MSZ-SF25/35/42/50VE- **ER2** have been added.

Please void OBH600 REVISED EDITION-B.

INDOOR UNIT SERVICE MANUAL

**No. OBH600
REVISED EDITION-C**

Models

MSZ-SF25VE - **E1**, **E2**, **EN1**, **EN2**, **ER2**

MSZ-SF35VE - **E1**, **E2**, **EN1**, **EN2**, **ER2**

MSZ-SF42VE - **E1**, **E2**, **EN1**, **EN2**, **ER2**

MSZ-SF50VE - **E1**, **E2**, **EN1**, **EN2**, **ER2**

Outdoor unit service manual
MUZ-SF-VE(H) Series (OBH629)
MXZ-C-VA Series (OB584)
MXZ-D-VA Series (OBH626)
MXZ-8B Series (OCH480)

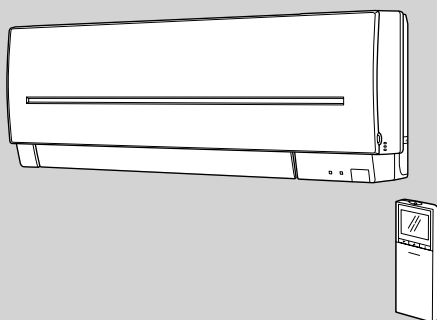

CONTENTS

1. TECHNICAL CHANGES	3
2. PART NAMES AND FUNCTIONS.....	4
3. SPECIFICATION.....	5
4. NOISE CRITERIA CURVES	6
5. OUTLINES AND DIMENSIONS	7
6. WIRING DIAGRAM.....	8
7. REFRIGERANT SYSTEM DIAGRAM	10
8. SERVICE FUNCTIONS	11
9. MICROPROCESSOR CONTROL	13
10. TROUBLESHOOTING.....	19
11. DISASSEMBLY INSTRUCTIONS.....	32

PARTS CATALOG (OBB600)

NOTE:

RoHS compliant products have <G> mark on the spec name plate.



Use the specified refrigerant only

Never use any refrigerant other than that specified.

Doing so may cause a burst, an explosion, or fire when the unit is being used, serviced, or disposed of.

Correct refrigerant is specified in the manuals and on the spec labels provided with our products.

We will not be held responsible for mechanical failure, system malfunction, unit breakdown or accidents caused by failure to follow the instructions.

<Preparation before the repair service>

- Prepare the proper tools.
- Prepare the proper protectors.
- Provide adequate ventilation.
- After stopping the operation of the air conditioner, turn off the power-supply breaker and remove the power plug.
- Discharge the capacitor before the work involving the electric parts.

<Precautions during the repair service>

- Do not perform the work involving the electric parts with wet hands.
- Do not pour water into the electric parts.
- Do not touch the refrigerant.
- Do not touch the hot or cold areas in the refrigeration cycle.
- When the repair or the inspection of the circuit needs to be done without turning off the power, exercise great caution not to touch the live parts.

Revision A:

- MSZ-SF25/35/42/50VE-  and MSZ-SF25/35/42/50VE-  have been added.

Revision B:

- "How to check miswiring and serial signal error" for MUZ type has been added.
- The description about "Low standby power control" has been added to "TECHNICAL CHANGES".

Revision C:

- MSZ-SF25/35/42/50VE-  have been added.

1

TECHNICAL CHANGES

MSZ-SF25VE-^{E1} **MSZ-SF25VE-^{EN1}**

MSZ-SF35VE-^{E1} **MSZ-SF35VE-^{EN1}**

MSZ-SF42VE-^{E1} **MSZ-SF42VE-^{EN1}**

MSZ-SF50VE-^{E1} **MSZ-SF50VE-^{EN1}**

1. New model

MSZ-SF25VE-^{E1} → **MSZ-SF25VE-^{E2}** **MSZ-SF25VE-^{EN1}** → **MSZ-SF25VE-^{EN2}**

MSZ-SF35VE-^{E1} → **MSZ-SF35VE-^{E2}** **MSZ-SF35VE-^{EN1}** → **MSZ-SF35VE-^{EN2}**

MSZ-SF42VE-^{E1} → **MSZ-SF42VE-^{E2}** **MSZ-SF42VE-^{EN1}** → **MSZ-SF42VE-^{EN2}**

MSZ-SF50VE-^{E1} → **MSZ-SF50VE-^{E2}** **MSZ-SF50VE-^{EN1}** → **MSZ-SF50VE-^{EN2}**

1. Indoor electronic control P.C. board has been changed.

^{E2} and ^{EN2} models are compatible with the outdoor units with low standby power control.

Connecting these models to the MUZ-SF·VE(H)-series outdoor units enables the low standby power control. Refer to the technical guide (OBT17) about the low standby power control.

These models may be connected to the MUZ-SF·VE(H) series after once connected to the MXZ series and operated, for example because of relocation. In that case, the MUZ-SF·VE(H) series outdoor units will not operate without taking a step. Follow the procedure "Deleting the memorized abnormal condition" described in 10-2.1.

MSZ-SF25VE-^{ER2}

MSZ-SF35VE-^{ER2}

MSZ-SF42VE-^{ER2}

MSZ-SF50VE-^{ER2}

1. New model

2

PART NAMES AND FUNCTIONS

MSZ-SF25VE MSZ-SF35VE MSZ-SF42VE MSZ-SF50VE

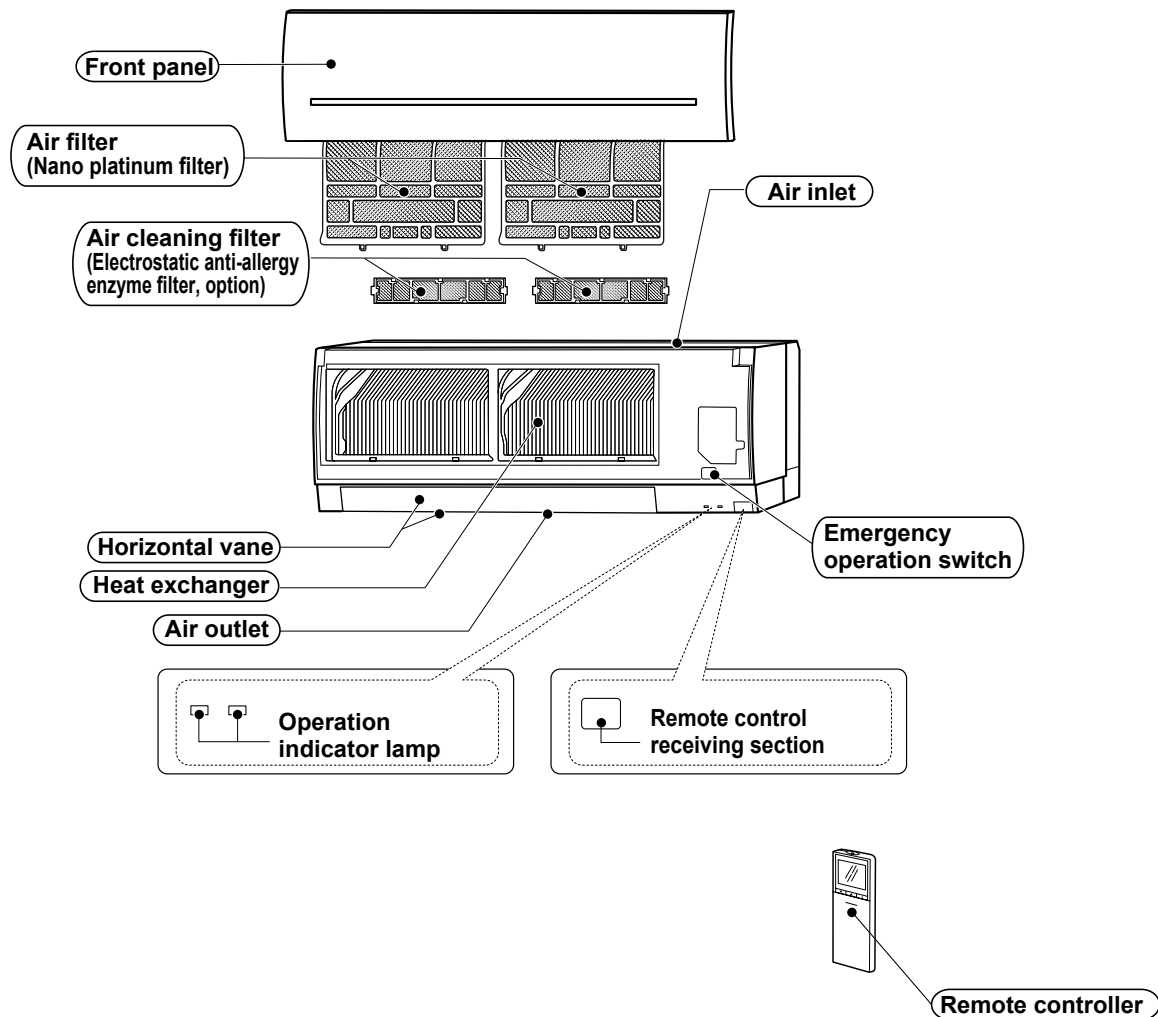

ACCESSORIES

Model	MSZ-SF25VE	MSZ-SF35VE	MSZ-SF42VE	MSZ-SF50VE
① Installation plate			1	
② Installation plate fixing screw 4 × 25 mm			5	
③ Remote controller holder			1	
④ Fixing screw for ③ 3.5 × 16 mm (Black)			2	
⑤ Battery (AAA) for remote controller			2	
⑥ Wireless remote controller			1	
⑦ Felt tape (For left or left-rear piping)			1	

3

SPECIFICATION

Indoor model			MSZ-SF25VE	MSZ-SF35VE	MSZ-SF42VE	MSZ-SF50VE		
Power supply			Single phase 230 V, 50 Hz					
Electrical data	Power input *1	Cooling	W	18		22		
		Heating		24	27	35		
	Running current *1	Cooling	A	0.16		0.18		
		Heating		0.20	0.22	0.27		
Fan motor	Model		RC0J21-AA					
	Current *1	Cooling	A	0.16		0.18		
		Heating		0.20	0.22	0.27		
Dimensions W × H × D			mm 798 × 299 × 195					
Weight			kg 10					
Air direction			5					
Special remarks	Airflow	Cooling	m³/h	Super High		546	594	
				High		432	474	492
				Med.		336	402	414
				Low		246	348	366
				Silent		210	300	336
		Heating	m³/h	Super High		618	660	720
				High		492	498	546
				Med.		402	432	480
				Low		246	348	384
				Silent		210	300	336
	Sound level	Cooling	dB(A)	Super High		42	45	
				High		36	38	40
				Med.		30	34	36
				Low		24	31	33
				Silent		21	28	30
		Heating	dB(A)	Super High		45	46	49
				High		39	42	43
				Med.		34	36	38
				Low		24	31	33
				Silent		21	28	30
Fan speed	Cooling	rpm	Super High		1,200	1,280		
			High		1,000	1,070	1,100	
			Med.		820	940	970	
			Low		660	850	880	
			Silent		590	760	820	
	Heating	rpm	Super High		1,330	1,400	1,500	
			High		1,100	1,120	1,200	
			Med.		940	1,000	1,080	
			Low		660	850	910	
			Silent		590	760	820	
Fan speed regulator			5					
Remote controller model			SG11D					

NOTE: Test conditions are based on ISO 5151.

Cooling: Indoor Dry-bulb temperature 27°C Wet-bulb temperature 19°C
 Outdoor Dry-bulb temperature 35°C
 Heating: Indoor Dry-bulb temperature 20°C Wet-bulb temperature 15°C
 Outdoor Dry-bulb temperature 7°C Wet-bulb temperature 6°C

*1 Measured under rated operating frequency.

Specifications and rated conditions of main electric parts

Fuse	(F11)	T3.15AL250V
Horizontal vane motor	(MV)	12 VDC
Varistor	(NR11)	S10K300E2K1 (ERZV10D471)
Terminal block	(TB)	3P

4

NOISE CRITERIA CURVES

MSZ-SF25VE

FAN SPEED	FUNCTION	SPL(dB(A))	LINE
Super High	COOLING	42	●—●
	HEATING	45	○—○

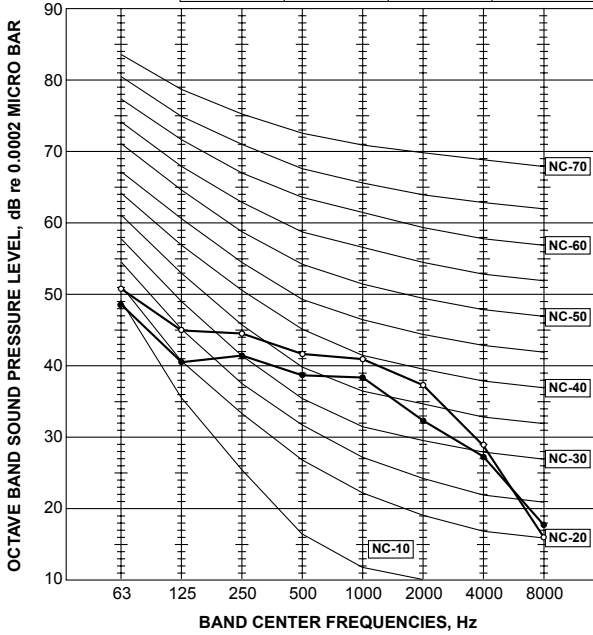

MSZ-SF35VE

FAN SPEED	FUNCTION	SPL(dB(A))	LINE
Super High	COOLING	42	●—●
	HEATING	46	○—○

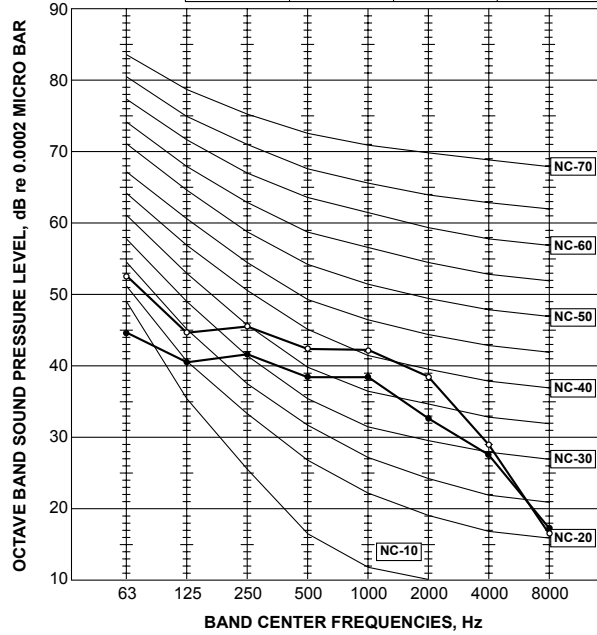

MSZ-SF42VE

FAN SPEED	FUNCTION	SPL(dB(A))	LINE
Super High	COOLING	42	●—●
	HEATING	47	○—○

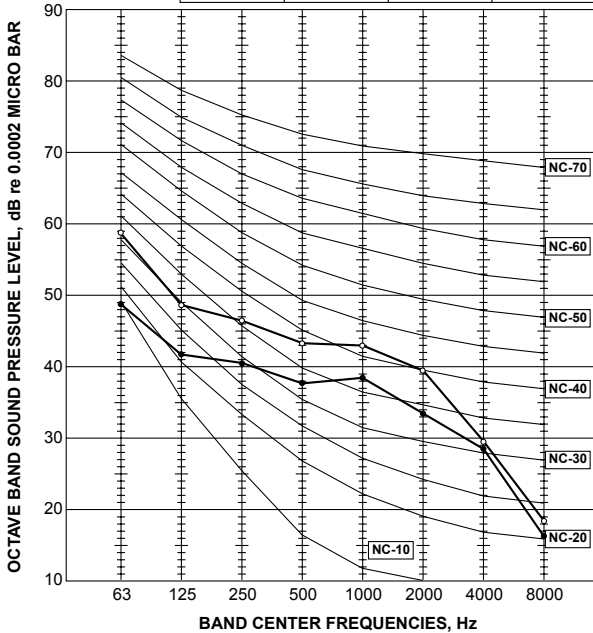

MSZ-SF50VE

FAN SPEED	FUNCTION	SPL(dB(A))	LINE
Super High	COOLING	45	●—●
	HEATING	49	○—○

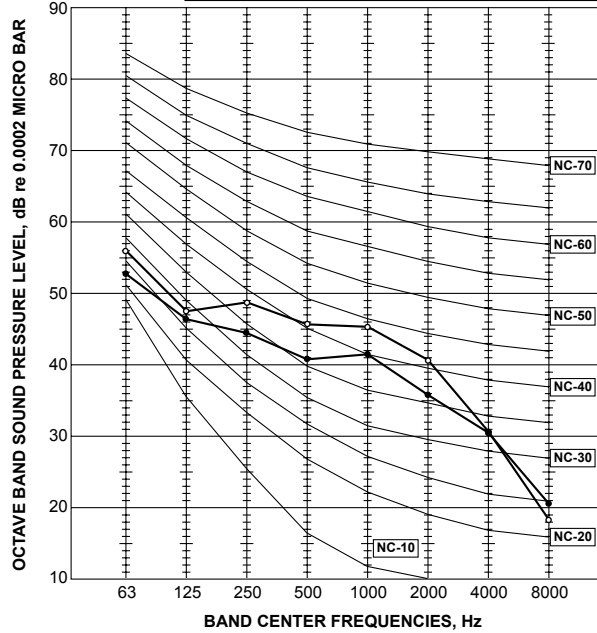

Test conditions

- Cooling: Dry-bulb temperature 27 °C
Wet-bulb temperature 19 °C
- Heating: Dry-bulb temperature 20 °C
Wet-bulb temperature 15 °C

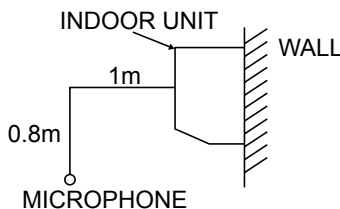

5

OUTLINES AND DIMENSIONS

MSZ-SF25VE MSZ-SF35VE MSZ-SF42VE MSZ-SF50VE

Unit: mm

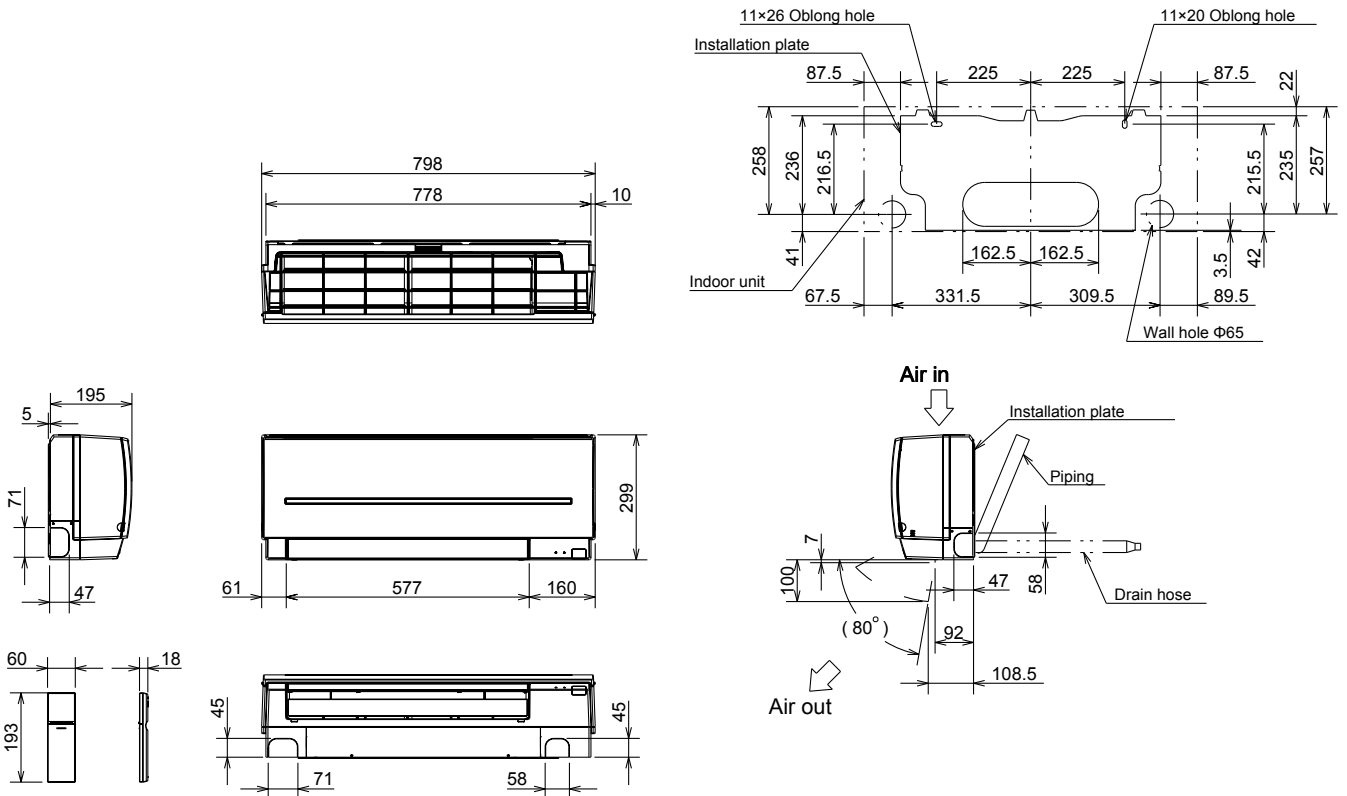

(MSZ-SF25/35/42/50VE- [E1], [E2], [ER2])

Piping	Insulation	Φ37 O.D
	Liquid line	Φ6.35 - 0.39m (Flared connection Φ6.35)
	Gas line	Φ9.52 - 0.34m [Flared connection Φ9.52 (MSZ-SF25/35/42VE), Φ12.7 (MSZ-SF50VE)]
Drain hose	Insulation Φ28 Connected part Φ16 O.D	

(MSZ-SF25/35/42/50VE- [EN1], [EN2])

Piping	Insulation	Φ37 O.D
	Liquid line	Φ6.35 - 0.5m (Flared connection Φ6.35)
	Gas line	Φ9.52 - 0.43m [Flared connection Φ9.52 (MSZ-SF25/35/42VE), Φ12.7 (MSZ-SF50VE)]
Drain hose	Insulation Φ28 Connected part Φ16 O.D	

6

WIRING DIAGRAM

MSZ-SF25VE- [E1, E2, EN1, EN2] MSZ-SF42VE- [E1, E2, EN1, EN2]

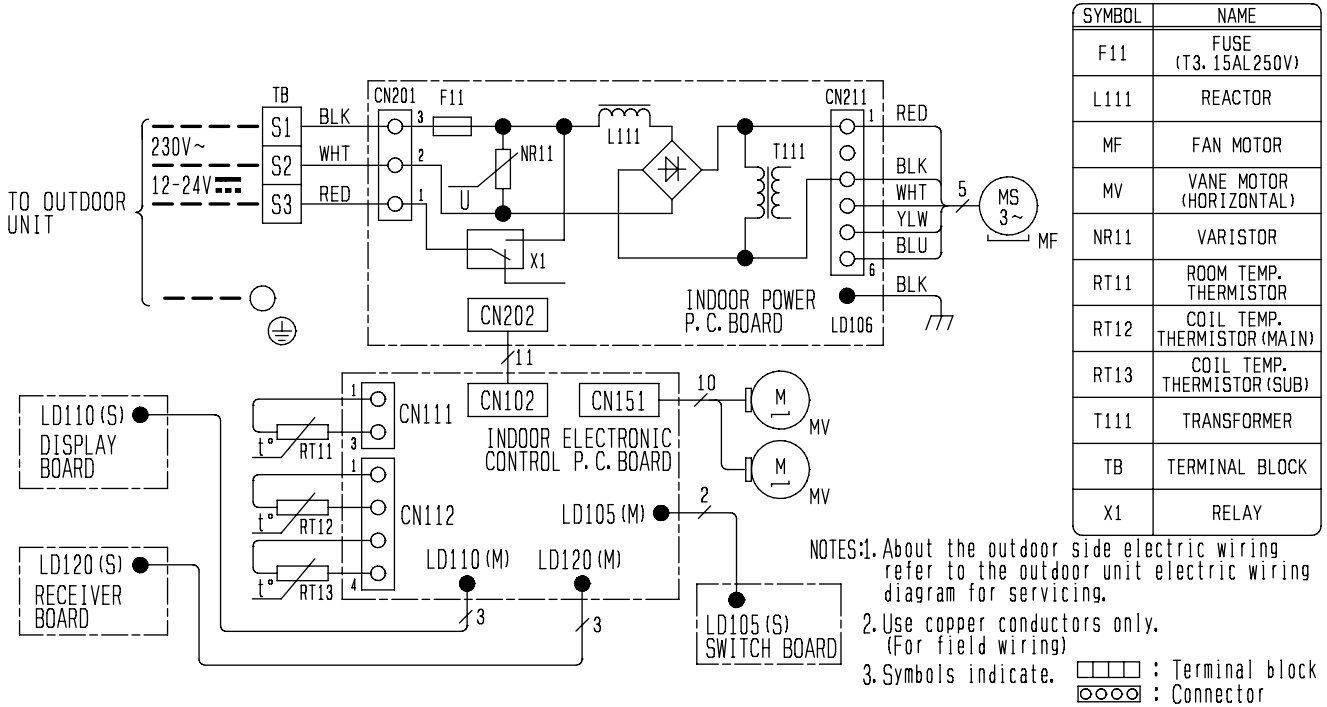

MSZ-SF25VE- [ER2] MSZ-SF42VE- [ER2]

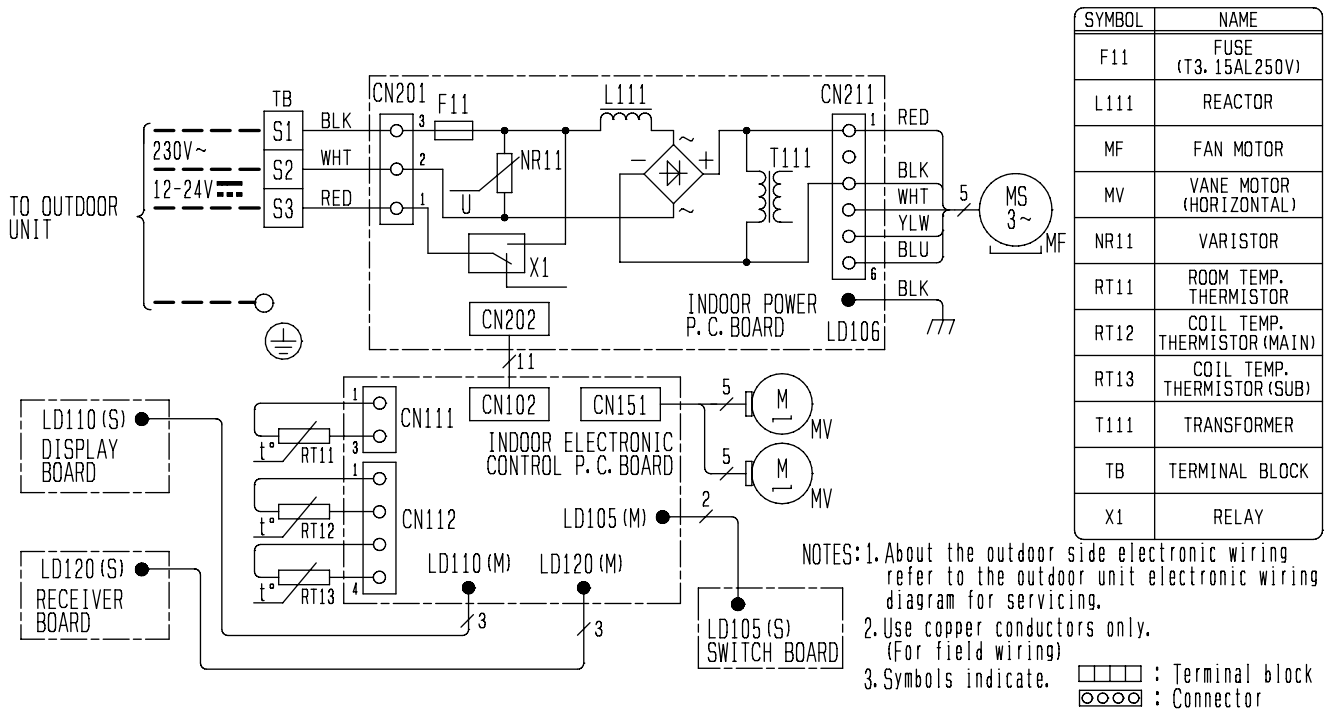

MSZ-SF35VE- E1, E2, EN1, EN2 **MSZ-SF50VE-** E1, E2, EN1, EN2

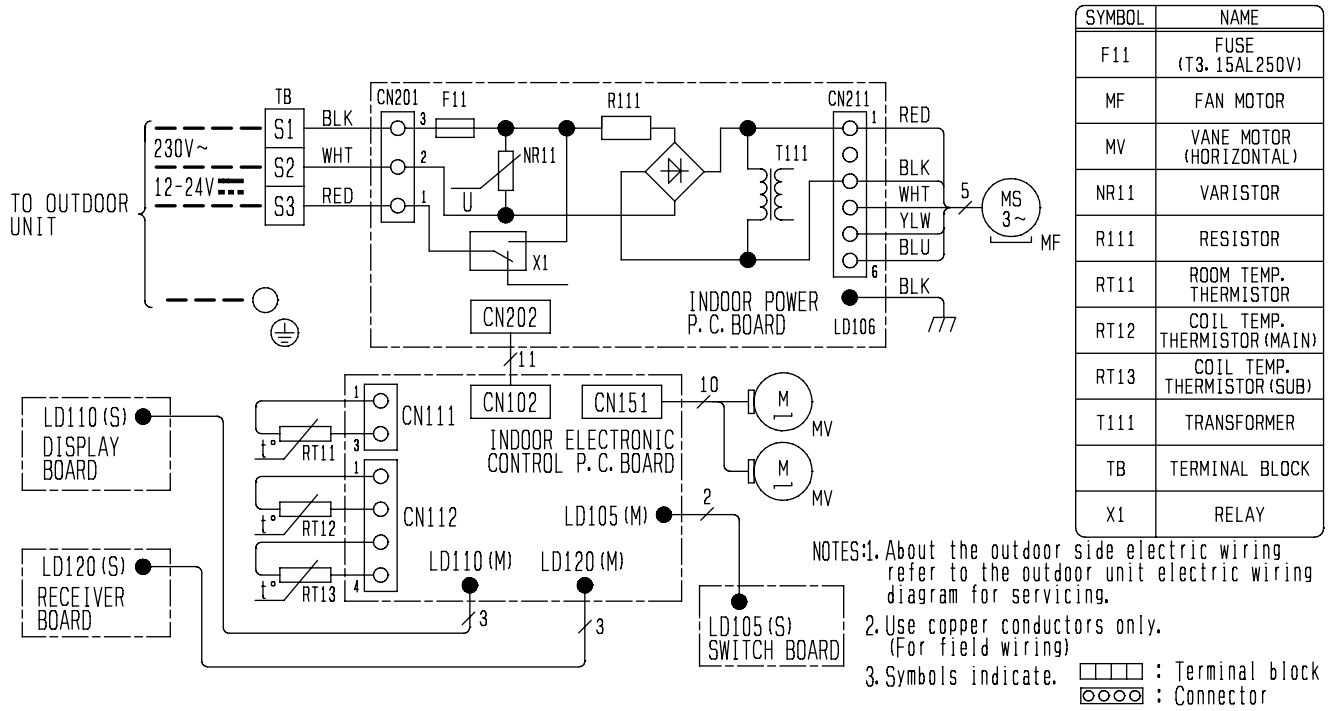

MSZ-SF35VE- ER2 **MSZ-SF50VE-** ER2

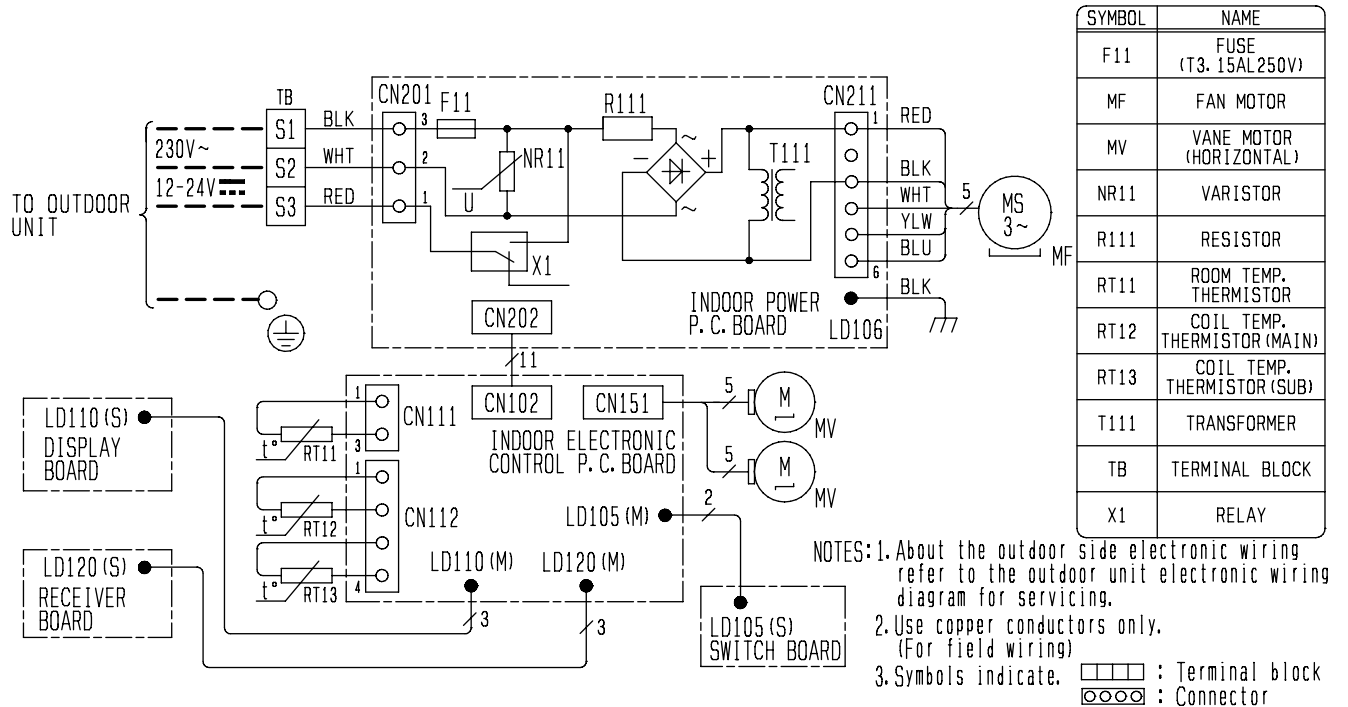

7

REFRIGERANT SYSTEM DIAGRAM

MSZ-SF25VE MSZ-SF35VE MSZ-SF42VE MSZ-SF50VE

Unit: mm

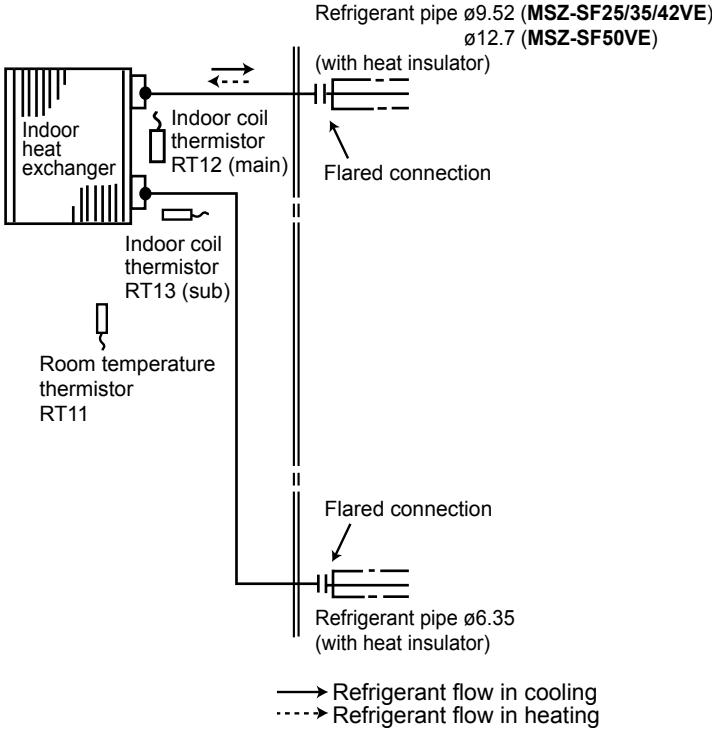

MSZ-SF25VE MSZ-SF35VE MSZ-SF42VE MSZ-SF50VE

8-1. TIMER SHORT MODE

For service, the following set time can be shortened by bridging JPG and JPS on the electronic control P.C. board.
(Refer to 10-7.)

Set time: 3 minutes → 3 seconds (It takes 3 minutes for the compressor to start operation. However, the starting time is shortened by bridging JPG and JPS.)

8-2. P.C. BOARD MODIFICATION FOR INDIVIDUAL OPERATION

A maximum of 4 indoor units with wireless remote controllers can be used in a room.

In this case, to operate each indoor unit individually by each remote controller, P.C. boards of remote controller must be modified according to the number of the indoor unit.

How to modify the remote controller P.C. board

Remove batteries before modification.

The board has a print as shown below:

NOTE: For modification, take out the batteries and press the OPERATE/STOP (ON/OFF) button 2 or 3 times at first.
After modification, put back the batteries then press the RESET button.

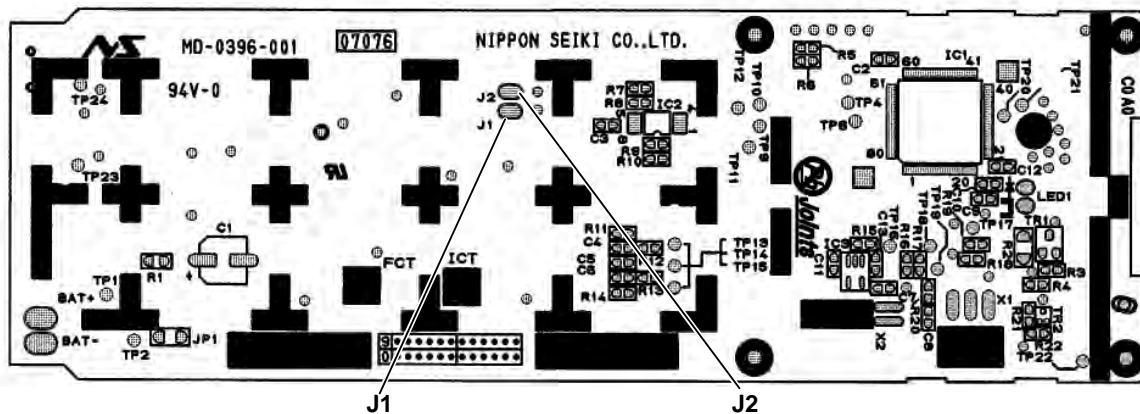

The P.C. board has the print "J1" and "J2". Solder "J1" and "J2" according to the number of indoor unit as shown in Table 1.
After modification, press the RESET button.

Table 1

	1 unit operation	2 units operation	3 units operation	4 units operation
No. 1 unit	No modification	Same as at left	Same as at left	Same as at left
No. 2 unit	—	Solder J1	Same as at left	Same as at left
No. 3 unit	—	—	Solder J2	Same as at left
No. 4 unit	—	—	—	Solder both J1 and J2

How to set the remote controller exclusively for particular indoor unit

After you turn the breaker ON, the first remote controller that sends the signal to the indoor unit will be regarded as the remote controller for the indoor unit.

The indoor unit will only accept the signal from the remote controller that has been assigned to the indoor unit once they are set.
The setting will be cancelled if the breaker is turned OFF, or the power supply is shut down.

Please conduct the above setting once again after the power has restored.

8-3. AUTO RESTART FUNCTION

When the indoor unit is controlled with the remote controller, the operation mode, the set temperature, and the fan speed are memorized by the indoor electronic control P.C. board. "AUTO RESTART FUNCTION" automatically starts operation in the same mode just before the shutoff of the main power.

Operation

- ① If the main power has been cut, the operation settings remain.
- ② After the power is restored, the unit restarts automatically according to the memory.
(However, it takes at least 3 minutes for the compressor to start running.)

How to disable "AUTO RESTART FUNCTION"

- ① Turn off the main power for the unit.
- ② Cut the jumper wire to JR77 on the indoor electronic control P.C. board. (Refer to 10-7.)

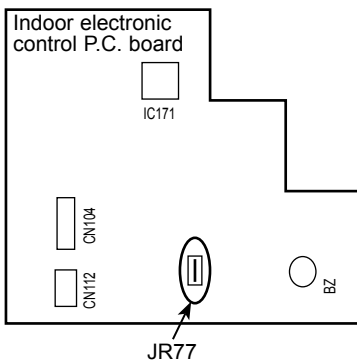

NOTE:

- The operation settings are memorized when 10 seconds have passed after the indoor unit was operated with the remote controller.
- If main power is turned OFF or a power failure occurs while AUTO START/STOP timer is active, the timer setting is cancelled.
- If the unit has been off with the remote controller before power failure, the auto restart function does not work as the power button of the remote controller is OFF.
- To prevent breaker OFF due to the rush of starting current, systematize other home appliance not to turn ON at the same time.
- When some air conditioners are connected to the same supply system, if they are operated before power failure, the starting current of all the compressors may flow simultaneously at restart. Therefore, the special counter-measures are required to prevent the main voltage-drop or the rush of the starting current by adding to the system that allows the units to start one by one.

MSZ-SF25VE MSZ-SF35VE MSZ-SF42VE MSZ-SF50VE

WIRELESS REMOTE CONTROLLER

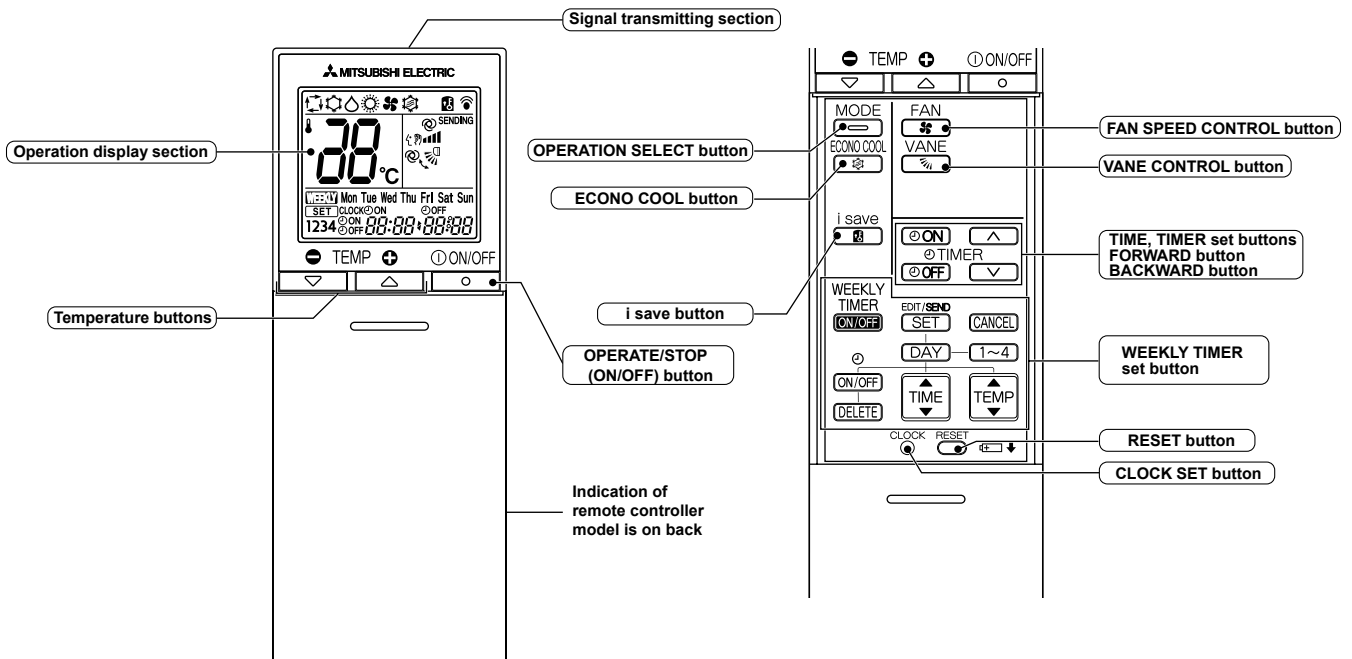

NOTE: Last setting will be stored after the unit is turned OFF with the remote controller. Indoor unit receives the signal of the remote controller with beeps.

INDOOR UNIT DISPLAY SECTION

Operation Indicator lamp

The operation indicator at the right side of the indoor unit indicates the operation state.

•The following indication applies regardless of shape of the indication.

Indication	Operation state	Room temperature
● ●	The unit is operating to reach the set temperature	About 2°C or more away from set temperature
● ○	The room temperature is approaching the set temperature	About 1 to 2°C from set temperature
● ☉	Standby mode (Only during multi system operation)	—

● Lighted
 ○ Blinking
 ○ Not lighted

9-1. COOL (❄️) OPERATION

- (1) Press OPERATE/STOP (ON/OFF) button.
OPERATION INDICATOR lamp of the indoor unit turns on with a beep tone.
- (2) Select COOL mode with OPERATION SELECT button.
- (3) Press TEMPERATURE buttons TEMP ⊖ or ⊕ button to select the desired temperature. The setting range is 16 - 31°C.

1. Coil frost prevention

The compressor operational frequency is controlled by the temperature of the indoor heat exchanger to prevent the coil from frosting.

When the temperature of indoor heat exchanger becomes too low, the coil frost prevention mode works.

The indoor fan operates at the set speed and the compressor stops. This mode continues until the temperature of indoor heat exchanger rises.

2. Low outside temperature operation

When the outside temperature is lower, low outside temperature operation starts, and the outdoor fan slows or stops.

3. Indoor fan speed control

When the thermostat turns OFF, the indoor fan operates very Low to reduce power consumption.

When the room temperature rises and the thermostat is ON, the indoor fan operates according to the settings on the remote controller.

9-2. DRY (△) OPERATION

- (1) Press OPERATE/STOP (ON/OFF) button.
OPERATION INDICATOR lamp of the indoor unit turns on with a beep tone.
- (2) Select DRY mode with OPERATION SELECT button.
- (3) The set temperature is determined from the initial room temperature.

1. Coil frost prevention

Coil frost prevention works the same way as that in COOL mode. (9-1.1.)

2. Low outside temperature operation

Low outside temperature operation works the same way as that in COOL mode. (9-1.2.)

3. Indoor fan speed control

Indoor fan speed control works the same way as that in COOL mode. (9-1.3.)

9-3. FAN (⚙) OPERATION

- (1) OPERATION INDICATOR lamp of the indoor unit turns on with a beep tone.
- (2) Select FAN mode with OPERATION SELECT button.
- (3) Select the desired fan speed. When AUTO, it becomes Low.
Only indoor fan operates.
Outdoor unit does not operate.

9-4. HEAT (☀) OPERATION

- (1) Press OPERATE/STOP (ON/OFF) button.
OPERATION INDICATOR lamp of the indoor unit turns on with a beep tone.
- (2) Select HEAT mode with OPERATION SELECT button.
- (3) Press TEMPERATURE buttons TEMP ⊖ or ⊕ button to select the desired temperature. The setting range is 16 - 31°C.

1. Cold air prevention control

When the compressor is not operating or is starting, and the temperature of indoor heat exchanger and/or the room temperature is low or when defrosting is being done, the indoor fan will stop or rotate in Very Low speed.

2. High pressure protection

The compressor operational frequency is controlled by the temperature of the indoor heat exchanger to prevent the condensing pressure from increasing excessively.

When the temperature of indoor heat exchanger becomes too high, the high pressure protection works.

The indoor fan operates following the cold air prevention control. This mode continues until the temperature of indoor heat exchanger falls.

3. Defrosting

Defrosting starts when the temperature of outdoor heat exchanger becomes too low.

The compressor stops once, the indoor/outdoor fans stop, the 4-way valve reverses, and the compressor re-starts.

This mode continues until the temperature of outdoor heat exchanger rises or the fixed time passes.

9-5. AUTO CHANGE OVER ... AUTO MODE OPERATION

Once desired temperature is set, unit operation is switched automatically between COOL and HEAT operation.

Mode selection

(1) Initial mode

When unit starts the operation with AUTO operation from OFF:

- If the room temperature is higher than the set temperature, operation starts in COOL mode.
- If the room temperature is equal to or lower than the set temperature, operation starts in HEAT mode.

(2) Mode change

COOL mode changes to HEAT mode when about 15 minutes have passed with the room temperature 1°C below the set temperature.

HEAT mode changes to COOL mode when about 15 minutes have passed with the room temperature 1°C above the set temperature.

NOTE 1

If two or more indoor units are operating in multi system, there might be a case that the indoor unit, which is operating in □ (AUTO), cannot change over to the other operating mode (COOL ↔ HEAT) and becomes a state of standby.

Refer to **NOTE 2 "FOR MULTI SYSTEM AIR CONDITIONER"**.

NOTE 2
FOR MULTI SYSTEM AIR CONDITIONER
OUTDOOR UNIT: MXZ series

Multi system air conditioner can connect two or more indoor units with one outdoor unit.

- When you try to operate two or more indoor units with one outdoor unit simultaneously, one for the cooling and the others for heating, the operation mode of the indoor unit that operates first is selected. Other indoor units cannot operate, and operation indicator lamp flashes as shown in the figure below. In this case, please set all the indoor units to the same operation mode.

OPERATION INDICATOR

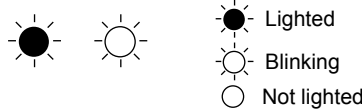

- When indoor unit starts the operation while the defrosting of outdoor unit is being done, it takes a few minutes (max. 10 minutes) to blow out the warm air.
- In the heating operation, though indoor unit that does not operate may get warm or the sound of refrigerant flowing may be heard, they are not malfunction. The reason is that the refrigerant continuously flows into it.

9-6. AUTO VANE OPERATION

1. Horizontal vane

(1) Vane motor drive

These models are equipped with a stepping motor for the horizontal vane. The rotating direction, speed, and angle of the motor are controlled by pulse signals (approximately 12 V) transmitted from indoor microprocessor.

(2) The horizontal vane angle and mode change as follows by pressing VANE CONTROL button.

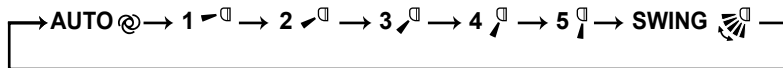

(3) Positioning

To confirm the standard position, the vane moves until it touches the vane stopper. Then the vane is set to the selected angle.

Confirming of standard position is performed in the following cases:

- (a) When the operation starts or finishes (including timer operation).
- (b) When the test run starts.
- (c) When standby mode (only during multi system operation) starts or finishes.

(4) VANE AUTO (@) mode

In VANE AUTO mode, the microprocessor automatically determines the vane angle to make the optimum room temperature distribution.

In COOL and DRY operation

Vane angle is fixed to Horizontal position.



In HEAT operation

Vane angle is fixed to Angle 4.



(5) STOP (operation OFF) and ON TIMER standby

In the following cases, the horizontal vane returns to the closed position.

- (a) When OPERATE/STOP (ON/OFF) button is pressed (POWER OFF).
- (b) When the operation is stopped by the emergency operation.
- (c) When ON TIMER is ON standby.

(6) Dew prevention

During COOL or DRY operation with the vane angle at Angle 4 or 5 when the compressor cumulative operation time exceeds 1 hour, the vane angle automatically changes to Angle 1 for dew prevention.

(7) SWING mode

By selecting SWING mode with VANE CONTROL button, the horizontal vanes swing vertically.

When COOL, DRY or FAN mode is selected, only the upper vane swings.

(8) Cold air prevention in HEAT operation

The horizontal vane position is set to Upward.

NOTE: When 2 or more indoor units are operated with multi outdoor unit, even if any indoor unit turns thermostat off, this control does not work in the indoor unit.

(9) ECONO COOL (🌀) operation (ECONomical operation)

When ECONO COOL button is pressed in COOL mode, set temperature is automatically set 2°C higher by the microprocessor. (However, the temperature on the LCD screen on the remote controller is not changed.)

Also the horizontal vane swings in various cycle.

SWING operation makes you feel cooler than set temperature. So, even though the set temperature is higher, the air conditioner can keep comfort. As a result, energy can be saved.

To cancel this operation, select a different mode or press one of the following buttons in ECONO COOL operation: ECONO COOL, or VANE CONTROL button.

9-7. TIMER OPERATION

1. How to set the time

(1) Check that the current time is set correctly.

NOTE: Timer operation will not work without setting the current time. Initially “0:00” blinks at the current time display of TIME MONITOR, so set the current time correctly with CLOCK SET button.

How to set the current time

(a) Press the CLOCK set button.

(b) Press the TIME SET buttons (⏮ and ⏭) to set the current time.

- Each time FORWARD button (⏮) is pressed, the set time increases by 1 minute, and each time BACKWARD button (⏭) is pressed, the set time decreases by 1 minute.
- Pressing those buttons longer, the set time increases/decreases by 10 minutes.

(c) Press the CLOCK set button.

(2) Press OPERATE/STOP (ON/OFF) button to start the air conditioner.

(3) Set the time of timer.

ON timer setting

(a) Press ON TIMER button (🕒ON) during operation.

(b) Set the time of the timer using TIME SET buttons (⏮ and ⏭).*

OFF timer setting

(a) Press OFF TIMER button (🕒OFF) during operation.

(b) Set the time of the timer using TIME SET buttons (⏮ and ⏭).*

* Each time FORWARD button (⏮) is pressed, the set time increases by 10 minutes: each time BACKWARD button (⏭) is pressed, the set time decreases by 10 minutes.

2. To release the timer

To release ON timer, press ON TIMER button (🕒ON).

To release OFF timer, press OFF TIMER button (🕒OFF).

TIMER is cancelled and the display of set time disappears.

PROGRAM TIMER

- OFF timer and ON timer can be used in combination. The timer of the set time that is reached first will operate first.
- “◀” and “▶” display shows the order of OFF timer and ON timer operation.

(Example 1) The current time is 8:00 PM.

The unit turns off at 11:00 PM, and on at 6:00 AM.

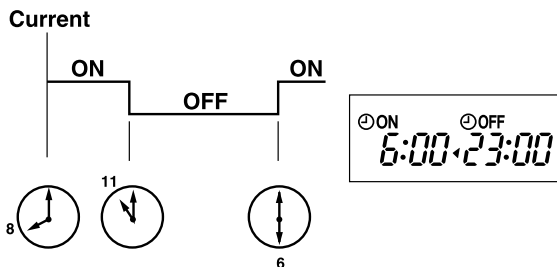

(Example 2) The current time is 11:00 AM.

The unit turns on at 5:00 PM, and off at 9:00 PM.

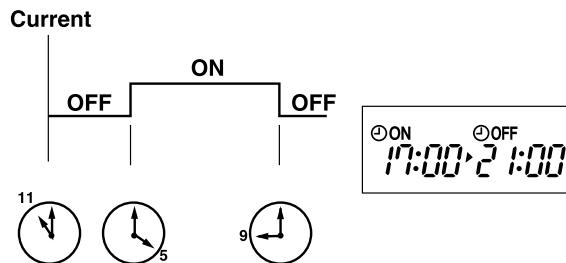

NOTE: If the main power is turned OFF or a power failure occurs while ON/OFF timer is active, the timer setting is cancelled. As these models are equipped with an auto restart function, the air conditioner starts operating with timer cancelled when power is restored.

9-8. WEEKLY TIMER OPERATION

- A maximum of 4 ON or OFF timers can be set for individual days of the week.
- A maximum of 28 ON or OFF timers can be set for a week.

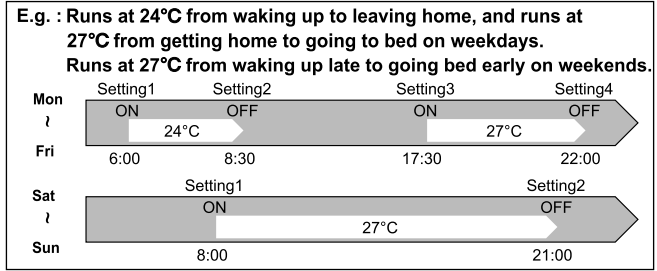

NOTE:

- The simple ON/OFF timer setting is available while the weekly timer is on. In this case, the ON/OFF timer has priority over the weekly timer; the weekly timer operation will start again after the simple ON/OFF timer is complete.
- When the weekly timer is set, temperature cannot be set to 10°C.
- The weekly timer operation and i-save operation cannot be used together.

1. How to set the weekly timer

* Make sure that the current time and day are set correctly.

- (1) Press **EDIT/SEND SET** button to enter the weekly timer setting mode.

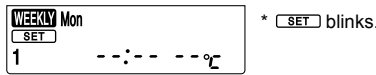

- (2) Press **DAY** and **1~4** buttons to select setting day and number.

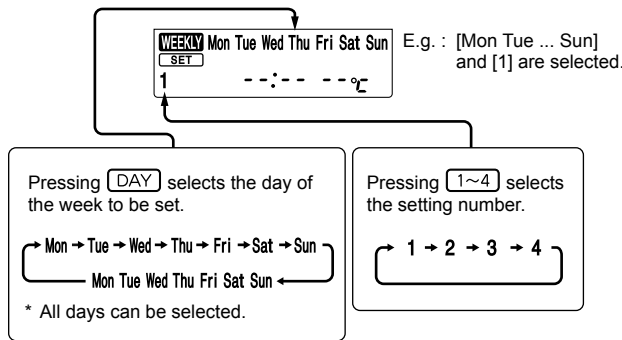

- (3) Press **ON/OFF**, **TIME**, and **TEMP** buttons to set ON/OFF, time, and temperature.

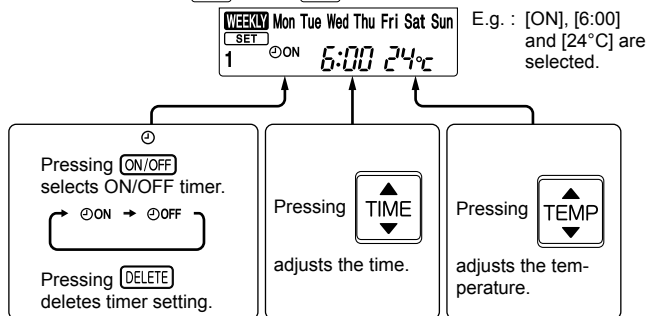

* Hold down the button to change the time quickly.

Press **DAY** and **1~4** buttons to continue setting the timer for other days and/or numbers.

- (4) Press **EDIT/SEND SET** button to complete and transmit the weekly timer setting.



NOTE:

- Press **EDIT/SEND SET** button to transmit the setting information of weekly timer to the indoor unit. Point the remote controller toward the indoor unit for 3 seconds.
- When setting the timer for more than one day of the week or one number, **EDIT/SEND SET** button does not have to be pressed per each setting. Press **EDIT/SEND SET** button once after all the settings are complete. All the weekly timer settings will be saved.
- Press **EDIT/SEND SET** button to enter the weekly timer setting mode, and press and hold **DELETE** button for 5 seconds to erase all weekly timer settings. Point the remote controller toward the indoor unit.

(5) Press  button to turn the weekly timer ON. (**WEEKLY** lights.)

•When the weekly timer is ON, the day of the week whose timer setting is complete, will light.

Press  button again to turn the weekly timer OFF. (**WEEKLY** goes out.)



NOTE:

The saved settings will not be cleared when the weekly timer is turned OFF.

2. Checking weekly timer setting

(1) Press  button to enter the weekly timer setting mode.

* blinks.

(2) Press  or  buttons to view the setting of the particular day or number.

(3) Press  button to exit the weekly timer setting.

9-9. i-save (i) OPERATION

1. How to set i-save operation

- (1) Press OPERATE/STOP (ON/OFF) button.
- (2) Select COOL, HEAT or ECONO COOL mode.
- (3) Press i-save button.
- (4) Set the temperature, fan speed, and airflow direction for i-save operation.

NOTE:

- i-save operation cannot be selected during DRY or AUTO mode operation.
- The setting range of HEAT mode i-save operation is 10°C and 16 - 31°C.
- 2 groups of setting can be saved. (One for COOL/ECONO COOL, one for HEAT)
- i-save operation and the weekly timer operation cannot be used together.

2. How to cancel operation

- Press i-save button again.
 - i-save operation can also be cancelled by pressing OPERATION SELECT button to change the operation mode.
- The same setting is select from the next time by simply pressing i-save button.

9-10. EMERGENCY/TEST OPERATION

In case of test run operation or emergency operation, use EMERGENCY OPERATION switch on the right side of the indoor unit. Emergency operation is available when the remote controller is missing, has failed or the batteries of the remote controller run down. The unit will start and OPERATION INDICATOR lamp will light.

The first 30 minutes of operation is the test run operation. This operation is for servicing. The indoor fan runs at High speed and the temperature control does not work.

After 30 minutes of test run operation, the system shifts to EMERGENCY COOL/HEAT MODE with a set temperature of 24°C. The fan speed shifts to Med.

The coil frost prevention works even in the test run or the emergency operation.

In the test run or emergency operation, the horizontal vane operates in VANE AUTO (@) mode.

Emergency operation continues until EMERGENCY OPERATION switch is pressed once or twice or the unit receives any signal from the remote controller. In case of latter, normal operation will start.

NOTE: Do not press EMERGENCY OPERATION switch during normal operation.

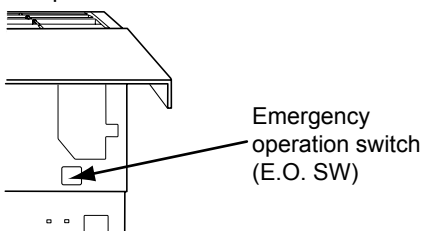

Operation mode	COOL/HEAT
Set temperature	24°C
Fan speed	Med.
Horizontal vane	Auto

The operation mode is indicated by the Operation Indicator lamp as following

Operation Indicator lamp

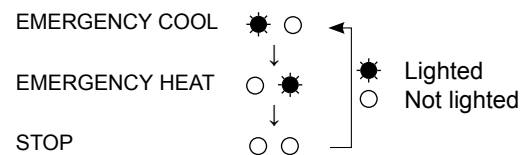

9-11. 3-MINUTE TIME DELAY OPERATION

When the system turns OFF, compressor will not restart for 3 minutes as 3-minute time delay function operates to protect compressor from overload.

MSZ-SF25VE MSZ-SF35VE MSZ-SF42VE MSZ-SF50VE

10-1. CAUTIONS ON TROUBLESHOOTING

1. Before troubleshooting, check the following

- 1) Check the power supply voltage.
- 2) Check the indoor/outdoor connecting wire for miswiring.

2. Take care of the following during servicing

- 1) Before servicing the air conditioner, be sure to turn OFF the main unit first with the remote controller, and after confirming the horizontal vane is closed, turn OFF the breaker and/or disconnect the power plug.
- 2) Be sure to turn OFF the power supply before removing the front panel, the cabinet, the top panel, and the P.C. board.
- 3) When removing the P.C. board, hold the edge of the board with care NOT to apply stress on the components.
- 4) When connecting or disconnecting the connectors, hold the housing of the connector. DO NOT pull the lead wires.

<Incorrect>



Lead wiring

<Correct>

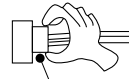

Housing point

3. Troubleshooting procedure

- 1) Check if the OPERATION INDICATOR lamp on the indoor unit is flashing ON and OFF to indicate an abnormality. To make sure, check how many times the OPERATION INDICATOR lamp is flashing ON and OFF before starting service work.
- 2) Before servicing, check that the connector and terminal are connected properly.
- 3) When the electronic control P.C. board seems to be defective, check the copper foil pattern for disconnection and the components for bursting and discoloration.
- 4) When troubleshooting, refer to 10-2, 10-3 and 10-4.

4. How to replace batteries

Weak batteries may cause the remote controller malfunction.

In this case, replace the batteries to operate the remote controller normally.

- ① Remove the front lid and insert batteries.

Then reattach the front lid.

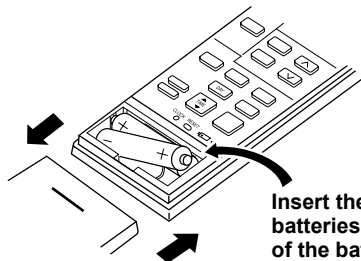

Insert the negative pole of the batteries first. Check if the polarity of the batteries is correct.

- ② Press RESET button with a thin instrument, and then use the remote controller.

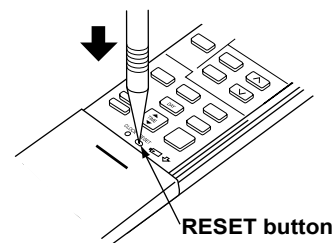

RESET button

NOTE: 1. If RESET button is not pressed, the remote controller may not operate correctly.

2. This remote controller has a circuit to automatically reset the microcomputer when batteries are replaced.

This function is equipped to prevent the microcomputer from malfunctioning due to the voltage drop caused by the battery replacement.

3. Do not use the leaking batteries.

10-2. FAILURE MODE RECALL FUNCTION

Outline of the function

This air conditioner can memorize the abnormal condition which has occurred once.

Even though LED indication listed on the troubleshooting check table (10-4.) disappears, the memorized failure details can be recalled.

1. Flow chart of failure mode recall function for the indoor/outdoor unit

Operational procedure

The cause of abnormality cannot be found because the abnormality does not recur.

Setting up the failure mode recall function

Turn ON the power supply.
 <Preparation of the remote controller>
 ① While pressing both OPERATION SELECT button and TEMP \oplus button on the remote controller at the same time, press RESET button.
 ② First, release RESET button.
 Hold down the other two buttons for another 3 seconds. Make sure that the indicators on the LCD screen shown in the right figure are all displayed. Then release the buttons.

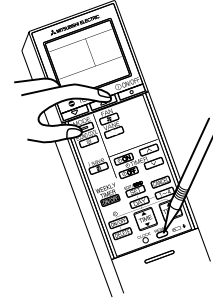

Press OPERATE/STOP (ON/OFF) button of the remote controller (the set temperature is displayed) with the remote controller headed towards the indoor unit. ※1

※1 Regardless of normal or abnormal condition, a short beep is emitted once the signal is received.

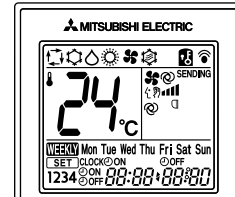

Does the left lamp of OPERATION INDICATOR lamp on the indoor unit blink at the interval of 0.5 seconds?
 Blinks: Either indoor or outdoor unit is abnormal.
 Beep is emitted at the same timing as the blinking of the left lamp of OPERATION INDICATOR lamp. ※2

Indoor unit is normal.
 But the outdoor unit might be abnormal because there are some abnormalities that can not be recalled with this way.
 Confirm if outdoor unit is abnormal according to the detailed outdoor unit failure mode recall function.

NOTE: It takes up to 1 minute to indicate the outdoor unit abnormality. Even if the OPERATION INDICATOR lamp is not lighting, keep checking at least 1 minute or longer.

Judgment of indoor/outdoor abnormality

Before blinking, does the left lamp of OPERATION INDICATOR lamp stay ON for 3 seconds?
 Stays ON for 3 seconds (without beep):
 The outdoor unit is abnormal.

The indoor unit is abnormal.
 Check the blinking pattern, and identify the abnormal point by referring to the indoor unit failure mode table. (Refer to 10-2.2)
 Make sure to check at least two consecutive blinking cycles. ※2

The outdoor unit is abnormal.
 Check the blinking pattern, and identify the abnormal point by referring to the outdoor unit failure mode table. (Refer to outdoor unit service manual.)
 Make sure to check at least two consecutive blinking cycles. ※3

Releasing the failure mode recall function

Release the failure mode recall function by the following procedures.
 Turn OFF the power supply and turn it ON again.
 Press RESET button of the remote controller.

Repair the failure parts.

Deleting the memorized abnormal condition

- ① After repairing the unit, recall the failure mode again according to "Setting up the failure mode recall function" mentioned above.
- ② Press OPERATE/STOP (ON/OFF) button of the remote controller (the set temperature is displayed) with the remote controller headed towards the indoor unit.
- ③ Press EMERGENCY OPERATION switch so that the memorized abnormal condition is deleted. ※4
- ④ Release the failure mode recall function according to "Releasing the failure mode recall function" mentioned above.

NOTE: 1. Make sure to release the failure mode recall function after it is set up, otherwise the unit cannot operate properly.
 2. If the abnormal condition is not deleted from the memory, the last abnormal condition is kept memorized.

※2. Blinking pattern when the indoor unit is abnormal:

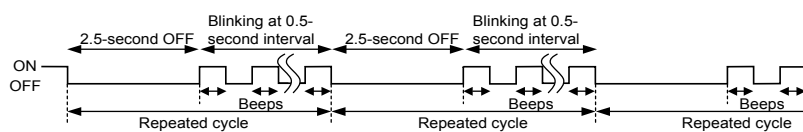

※3. Blinking pattern when the outdoor unit is abnormal:

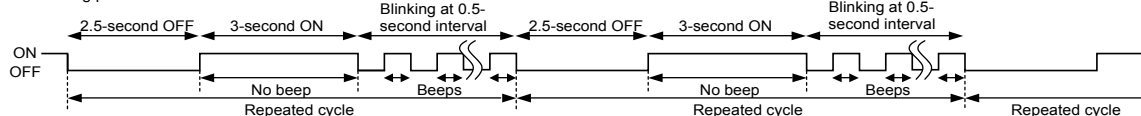

※4 The information regarding whether the connected outdoor unit is a low-standby-power model or a non-low-standby-power model will also be initialized. (Default= compatible with a low-standby-power model)



2. Indoor unit failure mode table

The left lamp of OPERATION INDICATOR lamp	Abnormal point (Failure mode)	Condition	Remedy
Not lighted	Normal	—	—
1-time flash every 0.5-second	Room temperature thermistor	The room temperature thermistor short or open circuit is detected every 8 seconds during operation.	Refer to the characteristics of the room temperature thermistor (10-7.).
2-time flash 2.5-second OFF	Indoor coil thermistor	The indoor coil thermistor short or open circuit is detected every 8 seconds during operation.	Refer to the characteristics of the main indoor coil thermistor, the sub indoor coil thermistor (10-7.).
3-time flash 2.5-second OFF	Serial signal	The serial signal from outdoor unit is not received for a maximum of 6 minutes.	Refer to 10-6.⑥ "How to check miswiring and serial signal error".
11-time flash 2.5-second OFF	Indoor fan motor	The rotational frequency feedback signal is not emitted for the 12 seconds after the indoor fan motor is operated.	Refer to 10-6.④ "Check of indoor fan motor".
12-time flash 2.5-second OFF	Indoor control system	It cannot properly read data in the nonvolatile memory of the indoor electronic control P.C. board.	Replace the indoor electronic control P.C. board.

NOTE: Blinking patterns of this mode differ from the ones of TROUBLESHOOTING CHECK TABLE (10-4.).

10-3. INSTRUCTION OF TROUBLESHOOTING

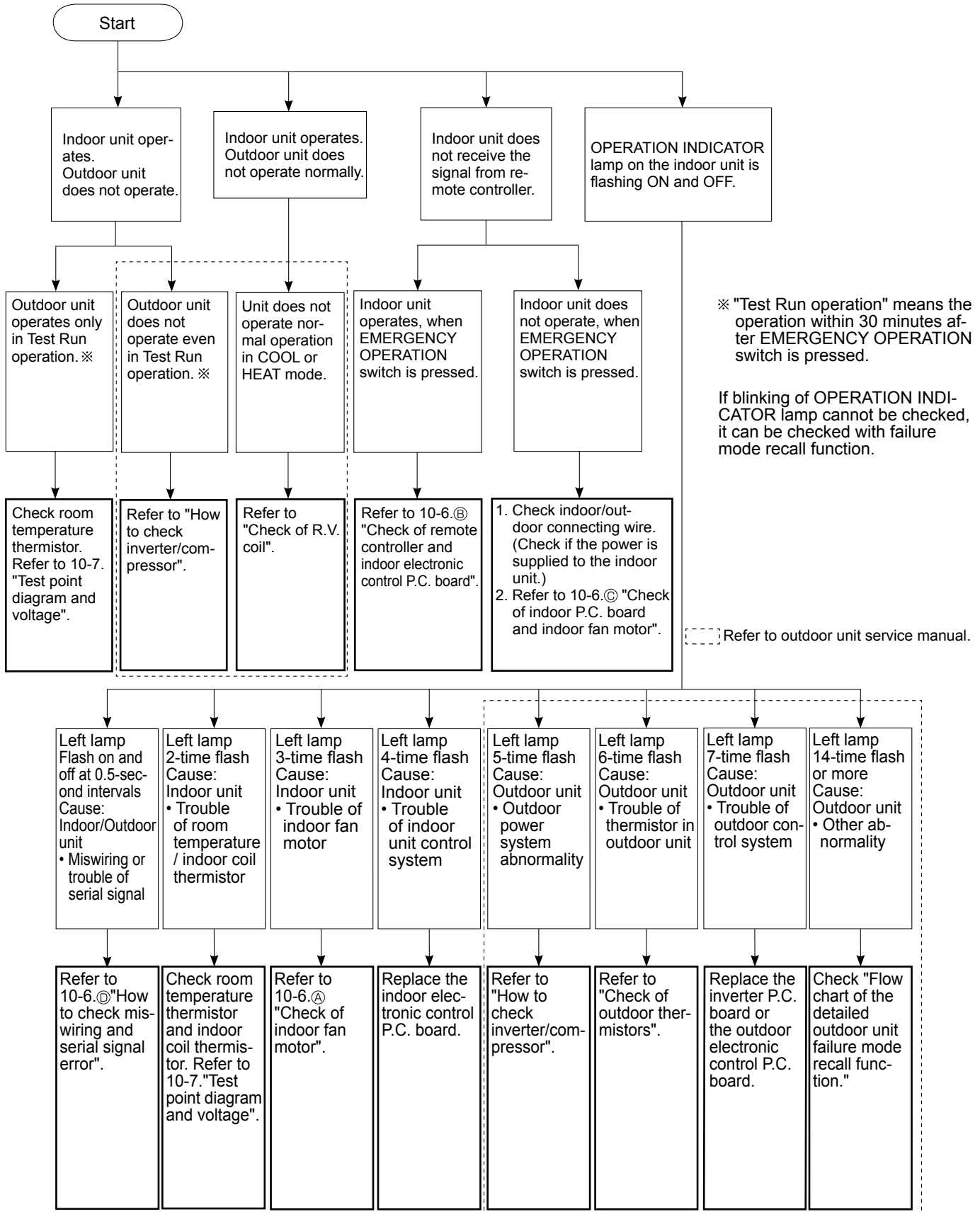

OPERATION INDICATOR

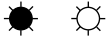

No.	Abnormal point	Operation indicator lamp	Symptom	Condition	Remedy
1	MXZ type Operation mode setting	Left lamp lights and lower lamp flashes. 2.5-second OFF	Outdoor unit operates but indoor unit does not operate.	The operation mode of the each indoor unit is differently set to COOL (includes DRY) and HEAT at the same time, the operation mode of the indoor unit that has operated at first has the priority.	<ul style="list-style-type: none"> Unify the operation mode. Refer to outdoor unit service manual.

10-5. TROUBLE CRITERION OF MAIN PARTS

MSZ-SF25VE MSZ-SF35VE MSZ-SF42VE MSZ-SF50VE

Part name	Check method and criterion	Figure			
Room temperature thermistor (RT11) Indoor coil thermistor (RT12, RT13)	Measure the resistance with a tester. Refer to 10-7. "Test point diagram and voltage", "Indoor electronic control P.C. board", for the chart of thermistor.				
Indoor fan motor (MF)	Check 10-6.Ⓐ "Check of indoor fan motor".				
Vane motor (MV)	Measure the resistance between the terminals with a tester. (Temperature: 10 - 30°C) <table border="1" style="margin-left: 20px;"> <thead> <tr> <th>Color of the lead wire</th> <th>Normal</th> </tr> </thead> <tbody> <tr> <td>RED - BLK</td> <td>232 - 268 Ω</td> </tr> </tbody> </table>		Color of the lead wire	Normal	RED - BLK
Color of the lead wire	Normal				
RED - BLK	232 - 268 Ω				

10-6. TROUBLESHOOTING FLOW

A Check of indoor fan motor

The indoor fan motor error has occurred, and the indoor fan does not operate.

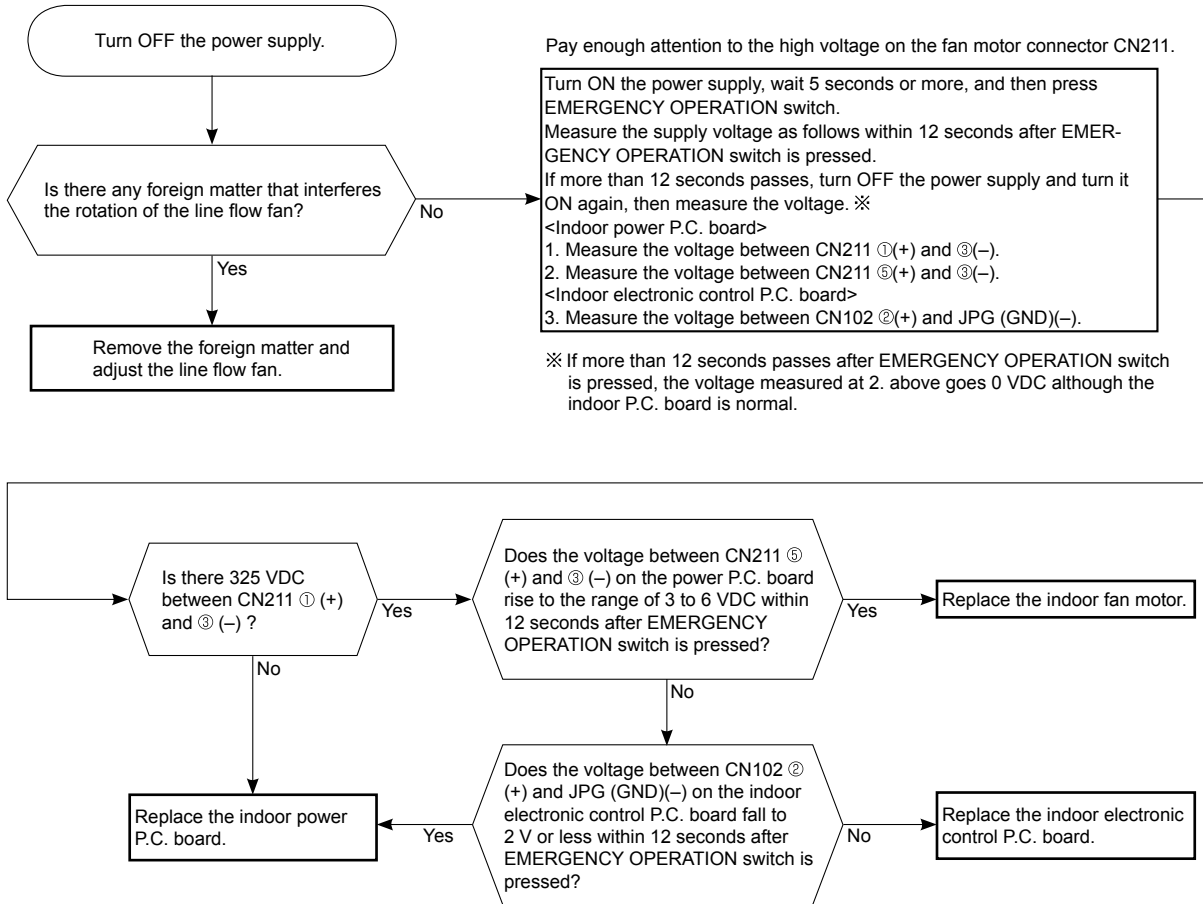

The indoor fan motor error has occurred, and the indoor fan repeats "12-second ON and 30-second OFF" 3 times, and then stops.

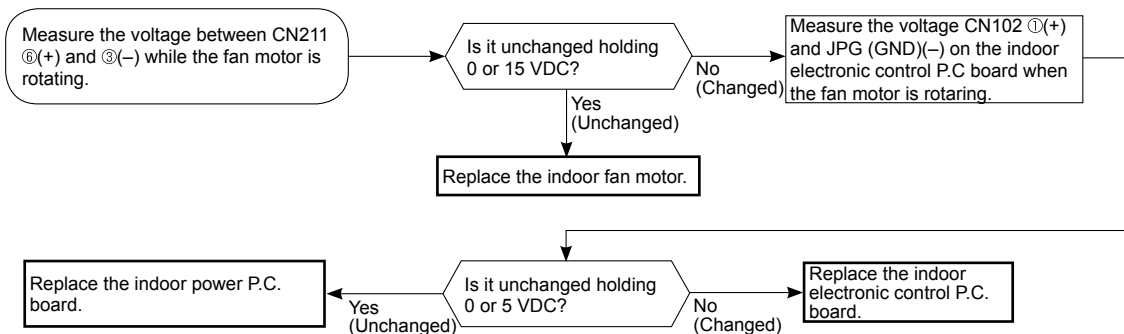

B Check of remote controller and indoor electronic control P.C. board

※Check if the remote controller is exclusive for this air conditioner.

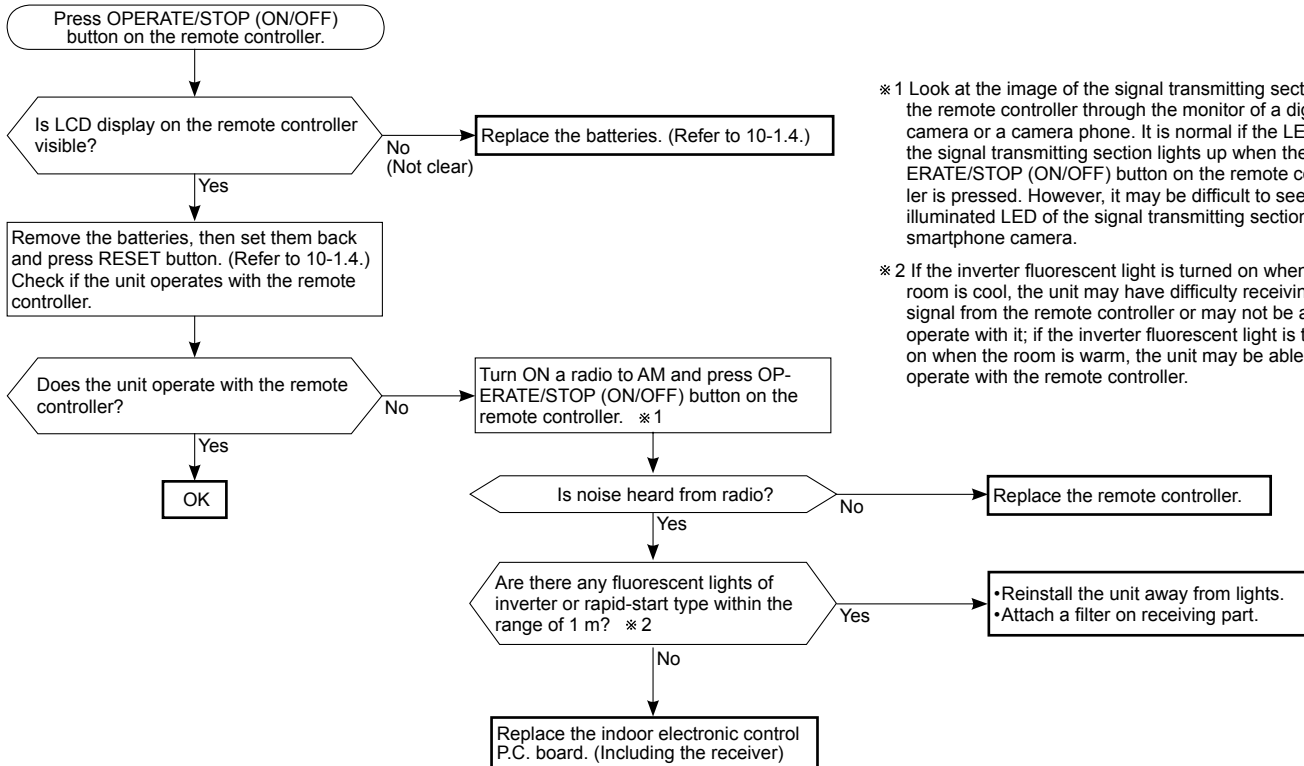

※ 1 Look at the image of the signal transmitting section of the remote controller through the monitor of a digital camera or a camera phone. It is normal if the LED of the signal transmitting section lights up when the OPERATE/STOP (ON/OFF) button on the remote controller is pressed. However, it may be difficult to see the illuminated LED of the signal transmitting section with a smartphone camera.

※ 2 If the inverter fluorescent light is turned on when the room is cool, the unit may have difficulty receiving the signal from the remote controller or may not be able to operate with it; if the inverter fluorescent light is turned on when the room is warm, the unit may be able to operate with the remote controller.

© Check of indoor P.C. board and indoor fan motor

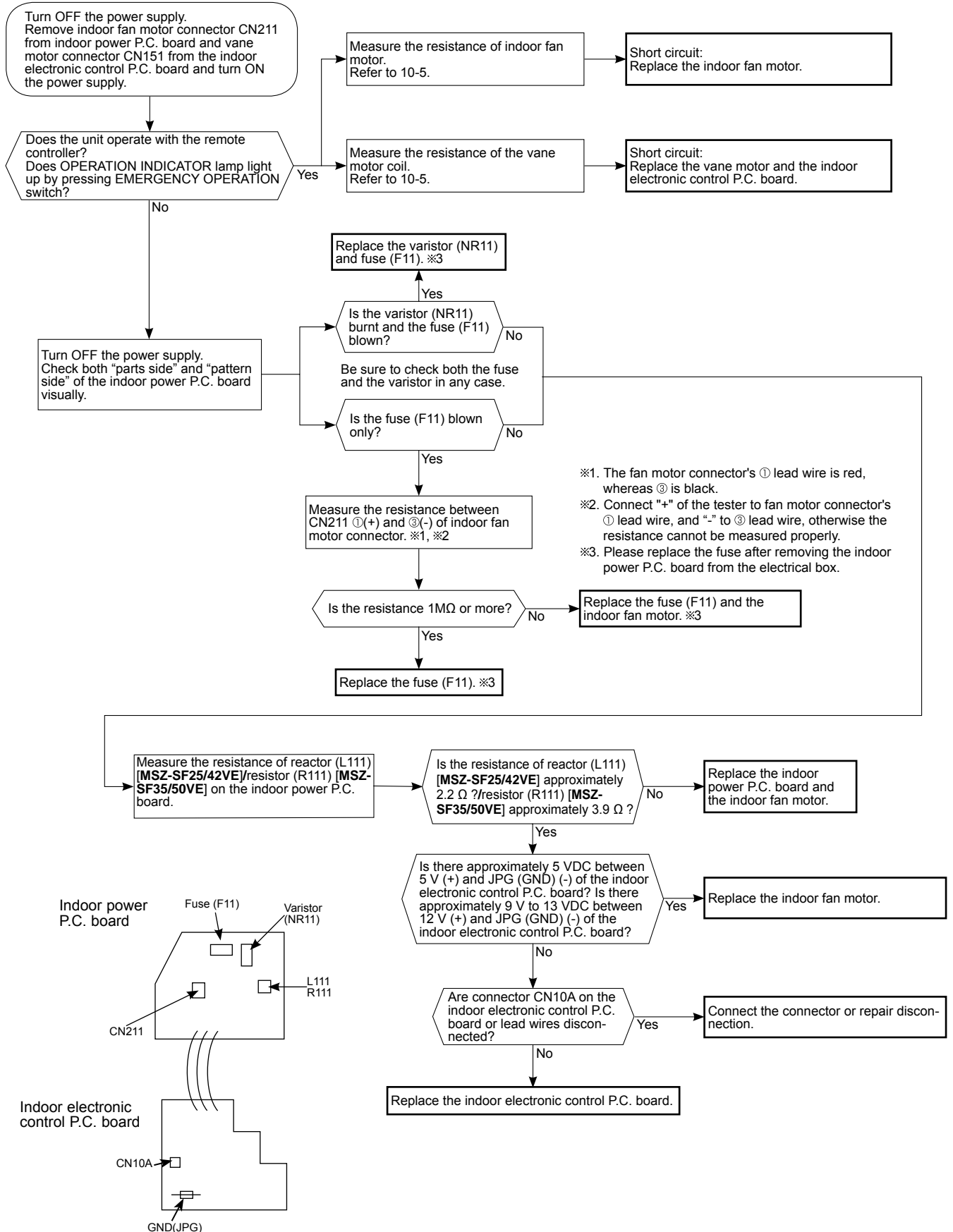

D How to check miswiring and serial signal error

MUZ Type

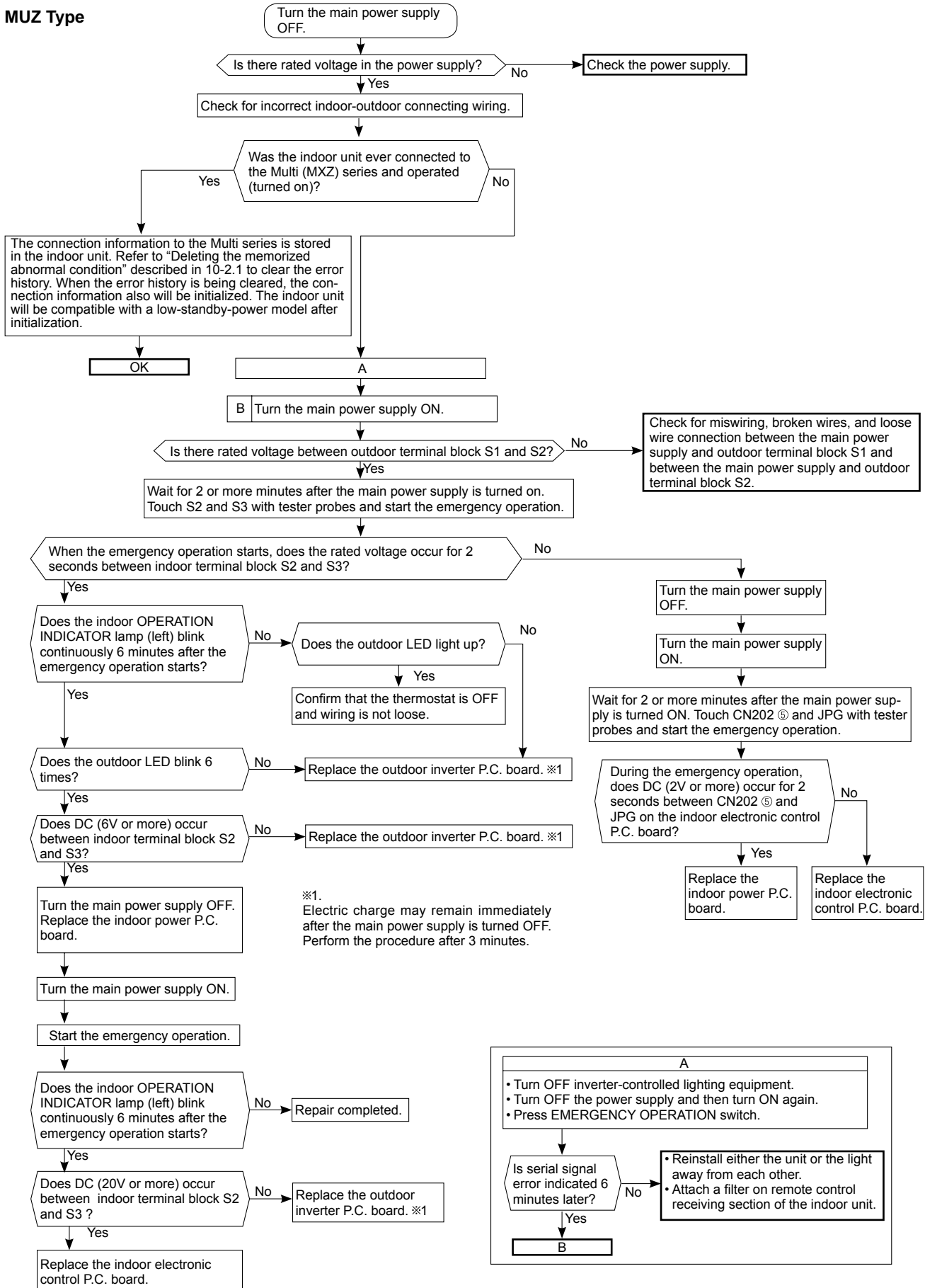

OBH600C

MXZ Type

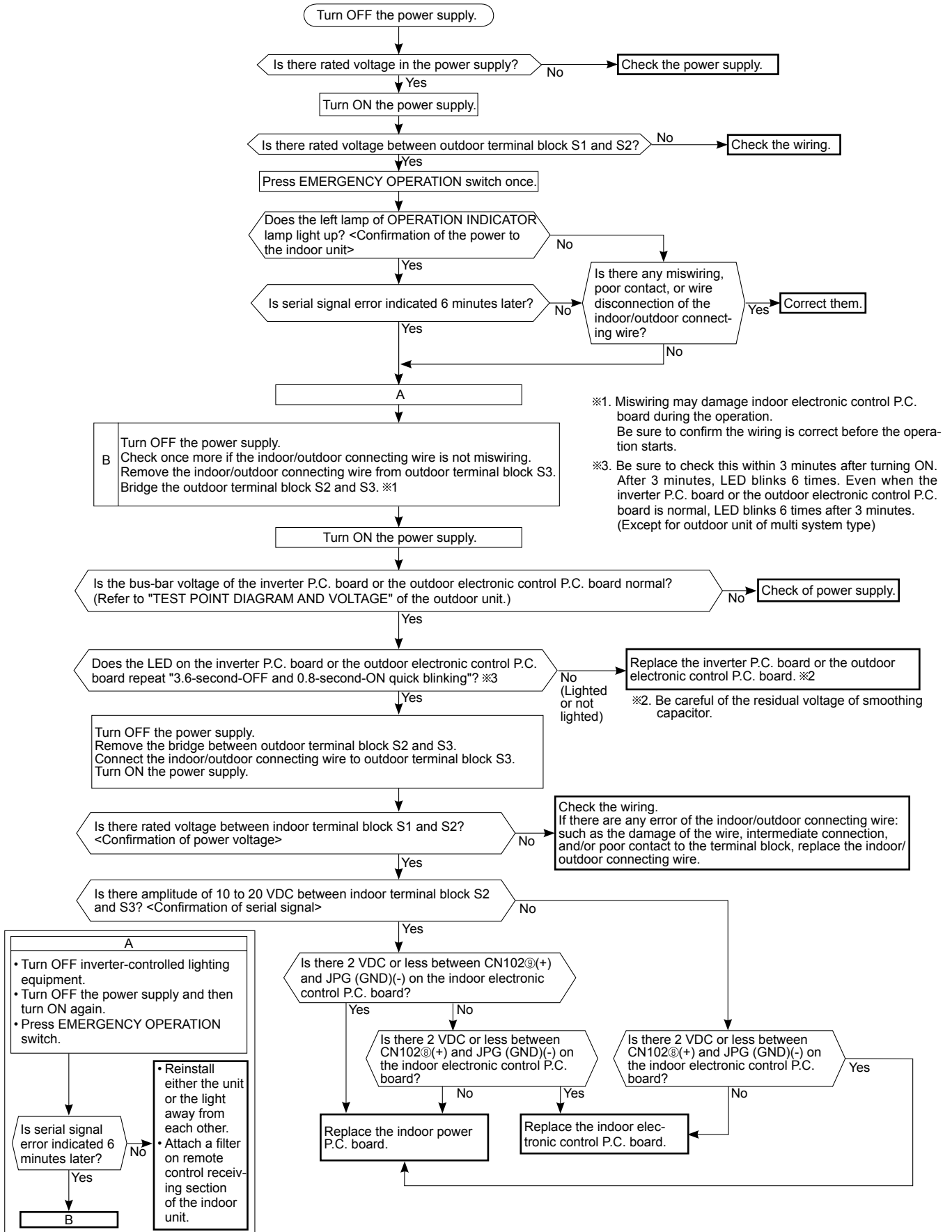

E Electromagnetic noise enters into TV sets or radios

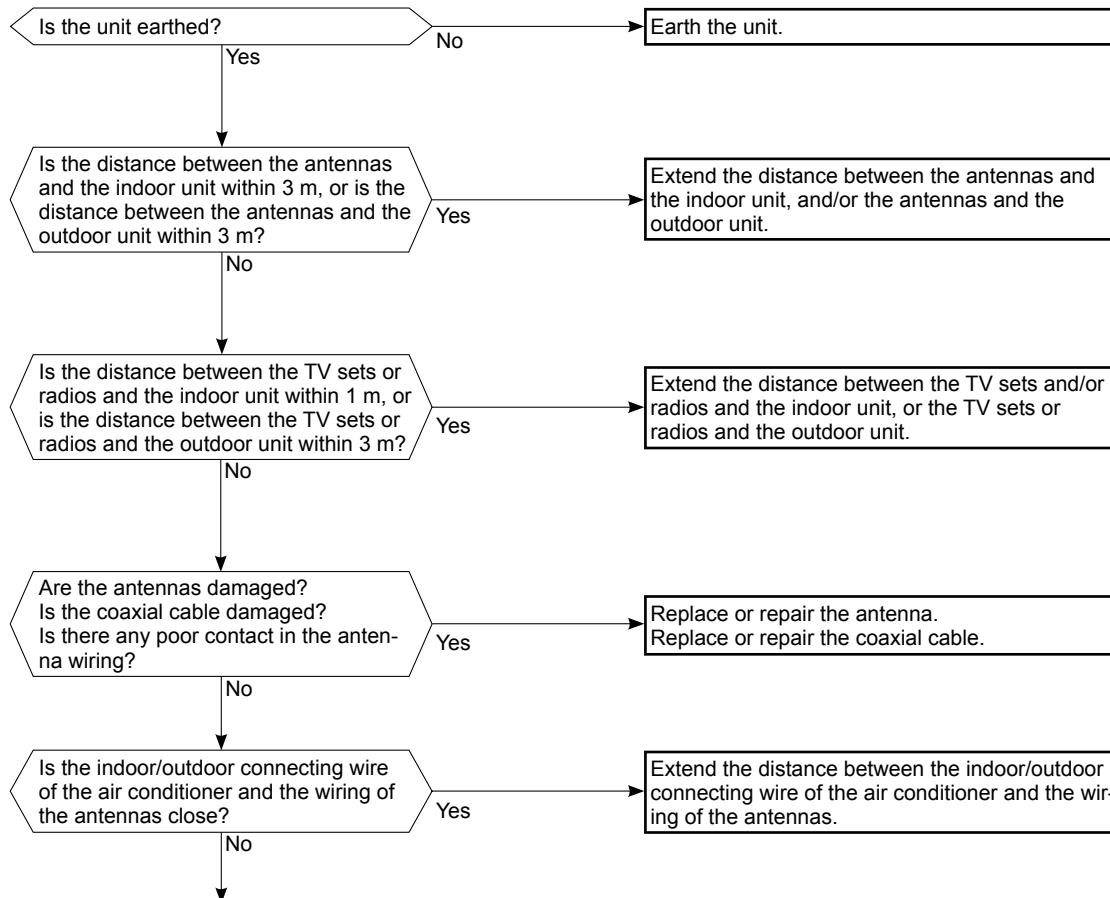

Even if all of the above conditions are fulfilled, the electromagnetic noise may enter, depending on the electric field strength or the installation condition (combination of specific conditions such as antennas or wiring). Check the following before asking for service.

1. Devices affected by the electromagnetic noise
TV sets, radios (FM/AM broadcast, shortwave)
2. Channel, frequency, broadcast station affected by the electromagnetic noise
3. Channel, frequency, broadcast station unaffected by the electromagnetic noise
4. Layout of:
indoor/outdoor unit of the air conditioner, indoor/outdoor wiring, earth wire, antennas, wiring from antennas, receiver
5. Electric field intensity of the broadcast station affected by the electromagnetic noise
6. Presence or absence of amplifier such as booster
7. Operation condition of air conditioner when the electromagnetic noise enters in
 - 1) Turn OFF the power supply once, and then turn ON the power supply. In this situation, check for the electromagnetic noise.
 - 2) Within 3 minutes after turning ON the power supply, press OPERATE/STOP (ON/OFF) button on the remote controller for power ON, and check for the electromagnetic noise.
 - 3) After a short time (3 minutes later after turning ON), the outdoor unit starts running. During operation, check for the electromagnetic noise.
 - 4) Press OPERATE/STOP (ON/OFF) button on the remote controller for power OFF, when the outdoor unit stops but the indoor/outdoor communication still runs on. In this situation, check for the electromagnetic noise.

<"Terminal with locking mechanism" Detaching points>

The terminal which has the locking mechanism can be detached as shown below.
 There are two types (Refer to (1) and (2)) of the terminal with locking mechanism.
 The terminal without locking mechanism can be detached by pulling it out.
 Check the shape of the terminal before detaching.

(1) Slide the sleeve and check if there is a locking lever or not.

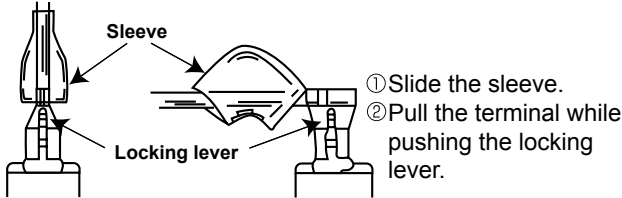

(2) The terminal with this connector has the locking mechanism.

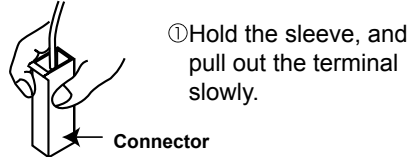

MSZ-SF25VE MSZ-SF35VE MSZ-SF42VE MSZ-SF50VE

NOTE: Turn OFF power supply before disassembly.

OPERATING PROCEDURE	PHOTOS
<p>1. Removing the panel (1) Remove the horizontal vanes.</p> <div data-bbox="124 981 686 1527" style="border: 1px solid black; padding: 5px;"> <p>Removal procedure Unlock the upper and lower vanes as shown in ① using a thin instrument. Then, remove the horizontal vanes in the direction of ②.</p> </div> <p>(2) Remove the screw caps of the panel. Remove the screws of the panel. (3) Unhook the lower part (A) of the panel. (4) Pull the panel slightly toward you, and then remove the panel by pushing it upward.</p>	<p>Photo 1</p>

OPERATING PROCEDURE

2. Remove the indoor electrical box

- (1) Remove the panel (Refer to 1.) and the corner box right.
- (2) Remove the screw of the V.A. clamp. Remove the V.A. clamp and the indoor/outdoor connecting wire.
- (3) Remove the earth wire connected to the indoor heat exchanger from the electrical box.
- (4) Remove the screw of the electrical cover and remove the electrical cover.
- (5) Disconnect following connectors:
 <Indoor electronic control P.C. board>
 CN151 (Vane motor)
 CN112 (Indoor coil thermistor)
 <Indoor power P.C. board>
 CN211 (Indoor fan motor)
- (6) Unhook the catch of the display P.C. board holder from the nozzle.
- (7) Remove the screw fixing the electrical box, then the upper catch of the electrical box, and pull out the electrical box.

※When installing the electrical box, pass the lead wire from the fan motor through ㊸ so that it will not be pinched under the electrical box.

3. Removing the indoor power P.C. board, the switch board, the display board, the receiver board and the indoor electronic control P.C. board

- (1) Remove the panel (Refer to 1.) and the corner box right.
- (2) Remove the screw of the V.A. clamp. Remove the V.A. clamp and the indoor/outdoor connecting wire.
- (3) Remove the indoor electrical box (Refer to 2.).
- (4) Remove the earth wire connected to the electrical box from the indoor power P.C. board.
- (5) Disconnect the following connectors:
 <Indoor electronic power P.C. board>
 CN201 (Terminal block)
 CN202 (To the indoor electronic control P.C. board)
- (6) Remove the indoor power P.C. board.
- (7) Disconnect the following connectors:
 <Indoor electronic control P.C. board>
 CN111 (Room temperature thermistor)
- (8) Unhook the catch of the display P.C. board holder from the electrical box (right side).
- (9) Open the rear cover of the display P.C. board holder and remove the switch board, the display board and the receiver board.
 Remove the indoor electronic control P.C. board.

PHOTOS

Photo 2

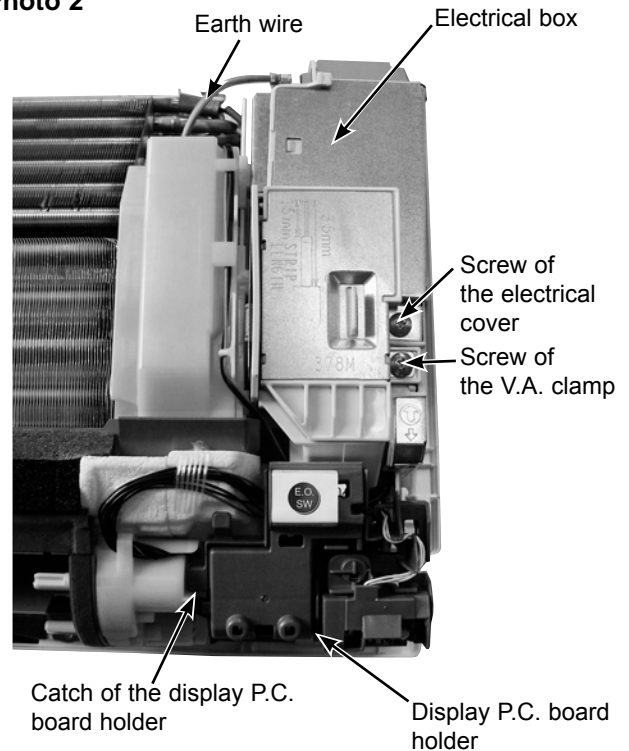
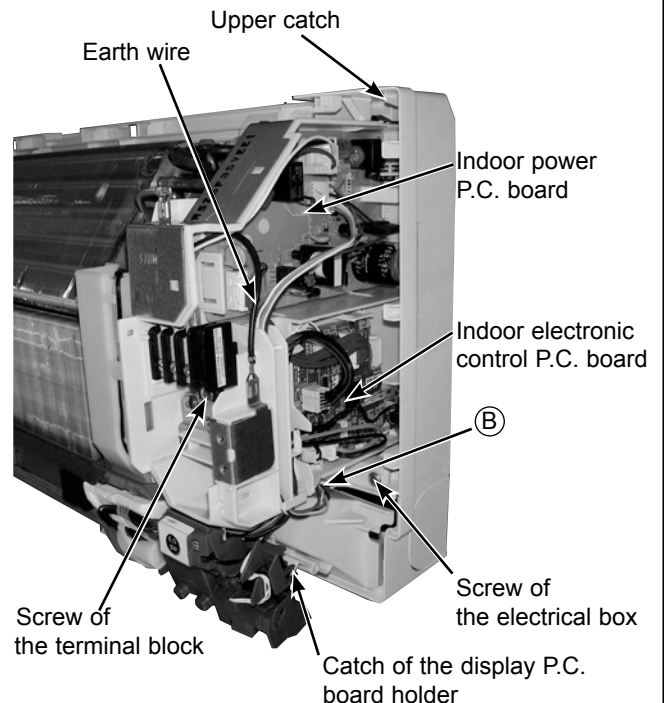

Photo 3



OPERATING PROCEDURE

4. Removing the nozzle assembly

- (1) Remove the panel (Refer to 1.) and the corner box right.
- (2) Remove the indoor/outdoor connecting wire (Refer to 2.).
- (3) Remove the electrical cover (Refer to 2.).
- (4) Disconnect the following connector:
<Indoor electronic control P.C. board>
CN151 (Vane motor)
- (5) Remove the display P.C. board holder.
- (6) Pull out the drain hose from the nozzle assembly and remove the nozzle assembly.
- (7) Remove the vane motors (Refer to 5.).

5. Removing the horizontal vane motor

- (1) Remove the nozzle assembly (Refer to 4.).
- (2) Remove the screws of the vane motor unit cover, and pull out the vane motor unit
- (3) Remove the screws of the vane motor unit.
- (4) Disconnect the connector from the vane motor.
- (5) Remove the vane motor from the vane motor unit.

PHOTOS

Photo 4

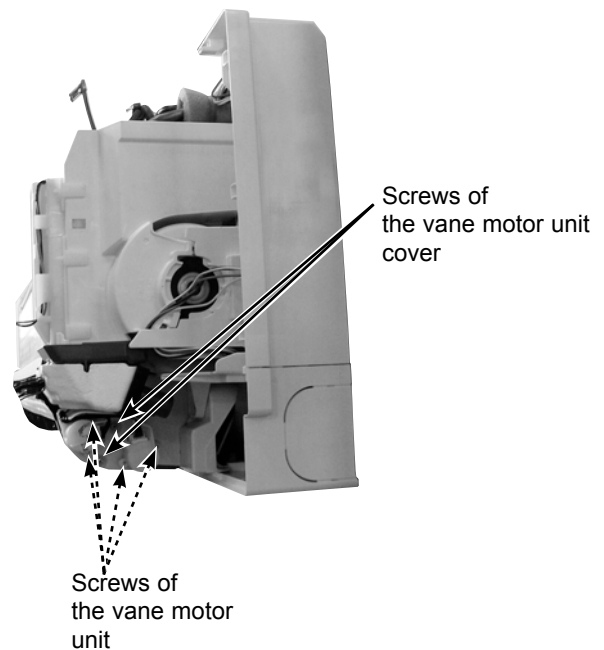

OPERATING PROCEDURE

6. Removing the indoor fan motor, the indoor coil thermistor and the line flow fan

- (1) Remove the panel (Refer to 1.) and the corner box right.
- (2) Remove the indoor electronic control P.C. board holder, the electrical box and the nozzle assembly.
- (3) Remove the screws fixing the motor bed.
- (4) Release the hooks of the water cut and remove the water cut.
- (5) Loosen the screw fixing the line flow fan.
- (6) Remove the motor bed together with the indoor fan motor and the motor band.
- (7) Release the hooks of the motor band and remove the motor band. Pull out the indoor fan motor.
- (8) Remove the indoor coil thermistor from the heat exchanger.
 - ※ Install the indoor coil thermistor in its former position when assembling it (Photo 5).
- (9) Remove the screws fixing the left side and the upper right side of the heat exchanger (Photo 7, Photo 5).
- (10) Lift the heat exchanger, and pull out the line flow fan to the lower-left.

PHOTOS

Photo 5

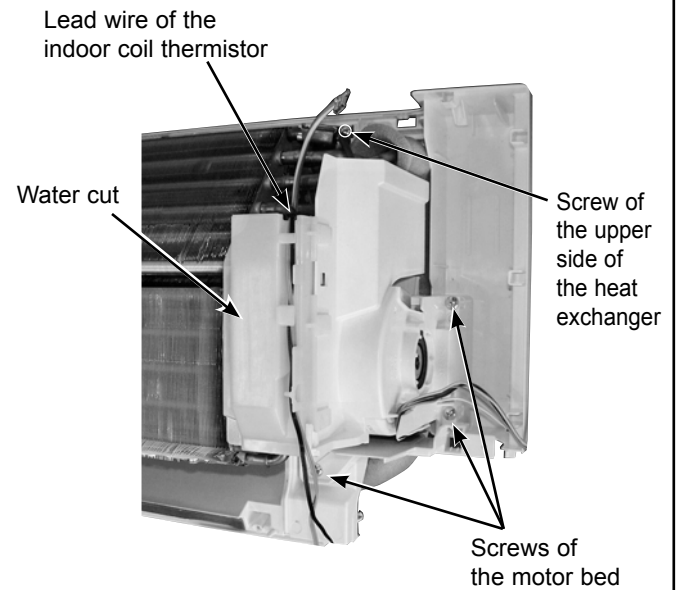

Photo 6

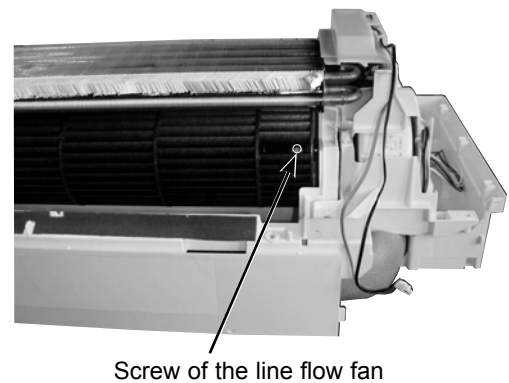
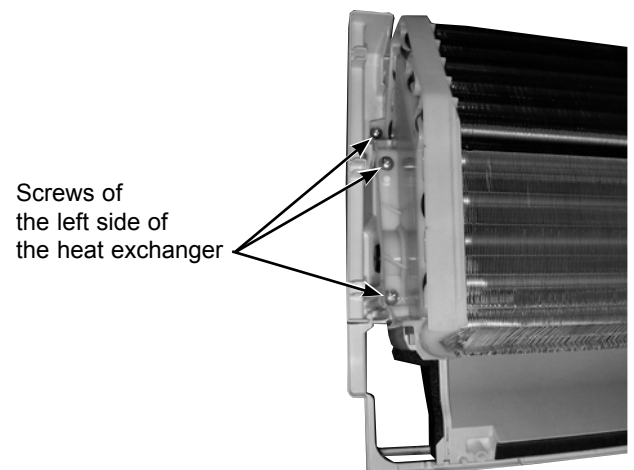

Photo 7



Fixing the indoor coil thermistor

※ There are 2 forms of parts for fixing the indoor coil thermistor.

Clip shape



Holder shape

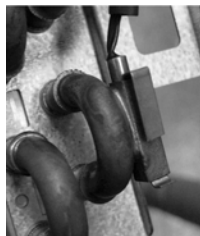

Position and procedure for mounting the clip-shape part

1. Set the indoor coil thermistor in the center of the clip-shape part.

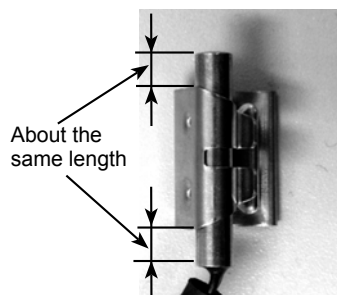

2. Check the (marked) mounting position.



3. Mount the clip-shape part.



NOTE:

- Take care to avoid loss and accidental falling of the clip-shape part inside the unit.
- Mount the clip-shape part on the marked position.
- Do not pull the lead wire when removing the indoor coil thermistor.

MITSUBISHI ELECTRIC CORPORATION

HEAD OFFICE: TOKYO BLDG., 2-7-3, MARUNOUCHI, CHIYODA-KU, TOKYO 100-8310, JAPAN

© Copyright 2011 MITSUBISHI ELECTRIC CORPORATION
Distributed in Dec. 2013. No. OBH600 REVISED EDITION-C
Distributed in Aug. 2013. No. OBH600 REVISED EDITION-B
Distributed in Nov. 2012. No. OBH600 REVISED EDITION-A
Distributed in Nov. 2011. No. OBH600
Made in Japan

New publication, effective Dec. 2013
Specifications are subject to change without notice.