

Royal Sovereign LAMINATORS

OWNER'S MANUAL

RSC-1650H/1650C



PLEASE READ AND SAVE INSTRUCTIONS

TABLE OF CONTENTS

TOPICS	PAGE
INSTRUCTION -----	3
SAFETY PRECAUTIONS -----	3
CHARACTERISTICS -----	4
SPECIFICATIONS -----	4
NAMES OF MAJOR PARTS OF MACHINE-----	5
SETTING UP FILM -----	6
HANGING FILM -----	7
CONTROL OF ROLLER PRESSURE -----	8
INSTRUCTIONS FOR CONTROL PANEL -----	9
1.FUNCTIONS OF CONTROL PANEL -----	10
2.HOW TO USE BUTTONS -----	10
LAMINATING STEPS -----	11
METHOD FOR USING CUTTER -----	12
1.CROSS CUTTER -----	12
IMPORTANT SAFETY CONCERNS -----	13
MAINTENANCE -----	13
IT'S NOT OUT OF ORDER -----	14
ASSEMBLY PARTS -----	14
WARRANTY -----	15

INSTRUCTION

Thank you for purchasing a Royal Sovereign Roll Laminator. It has been designed and manufactured to provide years of continuous service in the professional environment. To insure high quality lamination, please read this instruction manual thoroughly. This manual will provide you with complete operating and maintenance information.

SAFETY PRECAUTIONS

The safety recommendations outlined in this section are to be read, understood and followed before operating machine. keep this information for future reference. Failure to comply any of the following safety procedures could result in serious personal injury.

1. To prevent the possibility of electrical shock, do not immerse machine in water or permit liquids to spill inside.
2. Do not allow articles of clothing (neckties, scarves, papers, etc.) near front or rear machine openings as they could get caught by rollers and be pulled inside, causing personal injury.
3. Do not insert sharp objects into front or rear machine openings. Do not place anything in feed tray openings of machine other than appropriate laminating materials or pouches
4. Do not attempt to laminate items that exceed total recommended material thickness.
5. Do not operate machine for any other purposes than its intended use.
6. Do not operate machine if electrical plug or power cord is damaged.
7. Turn off the power when unattended or not in use. Unplug machine before moving it or when it is not in use for an extended period of time.
8. This machine is intended for indoor use only.
9. Do not alter or extend electric plug. Plug is configured for appropriate electrical supply.
10. The socket-outlet shall be installed near the equipment and shall be easily accessible.

CHARACTERISTIC

RS Roll Laminator Line is advanced laminators with time transcendental design, utilizing the latest in laminating technology.

It is designed for you to set temperature and speed as necessary. Also you can laminate anything at high speed, regardless of thickness of material and type of film. It is also designed for convenient use by anyone through the simple procedure of adjusting film tension in accordance with the thickness of film and materials to be laminated.

SPECIFICATIONS

Description	RSC-1650H	RSC-1650C
Power Supply	120V/60Hz	120V/60Hz
Power Consumption(Watts)	1700	100
Max. Laminating Width(mm)	1650(65")	1650(65")
Laminating Thickness(micron)	25,50,75,80,100,...	
Laminating Speed(mm/min)	5000(16.4ft/min)	
Ready time(min)	10	—
Heating Method	Warm Roller	no
Temp` Select	9 step	
Temp` Control	digital	
Speed Control	9 step (digital)	
Driving Motor	DC Geared Motor	
Transport Type	2 Roller	
Cooling System	no	
Hot Lamination	no	
Photo Lamination	yes	
Mount Lamination	yes(15mm)	
Reverse	yes	
Stand-by mode	no	
Power auto-off	no	
Foot switch	yes	
Remote switch	yes	
Laminating Length Measurement	no	
Laminating Paper Counting	no	
Dimension(W×D×H,mm)	1960×650×1210 (77.2"×25.6"×47.4")	
Unit Weight	230Kg(500ibs)	
Gross Demension(W×D×H,mm)	2100×875×1250 (82.7"×34.1"×49.2")	
Gross Weight	300Kg(660ibs)	

NAMES OF MAJOR PARTS OF MACHINE



NO	PART NAME	RSC-1650H	RSC-1650H
1	FRAME-GUIDE,PAPER		<input type="radio"/>
2	TAKE-UP SWITCH		<input type="radio"/>
3	TAKE-UP BOBBIN		<input type="radio"/>
4	IDLE BAR		<input type="radio"/>
5	TABLE-FRONT		<input type="radio"/>
6	HOT ROLLER	UPPER ROLLER	<input checked="" type="radio"/>
7	ASS'Y-STAND		<input type="radio"/>
8	CONTROL PANEL		<input type="radio"/>
9	PRESSURE LEVER		<input type="radio"/>
10	TENSION CONTROL KNOB		<input type="radio"/>
11	SAFETY COVER		<input type="radio"/>
12	FOOT SWITCH		<input type="radio"/>
13	REMOCON SWITCH		<input type="radio"/>

SETTING UP FILM

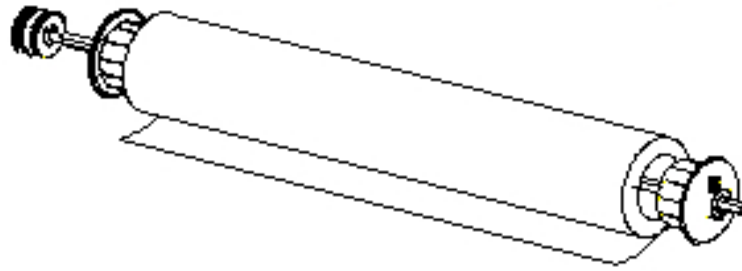

COLD FILM

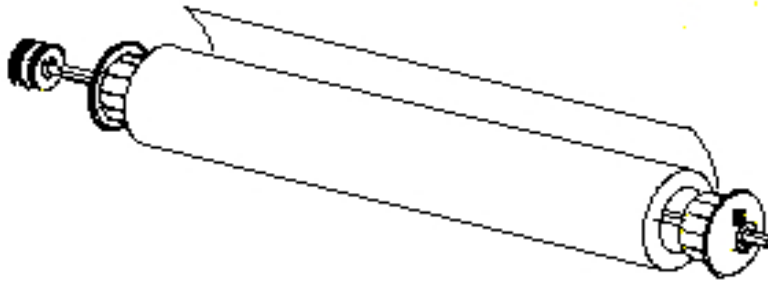

PAPER BACK

1. Set the glossy side of upper/lower film to face the heat.
(Glossy side is PET film and matte side is thermal polymer laminating film.)
2. Like picture 1, insert core into the left side of upper/lower film shaft.
3. Like picture 2 and 3, insert core into the right side of upper/lower film.
4. Like picture 4 and 5, adhere core closely.
(Make the right/left direction of fixing screw consistent.)
5. Locate film in the middle, and then fasten core fixing screw.

HANGING FILM

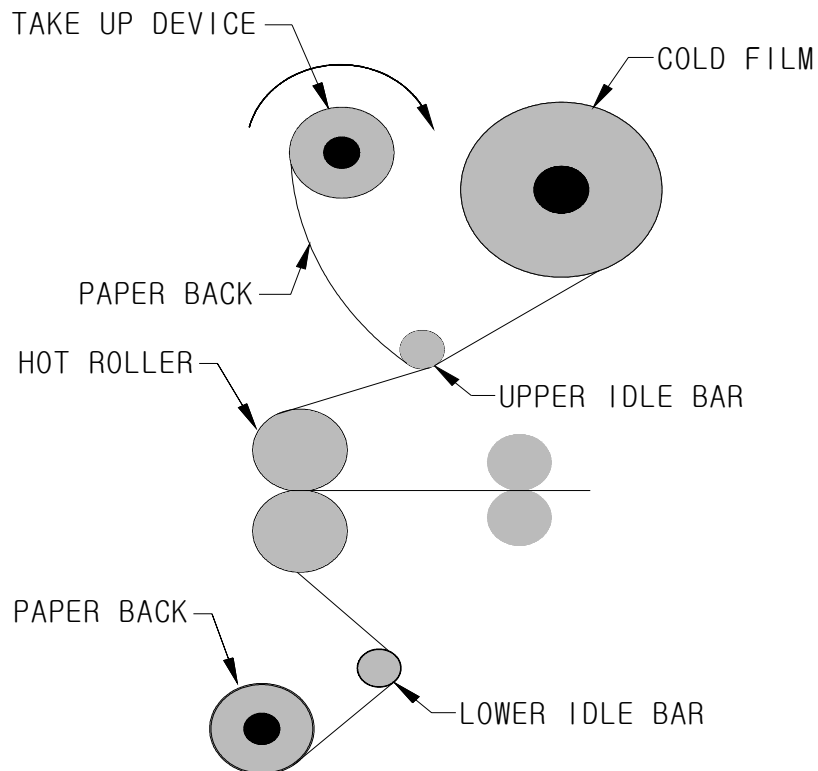

1. Set up cold film below the upper bar of the machine.
(Set the same as method of the HOT film for protect paper of lower part)
2. Set the pressure lever to the 15mm, open mode.
3. Insert a piece of wide cardboard (guiding paper/carrier) between the rollers.
4. Pull the film from the upper roller passing over the upper idle bar to the upper roller and put it on the upper roller.
5. Put the paper back of the film to the bobbin at take-up bar to rewind the paper back.
6. Allow some of the film with melted resin to stick to the Guiding Paper.
7. Place the film from lower shaft beneath the film from the upper roller which is already melting. and unwind films of both rollers 30~40cm(1~1.3ft) for loosening the tension.
8. Set the pressure lever to the 1mm.
9. Set speed at 1 and press the RUN button. The films will be fed into the machine and will come out from the rear site of machine.
10. Check the status of lamination and place the pressure lever at lamination mode.

CONTROL OF ROLLER PRESSURE

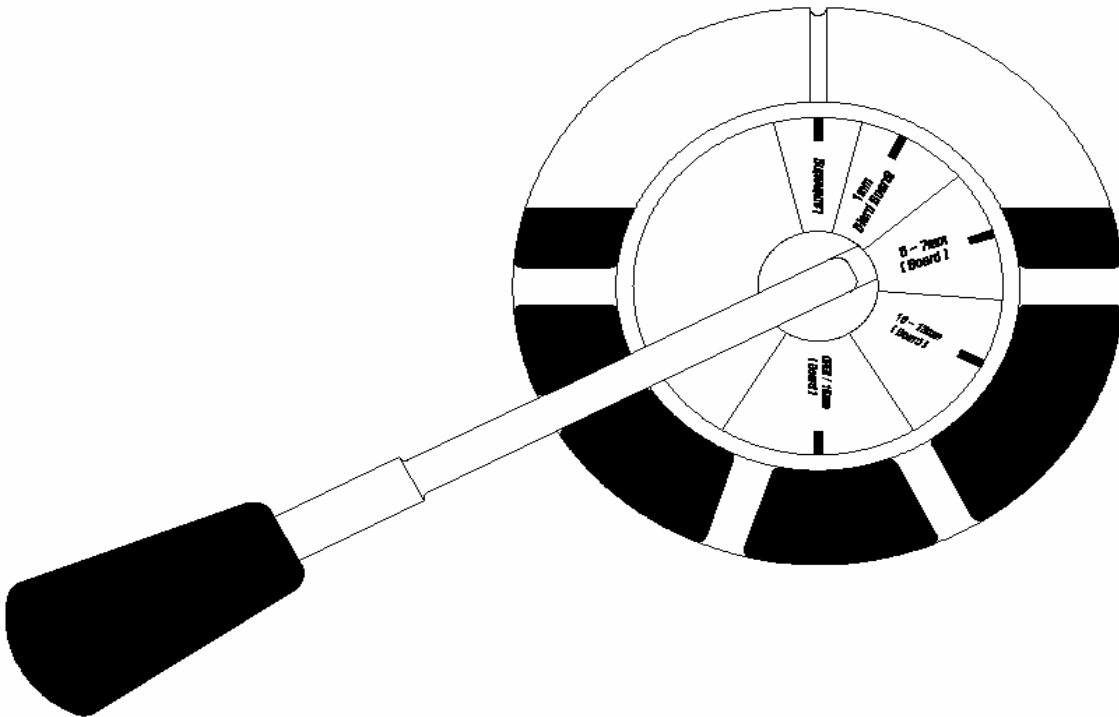

***Methods of controlling pressure of the roller**

1. For setting, pull the pressure lever out and turn the lever to following the indication
2. OPEN/15mm(Board) : For laminating 15mm thick board (RSC-1650H/1650C)
3. 10~13mm(Board) : For laminating 10~13mm thick board
4. 5~7mm(Board) : For laminating 5~7mm thick board
5. 1mm(Hard Board) : For laminating 1mm thick board
6. Laminating : For laminating 32~250micron thick film

INSTRUCTIONS FOR CONTROL PANEL

We designed this machine standing by user's convenience. You can manipulate speed and temperature .



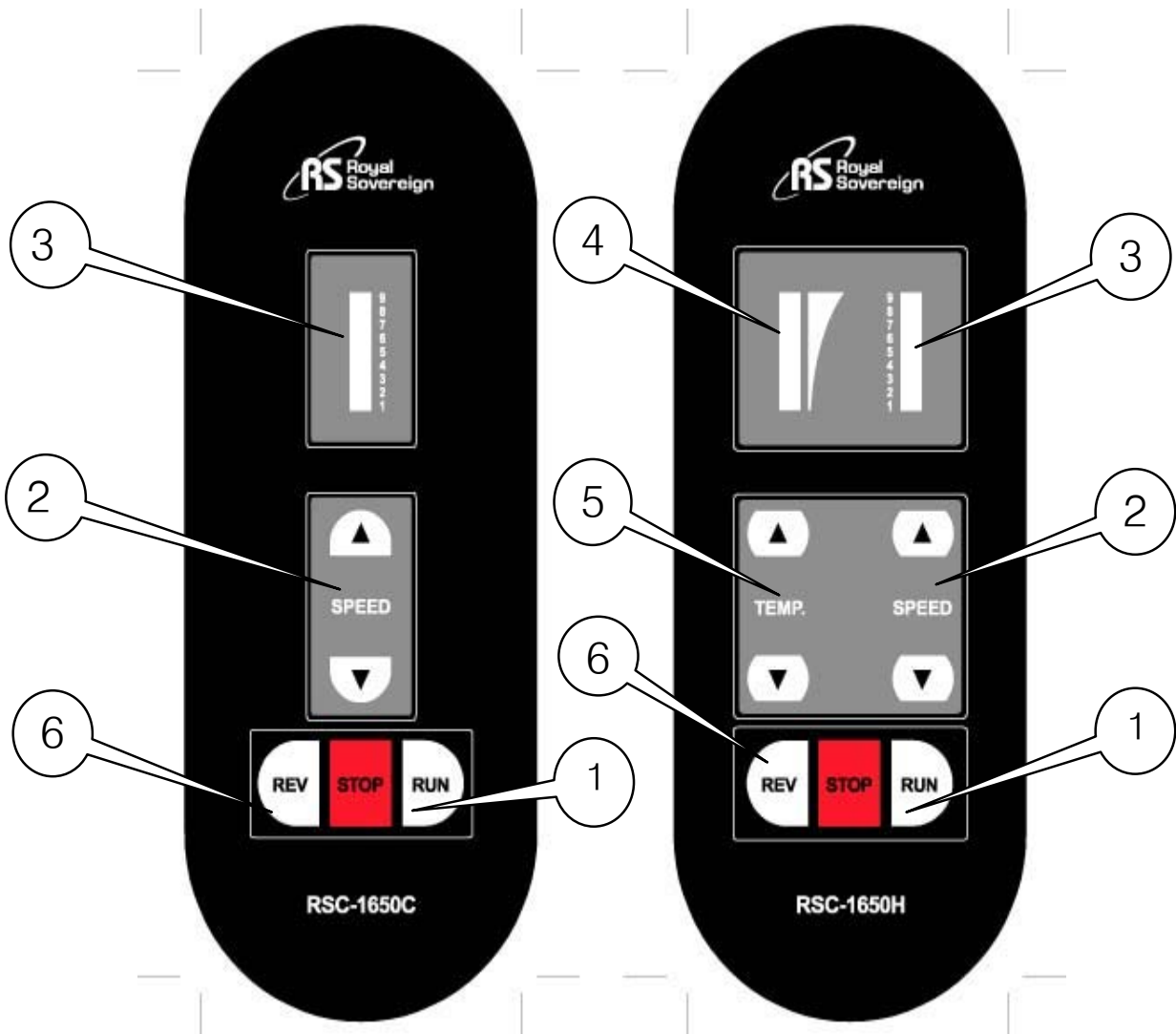



Terms





1. FUNCTIONS OF CONTROL PANEL

- 1 **RUN/STOP BUTTON** : Run or stop the rollers
- 2 **SPEED BUTTON** : Increase or decrease speed
- 3 **LED OF SPEED** : Display or speed
- 4 **LED OF TEMP.** : Display temperature
- 5 **TEMP.BUTTON** : Increase or decrease temperature
- 6 **REVERSE BUTTON** : To make the rollers run backward

2.HOW TO USE BUTTONS

- 1 **RUN / STOP BUTTON**
Push the  button in order to run rollers and push  button to stop it.
- 2 **SPEED BUTTON**
Push the SPEED button  to increase the speed,push the speed button  to decrease the speed.
- 5 **TEMP. BUTTON**
Push the TEMP. button  to increase the temperature,push the TEMP. button  to decrease.
- 6 **REVERSE BUTTON** 
Stay pressing REVERSE button to have . The roller run backward.

LAMINATING STEPS

1. Put cold roll film on upper bar.(Set the same as method of the HOT film for protect paper of lower part)
2. Pull COLD film, and fix it so that backside protecting paper can be wound on take-up mandrel clockwise. (Revolve core to make protecting paper tight a little bit.)
3. Set pressure lever at the proper position following to your lamination condition.
4. After pressing the **RUN/STOP** button choose and set proper speed by using the SPEED button  or .
5. Turn on the take up device and set the proper film tension by pressing the RUN/STOP button. Lower tension would make better operation.

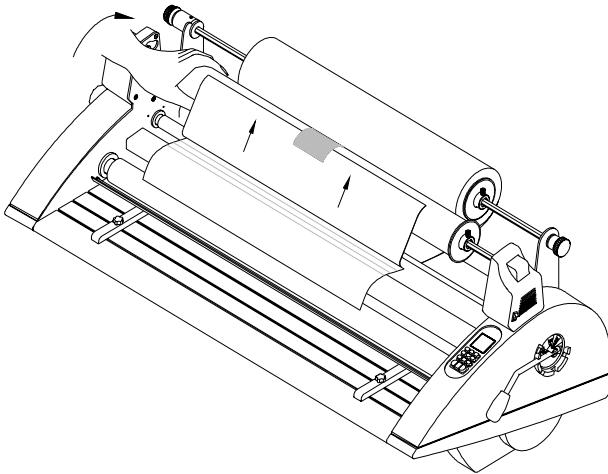

10. Set pressure lever at the Hard board/15mm mode.
11. Turn off the power switch.

*** Reference ***

1. Set up the protection paper. Otherwise, glue from the film will be stuck on the face of roller and it can be seriously damaged.
2. Turn the switch **RUN/STOP** and “Take up motor” at the same time.

METHOD FOR USING CUTTER

****Cross Cutter****

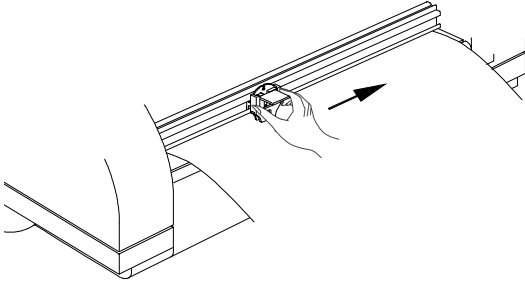

1. It is on the back side of the machine.

2. After lamination, move cutter to a point about 1/3 of the width of lamination.

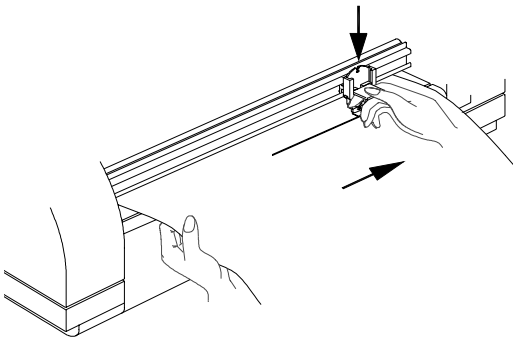

3. Grasp film with one hand and press the cutter, cutter downward and slide it to the direction intending to cut with another hand.

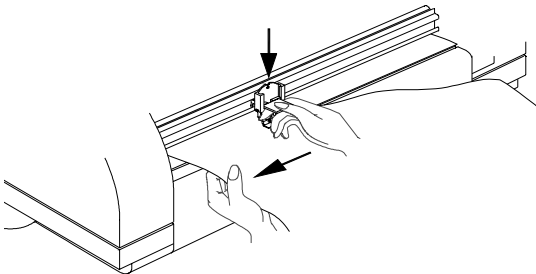

4. Press the cutter and slide it the other way.

IMPORTANT SAFETY CONCERNS

1. Please be cautious that neck tie, necklace, long hair, clothes are kept well away while operation.
2. Prevent children from accessing the machine Extreme Heat Will Cause Injury
3. Place the machines on the plated place in order to prevent the machine from damage.
4. Make certain that the machine is connected to an adequate power source.
5. Do not use any other purposes other than Lamination.



MAINTENANCE

1. Do not allow the machine to run with only one roll of film installed. The melted resin will adhere to one roller and ruin future laminations.
2. The width of film should be bigger than the material, and Width of upper side and lower side of film should be same in order not to allow melted resin to adhere to the rollers.
3. Be sure to adjust the film tension while in operation. If the tension is too tight, it could cause the film to stretch.
4. After work, you should clean the resin from the rollers before beginning the next operation
5. Please check the lubricant after long operation or you do not use for a long time.
6. Check the chain linking each gear is not loosened. The limit tension allowed is 3mm.

It's not out of order

Symptom	Cause	CHECK POINT
*Rollers do not operate after press RUN button	1. Power cord may not be plugged in. 2. Power switch is at OFF mode. 3. Emergency switch may be at ON mode. 4. The safety cover is opened.	1. Check the power cord. 2. Check if the switch is on. 3. Check if the emergency switch is off. 4. Check the s/w of safety cover is right.
*Wrinkled lamination result	1. Film tension is not proper, too tight.	1. Adjust film tension.

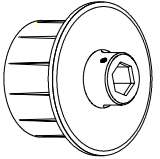
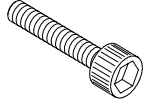
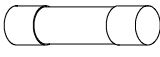
ASSEMBLY PARTS

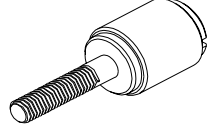
PART NAME	EA	MODEL	PART NAME	EA	MODEL
Core(76mm) 	10	RSC-1650H RSC-1650C	Bolt(M8X12) 	6	RSC-1650H RSC-1650C
FUSE(50T) (AC250V 6.3A) 	1		Washer(Φ8) 	6	
FUSE(65TS) (AC250V 20A) 	1		BOLT CORE 	8	

WARRANTY

1. For six month from the date of purchase, Royal Sovereign International Corporation or its authorized service center will repair this product free of charge if it is defective in material or workmanship.
2. This Limited Warranty does not include cleaning, or damage caused by accident, neglect, misuse or improper installation, operation or external scratch, any damage caused from service, maintenance, modifications or tampering by anyone other than a Sovereign authorized service representative, or damage caused by a natural calamity such as fire or earthquake and etc...
3. Customers will bear the expense of Transportation fee and delivery fee of the damaged machine.