

**Instruction 510-0087**  
**09-30-13**

Copyright © 2013  
by S&S® Cycle, Inc.

All rights reserved.  
Printed in the U.S.A.

**S&S® Cycle, Inc.**

**14025 Cty Hwy G PO Box 215**  
**Viola, Wisconsin 54664**

Phone: 608-627-1497 • Fax: 608-627-1488  
Technical Service Phone: 608-627-TECH (8324)  
Technical Service Email: [sstech@sscycle.com](mailto:sstech@sscycle.com)  
Website: [www.sscycle.com](http://www.sscycle.com)



## **Installation Instructions:** **S&S® Piston and Cylinder Kits** **for all 1986-up Harley-Davidson® Sportster® Models**

### **DISCLAIMER:**

S&S parts are designed for high performance, closed course, racing applications and are intended for the very experienced rider only. The installation of S&S parts may void or adversely affect your factory warranty. In addition such installation and use may violate certain federal, state, and local laws, rules and ordinances as well as other laws when used on motor vehicles used on public highways, especially in states where pollution laws may apply. Always check federal, state, and local laws before modifying your motorcycle. It is the sole and exclusive responsibility of the user to determine the suitability of the product for his or her use, and the user shall assume all legal, personal injury risk and liability and all other obligations, duties, and risks associated therewith.

The words Harley®, Harley-Davidson®, H-D®, Sportster®, Evolution®, and all H-D part numbers and model designations are used in reference only. S&S Cycle is not associated with Harley-Davidson, Inc.

### **SAFE INSTALLATION AND OPERATION RULES:**

Before installing your new S&S part it is your responsibility to read and follow the installation and maintenance procedures in these instructions and follow the basic rules below for your personal safety.

- Gasoline is extremely flammable and explosive under certain conditions and toxic when breathed. Do not smoke. Perform installation in a well ventilated area away from open flames or sparks.
- If motorcycle has been running, wait until engine and exhaust pipes have cooled down to avoid getting burned before performing any installation steps.
- Before performing any installation steps disconnect battery to eliminate potential sparks and inadvertent engagement of starter while working on electrical components.
- Read instructions thoroughly and carefully so all procedures are completely understood before performing any installation steps. Contact S&S with any questions you may have if any steps are unclear or any abnormalities occur during installation or operation of motorcycle with a S&S part on it.
- Consult an appropriate service manual for your motorcycle for correct disassembly and reassembly procedures for any parts that need to be removed to facilitate installation.
- Use good judgment when performing installation and operating motorcycle. Good judgment begins with a clear head. Don't let alcohol, drugs or fatigue impair your judgment. Start installation when you are fresh.
- Be sure all federal, state and local laws are obeyed with the installation.
- For optimum performance and safety and to minimize potential damage to carb or other components, use all mounting hardware that is provided and follow all installation instructions.
- Motorcycle exhaust fumes are toxic and poisonous and must not be breathed. Run motorcycle in a well ventilated area where fumes can dissipate.

### **IMPORTANT NOTICE:**

Statements in this instruction sheet preceded by the following words are of special significance.



#### **WARNING**

Means there is the possibility of injury to yourself or others.

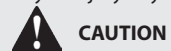

#### **CAUTION**

Means there is the possibility of damage to the part or motorcycle.

#### **NOTE**

*Other information of particular importance has been placed in italic type.*

*S&S recommends you take special notice of these items.*

### **WARRANTY:**

All S&S parts are guaranteed to the original purchaser to be free of manufacturing defects in materials and workmanship for a period of twelve (12) months from the date of purchase. Merchandise that fails to conform to these conditions will be repaired or replaced at S&S's option if the parts are returned to us by the purchaser within the 12 month warranty period or within 10 days thereafter.

In the event warranty service is required, the original purchaser must call or write S&S immediately with the problem. Some problems can be rectified by a telephone call and need no further course of action.

A part that is suspect of being defective must not be replaced by a Dealer without prior authorization from S&S. If it is deemed necessary for S&S to make an evaluation to determine whether the part was defective, a return authorization number must be obtained from S&S. The parts must be packaged properly so as to not cause further damage and be returned prepaid to S&S with a copy of the original invoice of purchase and a detailed letter outlining the nature of the problem, how the part was used and the circumstances at the time of failure. If after an evaluation has been made by S&S and the part was found to be defective, repair, replacement or refund will be granted.

### **ADDITIONAL WARRANTY PROVISIONS:**

- (1) S&S shall have no obligation in the event an S&S part is modified by any other person or organization.
- (2) S&S shall have no obligation if an S&S part becomes defective in whole or in part as a result of improper installation, improper maintenance, improper use, abnormal operation, or any other misuse or mistreatment of the S&S part.
- (3) S&S shall not be liable for any consequential or incidental damages resulting from the failure of an S&S part, the breach of any warranties, the failure to deliver, delay in delivery, delivery in non-conforming condition, or for any other breach of contract or duty between S&S and a customer.
- (4) S&S parts are designed exclusively for use in Harley-Davidson® and other American v-twin motorcycles. S&S shall have no warranty or liability obligation if an S&S part is used in any other application.

1. Remove the cylinder heads, cylinders, and pistons according to the procedures in the Harley-Davidson® service manual.
2. For 2004-up models – prior to installing the new S&S pistons and cylinders, move tappet covers as far as possible toward the outside of the engine (away from the cylinders) to ensure adequate clearance between the tappet covers and cylinder bases.
  - a. Remove tappet covers from crankcase
  - b. Clean tappet covers, reusable gaskets, crankcase gasket surface, and hardware with solvent and a clean rag.
  - c. Apply blue thread locking compound to tappet cover screws.
  - d. Reinstall tappet cover gaskets, covers, and screws, but do not final tighten.
  - e. Hold the tappet cover as far away from the cylinders as possible. **See Picture 1, below.**
  - f. Torque screws to 120 In\*lb in a criss-cross pattern.



**Picture 1**

### 3. Install S&S Pistons

**NOTES:**

- These S&S piston can be used in either the front or rear position. However, when purchased in a kit with cylinders, each piston must be kept with the cylinder it was delivered in, as each cylinder is individually honed to fit a specific piston.
- Rebalancing is not required when installing this kit.

- a. Clean pistons and wrist pins with solvent.

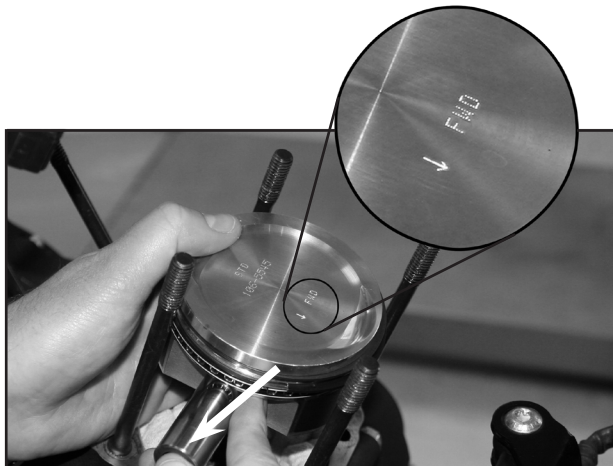

**Picture 2**

Suggested ring end gaps			
Ring	Ring Gap Tolerance (inches)		Target Gap
	Min	Max	
Top	0.016	0.022	0.017
2nd	0.016	0.026	0.021
Oil ring rails	0.010	0.050	0.010 to 0.050

**NOTE:** Wristpin must be thoroughly cleaned before installation, paying particular attention to bore. Pass clean, lint-free cloth back and forth through wristpin bore several times to insure removal of all contaminants.

- b. Apply assembly lube to connecting rod bushings, wristpins, and piston wristpin holes.
- c. Install pistons with the FWD arrow mark pointing toward the front of the engine. **See Picture 2, below, left.**
- d. Ensure that wristpin clip groove in piston is free of burrs and foreign matter. Install wire clips using procedure recommended in a Harley-Davidson® service manual. End of clip must rest over notch in piston below wristpin hole to allow removal of clip in future. Be sure clip is fully seated in groove.

**NOTE:** Round "wire" style clips supplied with this kit are identical to and interchangeable with stock clips in Harley-Davidson® Evolution® engines.

### 4. Install Piston Rings

**NOTE:** Ring widths on some piston series may change from time to time. Part numbers of rings originally supplied with pistons should be recorded for future reference in the event replacement rings are required.

- a. Measure ring end gap by pushing ring about 1 inch into the cylinder bore from the head end of the cylinder, using the piston to insert the ring squarely in the bore. **See Picture 3, below.** Measure the gap between the ends of the ring with a feeler gauge. **See Picture 4, next page.** Compression ring end gap should be between .016" to .026". Oil ring rail end gap should be between .010 to .050". If there is insufficient ring end gap, file the end of the piston ring to achieve the desired gap. Ends of piston ring must be deburred after filing.
- b. Thoroughly clean the piston rings after filing and deburring and install on pistons.

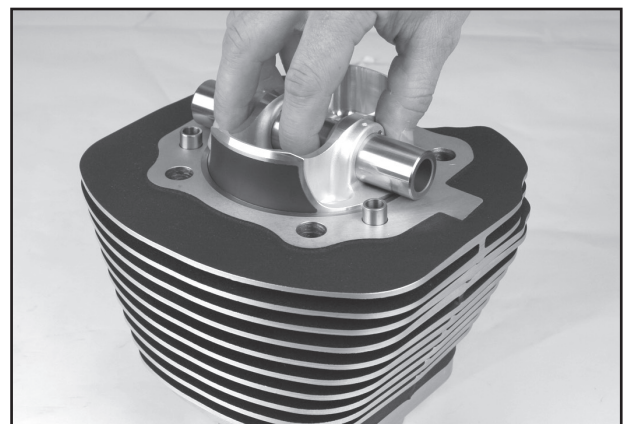

**Picture 3**

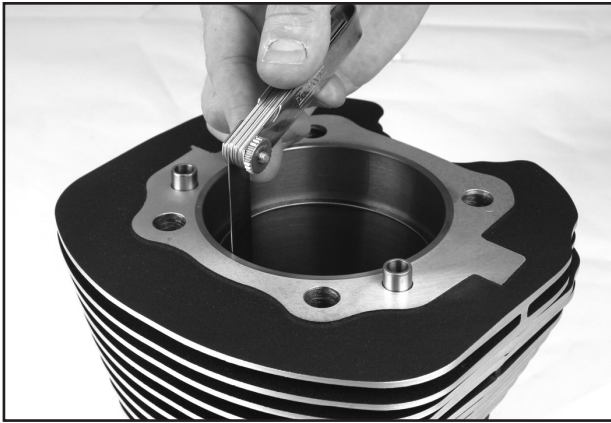

Picture 4

c. Install Oil rings (See Figure 4, page 4)

1. Install the oil ring expander in the bottom groove of the piston. The expander ring has a gold finish. Make sure the ends of the expander ring are pointed upward and butted together. Ends must not overlap (See Figure 1, above left). If the tips are overlapped, excessive oil consumption will occur.
2. Bottom rail gap should be approximately 1.5" or 45° to right of expander gap.
3. Top rail gap should be approximately 1.5" or 45° to left of expander gap.

**NOTE:** Confirm that ends of expander do not overlap during installation. Properly installed expander will appear larger than piston but will compress when cylinder installed. In some cases, same expander is used for several bore sizes. Oversize rings will not necessarily have a larger expander.

d. Install compression rings observing the following:

- Second compression ring is cast iron regular or reverse torsion type. This ring has a darker, charcoal gray finish.
- Top compression ring may be either moly faced or chrome faced. This ring has a gray finish that is relatively light in color.
- Any identifying "pip" marks, dots or oversize marks go to top of piston.
- If ring has dot and inside diameter bevel, dot goes to top of piston. **See Figure 2, below.**
- If ring has no dot but does have inside diameter bevel, bevel goes to top of piston. **See Figure 3, below.**
- If ring has no dots and no bevel, it can go either way. **See Figure 4, below.**

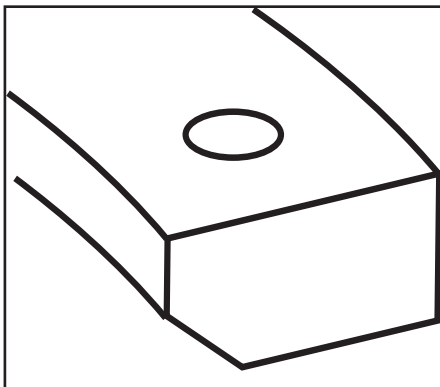

Figure 2

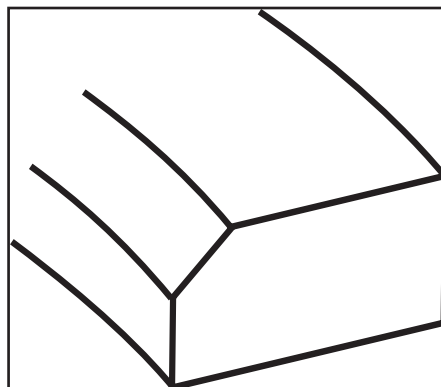

Figure 3

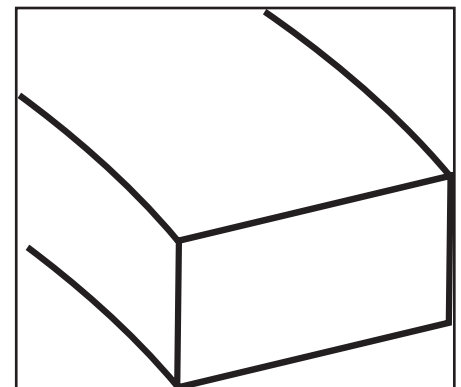

Figure 4



Figure 1

- Second compression ring gap should be 135° or approximately 4½" to right of oil expander gap. (See Figure 5, next page).
- Top compression ring gap should be 135° or approximately 4½" to left of oil expander gap. (See Figure 5, next page)

**CAUTION**

**Failure to remove burrs from piston ring ends after filing to size, may cause engine damage. Incorrect installation of rings may result in poor performance, excessive oil consumption or engine damage.**

5. Reassemble cylinders, cylinder heads, pushrods, and fuel system according to procedures in the Harley-Davidson® service manual or in instructions included with any aftermarket components used. If high performance cams are installed, valve to piston clearance must be checked.

**NOTE:** In all cases it is the engine builder's responsibility to confirm proper clearances when assembling an engine. This is especially critical with performance components such as higher compression pistons and high lift camshafts. In addition to clearances mentioned, .060" valve-to-piston clearance must be confirmed.

**CAUTION**

**Failure to establish proper clearances can result in severe engine damage not covered under warranty.**

6. Engine Break-In Procedure

**NOTE:** S&S® engine kits are designed for high performance and as such are not as tolerant of inadequate break-in as a stock engine. Correct break-in will assure longer engine life and will prevent unnecessary engine damage. Engine damage caused by improper break-in is not covered under the S&S warranty.

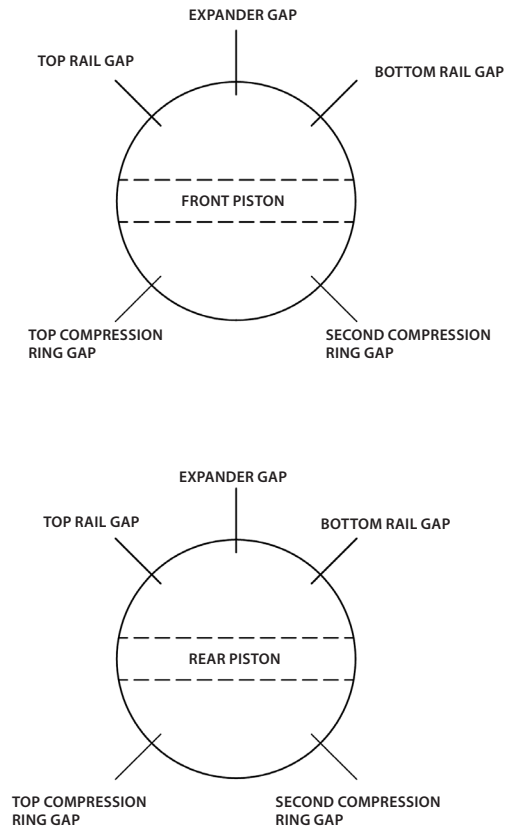

**Figure 5: GAP PLACEMENT ILLUSTRATION**

- Initial start up. Run engine approximately one minute at 1250-1750 rpm. DO NOT crack throttle or subject to any loads during this period as head gaskets are susceptible to failure at this time. During this time check to see that oil pressure is normal, that oil is returning to the oil tank, and that no leaks exist.
- Shut off engine and thoroughly check for any leaks or other problems. Let engine cool to the touch
- After engine has cooled, start up again and allow the motor to build some heat. Engine should be run no longer than three to four minutes. When the cylinders become warm/hot to the touch (approximately 150°) shut the motor down and let it cool to room temp. Follow the same cautions as for the initial start-up, and continue to watch for problems.
- Repeat this procedure 3 or 4 times. Each successive time it should take slightly longer to warm up and you can increase the temp slightly each time (+10°). You can be more liberal each time with the rpm, gently vary rpm continuously from idle up to 2500 rpm in the final cycle. Don't be too concerned with final carb settings at this time because idle speed and mixture cannot be correctly set until the motor reaches full operating temperature. The motor should not reach that temperature during these cycles. Do not allow engine temperature to become excessive. After the motor has cooled to room temperature for the final time you are ready to start the 1000-mile engine break-in process.
- The first 50 miles are most critical for new rings and piston break-in. Engine damage is most likely to occur during this period. Keep heat down by not exceeding 2500 rpm. Avoid lugging the engine, riding in hot weather, or in stop and go

traffic. Vary the engine speed, but do not lug the engine. We recommend changing the oil at 50 miles.

**CAUTION**

**Lugging or running engine prematurely at sustained high rpm may result in damage to pistons and other engine components. S&S® voids its guarantee if engine is not broken in properly.**

- The next 500 miles should be spent running engine no faster than 3500 rpm or 60 mph. Avoid continuous steady speeds, and do not lug the engine. Vary engine rpm. We recommend changing the oil again at 500 miles.
- For the balance of the first 1000 miles the motor can be run in a normal but conservative manner. You can be more liberal with the rpm range and motorcycle can be operated at normal highway speeds. Avoid overheating or putting any hard strain on the engine: no drag racing, dyno runs, excessive speed, trailer towing or sidecar operation.
- After 1000 miles, verify carburetor jetting and adjustment. Change the engine oil. Motorcycle can now be operated normally.
- Have Fun!

**Additional Information:**

The following information is provided in case pistons must be replaced as in the event of an engine overhaul, or if the engine is to be set up for immediate severe duty such as drag racing or other competition application. See Piston Fit Specification chart below.

- For maximum piston and ring life, fit pistons using close fit dimensions. Close fit requires absolute adherence to new engine break-in as described in Step 6.
- For immediate drag strip use, fit pistons using loose fit dimensions. Break in rings and pistons with 50 easy miles if possible. Piston and ring life will be reduced with loose fit dimensions.
- Measure all pistons at widest point across thrust face, perpendicular to wristpin hole. Several measurements should be taken to locate widest point. Typically, this will be at bottom of piston skirt, and approximately 1/2" below level of wristpin hole.
- S&S® recommends #220-#280 grit stone for final honing of S&S bore cylinders.
- Follow procedure recommended in Harley-Davidson® service manual for boring and honing S&S cylinders, or follow instructions included with S&S Cylinder Torque Plate Kit. Torque plates must be used to simulate compressive stress in an assembled engine. Cylinders will distort if torque plates are not used.

**CAUTION**

**Failure to follow instructions and perform required clearancing, installation and/or break-in procedures may result in damage to pistons and/or other engine components not covered under warranty.**

PISTON FIT SPECIFICATIONS			
PART #	DESCRIPTION	CLOSE FIT	LOOSE FIT
106-5548 - STD 106-5549 - +.010" 106-5550 - +.020"	883 TO 1200 CONVERSION PISTON 1986-UP XL 3 1/2" BORE DISHED DOME	.0025" TO .0030"	.0035" TO .0045"
920-0070	1250CC PISTON 1986-UP XL 3 3/16" BORE FLAT DOME	.0025" TO .0030"	.0035" TO .0045"
920-0071	1250CC PISTON 1986-UP XL 3 3/16" BORE 5.5CC RAISED DOME	.0025" TO .0030"	.0035" TO .0045"
*NOTE: FIT WRISTPINS AT .0007" TO .0014".			