



TRIDENT-1400
1400mm dia. Navigation Buoy
Installation & Service Manual

Technical Specifications

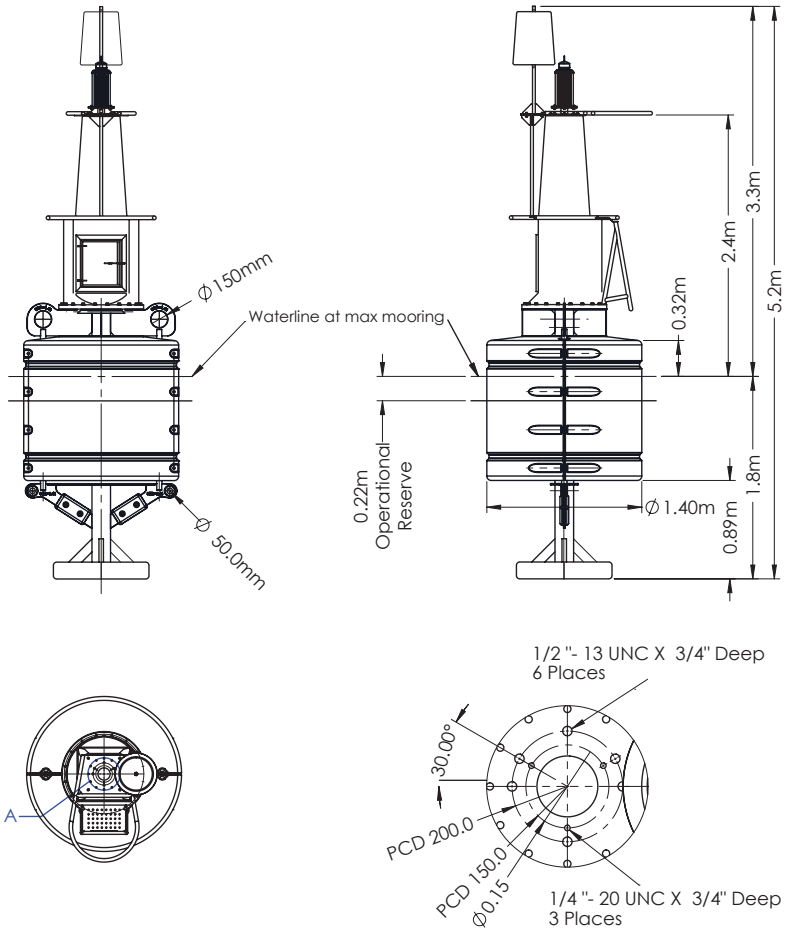

Figure 1.

Table of Contents

Introduction	Page 4
Sealite Buoy Division	Page 4
Why Choose Polyethylene Buoys?	Page 4
Mooring Requirements & Regulations	Page 4
TRIDENT-1400 Navigation Buoy	Page 5
Product Components.....	Page 6
Assembly Instructions	Page 7
Mooring Table	Page 10
Marine Buoy Maintenance	Page 11
Repair Prodedures	Page 12
Anode Replacement	Page 12
Disposal Plan	Page 13
Sealite Buoy Warranty	Page 15

Version No.	Description	Date	Approved
1.0	Manual Launch	January 2014	M. Henry

Introduction

Congratulations! By choosing to purchase a Sealite Buoy, you have become the owner of one of the most advanced rotationally-moulded polyethylene marine buoys in the world.

Sealite Pty Ltd has been manufacturing buoys for over 25 years, and particular care has been taken to ensure your buoy gives years of service.

As a commitment to producing the highest quality products for our customers, Sealite has been independently certified as complying with the requirements of ISO 9001:2008 quality management system.

By taking a few moments to browse through this booklet, you will become familiar with the versatility of your buoy, and be able to maximise its operating function.

Sealite Buoy Division

Sealite marine buoys are manufactured on-site from rotationally-moulded UV-stabilised polyethylene, and are designed to offer a low-maintenance, high visibility solution to marine navigation.

The Sealite buoy division provides turn-key production of navigation buoys. From tooling development, raw materials selection, and production, to final testing and inspection, Sealite guarantees superior quality and fast turn-around times.

Sealite's buoy products are available in a wide range of configurations and sizes, and can be economically shipped worldwide.

Why Choose Polyethylene Buoys?

- No painting
- Inhibits growth
- Increased interval between servicing
- Routine maintenance on location
- Easily repaired in the unlikely event of damage
- Lightweight for ease of deployment and maintenance
- Environmentally friendly – no use of toxic antifouling paint

Mooring Requirements & Regulations

Please contact your local authority for any specific requirements regarding the deployment of buoys. IALA also has guidelines and recommendations that should be followed.

All information given in this manual is advisory only. Please consult with your local authority before deploying your buoy products.

Local conditions that need to be considered include:-

- Water depth
- Maximum currents
- Maximum wind speeds
- Sinker size and weight

TRIDENT-1400 Navigation Buoy

The TRIDENT-1400 is a rotationally-moulded navigation buoy with a float diameter of 1.4 meters and lantern focal height of of at least 2.7 meters.

The float section of the TRIDENT-1400 is built from two (2) rotationally-moulded sections, which fasten together to form an incredibly robust 1.4 meter wide float section. Each hull section is moulded from UV-stabilized, virgin polyethylene, and has a 13mm wall thickness. Each section is filled with closed-cell polyurethane, which prevents the ingress of moisture in the unlikely event of damage.

SPECIFICATIONS * * TRIDENT-1400

General Characteristics

Available Colours
Focal Plane Height (mm/inches)
Total Float Volume (litrs/US gallon)
Nominal Freeboard (mm/inches)
Nominal Draft (mm/inches)
Reserve Buoyancy (kgs/lbs)
Draft, Maximum (mm/inches)
Freeboard, Minimum (mm/inches)
Safe Working Load, lift (kgs/lbs)
Safe Mooring Load, (kgs/lbs)
Submergence (kg/cm, lb/inches)
Visual Area (m²/ft²)
Water Area (m²/ft²)

Red, Green, White, Yellow as per IALA Recommendations
2700 / 106¼ (nominal)
1888 / 498
540 / 21¼
1580 / 62¼
570 / 1256
1800 / 70⁷/₈
320 / 12⁵/₈
4000 / 8818 (per eye)
2400 / 5290 (per mooring point)
15 / 84
2.4 / 25.8 (nominal)
1.3 / 14.0

Mooring Details

Minimum recommended anchor size (kg/lbs)
Recommended mooring mass (kg/lbs)

Wet weight: 1300 / 2866

Minimum: 250 / 551
Maximum: 600 / 1323

Physical Characteristics

Material

Rotationally-moulded UV-stabilized virgin polyethylene float section, tower assembly and top marks.
316-grade stainless steel fixtures.

Wall Thickness (mm/inches)
Ballast (kg/lbs)
Overall Height (mm/inches)
Width (mm/inches)
Mass with Ballast(kg/lbs)
Radar Reflector
Product Life Expectancy

13 / ½
490 / 1080 (external steel)
5200 / 204¾
1400 / 55¹/₈
907 / 2000 (depending on payload)
Echomax EM230
>20 years

Certifications

Quality Assurance

ISO9001:2008

Intellectual Property

Trademarks

SEALITE® is a registered trademark of Sealite Pty Ltd

Warranty *

5 years

Lantern Options

Options Available

Sealite SL-C310, SL-C410, SL-C415, SL-C420, SL-125 Series or SL-155 Series
• Mould-in graphics
• Monitoring Systems (AIS, GSM)



* Specifications subject to change or variation without notice
• Subject to standard terms and conditions

TRIDENT-1400 Product Components

Item No.	Description	Qty.	ED No.
1	Top Mark Small Can	1	000101-001
1	Top Mark Small Cone	1	000101-002
1	Top Mark Small Sphere	1	000101-103
4	SLB1400D Top Mark Post	1	000101-104
	M8 X 40 U Bolt, Nuts and Washers	1	000101-117
	M10 X 100 Bolts, Nuts, Washers and Spring Washers	2	000101-118
7	SLB1400D Tower	1	000101-107
	M10 X 16 Bolts, Washers and Spring Washers	5	000101-119
	M10 X 100 Bolts, Nuts, Washers and Spring Washers	16	000101-120
	M10 X 70 Bolts, Nuts, Washers and Spring Washers	16	000101-121
9	SLB1400D Ladder	1	000101-109
10	SLB1400D Float	2	000101-110
	Float Bush	16	000101-111
15	SLB1400D Post Post Assembly	1	000101-112
	M12 X 90 Bolts, Nuts, Washers and Spring Washers	8	000101-122
11	SLB1400D Mooring Bush	4	000101-116
21	SLB1400D Guard Rail Tube Plate	1	000101-106

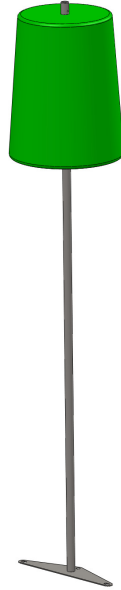

Figure 2. Top Mark



Assembly Instructions

Check Components

Unpack all components from container. Inspect all components for damage. Please alert Sealite if any component is missing or damaged.

Assembly Instructions

Step 1

Position one of the float halves on its curved face on a firm flat surface. Chock each side of the float to prevent it from rolling.

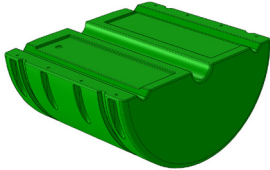

Figure 3.

Step 2

Position the mooring post in the three large grooves along the length of the float. The flat end of the float half should be at the base end of the mooring post. (The shallow tapered end will rest under the mooring post deck plate).

Secure the float halves together using 8xM12 Bolts, nuts and washers. With each connection place a flat washer on the bolt before sliding it through the hole in the float section, then fit a second flat washer and a spring washer on to the bolt before securing with a nut.

Please coat each bolt in Anti-seize or molybdenum disulphide grease before fitting nuts.

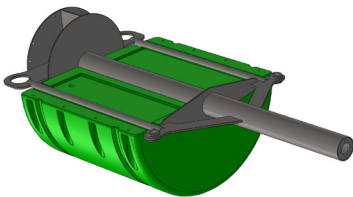

Figure 4.

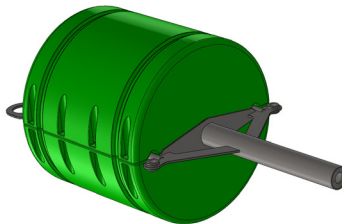

Figure 5.

Step 3

Lift and secure the tower assembly onto the mooring post. The tower should be positioned with the ladder at the middle point of the two lifting eyes.

Secure the tower to the deck plate in 16 places using M10x70mm long bolts, flat and spring washers and nuts.

Please coat each bolt in Anti-seize or molybdenum disulphide grease before fitting nuts.

Step 4

Fit the top mark assembly to the tower. Fix to the tower shelf in 3 places using M10x16mm long bolts and spring washers. Fix the post to the guard rail assembly using one 8mm x 40 U-Bolt, plain washers, spring washers and nuts.

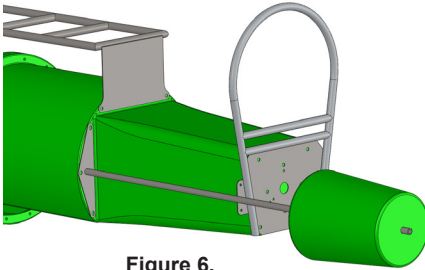

Figure 6.

Step 5

Lift the buoy only using the lifting eyes on the mooring post deck.



- **DO NOT USE THE GUARD RAIL AS A LIFTING POINT**
- **DO NOT USE THE TOP MARK AS A LIFTING POINT.**
- **DO NOT USE THE LADDER AS A LIFTING POINT**
- **DO NOT USE SOLAR PANELS AS A LIFTING POINT.**
- **ONLY USE A SLING AROUND THE BODY OF THE TOWER TO MOVE INTO POSITION**

Mooring Table

Water Depth Range (m)	Target Water Depth (m)	Total Weight of Mooring Accessories including Chain (kg)	Counterweight (kg)	Sinker Wet Weight (kg)
< 10	5 (min)	800	483.2	1300
10 – 20	10	818	483.2	1300
20 – 30	20	818	483.2	1300
30 – 40	30	840	483.2	1300
> 40	40	785	483.2	1300
	50 (max)	960	483.2	1300



Marine Buoy Maintenance

Sealite Marine Buoys are designed to require very little maintenance. We recommend the buoy be inspected annually. Inspection may need to increase depending on the local conditions and the position of the buoy.

IALA Recommendation AISM E-107 suggests moorings are inspected annually.

Marine Buoy – Annual Maintenance

- Visual inspection of the buoy's surface, seams, fittings, lifting assembly and other auxiliary components
- Inspect the top mark for any damage. Repair any broken or damaged section.
- Clean buoy of animal debris, pressure washing may be applied up to 2 MPa (3 ksi) to remove fouling
- The removal of ice accumulation may be facilitated with the use of a non-metallic mallet (e.g. wood or rubber)
- The securing of loose fasteners due to expanding and contracting of mating surfaces

Mooring – Annual Maintenance

- Check and clear the tail and ride chains from shells and algae.
- Check for wear on any shackle axis and check the tapered pins. Any worn shackles must be replaced.
- Check the free movement of each swivel around its head. If any swivel head sticks it must be replaced.
- Check every link of the thrash length of the chain. Check the diameter of the nips and sides and also inspect the welds on every link.
- If depth allows, a worn riding chain may be reversed.
- Change a chain when any link shows excessive wear.
- Chain must be replaced if any link wears to less than 3/5 of the original diameter.\

Mooring – Biannual Maintenance

- Inspect the ground chain and sinker.

Lanterns – Maintenance

- Please refer to the Installation Manual for the specific Marine Lantern fitted to the Buoy.



Repair Procedures

Minor repairs to the polyethylene components of the buoy many be undertaken during its service life.

To undertake this a heat gun and polyethylene welding rods are required.

- Remove the buoy from service
- If floatation section is breached, drain any water from the buoy and ensure internal buoyancy foam is completely dry.
- Clean the area of the buoy that needs to be repaired using soap and water. The surface of the buoy needs to be free of any oil, grime, marine growth, paint or anti-fouling.
- If a crack has breached the buoy material, drill a small hole at each end of the crack with a small drill bit. This will prevent the crack from extending any further in either direction.
- Preheat the repair area with a heat gun or propane torch. Heat a slightly larger area than you are repairing to make sure that you have an even heat distribution over the entire breach.
- Add the filler material. Using a small strip of polyethylene filler material, place it over the crack and continue to heat the repair area with the heat gun. Slowly move the material so that it fills the crack completely. Smooth out the molten plastic so that it fills the entire area. Trim off any excess with a utility knife.

Anode Replacement

The buoy is fitted with four sacrificial aluminium alloy anodes which will provide years of service, however they will need to be inspected and replaced at service intervals. If the anodes are allowed to be completely consumed there will be no corrosion protection in place. Replacement anodes may be sourced from your Sealite distributor.

- The anodes are fitted as pairs on each support web, with each pair secured by two bolt assemblies made up of an M12x70 bolt, 2 flat washers, spring washer and M12 nut.
- The anodes are NOT designed to be welded to the buoy structure.
- All four anodes must be replaced at the same time, do not use mixed new and old anodes.
- It is assumed the buoy has been removed from the water and has been thoroughly cleaned.

The following procedure describes the replacement of one anode pair:-

- Loosen and remove the two nuts, extract the two bolt assemblies
- Remove the two used anodes and dispose
- Thoroughly clean the mating surface on the buoy web to ensure a clean and flat surface. Do not use grinders or heavy files to clean the surface. Correct operation of the anode requires an electrically secure interface from the back plate of the anode to the web surface.
- Ensure the new anodes exhibit a clean and flat mating surface.
- Position the two new anodes in place on each side of the web. The anode's metal plate surface must be flush against the web.
- Secure the anodes with the two bolt assemblies in the correct order (bolt - flat washer - anode – web – anode - flat washer - spring washer - nut)
- Tighten the nuts up to the recommended torque of 61.2 Nm (or 45.1 ft.lb)



Disposal Plan Procedures

Components of the Trident-1400 buoy are recyclable.

Prior to delivery to your local recycling depot, the buoy components should be cleaned free from marine growth and other foreign debris. Contamination with other materials can often be an issue when recycling.

Steelwork (including fasteners)

The steelwork used in the Trident-1400 buoy is completely recyclable. Contact your local metal recycling depot for further instructions.

Each year millions of tons of steel is recycled by steelmaking furnaces throughout North America. This use of steel scrap to make new steel conserves energy, reduces emissions and conserves natural resources.

The presence of zinc coating on steel does not restrict steel's recyclability and all types of zinc-coated products are recyclable.

Polyethylene

Contact your local recycling depot for polyethylene. Sealite buoys are made from low-density polyethylene. The buoy components must be clean and in a recyclable condition, and supplied to the recycling depot in accordance with their specific instructions.

For the purpose of the Solicitation No. FP999-130001/A Sealite shall cover the fair cost of recycling buoy parts when delivered to recycling depots in accordance with their specific requirements for product recycling.

Alternatively, Sealite may accept delivery of the clean buoy parts to Sealite USA LLC (NH) at the end of its service life for disposal by Sealite on behalf of the Canadian Coast Guard.

Buoy components delivered must be cleaned from any debris or marine growth.

Recyclable polyethylene parts are marked;





Notes

Sealite Buoy Warranty V2.2

Activating the Warranty

Upon purchase, the Sealite Pty Ltd warranty must be activated for recognition of future claims. To do this you need to register online. Please complete the Online Registration Form at:

www.sealite.com

Sealite Pty Ltd will repair or replace your buoy product in the event of failure for a period of up to twelve months (small buoy products less than 1500mm diameter) & a period of up to five years (large buoy products 1500mm diameter & larger) from the date of purchase.

The unit must be returned to Sealite freight prepaid.

Warranty Terms

1. Sealite Pty Ltd warrants that any rotationally-moulded buoy products ("Buoy Products") will be free from defective materials and workmanship under normal and intended use, subject to the conditions hereinafter set forth, for a period of twelve (12) months for small buoy products up to under 1500mm diameter, and for a period of five (5) years for large buoy products including and over 1500mm in diameter from the date of purchase by the original purchaser.
2. Sealite Pty Ltd will repair or replace, at Sealite's sole discretion, any Buoy Products found to be defective in material and workmanship in the relevant warranty period so long as the Warranty Conditions (set out below) are satisfied.

Warranty Conditions

This Warranty is subject to the following conditions and limitations;

1. The warranty is applicable to buoys manufactured from 1/1/2009.
2. The warranty is void and inapplicable if:
 - a. the product has been used or handled other than in accordance with the instructions in the owner's manual and any other information or instructions provided to the customer by Sealite;
 - b. the product has been deliberately abused, or misused, damaged by accident or neglect or in being transported; or
 - c. the defect is due to the product being repaired or tampered with by anyone other than Sealite or authorised Sealite repair personnel.
3. The customer must give Sealite Pty Ltd notice of any defect with the product within 30 days of the customer becoming aware of the defect.
4. No modifications to the original specifications determined by Sealite shall be made without written approval of Sealite Pty Ltd.
5. The product must be packed and returned to Sealite Pty Ltd by the customer at his or her sole expense. Sealite Pty Ltd will pay return freight of its choice. A returned product must be accompanied by a written description of the defect and a photocopy of the original purchase receipt. This receipt must clearly list model and serial number, the date of purchase, the name and address of the purchaser and authorised dealer and the price paid by the purchaser. On receipt of the product, Sealite Pty Ltd will assess the product and advise the customer as to whether the claimed defect is covered by this warranty.
6. Sealite Pty Ltd reserves the right to modify the design of any product without obligation to purchasers of previously manufactured products and to change the prices or specifications of any product without notice or obligation to any person.

Limitation of Liability

To the extent permitted by acts and regulations applicable in the country of manufacture, the liability of Sealite Pty Ltd under this Warranty will be, at the option of Sealite Pty Ltd, limited to either the replacement or repair of any defective product covered by this Warranty. Sealite will not be liable to Buyer for consequential damages resulting from any defect or deficiencies.

Limited to Original Purchaser

This Warranty is for the sole benefit of the original purchaser of the covered product and shall not extend to any subsequent purchaser of the product.

Miscellaneous

Apart from the specific warranties provided under this warranty, all other express or implied warranties relating to the above product is hereby excluded to the fullest extent allowable under law. The warranty does not extend to any lost profits, loss of good will or any indirect, incidental or consequential costs or damages or losses incurred by the purchaser as a result of any defect with the covered product.

Warrantor

Sealite Pty Ltd has authorised distribution in many countries of the world. In each country, the authorised importing distributor has accepted the responsibility for warranty of products sold by distributor. Warranty service should normally be obtained from the importing distributor from whom you purchased your product. In the event of service required beyond the capability of the importer, Sealite Pty Ltd will fulfil the conditions of the warranty. Such product must be returned at the owner's expense to the Sealite Pty Ltd factory, together with a photocopy of the bill of sale for that product, a detailed description of the problem, and any information necessary for return shipment.

Information in this manual is subject to change without notice and does not represent a commitment on the part of the vendor.
Sealite products are subject to certain Australian and worldwide patent applications.

Other Sealite Products Available



**Marine Lanterns
(1-19NM)**



**Monitoring
& Control Systems**



Bridge & Barge Lights



**Marine Buoys
(up to 3mt in diameter)**



Area Lighting

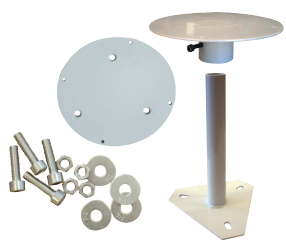

**Mooring Systems
& Accessories**



Head Office
Sealite Pty Ltd
11 Industrial Drive
Somerville, Vic 3912
Australia
Tel: +61 3 5977 6128
Fax: +61 3 5977 6124
Email: info@sealite.com
Internet: www.sealite.com

