

Owners Manual

Öhlins shock absorber ST 44



Including:

Safety

Tuning the
suspension

Design

Function

Settings

Setting your
vehicle

Inspection and
maintenance



Safety signals

Important information concerning safety is distinguished in this manual by the following notations:



*The Safety alert symbol means:
Caution! Your safety is involved.*

WARNING!

*Failure to follow warning instructions could result in **severe or fatal injury** to anyone working with, inspecting or using the suspension, or to bystanders.*

CAUTION!

Caution indicates that special precautions must be taken to avoid damage to the suspension.

NOTE!

This indicates information that is of importance with regard to procedures.

Introduction

All of Öhlins advanced suspension products are adapted to the brand and model. This means that length, travel springaction and damping characteristics, are tested individually just for the vehicle that you have decided to fit with Öhlins suspension.

Before installation

Öhlins Racing AB can not be held responsible for any damage whatsoever to suspension or vehicle, or injury to persons, if the instructions for fitting and maintenance are not followed exactly.

Similarly, the warranty will become null and void if the instructions are not adhered to.

Contents

Safety	2
Tuning the suspension	3
Design	3
Function	4
Settings	4
Setting your vehicle	6
Inspection and maintenance	7

WARNING!

1. Installing a suspension, that is not approved by the vehicle manufacturer, may affect the stability of your vehicle. Öhlins Racing AB cannot be held responsible for any personal injury or damage whatsoever that may occur after fitting the suspension. Contact an Öhlins dealer or other qualified person for advice.

2. Please study and make certain that you fully understand all the mounting instructions and the owners manuals before handling this suspension kit. If you have any questions regarding proper installation procedures, contact an Öhlins dealer or other qualified person.

3. The vehicle service manual must be referred to when installing the Öhlins suspension.

NOTE

Öhlins products are subject to continual improvement and development. Consequently, although these instructions include the most up-to-date information available at the time of printing, there may be minor differences between your suspension and this manual. Please consult your Öhlins dealer if you have any questions with regard to the contents of the manual.

© Öhlins Racing AB.

All rights reserved.

Any reprinting or unauthorized use without the written permission of Öhlins Racing AB is prohibited.

Printed in Sweden.

Design principles

1. External reservoir with hose connection
2. External piggyback reservoir

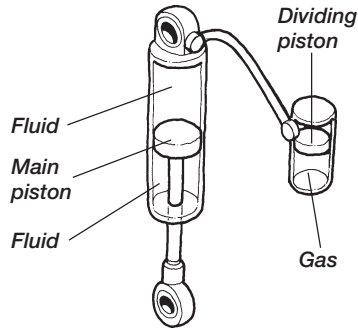

1. External gas reservoir hose connected

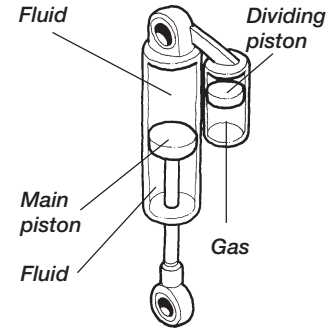

2. External gas reservoir piggyback

Tuning the suspension

Road holding qualities

All vehicles are designed with a suspension geometry that includes wheel movements and angles. The changing of components can affect this and it is therefore essential that both the rear and the front ends match each other. Changing to Öhlins suspension gives optimum performance only when both the front and the rear suspension interact properly.

Everything must harmonize

Incorrect spring action can affect the road holding abilities in a negative way. This in turn can give a tendency for oversteering or understeering, which could seriously affect the road holding characteristics of the vehicle. It's important that the springs are checked for correct length and stiffness when Öhlins shock absorbers are mounted.

Design

The Öhlins suspensions type ST 44 is of the De Carbon type.

The fluid is put under gas pressure and the gas and the fluid are kept apart by a separating piston. The gas and the separating piston are fitted in separate fluid reservoir, connected by hose or fixed direct on top of the shock absorber (piggyback).

Pressurization of the fluid is made with nitrogen. The pressurization prevents cavitation of the fluid and the shock absorbing action is therefore more even. The external fluid chambers also contribute to better cooling of the fluid, giving longer service life for both the fluid and components.

Öhlins shock absorbers have integrated temperature compensation. As the temperature increases and the fluid flows more easily the flow is controlled accordingly. The shock absorbing effect is therefore independent of the temperature.

Öhlins shock absorbers provide the possibility for adjustment, making them adaptable to most vehicles, drivers and ranges of use. ST 44 models permit individual adjustment of compression damping and rebound damping, and also certain adjustment of the length of the shock absorber. The ST 44 can be equipped with high- and low speed compression damping.

Fig 1. Flow through needle valve

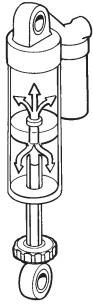

Fig 2. Flow regulated by shims

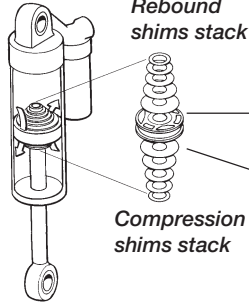

Fig 2. Piston with aperture

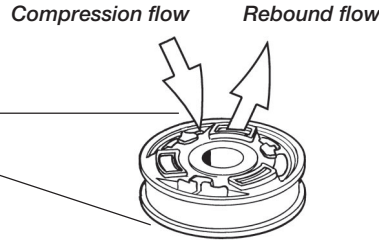
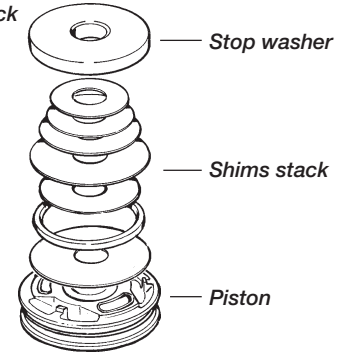

Fig 3. Shim stack



Function

The function, in principle, is that fluid is forced through needle valves at a low rate of flow (Fig.1) and through a number of apertures in the piston at a high rate of flow (Fig.2). The flow through these apertures is regulated by shims (thin steel washers) that at high pressure are deflected to open for the fluid. On some models the needle valves can be set individually.

By altering the size of the shims-stack (ie, number, thickness, diameter) (Fig. 3) the characteristics of the damping action can be varied (this shall only be done by Öhlins authorized service workshops).

Compression damping

When movement of the vehicle causes compression in the shock absorber, the fluid flows through the needle valve (combined compression and return valve) in the piston rod. If velocity of the piston is high, ie, in the case of rapid compression, this will not be sufficient and consequently the shims underneath the piston will open to allow a

greater rate of flow. The fluid that is displaced by the volume of the piston rod is forced into the external fluid chamber via a separate compression valve. Even this valve is fitted with shims that open at high piston velocity. The separating piston is displaced, thus increasing the gas pressure.

Rebound damping

When the spring presses the shock absorber out again, the fluid flows back through the needle valve in the piston rod. The fluid flowing into the chamber is forced by the pressure of the gas back into the shock absorber via a separate nonreturn valve (illustration). If velocity of the piston is high, the shims on top of the piston will also open to allow the fluid to flow through.

Settings

Basic settings

Always ensure that the basic setting made by the Öhlins dealer is correct.

Setting the spring preload

Preload on the spring/springs is very important, because it affects the height of the vehicle and the wheel angles. Consequently, road holding characteristics can be changed, even negatively.

Adjustment is made with the ring on the shock absorber.

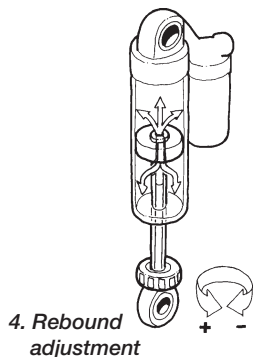

4. Rebound adjustment

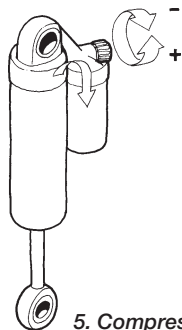

5. Compression adjustment

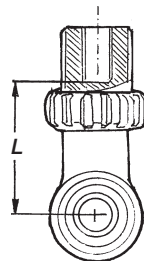

End-eye complete

Part no	Length (L)
05909-01	36
05909-02	58
05909-03	48
05909-04	68

Setting the damping

The adjusting possibilities of Öhlins shock absorbers facilitate fine setting. You can optimize adjustments to suit your own vehicles weight and equipment, your individual way of driving and the condition of the track. To be able to improve the road holding qualities it is of the utmost importance that you fully understand the functioning of the shock absorbers. Then you can learn by trial and error how they affect the vehicle.

NOTE!

Ensure that the springs are properly preloaded before attempting to make any adjustments. A simple rule is that increased preload of the spring should be followed by an increase of rebound damping by two steps.

Depending on the model there are adjustments for rebound damping and compression damping. Damping is set with the knobs, they have a normal right-hand thread. By turning clockwise

they increase the damping action and anticlockwise they reduce it. The knobs have definite positions with a noticeable “click”, so it is easy to count to the right setting.

Rebound damping action affects the characteristics of the vehicle most. The setting knob is at the bottom on the piston rod (Fig.4). It can be adjusted in about 40 steps. The compression damping knob is on the top of the cylinder (Fig.5). This can be adjusted in about 25 steps.

NOTE!

When making new adjustments it is easiest to go back to zero, and then count forward to the new setting. The adjusting knobs should not be turned in too hard. Avoid tools when attempting to adjust the shock absorber. The adjustment **should** be made when the shock absorber is **cold**.

Set-up data

	Model	
Length	STN9B01/11	239.5 mm
	STN9B02/12	299.5 mm
	STN9B03/13	339.5 mm
	STN9B04/14	399.5 mm
Stroke	STN9B01/11	70
	STN9B02/12	100
	STN9B03/13	120
	STN9B04/14	150

Rebound adj.	48 clicks
Compression adj.	25 clicks

NOTE!

The adjustment ranges can vary a few clicks depending on what shim stack the shock absorber is equipped with.

When delivered from Öhlins the settings are:	
Rebound adj.	10 clicks
Compression adj.	10 clicks

6. Rebound adjustment

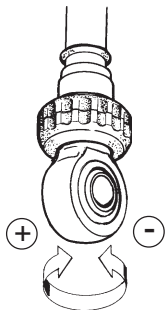

- + Added damping force**
- Reduced damping force**

7. Adjustment of compression damping

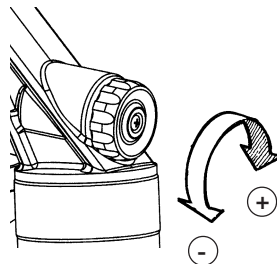

Piggyback reservoir

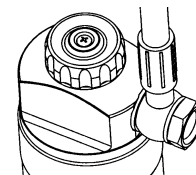

Hose reservoir

Setting your vehicle

By utilizing the adjustment possibilities you can test by trial and error, and learn how they affect your vehicle.

Always begin by test driving with all adjustments at their basic setting. Choose a short run of varying character, ie, long and sharp bends, hard and soft bumps. Keep to the same run and adjust only one setting at a time.

NOTE!

Always begin with the basic settings recommended by the Öhlin dealer. Always make notes, adjust in small steps and make only one adjustment at a time. Adjustments should be made with two steps (clicks) at a time. Adjustments should not be more than four steps from the basic setting.

Start with the rebound damping

If the vehicle feels unstable, loose and rather bouncy then the rebound damping should be increased (Fig.6). Begin by turning the adjusting knob 4 steps (clicks) clockwise. Test run again and adjust two steps back if it felt too hard and bumpy.

If the vehicle is hard and bumpy, especially over a series of bumps, then the rebound damping should be reduced. Turn counterclockwise 4 steps, test run and make any necessary correction to 2 steps.

Compression damping

If the vehicle feels soft, has low riding position and a tendency to bottom easily in long dips then the compression damping should be increased (Fig.7). Screw clockwise 4 steps and test run again. If this was too much then turn back two steps (anticlockwise).

If the vehicle feels harsh and has hard resilience, eg, over changes in the road paving, then the

compression damping must be reduced. Screw anticlockwise 4 steps. Test run and make any necessary correction to two steps.

When you have sufficient feel of the vehicle then you can make further fine adjustments. It is feeling and experience that counts.

NOTE!

If no "click" is felt, the shock absorber must be inspected by an authorized service workshop. It could be due to incorrect or lack of gas pressure.

When you feel that you have achieved an improvement, go back to where you started and check once more. Be observant of other relevant factors such as tyres, temperature, etc. Test run to make sure whether further fine adjustment should be made.

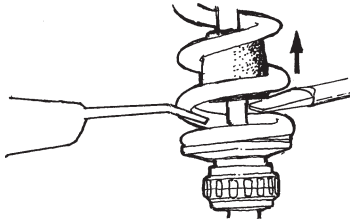

Lift the bump rubber and clean the area below.

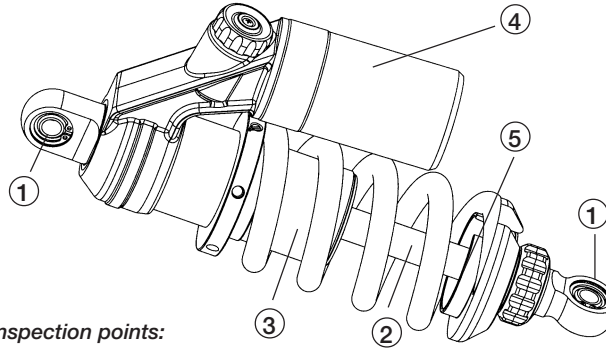

Inspection points:

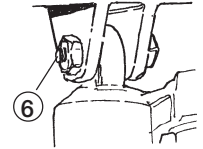

Inspection and maintenance

Keep the shock absorbers clean and always spray them with oil (QS 14, WR40 or CRC 5-56) after washing the vehicle.

Inspection points:

1. Check ball joints for possible excessive play.
 2. Check the piston shaft for leakage and damage.
 3. Check the shock absorber body and for external damages.
 4. Check the external reservoir for damages that can restrict the floating piston from moving freely.
 5. Excessive wear of rubber components
 6. Fastening to the vehicle
- Check the hose equipped models for leaks in hose and inlet plugs.

Preventive maintenance and regular inspection reduces the risk of functional disturbance. If there is any need for additional service, please get in touch with an authorized Öhlins service workshop. There they have the necessary tools and know-how for whatever you need.

⚠ WARNING!

Never alter the gas pressure. Special-purpose charging equipment and access to nitrogen is required. The gas pressure should normally never be altered.

NOTE!

Make certain that your shock absorbers are always filled with Öhlins High Performance Shock Absorber Oil.

Remember!

Regular maintenance and inspection contribute to the prevention of functional disturbances.

More info

www.ohlins.com

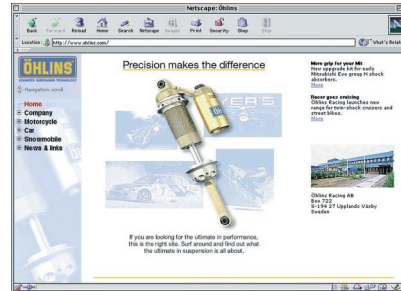

The ultimate suspension site.
Find out everything about your suspension.
Download mounting instructions, manuals and brochures.
And a lot more.



Öhlins Racing AB, Box 722, S-194 27 Upplands Väsby, Sweden
Phone +46 8 590 025 00, Fax +46 8 590 025 80

Your Öhlins dealer: