

SERVICE-MANUAL

Arco-3000

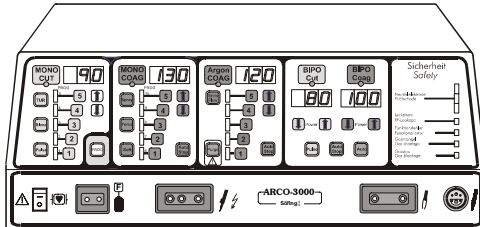

Arco-2000

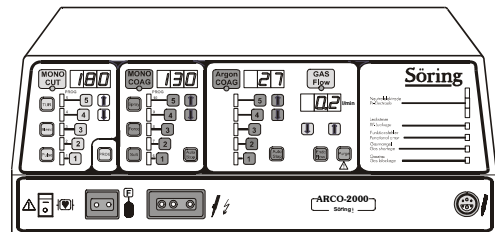

Arco-1000

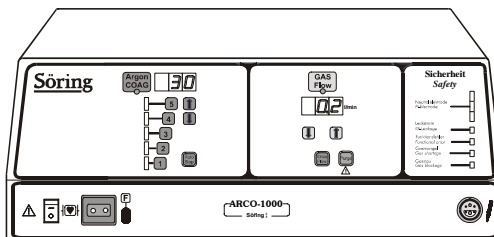

MBC-601

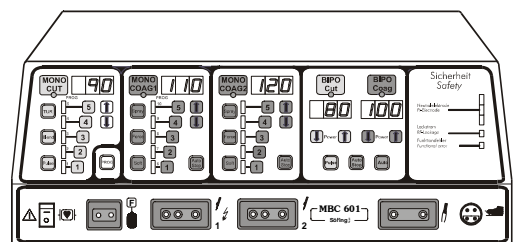

MBC-600

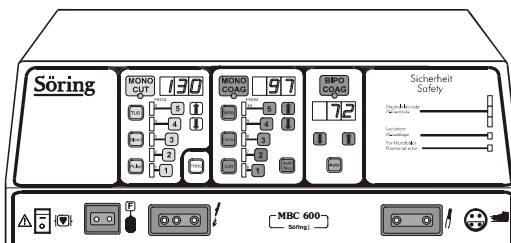

Söring
Made in Germany

Söring GmbH
Medizintechnik
Justus von Liebig Ring 2
25451 Quickborn

Tel: (+) 49 (0)4106-6100-0
Fax: (+) 49 (0)4106-6100-10
E-mail: info@soering.com

SM-3000
03-003 R8a

Contents

	Page
1. Overview.....	10
1.1 General description of the Arco-units, MBC-units	10
1.2 Co-operation of units.....	12
Arrangement of modules of the Arco-3000	13
Arrangement of modules of the Arco-2000	14
Arrangement of modules of the Arco-1000	15
Arrangement of modules of the Arco-1000 Table-Top.....	16
Arrangement of modules of the MBC 601.....	17
Arrangement of modules of the MBC 600.....	18
Block diagram of units.....	19
Block diagram primary current supply of the units	20
Description of units.....	21
2. Primary power supply.....	21
2.1 Description of power supply board	21
Block diagram mains board 1/2	23
Block diagram mains 2/2	24
3. Description of microcontroller unit, board CPU	25
3.1. General description	25
3.2. Connection to other units	25
3.2.1. Connection to frontpanel.....	25
3.2.2. Connection to handpiece recognition unit.....	25
3.2.3. Connection to high-power supply	25
3.2.4. Connection to Cut-module ⁴	25
3.2.5. Connection to Coag-module.....	25
3.2.6. Connection to relay board	25
3.2.7. Connection to the mains relay board.....	26
Block diagram CPU board.....	27
4. Description of front panel.....	28

¹ not valid for A-3000/ -2000
² not valid for Arco-2000

³ not valid for MBC600
⁴ not valid for Arco-1000

4.1. General description	28
4.2. Connection to other units	28
4.2.1. Connection to CPU	28
4.2.2. Connection to low-voltage supply.....	28
Block diagram Frontpanel.....	29
5. Description of high-power supply	30
5.1. General description	30
5.2. High-power supply, design and function	30
5.3. Technical data	31
Block diagram High power supply	32
6. Description of Cut-module⁴	33
6.1. General description	33
6.2. Final stage and output filter	33
6.3. Oscillator and driver	34
6.4. Switching stage	34
6.5. Short circuit switch-off	34
6.6. Current limiting, current control	34
6.7. Power limiting	35
6.8. Arc regulation.....	35
6.9 Pulse generation and control logic.....	35
6.10 Signal shapes	36
<i>This signal-shape is used for the function Cutting with Blend</i>	<i>36</i>
Block diagram Cut module.....	37
7. Description of RF-output module.....	38
7.1. General description	38
7.2. Description of board HFO_A	38
7.2.1. Design/function of board HFO_A.....	38
7.3. Description of board HFO_B	39
7.3.1. Design/function of board HFO_B.....	39
Block diagram RF-Output Board /A	40

¹ not valid for A-3000/ -2000
² not valid for Arco-2000

³ not valid for MBC600
⁴ not valid for Arco-1000

Block diagram RF-Output board /B	41
8. Description of coagulator module	42
8.1. General description	42
8.2. Function of coagulator module.....	42
8.3. Technical data coagulator module.....	43
8.4 Signal shapes	43
Block diagram Coagulation module (fig 8.1)	45
9. Description of handpiece recognition	46
9.1. Properties	46
9.2. Function	46
Block diagram Handpiece recognition board	47
10. Description of interface board	48
Block diagram Interfaceboard	49
11. Description of gas-system¹	50
11.1. External gas-system	50
11.2. Internal gas system (gas control unit and gas control board).....	50
11.2.1. General description	50
11.2.2. Principle of operation	50
11.2.3. Design of gas control unit.....	50
11.2.4. Technical data	50
Block diagram Gasunit (fig. 11.1)	51
11.3. Description of gas control board	52
11.3.1. General description of gas control board.....	52
11.3.2. Description of gas control board	52
Block diagram gas control board (fig. 11.2)	53
12. Service- and adjustment procedures	54
12.1. Description of LEDs and adjustment potentiometers	54
Arrangement of LEDs and potentiometers I	56
Arrangement of LEDs and potentiometers II	57
12.2. Error indication at system start	58

¹ not valid for A-3000/ -2000
² not valid for Arco-2000

³ not valid for MBC600
⁴ not valid for Arco-1000

12.3. Configuration of important bus cables and connectors	58
12.4. Service mode	60
12.4.1. Preparation of service mode.....	60
12.4.2 Switching to service mode.....	60
12.4.3. Selecting service functions.....	61
12.4.4. Description of service functions.....	62
12.4.5. Performing service adjustments.....	62
12.4.5.1. Checking and adjusting basic settings of gas system (Service function 0).....	62
12.4.5.2. RF-output signal delay Argon coagulation (from SM 4.3 gas flow adjustment) (Service function 4).....	62
12.4.5.3. Start delay bipolar / Resonance frequency bipolar recognition.....	62
12.4.5.4. Adjustment of gas flow (Service functions 3,7,8,9,10).....	63
12.4.5.5. Adjustment of patient electrode recognition (Service function 5).....	64
12.4.5.6. Auto stop times (Service function 2).....	64
12.4.5.7. Service adjustments of Cut module (Service functions 11 and 12).....	64
12.4.5.8. Calibration of cut module power (Service function 13).....	65
12.4.5.9. Loudness adjustment (Service function 1).....	65
12.4.5.10. Check of power measurement (Service function 14).....	65
12.4.5.11. Indication power supply voltage and current (Service function 15).....	65
12.5. Service adjustments of the modules	66
12.5.1. Adjustment of high power supply.....	66
12.5.2. Adjustment of coagulator module.....	66
12.5.3. Adjustment of cut-module.....	67
12.5.4 Adjustment of RF-Out B2 (SMD) [from SW 3.10].....	68
13. Technical data	69
Power diagram Cutting⁴	75
Power diagram Blend⁴	75
Power diagram TUR⁴	76
Power diagram Pulse⁴	76
Power diagram TUR-Pulse⁴	77
Power diagram Spray-Coagulation	78
Power diagram Force-Coagulation -Effect 1⁴	78
Power diagram Force-Coagulation -Effect Hi⁴	79
Power diagram Force-Coagulation -Effect 5⁴	79
Power diagram Force-Coagulation -Effect 9⁴	80
Power diagram Soft-Coagulation⁴	80
Power diagram Argon 1,6-Coagulation⁴	81

¹ not valid for A-3000/ -2000
² not valid for Arco-2000

³ not valid for MBC600
⁴ not valid for Arco-1000

Power diagram Argon 2,4-Coagulation⁴	81
Power diagram Argon open-Coagulation⁴	82
Power diagram Bipolar Cutting^{2,3,4}	83
Power diagram Bipolar Coagulation^{2,4}	83
13.1. Visual and acoustical signals	84
14. Technical checks regarding safety (TSC)	85
14.1. Intervals	85
14.2. Extent	85
14.3. Description of special checks	85
14.3.1 Check of controls and indicators	85
14.3.2 Check of handpieces and foot switches	86
14.3.3 Check of RF-generators and safety-devices	86
14.3.4. Power measurement.....	86
14.3.7. Measurement of gas-flow ¹	87
14.3.9. Check of handpiece allocation-relay.....	87
Annex	88
Microprocessor-Modul (CPU)	Fehler! Textmarke nicht definiert.
layout plan	Fehler! Textmarke nicht definiert.
circuit plans 1/10	Fehler! Textmarke nicht definiert.
circuit plans 2/10	Fehler! Textmarke nicht definiert.
circuit plans 3/10	Fehler! Textmarke nicht definiert.
circuit plans 4/10	Fehler! Textmarke nicht definiert.
circuit plans 5/10	Fehler! Textmarke nicht definiert.
circuit plans 6/10	Fehler! Textmarke nicht definiert.
circuit plans 7/10	Fehler! Textmarke nicht definiert.
circuit plans 8/10	Fehler! Textmarke nicht definiert.
circuit plans 9/10	Fehler! Textmarke nicht definiert.
circuit plans 10/10	Fehler! Textmarke nicht definiert.
Cut-Modul	Fehler! Textmarke nicht definiert.
layout plan	Fehler! Textmarke nicht definiert.

¹ not valid for A-3000/ -2000
² not valid for Arco-2000

³ not valid for MBC600
⁴ not valid for Arco-1000

circuit plans 1/4	Fehler! Textmarke nicht definiert.
circuit plans 2/4	Fehler! Textmarke nicht definiert.
circuit plan 3/4	Fehler! Textmarke nicht definiert.
circuit plans 4/4	Fehler! Textmarke nicht definiert.
RF-output board	Fehler! Textmarke nicht definiert.
layout plan	Fehler! Textmarke nicht definiert.
circuit plans 1/2	Fehler! Textmarke nicht definiert.
circuit plans 2/2	Fehler! Textmarke nicht definiert.
layout plan	Fehler! Textmarke nicht definiert.
circuit plans 1/3	Fehler! Textmarke nicht definiert.
circuit plans 2/3	Fehler! Textmarke nicht definiert.
circuit plans 3/3	Fehler! Textmarke nicht definiert.
Coag-Modul	Fehler! Textmarke nicht definiert.
layout plan	Fehler! Textmarke nicht definiert.
circuit plan 1/3	Fehler! Textmarke nicht definiert.
circuit plan 2/3	Fehler! Textmarke nicht definiert.
circuit plan 3/3	Fehler! Textmarke nicht definiert.
handpiece recognition	Fehler! Textmarke nicht definiert.
layout plan	Fehler! Textmarke nicht definiert.
circuit plans 1/2	Fehler! Textmarke nicht definiert.
circuit plans 2/2	Fehler! Textmarke nicht definiert.
mains board	Fehler! Textmarke nicht definiert.
layout plan	Fehler! Textmarke nicht definiert.
circuit plans 1/2	Fehler! Textmarke nicht definiert.
circuit plans 2/2	Fehler! Textmarke nicht definiert.
high power supply	Fehler! Textmarke nicht definiert.
layout plan	Fehler! Textmarke nicht definiert.
circuit plans 1/3	Fehler! Textmarke nicht definiert.

¹ not valid for A-3000/ -2000
² not valid for Arco-2000

³ not valid for MBC600
⁴ not valid for Arco-1000

circuit plans 2/3	Fehler! Textmarke nicht definiert.
circuit plans 3/3	Fehler! Textmarke nicht definiert.
gas control¹	Fehler! Textmarke nicht definiert.
layout plan	Fehler! Textmarke nicht definiert.
circuit plans 1/2	Fehler! Textmarke nicht definiert.
circuit plans 2/2	Fehler! Textmarke nicht definiert.
synchronization board¹	Fehler! Textmarke nicht definiert.
layout plan	Fehler! Textmarke nicht definiert.
circuit plans 1/2	Fehler! Textmarke nicht definiert.
circuit plans 2/2	Fehler! Textmarke nicht definiert.
Frontpanel Arco/HF[*]	Fehler! Textmarke nicht definiert.
layout plan	Fehler! Textmarke nicht definiert.
circuit plans 1/1	Fehler! Textmarke nicht definiert.
layout plans	Fehler! Textmarke nicht definiert.
circuit plans 1/1	Fehler! Textmarke nicht definiert.
layout plans	Fehler! Textmarke nicht definiert.
circuit plan 1/1	Fehler! Textmarke nicht definiert.
Interfacekarte	Fehler! Textmarke nicht definiert.
layout plan	Fehler! Textmarke nicht definiert.
circuit plans 1/2	Fehler! Textmarke nicht definiert.
circuit plans 2/2	Fehler! Textmarke nicht definiert.

¹ not valid for A-3000/ -2000
² not valid for Arco-2000

³ not valid for MBC600
⁴ not valid for Arco-1000

1. Overview

1.1 General description of the Arco-units, MBC-units

The RF-surgery equipment makes the following applications available to the user.

- Cutting in steps 1-5⁴
- Cutting with Blend-function in steps 1-5⁴
- Coagulation modes
 - Soft⁴
 - Force⁴
 - Spray⁴
- Argon inertgas¹
- Bipolar Coagulation^{2,4}
- Bipolar Cutting^{2,3,4}

The desired mode is roughly selected on the front panel by 5 pre-select buttons and can then be fine adjusted by arrow buttons. The desired mode can be activated by footswitch or fingerswitch at the handpiece.

Application of function fields **monopolar**⁴ and **bipolar**^{2,4} is as follows:

- a) If **monopolar**⁴-handpieces with fingerswitches are used, an activation of the **bipolar**^{2,4} functions Cutting and Coagulation is possible by means of a double footswitch. Both function fields are thereby useable. In this case both indicator fields are active.
- b) If **monopolar**⁴-handpieces without fingerswitches are used, only one of the function fields can be activated. The use of both functions with one footswitch is possible, but in order to switch from one function to the other a manual selection at the equipment is necessary.

For more detailed description of the control- and indicator-elements see instruction manual.

The **Arco** -respectively **MBC**-units were only meant for the use in general surgery and gastroenterology. Operations on the heart, eyes and in the brain (neuro-surgery) are not admissible!!!

This equipment has not been developed for continual operation (constant power-supply for a longer period). The period for use fulfills the minimum demands for operation of the EN60601-2-2 (10s load, 30s break).

Before starting operation the supplies of the appropriate handpieces must always be checked for external damages. Only accessories from the Söring Accessories Order List are allowed to be applied to the unit. We take no liability for accessories of other manufacturers.

¹ not valid for A-3000/ -2000
² not valid for Arco-2000

³ not valid for MBC600
⁴ not valid for Arco-1000

Used symbols

Patient electrode (when RF applied Pt-electrode insulated against earth)



Defibrillator safe



Attention!, see also covering documents



Monopolar Cutting & Coagulation⁴



out (separation from main)



Argon Enhanced Coagulation¹



on (connection to mains)



Bipolar^{2,4} Cutting³ and Coagulation



type CF



potential equation pin



CE-label acc. to 93/42/EWG



Attention high voltage



Double Footswitch^{1,4}

¹ not valid for A-3000/ -2000
² not valid for Arco-2000

³ not valid for MBC600
⁴ not valid for Arco-1000

1.2 Co-operation of units

The equipment contains the following units:

- Electrical components

- Primary power supply unit: transformer, line-filter, power switch and parts of mains board
- mains board with low-voltage power supply, mains relays and voltage selector switch
- High-power supply
- Cut -module incl. Interface
- Coagulator-module incl. Interface
- RF-output module incl. Handpiece allocation, PE-monitoring and bipolar recognition^{2,3,4}
- Handpiece recognition
- Gas control¹
- Synchronization board¹
- Front panel (modular design)
- Micro controller (CPU)

-Mechanical components

- Gas system¹

The wiring of the modules and their cooperation is shown on the following block diagram and the voltage-supply plans. Power is connected to the mains power socket, which contains the mains fuses and a parasitic suppresser filter. Via the mains switch the power goes to the mains board. This contains a voltage selector and an inrush current limiter (a resistor, which is short-circuited after approximately 1 second). The mains voltage goes to the primary winding of the transformer. It feeds the low-voltage power supply and via a separate rectifier bridge and smoothing capacitors the high power supply. These two units are also placed on the mains board together with a low voltage power supply.

The power supply of the other modules is provided by two different power supplies. The low-voltage power supply (on mains board) feeds front panel, microprocessor, handpiece recognition and RF-output module. The high-power part, consisting of coagulator- and cut-module, is fed by the high-power supply.

The power modules deliver RF-signals to the RF-output module (HFO). Here the RF-signal first passes through a power measuring device, is then converted to the necessary output voltage by means of an output transformer and is finally switched to the desired handpiece by the allocation relay. Furthermore the RF-output module contains checking circuits for the PE-contact check and a tissue contact detection for the bipolar output.

The handpiece recognition (HSE) delivers information regarding type of connected handpiece respectively its switch functions to the CPU via the handpiece bus. The sensing of footswitches is also performed by this module.

The CPU-board (microprocessor) controls the complete sequence of the equipment. It gets information about the desired mode from the front panel modules via an I²C-bus. The power modules (high-power supply, cut- and coagulator module) are controlled by a parallel module control bus. The check of actual voltage of the high-power supply as well as the status of the power modules is done via the module status bus, which connects the power modules with the RF-output. This information is transferred from the RF-output module to the CPU via the status bus.

The relay control, check of delivered output power, status of PE-electrode and tissue contact recognition on the RF-output module is done via the I²C-bus.

In order to protect the software functions the CPU-board is connected to a microprocessor watchdog and a voltage monitor on the power supply board.

The control of argon gas flow supplied to the handpiece is performed by the gas control board located at the CPU-board. Gas control is carried out by the CPU via the I²C-bus.

¹ not valid for A-3000/ -2000
² not valid for Arco-2000

Arrangement of modules of the Arco-3000

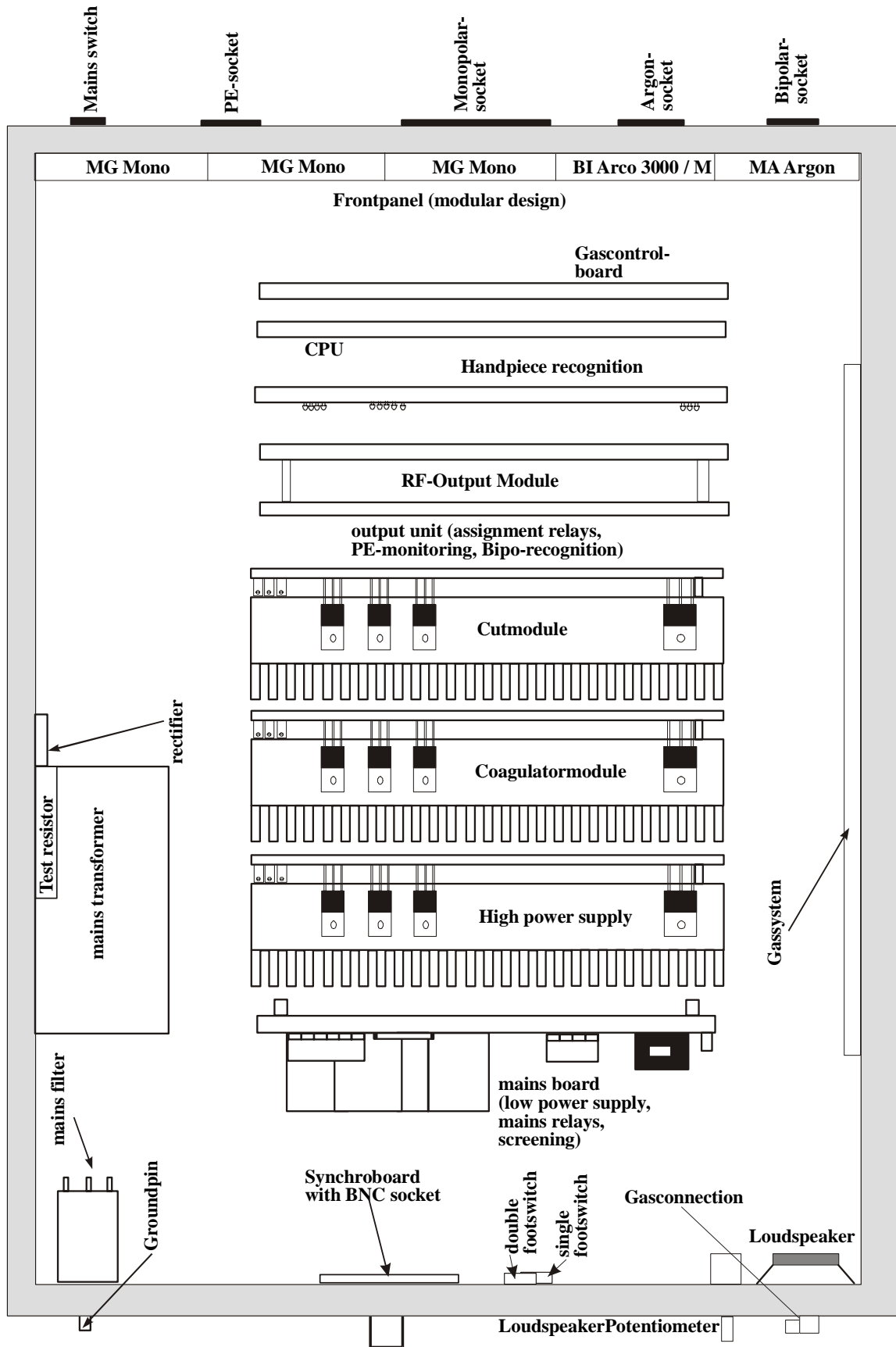

¹ not valid for A-3000/ -2000
² not valid for Arco-2000

³ not valid for MBC600
⁴ not valid for Arco-1000

Arrangement of modules of the Arco-2000

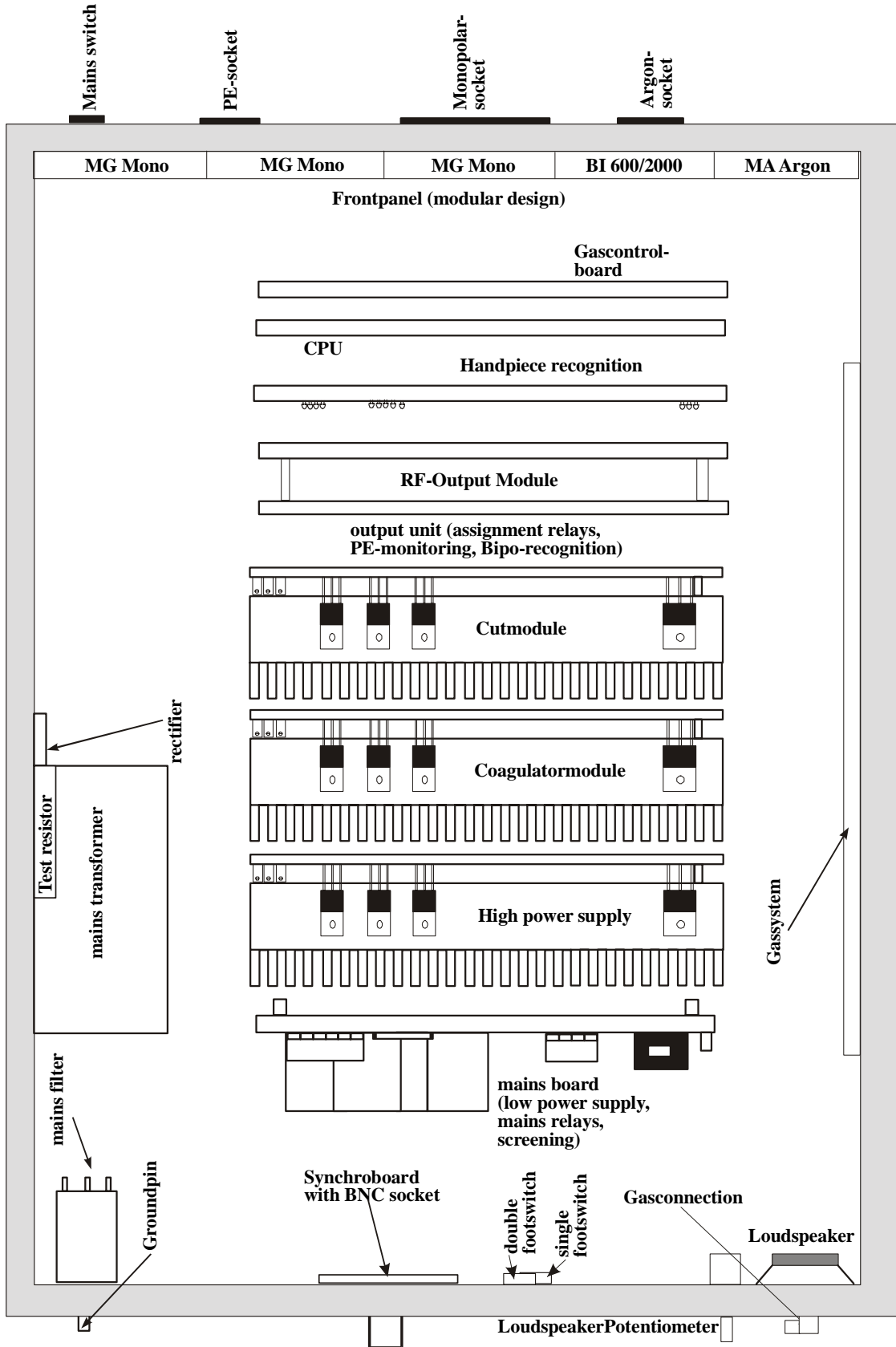

¹ not valid for A-3000/ -2000
² not valid for Arco-2000

³ not valid for MBC600
⁴ not valid for Arco-1000

Arrangement of modules of the Arco-1000

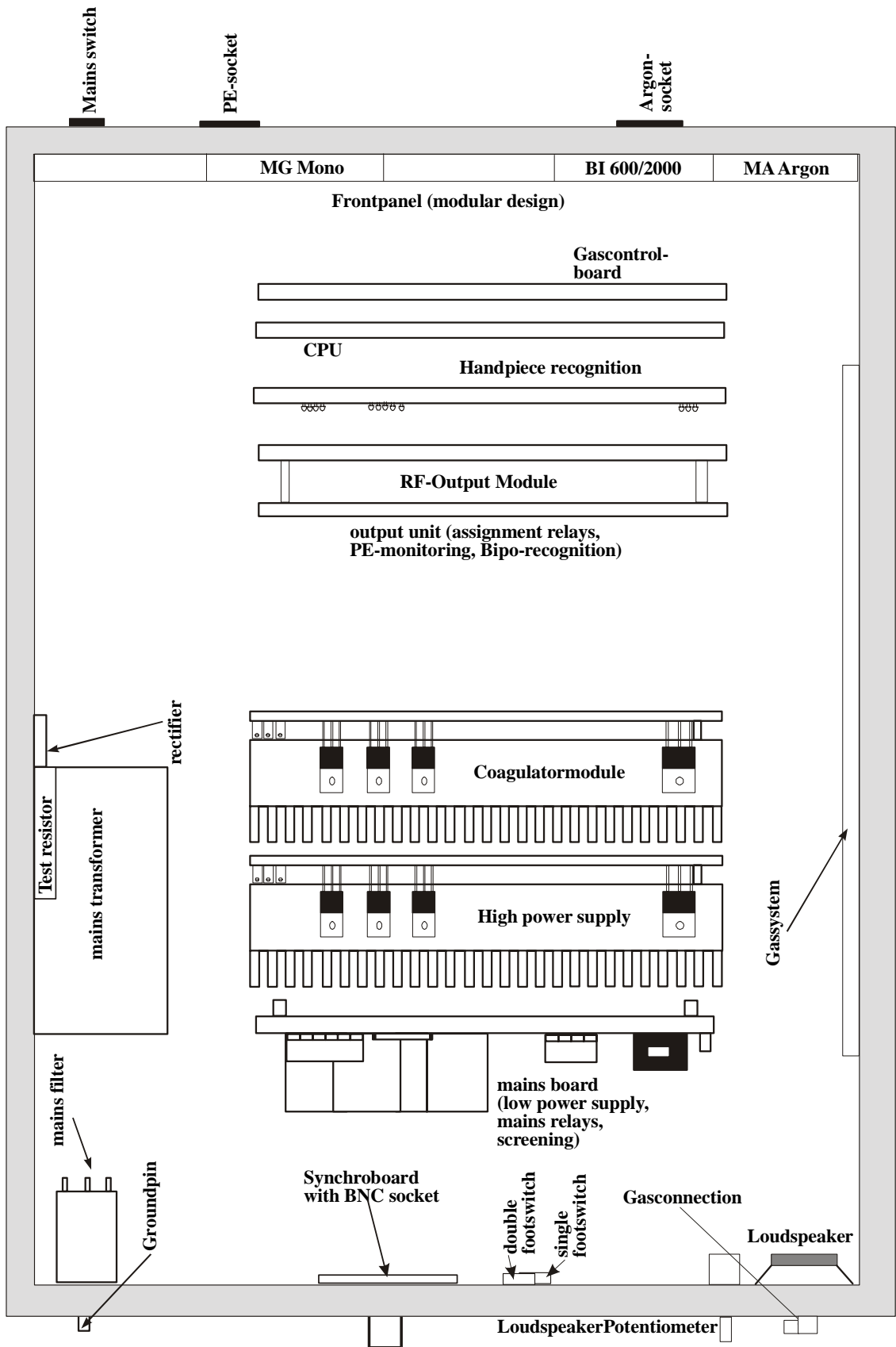

¹ not valid for A-3000/ -2000
² not valid for Arco-2000

³ not valid for MBC600
⁴ not valid for Arco-1000

Arrangement of modules of the Arco-1000 Table-Top

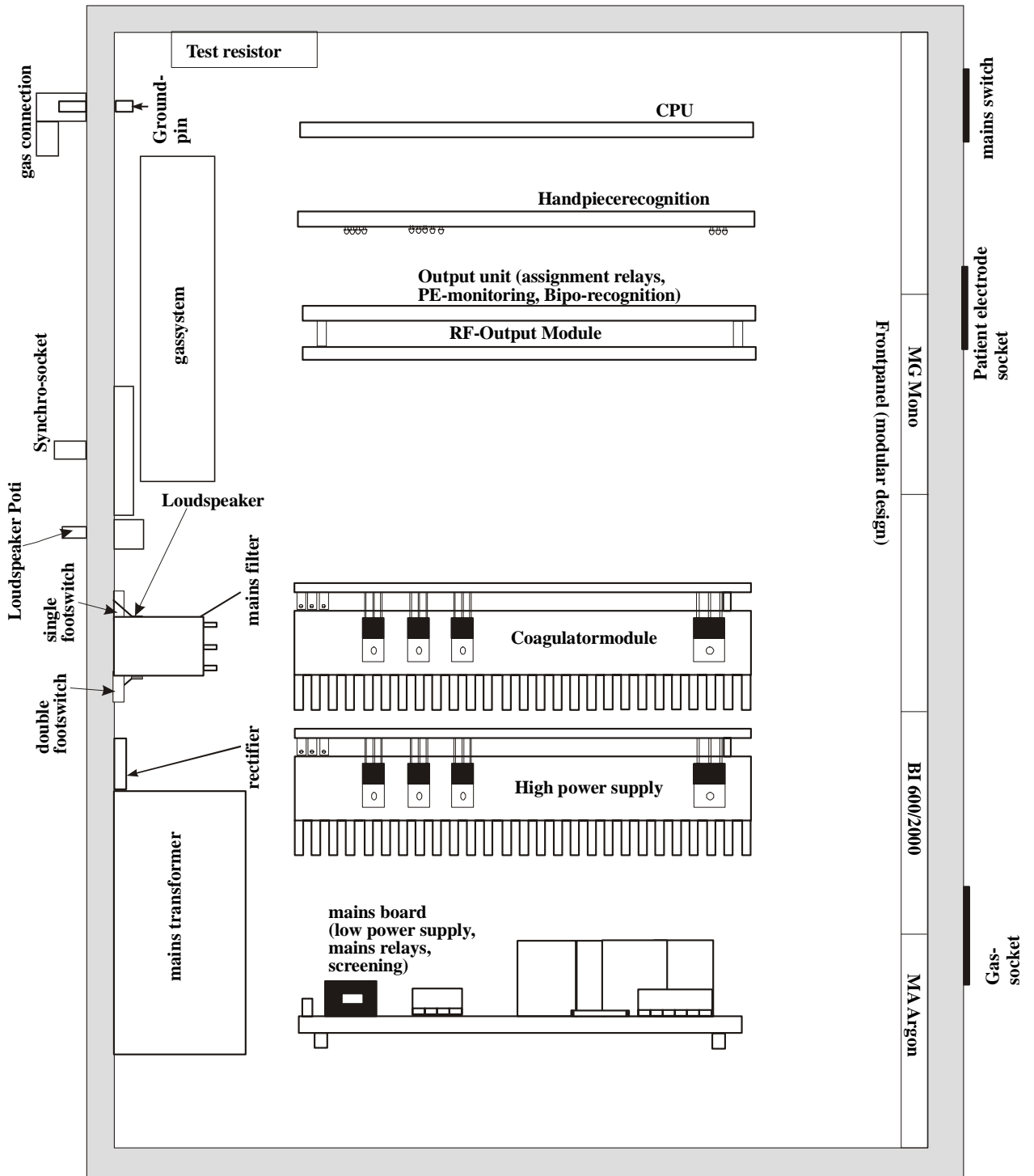

¹ not valid for A-3000/ -2000
² not valid for Arco-2000

³ not valid for MBC600
⁴ not valid for Arco-1000

Arrangement of modules of the MBC 601

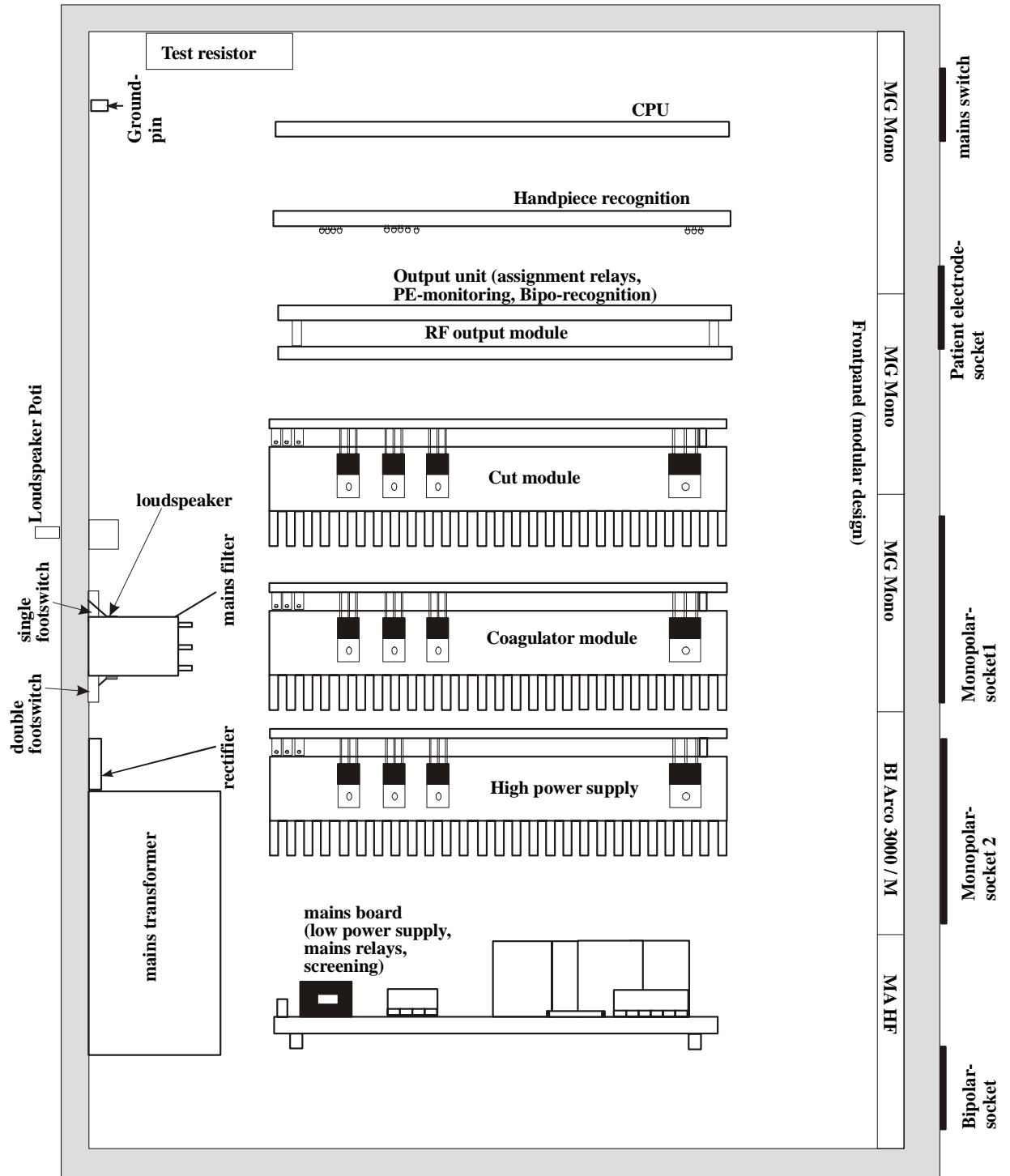

¹ not valid for A-3000/ -2000
² not valid for Arco-2000

³ not valid for MBC600
⁴ not valid for Arco-1000

Arrangement of modules of the MBC 600

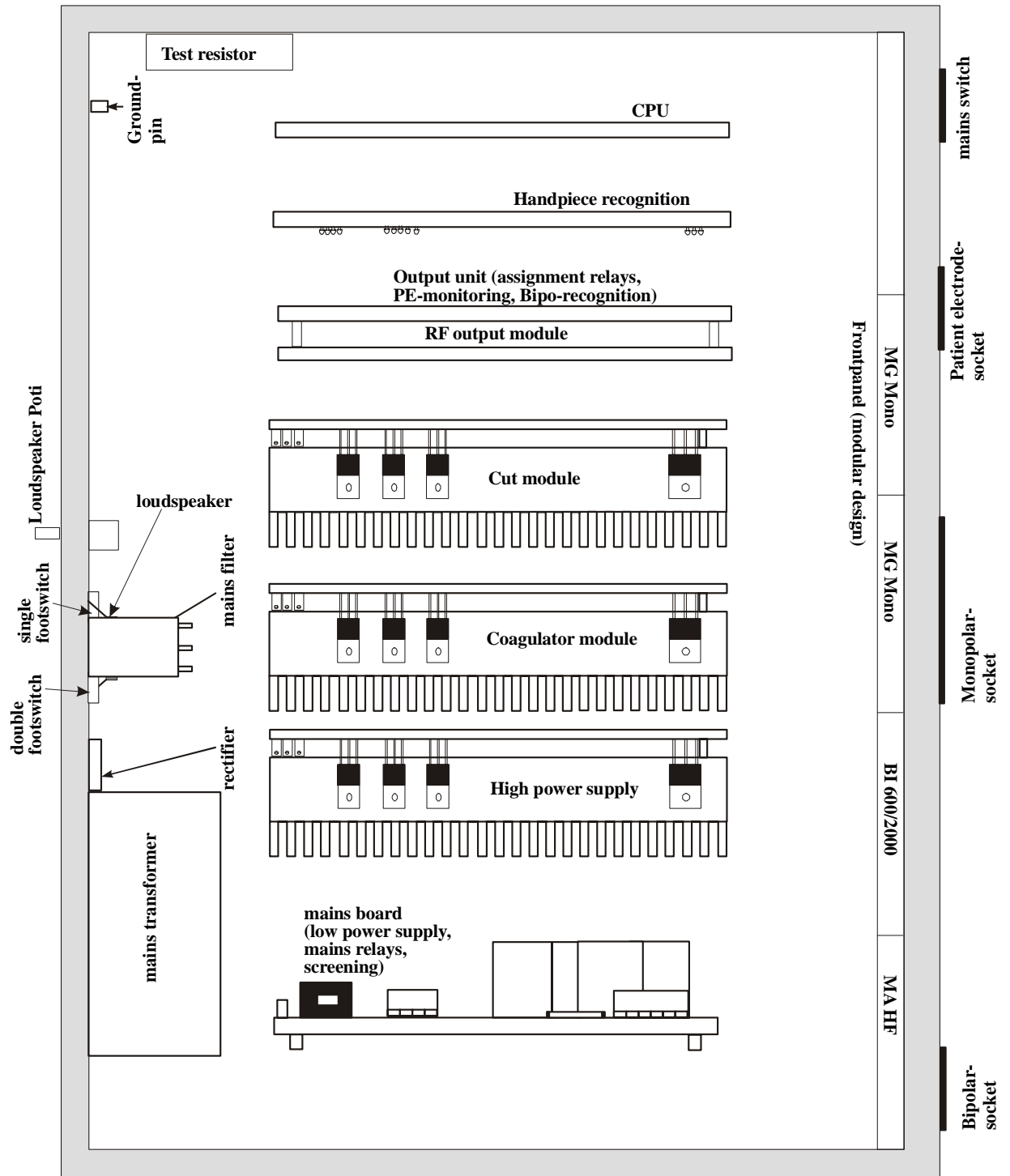

¹ not valid for A-3000/ -2000
² not valid for Arco-2000

³ not valid for MBC600
⁴ not valid for Arco-1000

Block diagram of units

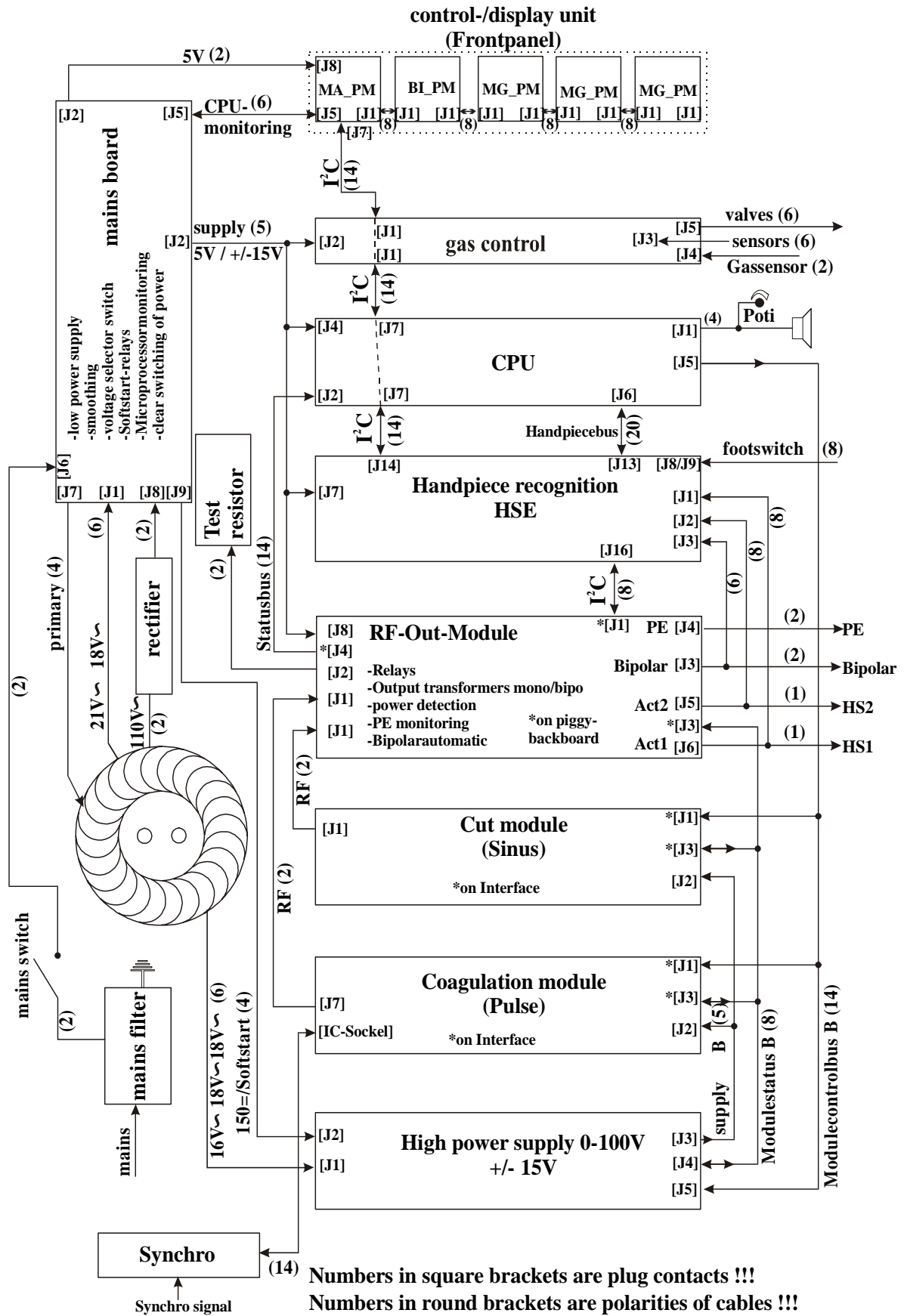

¹ not valid for A-3000/ -2000
² not valid for Arco-2000

³ not valid for MBC600
⁴ not valid for Arco-1000

Block diagram primary current supply of the units

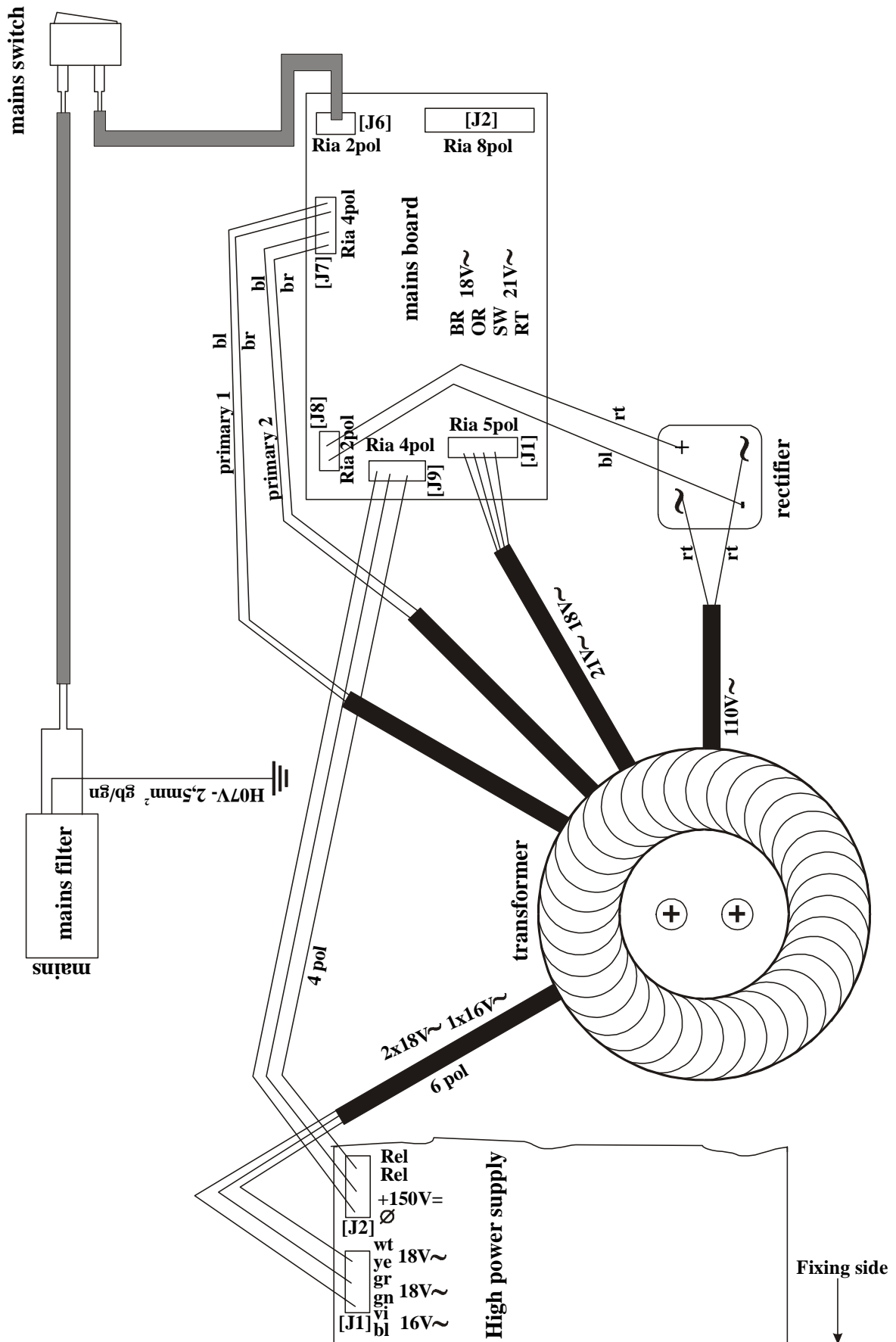

¹ not valid for A-3000/ -2000
² not valid for Arco-2000

³ not valid for MBC600
⁴ not valid for Arco-1000

Description of units

The corresponding circuit diagrams can be found in the annex

2. Primary power supply

The primary power supply consists of:

- Mains adapter with fuse-holder and filter
- Mains power-switch
- Inrush current limiter and voltage selector on mains board
- Mains transformer

2.1 Description of power supply board

The following units are placed on the power supply board:

- A) -Voltage selector 115/230 V.
-Inrush current limiter
- B) -Smoothing and disconnecting switch
- C) - $\pm 15V$ and +5V source with voltage monitoring
- D) -Microprocessor- and voltage monitoring

A) -Voltage selector 115/230 V and Inrush current limiter.

Voltage selector:

The voltage selector is a switch for the serial or parallel connection of two 115V primary windings of the mains transformer.

Inrush current limiter:

When the equipment is switched on, the mains current first flows through a current limiting resistor.

After the delay time has passed, the resistor is short circuited by a relay. If the relay fails, the two thermal fuses connected in series to the resistor melt and disconnect the primary circuit.

B) Smoothing and disconnecting switch:

The rectified voltage (approx. 150VDC) is smoothed by 4 electrolytic capacitors. These feed the high-power supply via a fast-blow 6.3A fuse and a disconnect switch (MOS-transistor), which is optically isolated controlled by the watchdog- and low-voltage monitor circuit. The disconnect switch only closes if the microprocessor-monitor does not generate a reset signal and the CPU delivers the necessary trigger signals.

C) $\pm 15V$ and +5V source:

This unit generates +15V, -15V and +5V and feeds the electronic circuits (except the circuits of the power modules).

The secondary winding (22VAC/50Hz) of the mains transformer is connected to the rectifier via fuse SI1 and thermal fuse SI3.

The rectified voltage is smoothed and stabilized to +15V and +5V by means of two switching regulators. The +15V and +5V circuits are normally protected by fuse SI1.

Another secondary winding of the mains transformer (19VAC/50Hz) is rectified, smoothed and stabilized to -15V by means of a fixed voltage regulator. The -15V circuit is protected by fuse SI2.

¹ not valid for A-3000/ -2000
² not valid for Arco-2000

³ not valid for MBC600
⁴ not valid for Arco-1000

Voltage monitoring:

-+5V-source:

Over voltage protection: This unit is activated if the 5V-source exceeds the limit (+10%). In case the limit, determined by a zener diode, is exceeded, a thyristor is fired and short-circuits +5V to the thyristor voltage (1.2V).

In case of permanent short circuit the thyristor is protected against overheating (>85°C) by the thermal fuse SI3, which is thermally coupled to the thyristor. If the temperature at the thyristor exceeds 85°C, fuse SI3 melts and interrupts the connection to the 22VAC/50Hz.

Under-voltage protection: If the voltage of the +5V source is less than 4.65 V, the μ -monitor-IC (MAX691A) sends a reset signal to the CPU.

-±15V source:

If the voltages exceed or fall below the limits +15V±10% or -15V±10%, the unit sends a reset signal to the CPU. The unit works with voltage comparators and reference voltages given by zener diodes.

D) Microprocessor-monitoring

An external watchdog WD1 monitors the quartz frequency of the CPU. At intervals of 200ms the CPU sends a trigger signal to WD1. If the interval exceeds 240ms or falls below 160ms the watchdog transmits a trigger signal to the CPU. Simultaneously the disconnect switch interrupts the feeding of the power supply. Furthermore the CPU is halted by a reset, if the above mentioned voltage monitor is activated.

Power supply watchdog: With the power supply watchdog the supply voltage of the high-power supply (disconnect switch) can only be switched on, if the CPU periodically sends a trigger pulse in 200ms intervals. A reset signal of the CPU generally switches off the disconnect switch.

¹ not valid for A-3000/ -2000
² not valid for Arco-2000

³ not valid for MBC600
⁴ not valid for Arco-1000

Block diagram mains board 1/2

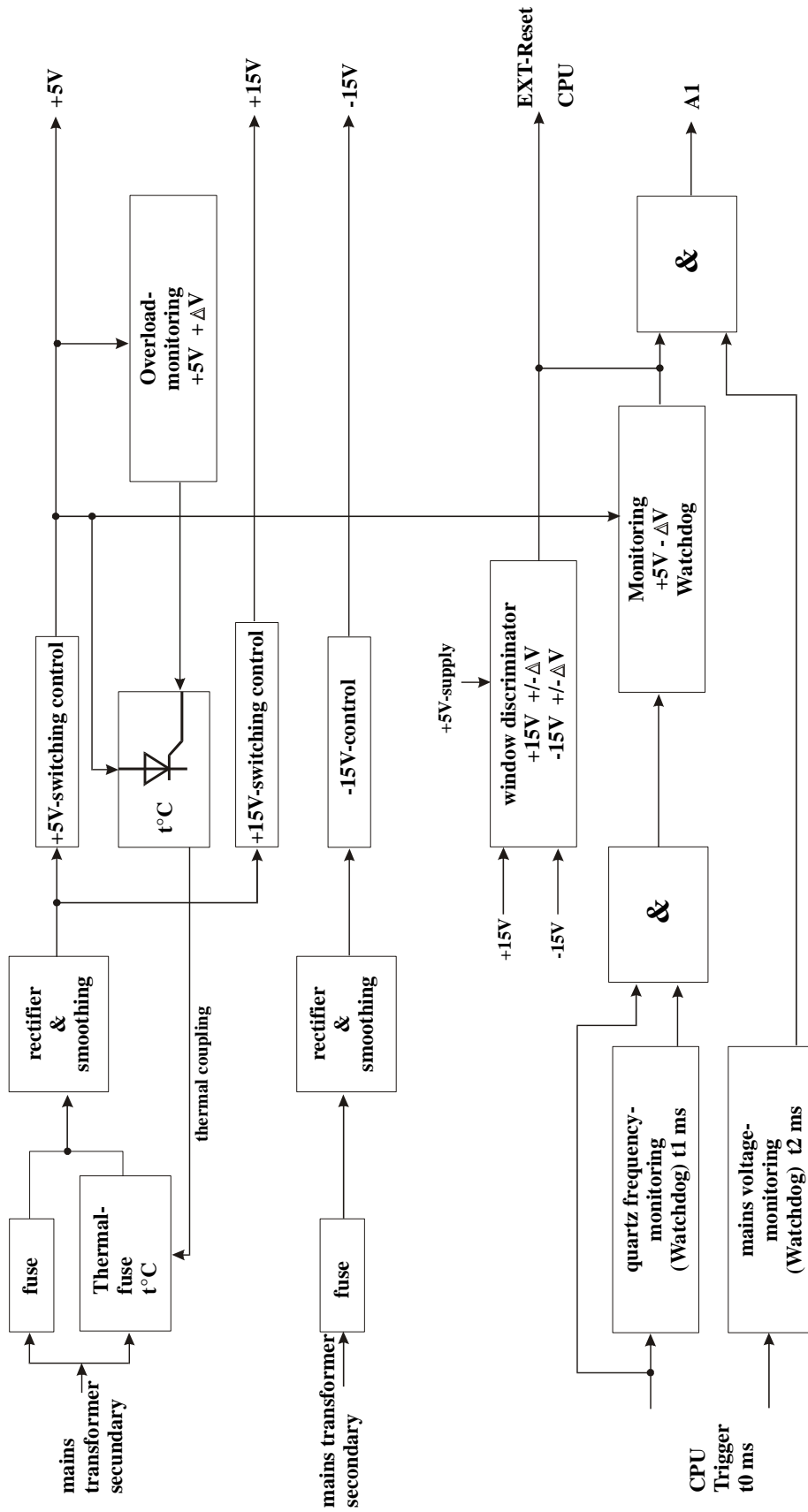

¹ not valid for A-3000/ -2000
² not valid for Arco-2000

³ not valid for MBC600
⁴ not valid for Arco-1000

Block diagram mains 2/2

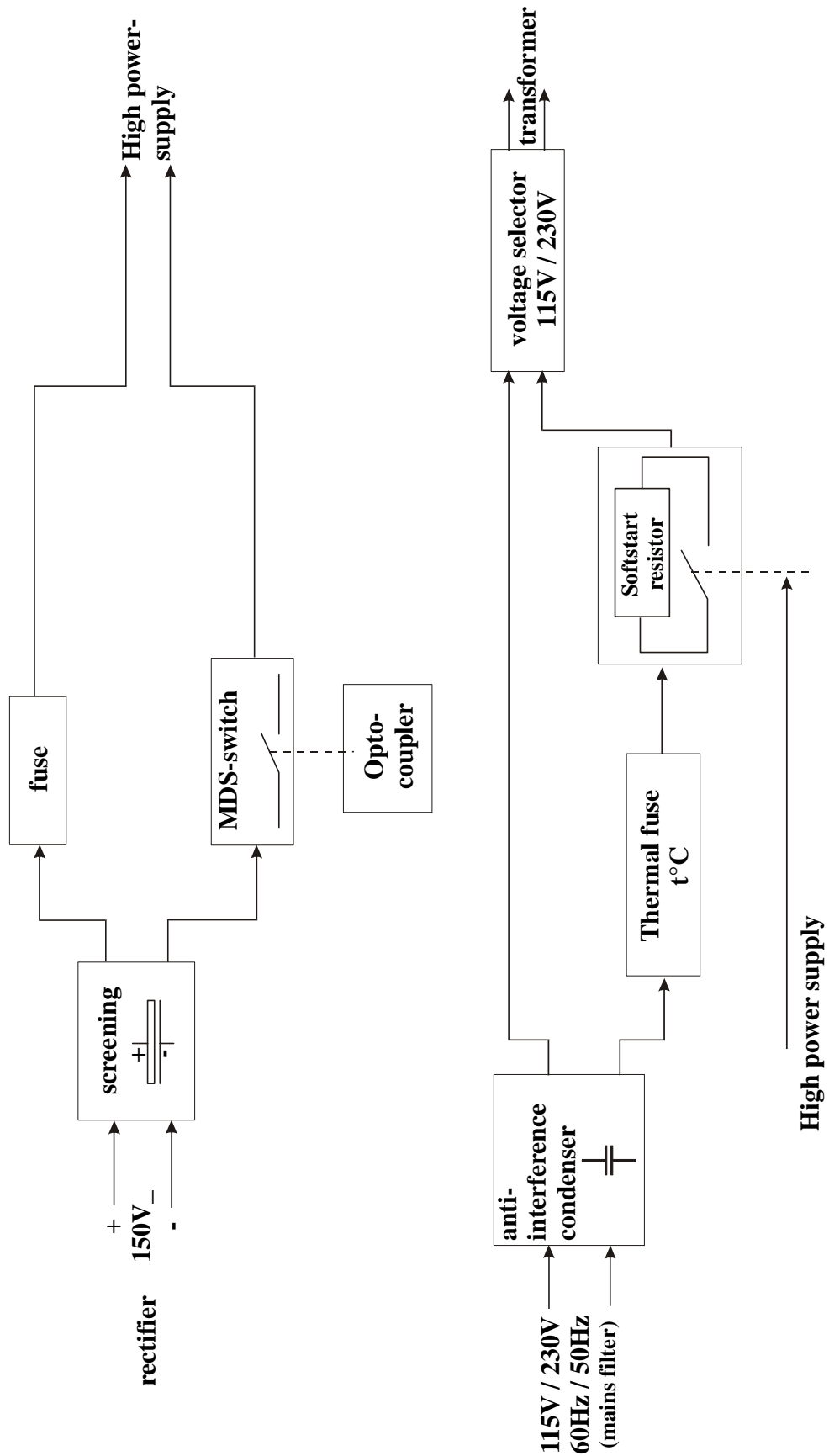

¹ not valid for A-3000/ -2000
² not valid for Arco-2000

³ not valid for MBC600
⁴ not valid for Arco-1000

3. Description of microcontroller unit, board CPU

3.1. General description

The CPU is the central control-system of the equipment. It gets information from other units by parallel data-lines or via the I²C-bus. Data output is performed via the addressable systembus, by pulse-with modulated signals or as for data input by parallel data-lines respectively the I²C-bus. Analogue input-data are digitized by the processor. An output for connection of loudspeakers is provided. Furthermore there is a possibility to communicate with other equipment via a serial interface.

3.2. Connection to other units

3.2.1. Connection to frontpanel

The CPU is connected to the frontpanel via the I²C-bus. Input of commands is done by reading the different I²C-input-chips. Output of data for display is done by writing to the corresponding I²C-output-chips. Furthermore, the CPU-board delivers power to the frontpanel.

3.2.2. Connection to handpiece recognition unit

Data transfer between CPU and handpiece recognition unit is done via parallel data-lines. The handpiece recognition unit needs support from the CPU in order to detect a handpiece. Different possibilities about the wiring of the connected handpiece are investigated and the result of this investigation is passed back from the handpiece unit to the CPU. The CPU is thereafter in a position to identify the correct handpiece. As an additional function the handpiece recognition unit delivers the status of footswitches over the data-lines.

3.2.3. Connection to high-power supply

The high-power supply receives its information about the voltage desired over the equipment-bus. There is no further direct connection to the high-power supply.

3.2.4. Connection to Cut-module⁴

The Cut-module receives its control-information via the equipment-bus. A function check of the Cut-module is performed indirectly by the current consumption of the high-power supply.

3.2.5. Connection to Coag-module

As the Cut-module the Coag-module is also controlled via the equipment-bus. The monitoring is also made indirectly by checking the supply-current.

3.2.6. Connection to relay board

The relay board is the central distributor for the RF-power currents. Controlling is done via the equipment-bus. A relay connects an input-module to a handpiece. All other handpieces and the other RF-module are disconnected, thereby obtaining an optimum on functional safety.

Furthermore the relay board sends the power-supply data current, voltage and mains breakdown to the CPU. Measurement of RF-leakage current delivers the RMS-value of the leakage current as an analogue signal to the CPU. Exceedance of the limit is transferred to the CPU as a digital signal.

¹ not valid for A-3000/ -2000
² not valid for Arco-2000

³ not valid for MBC600
⁴ not valid for Arco-1000

3.2.7. Connection to the mains relay board

The control-board is connected to the CPU by a parallel data-line. It transfers the control signal for the gas system. The CPU gets the information "tube obstructed" and "gas shortage" via this connection. The gas values are delivered by the gas control board.

¹ not valid for A-3000/ -2000
² not valid for Arco-2000

³ not valid for MBC600
⁴ not valid for Arco-1000

Block diagram CPU board

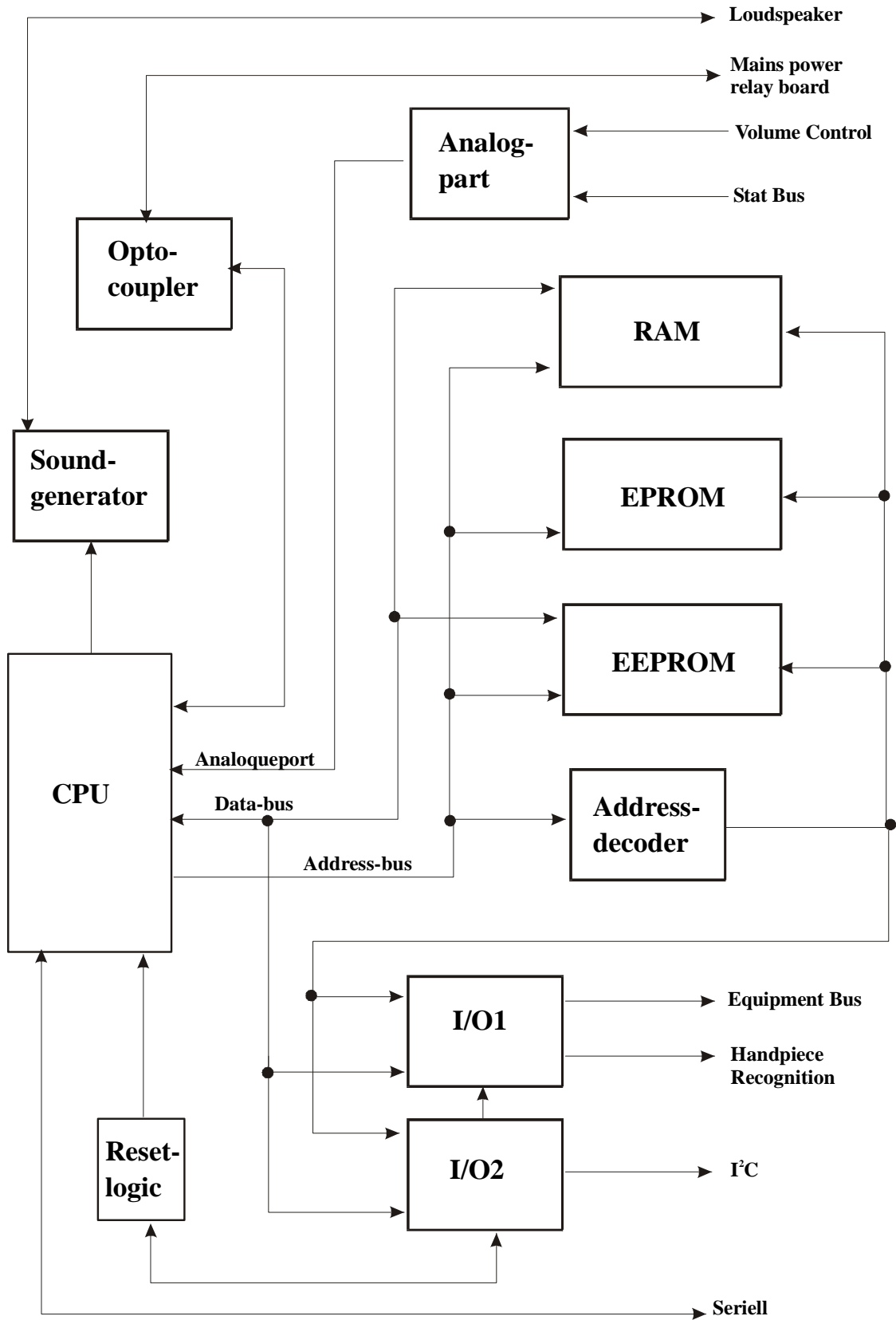

¹ not valid for A-3000/ -2000
² not valid for Arco-2000

³ not valid for MBC600
⁴ not valid for Arco-1000

4. Description of front panel

4.1. General description

The front panel contains the push-buttons and switches necessary to operate the equipment and displays the actually selected values. Furthermore relevant information regarding safety and function is displayed. The front panel is composed of different panel modules. Depending on type of equipment the number varies between 3 and 5 modules. The indicators of the panel are controlled via the I²C-bus. (As an exception the LED's for Output-power error and Function error are controlled via parallel data lines.)⁴

Keyboard scanning is also done via the I²C-bus. The suppression of key bouncing is done by the CPU.

The panel gets its supply-current alternatively from the CPU-connection or from a connection to the low-voltage supply.

4.2. Connection to other units

4.2.1. Connection to CPU

The front panel is connected to the CPU by the I²C-bus. The initiative for a data transfer is exclusively taken by the CPU.

4.2.2. Connection to low-voltage supply

In order to avoid unnecessary loading of the CPU connection by high currents the displays of the panel are fed from a separate power supply (5V). Furthermore the connection of the CPU with the microprocessor monitoring of the power supply is carried out via the front panel module "MA" (Master).

¹ not valid for A-3000/ -2000
² not valid for Arco-2000

³ not valid for MBC600
⁴ not valid for Arco-1000

Block diagram Frontpanel

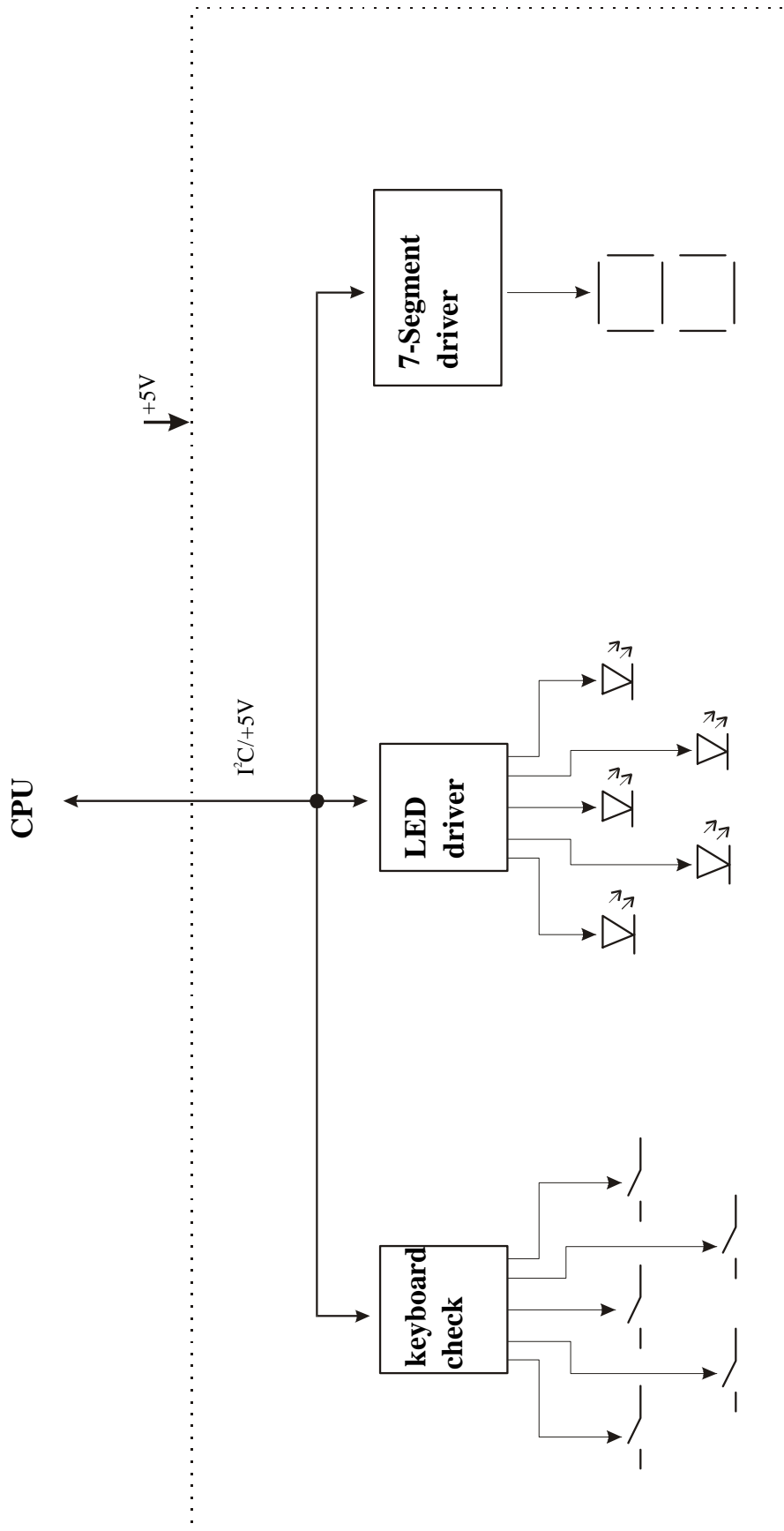

¹ not valid for A-3000/ -2000
² not valid for Arco-2000

³ not valid for MBC600
⁴ not valid for Arco-1000

5. Description of high-power supply

5.1. General description

Purpose of the high-power supply is the feeding of the power modules. It delivers three voltages, two of these are fixed voltages: +15v and -15v and one is a variable voltage of 0 - 80v controlled by the CPU with a resolution of 6 bit via the equipment bus. In order to produce only little heat the high-power supply is designed as a switching regulator. Furthermore this board contains the following components:

- Analogue signal output of momentary current and voltage values in order to detect overload respectively an output power error at the patient.
- Short-circuit-/overload-protection of the switching regulator.

5.2. High-power supply, design and function

The module is supplied with 2 x 18v~ and 1 x 15v~ from the mains transformer via a 6-pole plug. These voltages are rectified, filtered and stabilized to $\pm 15v$ and 12v by means of fixed voltage regulators and supply the internal circuits. The voltages +15v and -15v are led out for supplying the Cut- and Coagulator-module. Via another plug smoothed but unregulated 130v= are fed to the MOS-switch. By varying the duty cycle the MOS-switch together with its storage-choke and freerun diode delivers the desired output voltage. The regulation is done by comparing the actual voltage to the nominal voltage. The nominal voltage comes from the processor interface which contains the necessary address decoding, galvanic isolation (opto-coupler) and a D/A-converter.

The current limiter limits the current to 7a by switching-off the MOS-switch. If the current limiter is continuously active for more than 0.3 to 0.4 seconds, e.g. due to a defective module or extreme overload, the switching regulator is switched off for approx. 5 seconds and then restarted.

The value of the mains-transformer voltage (15v-winding) is monitored before the smoothing capacitor for the limits $\geq 15v$ and $\leq 27v$. In case of overvoltage or undervoltage the monitoring circuit cuts off the switching regulator and delivers a power-fail signal.

¹ not valid for A-3000/ -2000
² not valid for Arco-2000

³ not valid for MBC600
⁴ not valid for Arco-1000

5.3. Technical data

- **Inputs**

- 2 x 18v~, 1 x 15v~ from 3 separate windings of mains transformer
- input voltage switching regulator, range 100 - 150v, normally approx. 130v from mains relay board. Voltage smoothed and unregulated.
- Data from microcontroller over the equipment-bus
- Signal Down: Down-regulation of output voltage independent from microcontroller. Signal range -0.7 to +15v.

- **Outputs**

- Output voltage variable, determined by microcontroller, 0 to 80v, max. current 7a, short-circuit proof. Voltage selection with 6-bit resolution (step 1.25v).
- Fixed voltages: -15v, +15v, max. load 400 ma. Accuracy $\pm 5\%$.
- Signal Power-Fail: Emitter and collector of an optocoupler. Optocoupler switched, if Power-Fail = 1.
 - for 0.5 seconds after switching-on
 - for the time of power failure +0.5 seconds after power failure
 - Power failure: at least 20 msec outside $\pm 20\%$ of nominal mains voltage
- Signal U_{out} : Signal with 1/10 of output voltage for monitoring of equipment and output power error
- Signal I_{out} : Signal proportional to actual output current with 1a/v for monitoring of output current

- **Miscellaneous**

- Protection
 - Switching regulator electronically protected by shutdown after short-circuit. Restart after 5 seconds.
 - Fixed voltages by solid-state fuses
- Efficiency: $\geq 90\%$
- Accuracy: Output voltage switching regulator $\pm 1v$ over the entire load- and adjustment-range

¹ not valid for A-3000/ -2000
² not valid for Arco-2000

³ not valid for MBC600
⁴ not valid for Arco-1000

Block diagram High power supply

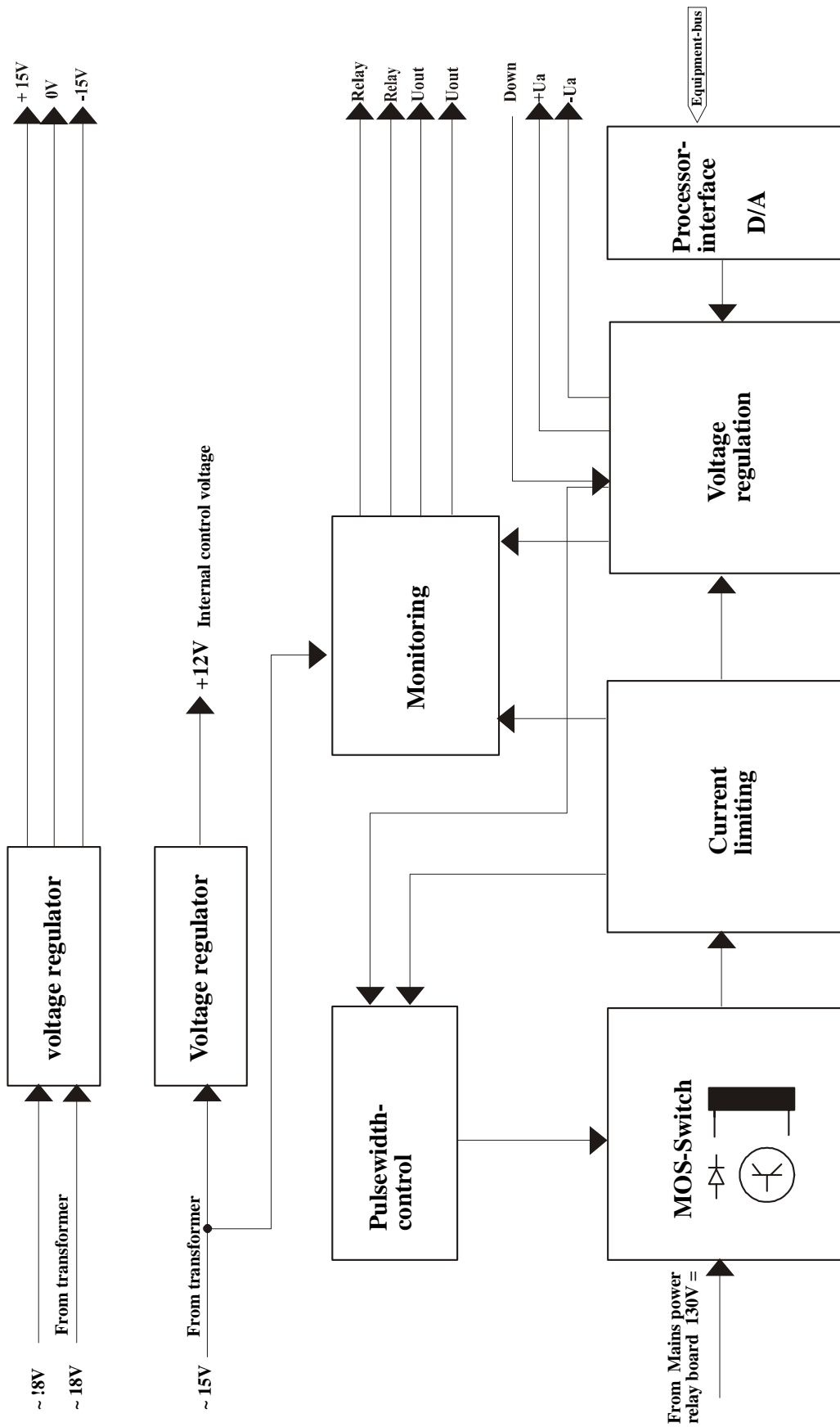

¹ not valid for A-3000/ -2000
² not valid for Arco-2000

³ not valid for MBC600
⁴ not valid for Arco-1000

6. Description of Cut-module⁴

6.1. General description

The cut-module delivers the RF-signal for the cutting process. Furthermore the signals for contact coagulation (desiccation, respectively force coagulation) are generated. For pure cutting a sinusoidal signal of approx. 350kHz with low distortion is used. The maximum output voltage is 70V. By means of an output transformer on the RF-output module it is transformed to 420V (monopolar) respectively 280V (bipolar). The maximum output current is 1.2A, the maximum output power is 350W. In order to enhance coagulation during cutting (Blend), the signal can be pulsed. The pulse repetition frequency is variable within the range 20 to 400Hz. The duty cycle can be adjusted from 0 to 100%. Thereby a variation between pure coagulation, coagulating cut and pure cut is possible. In order to enhance the quality of cutting different types of tissue the module possesses an arc detection and regulation. Due to an internal power- and current limiter the CPU is relieved from these control tasks. If the module is used for coagulation, the arc detector switches off for a short time (programmable from approx. 0.5 to 100ms) in case an arc occurs, so that an arc would extinguish immediately, thereby preventing unwanted cutting into the tissue. With this function coagulation with a pure sine is possible.

The module consists of:

- Final stage (MOS-bridge)
- Output filter (distortion suppresser)
- Power detection (broadband multiplier)
- Effective current detection (indirectly by the current through the final stage)
- Arc detection (detection of harmonics by the arc)
- Control circuits for current, power and arc regulation
- Spark suppression (by immediate short timed disconnection of final stage, sparks in connection with short circuits at the generator output are avoided)
- Control logic for pulse generation etc.
- Communication with microprocessor (function modes, parameters and returned values) as well as with high-power supply (signal DOWN module status bus for down regulation of supply voltage) is done by the interface board, which is mounted on the cut module as an additional board.

6.2. Final stage and output filter

The final stage consists of the MOS-power transistors T3 to T6. These four transistors are bridge-connected. From the driver transformer TR2 the transistors T3/T6 and T4/T7 are periodically switched on. This results in a periodic switching of the supply voltage (+U_SUP, -U_SUP). Thereby the output voltage is a rectangular signal with an amplitude proportional to the supply voltage. With TR1, a transformer with air gap and defined inductance, the capacitors C119 to C121 (serial resonant circuit) and L2, C122 and C123 (parallel resonant circuit) the rectangular signal is filtered to a sinusoidal signal with low-distortion. The resonance frequency is approx. 350kHz. The rectangular signal is tuned to this frequency. As the capacitance of the connection cable is different for monopolar and bipolar operation, correctional capacitors can be switched in by a relay. This reduces the reactive current and thereby the losses in the final stage. The signal is then routed via the current transformer TR3 to the output socket. TR4 acquires the actual output voltage for power registration.

¹ not valid for A-3000/ -2000
² not valid for Arco-2000

³ not valid for MBC600
⁴ not valid for Arco-1000

6.3. Oscillator and driver

IC7 works as an oscillator with a frequency of approx. 350kHz. The frequency is adjusted by potentiometers P3 and P4 independently for monopolar and bipolar operation. This is necessary because the transformation ratio of the output transformers for mono- and bipolar mode and the patient protection capacitors influence the series capacitance of the output resonant circuit. This results in slightly different resonance frequencies. The oscillator is followed by a 2-stage driver circuit T53, T54, T1 and T2. Now the driving power is sufficient to drive the final MOS-bridge via the driver transformer TR2.

6.4. Switching stage

The switching stage connects or disconnects the power supply of the MOS-bridge, thereby switching it on or off. It consists of the MOS-transistor T7. This transistor is controlled by the driver T9 and T10 which again is controlled by the AND-gate (CMOS) IC1. Only if the three inputs of this gate are simultaneously high, the final stage is switched on.

6.5. Short circuit switch-off

This circuit switches off the final stage within microseconds in case a maximum current is exceeded. The final stage is thereby protected against overload in case of short circuit and spark development when short circuiting the bipolar tweezers is significantly reduced. As the current through the MOS-bridge is nearly proportional to the output current, this current is used for determining the RF-output current. The final stage current goes through resistor R121 (0.1Ω). The voltage drop over this resistor is amplified by operational amplifier U1a and U1b. The analog switch IC4a serves as a range switch. If the measured current (Signal I_VAL) exceeds the reference value (I_SET), the output of comparator U5a goes high and switches off the final stage for a short time. The Maximum current I_SET is transferred to the cut module in analog form from the interface board.

6.6. Current limiting, current control

The current limiting circuit limits the output current to the maximum value given by the signal I_SET (see above). The current regulation is performed by reducing the power supply voltage by the control signal DOWN. This signal is routed to the high-power supply via the interface board. The current value I_VAL acquired by the operational amplifiers U1a and U1b is compared by the operational amplifier U1c with half the value of I_SET (Signal I_SET/2). As long as I_VAL, the actual current value, is less than I_SET/2, U1c delivers approx. 14V. If I_VAL is larger than I_SET/2, the output voltage drops more and more. The signal is passed via D49 and R440 to the DOWN output. If the DOWN-signal falls below a certain voltage (0 to 10 V), the power supply voltage, given by the micro-controller is down regulated, the RF-output voltage falls and reduces the RF-output current to the maximum value given by I_SET. Current limiting is indicated by LED D50. In pulse mode the analog switch IC4 disconnects during the switch-off phases of the final stage the actual value from the regulator and keeps the regulator output constant during the current pauses. This prevents an up-regulation of the RF-output voltage during the current pauses (hold function). If the module is switched off the down-regulation of the power supply is prevented by switching off the current reference (IC4b).

¹ not valid for A-3000/ -2000
² not valid for Arco-2000

³ not valid for MBC600
⁴ not valid for Arco-1000

6.7. Power limiting

The power limiting circuit consists of the power measurement and the power regulation. The regulator works exactly the same way as for current limiting (analog switch IC3c and PI-regulator with U1d) and acts also on the DOWN-signal. Power measurement is done with a voltage- and current signal, retrieved from TR3 (current) and TR4 (voltage). Both RF-signals (RF_CURR and RF_VOLT) are multiplied in real time by a broadband multiplier U7. As the Multiplier delivers only 300mV/100W, an amplification with the operational amplifiers U2a, U2b and U2c is necessary, before the power signal can be passed to the PI-regulator U1d via the analog switch. Due to the large adjustment range of power from 1 to approx. 500W, a regulation only by preset value (P_SET) is insufficient (instability at low preset values). Therefore the amplification of the power signal for the multiplier is switched in 8 range steps. This is done by the analog switch IC5 and the resistors R412 to R419. By means of P2 the offset of the multiplier and the operational amplifier U2a is adjusted to zero. Beginning of power limiting is transferred to the microprocessor by the signal PREG via the interface board IF02.

6.8. Arc regulation

Cutting of tissue is only possible, when the RF-voltage at the active electrode is so high that a fine arc occurs between electrode and tissue. If no arc is achieved, only coagulation of tissue occurs. The voltage at the active electrode, necessary for an arc, depends on kind of tissue and geometry of electrode. If the cut-voltage is increased beyond the necessary value, the intensity of the arc rapidly increases and the tissue burns. When operating from muscles to fatty tissue, the arc can extinguish, so that the electrode sticks. The presence of an arc can be sensed by harmonics in the cutting-current, due to nonlinear effects. The higher the harmonics content, the stronger is the arc intensity. If the arc intensity is too high, the RF-voltage has to be reduced and it has to be increased in case of a too small arc. In this module the arc intensity is retrieved from the cut-current signal RF_CURR. The signal RF_CURR is passed through R136 to the operational amplifier U4.

By means of a reactive current simulation, which simulates and subtracts the stray capacitance of the handpiece cables and the inductive currents of the output transformers (capacitors C132, C133, resistors R137 to R142 and relay for the different conditions under monopolar and bipolar applications), the current signal (C_SIG) goes to 2-quadrant multiplier U8 for amplitude regulation. After appropriate amplification (U6a, U6b, final stage T15, 16) the amplitude is evaluated (difference amplifier U3a, D22 and D23 etc.), and passed to a PI-regulator (U3b). This regulates the output voltage (signal CURR_SIG) to a value, independent of cutting current. This signal contains the fundamental and possible harmonics, caused by the arc. It is rectified after high-pass filtering by R377, C309 and L1. The resulting voltage is proportional to the harmonic contents in the cut signal and corresponds to the arc intensity during cutting. This actual signal and the reference signal are routed via the analog switches IC3a and -b to the PI-regulator U2d, which regulates the power supply down at too high arc intensity (signal DOWN). The down regulation is notified by the signal SPREG to the interface board IF02 and thereby to the microprocessor for evaluation.

6.9 Pulse generation and control logic

The following operational modes are known to the control logic:

- Cutting
- Coagulation
- continuous operation
- pulsed operation

¹ not valid for A-3000/ -2000
² not valid for Arco-2000

³ not valid for MBC600
⁴ not valid for Arco-1000

6.10 Signal shapes

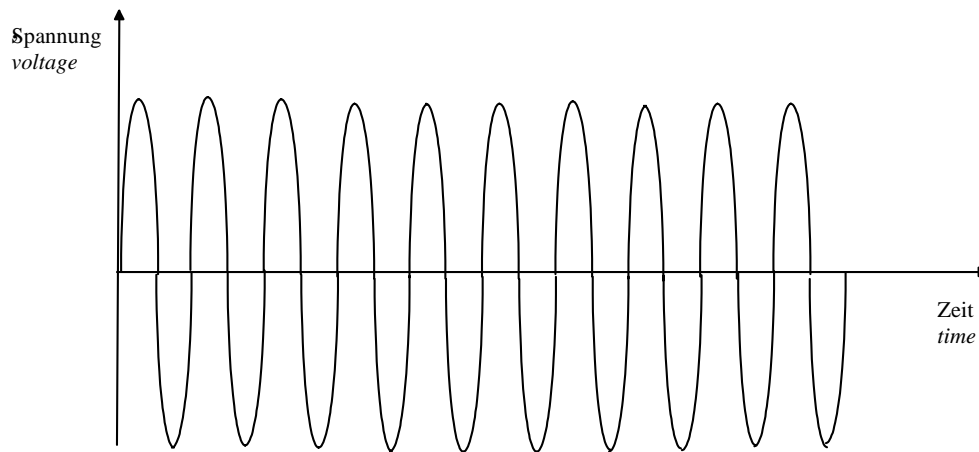

This signal-shape is used for the function Cutting without Blend

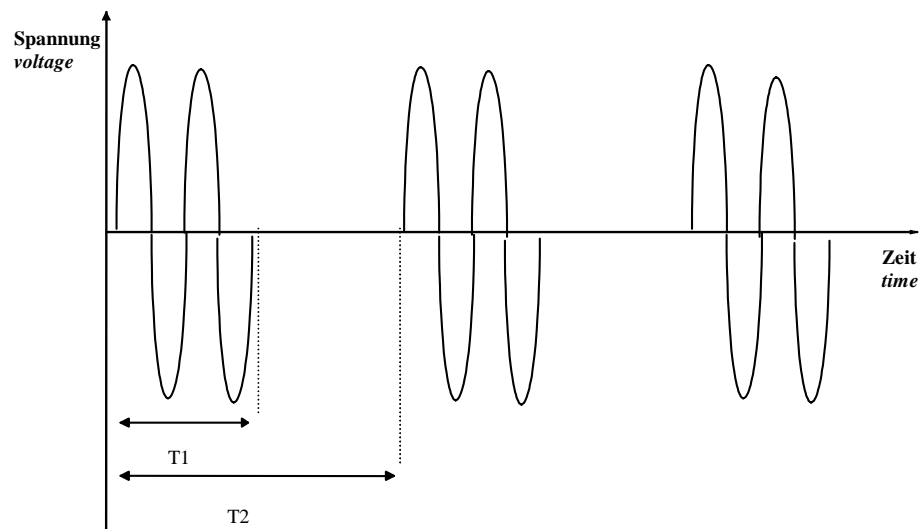

Pulse-modulated RF-current, duty-cycle $3/8 = 37,5\%$

This signal-shape is used for the function Cutting with Blend

¹ not valid for A-3000/ -2000
² not valid for Arco-2000

³ not valid for MBC600
⁴ not valid for Arco-1000

Block diagram Cut module

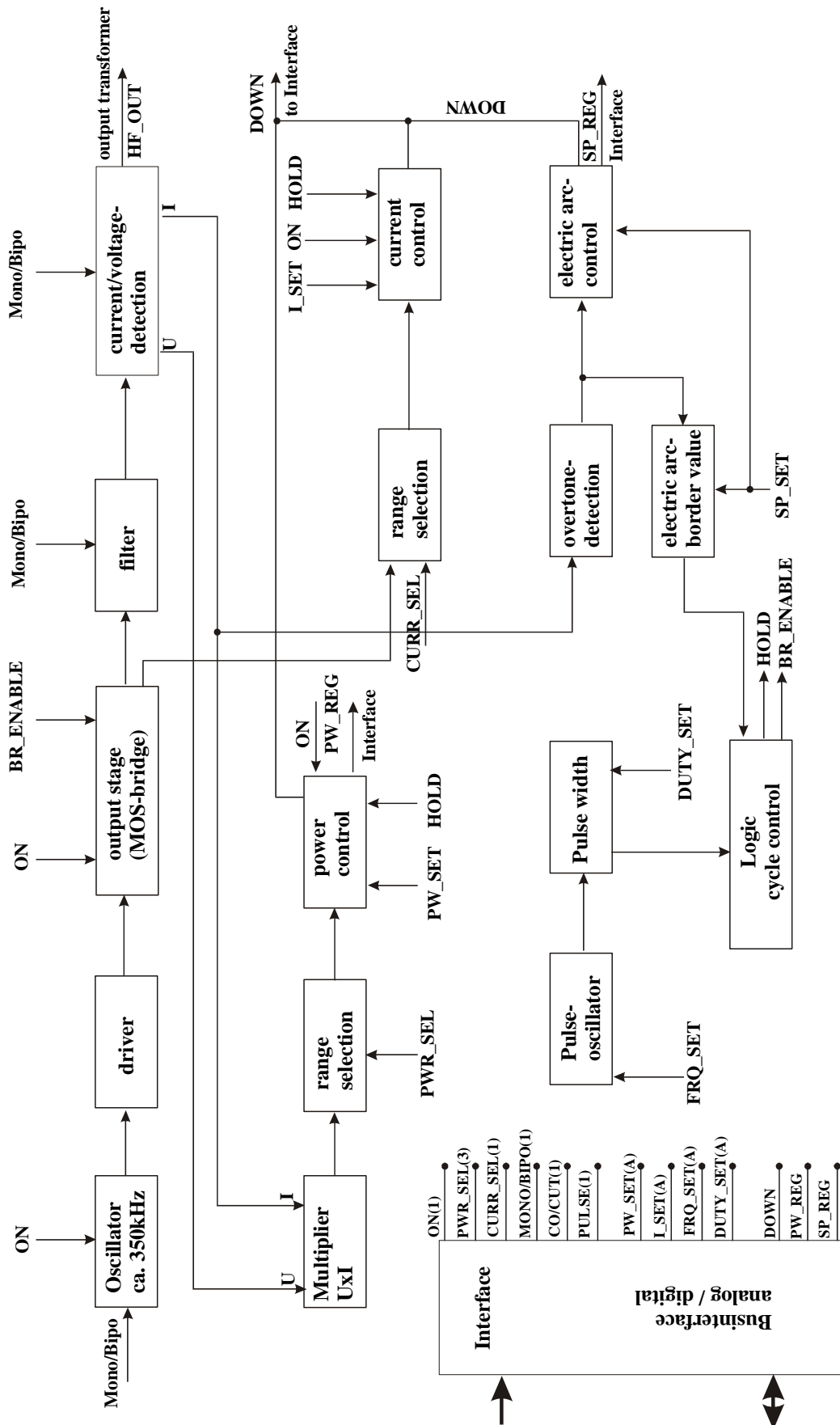

¹ not valid for A-3000/ -2000
² not valid for Arco-2000

³ not valid for MBC600
⁴ not valid for Arco-1000

7. Description of RF-output module

7.1. General description

The RF-out module transfers the RF-signal of the cut- and coagulator module to the handpieces and monitors the delivered RF-power. It consists of the two boards HFO_A and HFO_B. The first board (HFO_A) contains the output transformers necessary for the supply of monopolar and bipolar handpieces, the relays needed for allocation of radio-frequency and the measuring transformers for power measurement and PE-electrode contact check. By means of another relay the RF-current can be switched to a measuring resistor for checking of the cut- and coagulator module. This allows testing of the RF-modules and the RF-power measurement by the self test after switching on the equipment.

The second board (HFO_B) contains the I²C-interfaces for relay control and the necessary analog multipliers and DACs for power measurement etc. In order to check these analog interfaces, they can be tested mutually with different reference voltages. The design of the patient circuits complies with the CF-standard (PE-electrode potential free, i.e. without capacitive grounding).

7.2. Description of board HFO_A

The board HFO_A is the main board of the module. It contains all allocation relays for modules, handpieces and the power test resistor. Furthermore it contains the two output transformers (bipolar and monopolar) and the measuring transformers for power measurement and PE-electrode check.

The board gets the RF-signals from the cut- respectively Coagulator module and transfers the RF alternatively to the two monopolar outputs or the bipolar output. For testing the output power measurement and the RF-modules the output signal of the modules can be switched to a test resistor. The power supply ($\pm 15V$) for the relays and the piggy-back board is made via this board.

7.2.1. Design/function of board HFO_A

The radio-frequency from the cut- or coag-module enters the board via socket J1. Relay REL1 selects cutting or coagulation. REL2 switches RF to an external resistor of 4.7Ω for testing of the power measurement. The capacitors C1 to C4 simulate the patient safety capacitors. This is necessary for the correct function of the RF-modules with this test. The insertion of the test resistor before the output transformers is advantageous, because on the secondary side high voltage strength would be required. For safety reasons the idle position of REL2 (without voltage) always switches the RF to the test resistor. The relays REL3 and REL4 switch the RF to the monopolar respectively bipolar output. In idle position these relays switch the output transformers to tissue impedance test, signals MON_TST and BIP_TST. A circuit on the piggy-back board (HFO_B) can test the loop impedance between active and PE-electrode. The secondary of the bipolar transformer TR4 is connected to the tweezers via the two patient safety capacitors and socket J3. After the monopolar patient safety capacitors C5 and C6 the two handpiece allocation relays REL5 and REL6 are located. These relays connect the output alternatively to one of the handpieces. The relays are high voltage types.

In order to locate errors in handpiece allocation due to faulty relays (burnt contacts, wrong relay control), driver or software, the additional high voltage relays REL7 and REL8 are provided. By appropriate opening and closing of these relays with a simultaneous measurement of the loop impedance a complete test of these relays can be performed.

With closed relays REL5 and REL7 respectively REL6 and REL8 a capacitance check of the patient safety capacitors during self test is also possible. The RF flows back from the two patient electrode halves via the patient safety capacitors C7 and C8 and the

¹ not valid for A-3000/ -2000
² not valid for Arco-2000

capacitors C10 and C11 to the monopolar output transformer TR3. There are no more capacitive connections to the patient electrode. The transformer TR5 is used for loop impedance tests between the two halves of the patient electrode. This transformer as well as the other output transformers are designed for the applicable RF-voltages. Inserted into the RF-signal circuit are the two transformers TR1 and TR2. Transformer TR1 is a current transformer and TR2 a voltage transformer. With the corresponding signals the output power delivered by the RF-modules is checked. The evaluation is located on the piggy-back board (HFO_2). When controlling the relays by the relay driver IC1, the transistors Q1 and T1 block the relays in case REL_EN is at logical 1. This is the case, when the I²C-components have not yet been initialized after switching-on the equipment.

7.3. Description of board HFO_B

The board HFO_B is mounted as a piggy-back board on board HFO_A. It contains all necessary components for

- relay control
- RF-power measurement
- loop impedance measurement (PE-electrode,, monopolar/ bipolar)
- function test
- bus-interface (I²C)

7.3.1. Design/function of board HFO_B

The board contains the following units:

- Digital interfaces I²C-bus, IC1 and -2. IC1 controls the relays on the main board (Signals REL1 to REL8)
- IC2 delivers the release signal for the relays and the control of the multiplexer for testing the ADC and the test device for PE-contact recognition and tissue contact recognition monopolar and bipolar (impedance measurements).
- Analog to digital converter: I²C-chip IC3 for power measurement, PE-contact recognition and amplitude of test oscillator.
- Test device for checking all DAC's, also those of CPU- and handpiece recognition board HSE. (Multiplexer IC4 and IC5).
- Test oscillator with driver stage (U1, U5, T5 and T6)
- Reference processing (U2a)
- Monopolar/bipolar contact recognition (U7, IC5d and -e)
- PE-contact recognition (U6, U8c and -e) with testing device
- Power measurement, multiplier U11, U12, measuring amplifier U10 and low-pass U2

¹ not valid for A-3000/ -2000
² not valid for Arco-2000

³ not valid for MBC600
⁴ not valid for Arco-1000

Block diagram RF-Output Board /A

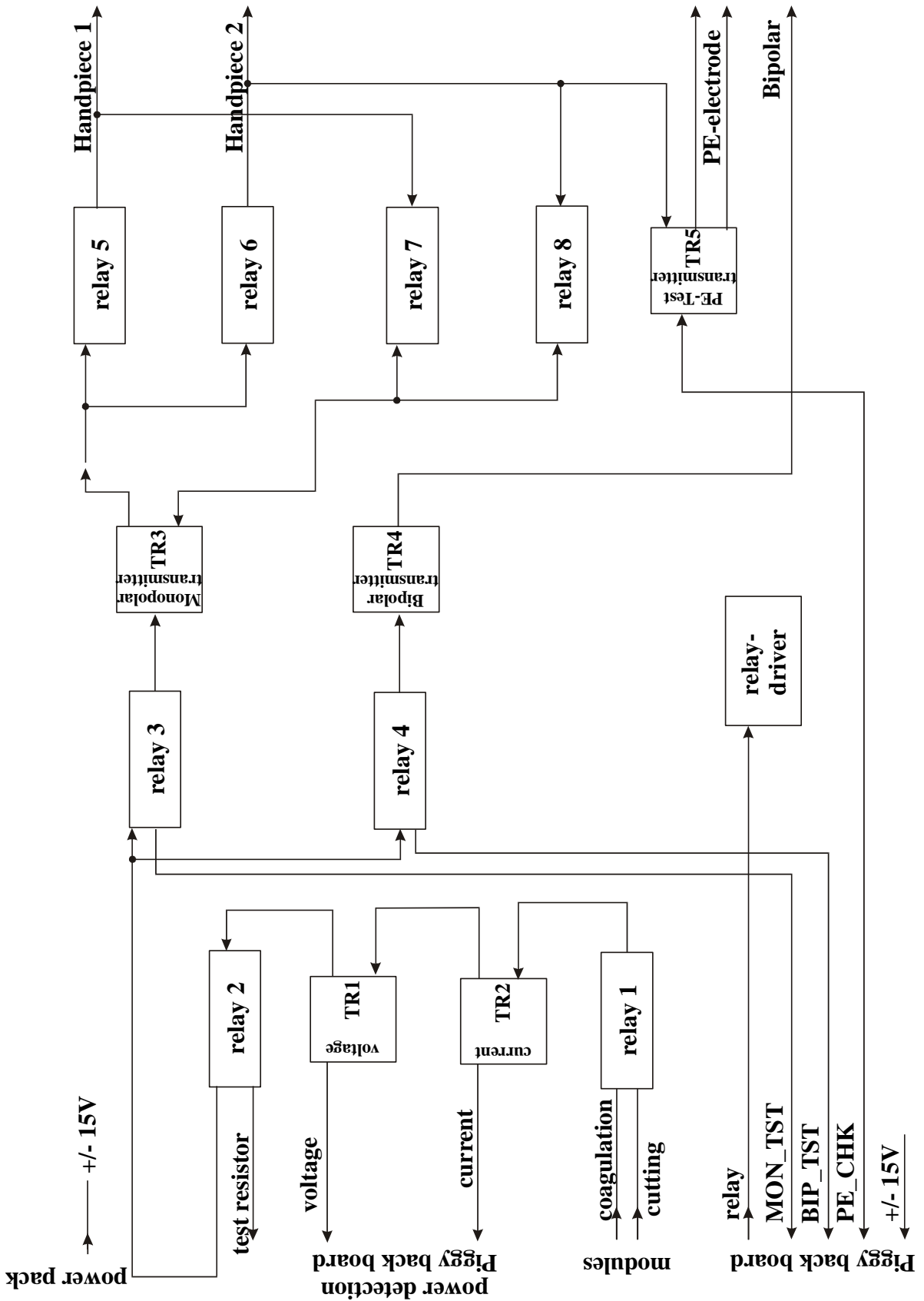

¹ not valid for A-3000/ -2000
² not valid for Arco-2000

³ not valid for MBC600
⁴ not valid for Arco-1000

Block diagram RF-Output board /B

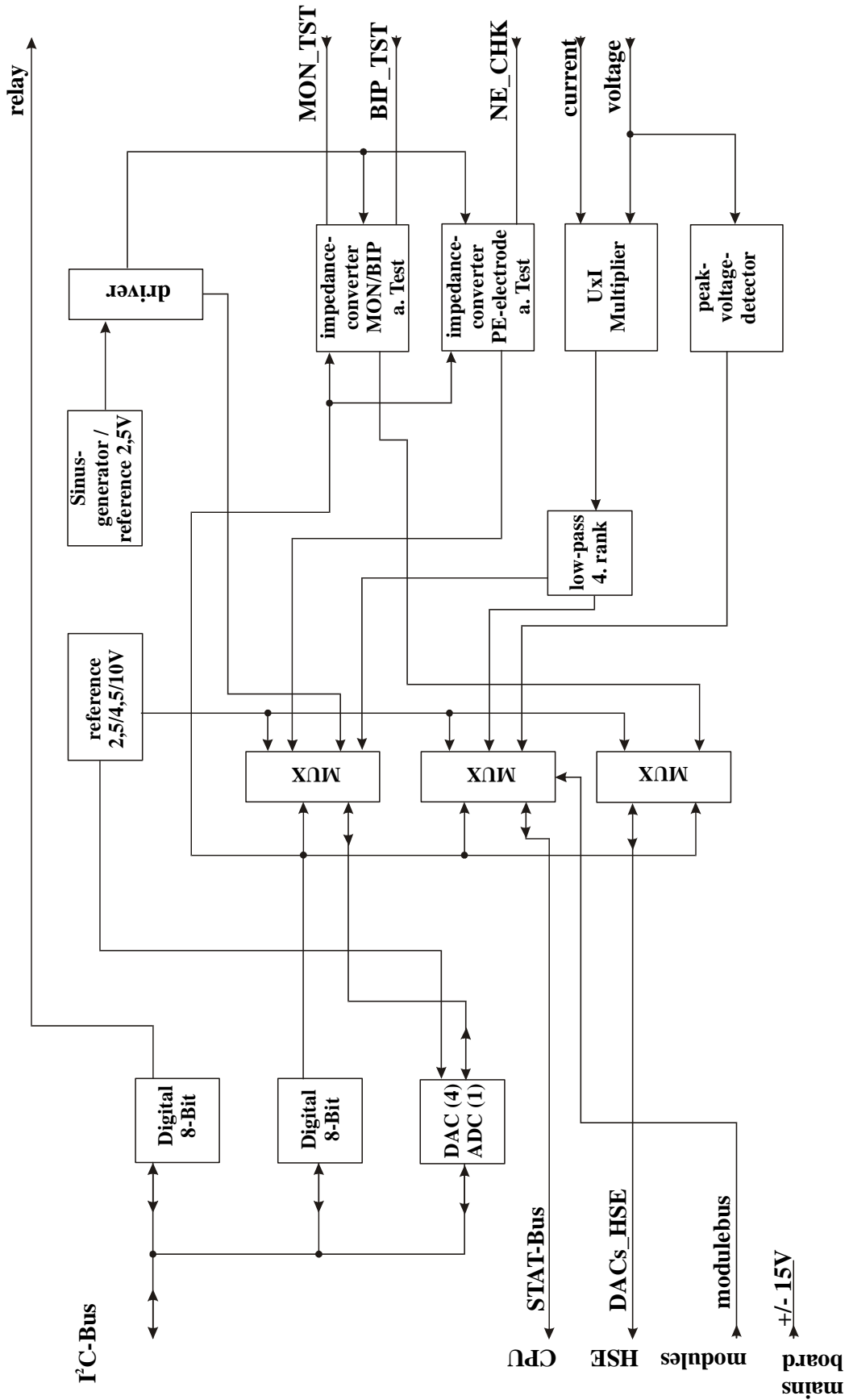

¹ not valid for A-3000/ -2000
² not valid for Arco-2000

³ not valid for MBC600
⁴ not valid for Arco-1000

8. Description of coagulator module

8.1. General description

The coagulator module provides the necessary high RF-voltage for spray coagulation. For changing the output power the pulse repetition frequency as well as the pulse energy is variable. In order to reduce disturbances of OP-equipment, especially endoscope cameras, not every output pulse is generated with an ignition energy necessary for spray coagulation. In order to reduce disturbing noise at low pulse frequencies, the ignition pulses are transmitted irregularly. An automatic spark detection enables the microprocessor to adjust the output parameters in such a way that the RF-leakage current is sufficiently low for all cases. A safety device informs the microprocessor about possible overheating of the output transformer. The module is designed for CF-operation.

8.2. Function of coagulator module

Fig- 9.1 shows the schematic concept of the coagulator module. It receives all the control information from the micro-controller via the interface board (see description interface board). Status information is transferred backwards via this board. Essentially the board contains a programmable oscillator, a pulse width modulator, a MOS-switch and a storage inductance. The longer the on-time of the MOS-switch, the more energy is stored in the storage choke, and the higher is the obtained voltage after switching off the transistors. By means of the output capacitors at the output transformer on the RF-output board a resonant frequency of more than 300 kHz is assured and a flow of not permissible low-frequency components through the patient is prevented.

In order not to dissipate the complete stored energy in the choke or the damping resistor in case of idling, a back transfer of energy into the power supply is made by means of a free run diode. A rectifier/clamp circuit charges the capacitors to the peak value of the voltage at the storage choke. If the required peak voltage is exceeded, the pulse length of the pulse width modulator is reduced by voltage regulators until the output voltage reaches the desired value.

By switching the clamp circuit by means of a switching transistor two different pulse voltages -Ignition pulses and standard pulses- can be generated. When the output is loaded, the pulse voltage drops and the pulse width increases to a "maximum" value. This maximum value corresponds to the pulse energy which is transferred to the tissue under load conditions (tissue contact respectively spark-over).

Together with the pulse frequency, also programmed by the micro-computer, the output power is defined. The spark-over recognition checks after an ignition pulse whether energy is back transferred via the free run diode to the power supply. If no energy is transferred back a spark-over is recognized. This is notified to the micro-controller. With activated frequency-automatic only then the pulse frequency is increased to the value given by the micro-controller in order to reduce the leakage current under idle conditions. By module selection the ignition pulse energy can be switched from the internal fixed value to the value given by the micro-computer. By program selection different ignition sequences, stored in an EEPROM, are available.

¹ not valid for A-3000/ -2000
² not valid for Arco-2000

³ not valid for MBC600
⁴ not valid for Arco-1000

8.3. Technical data coagulator module

- Output power: 5 - 150W by selection of pulse energy and frequency
- Output voltage (ignition- and standard pulses):
 - 1200V_{ss} at primary winding of output transformer
- Pulse frequency: 5000..80000Hz
- Ignition frequency: 250Hz to max. ½ of pulse frequency, sequence stored in EEPROM
- Automatic functions: Frequency and ignition pulse energy
- Status information
 - ignition performed
 - module overload

8.4 Signal shapes

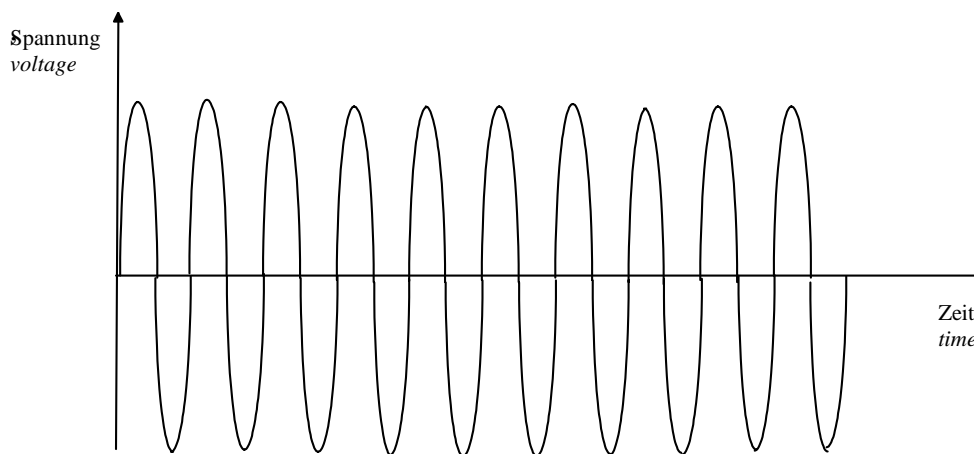

This signal-shape is used for the function Soft-coagulation in steps 1-5.

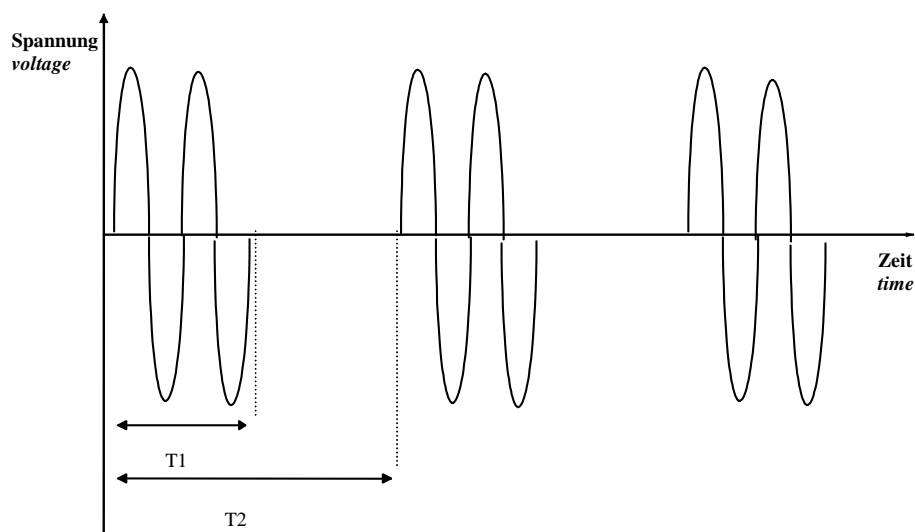

RF-current (pulsed Sinus signal, duty circle 1/4) with periodically damped amplitude

This signal-shape is used for the function Force-coagulation in steps 1-5.

¹ not valid for A-3000/ -2000
² not valid for Arco-2000

³ not valid for MBC600
⁴ not valid for Arco-1000

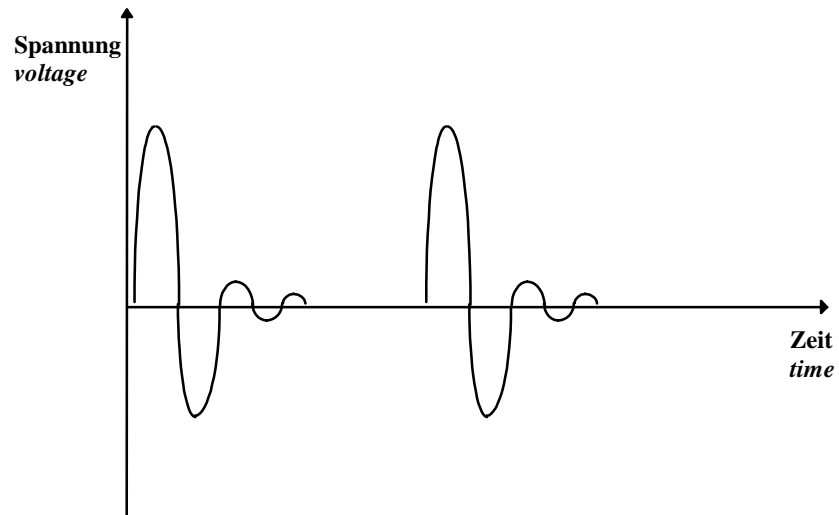

RF-Current of fulguration

This signal-shape is used for the function Spray-coagulation in steps 1-5.

¹ not valid for A-3000/ -2000
² not valid for Arco-2000

³ not valid for MBC600
⁴ not valid for Arco-1000

Block diagram Coagulation module (fig 8.1)

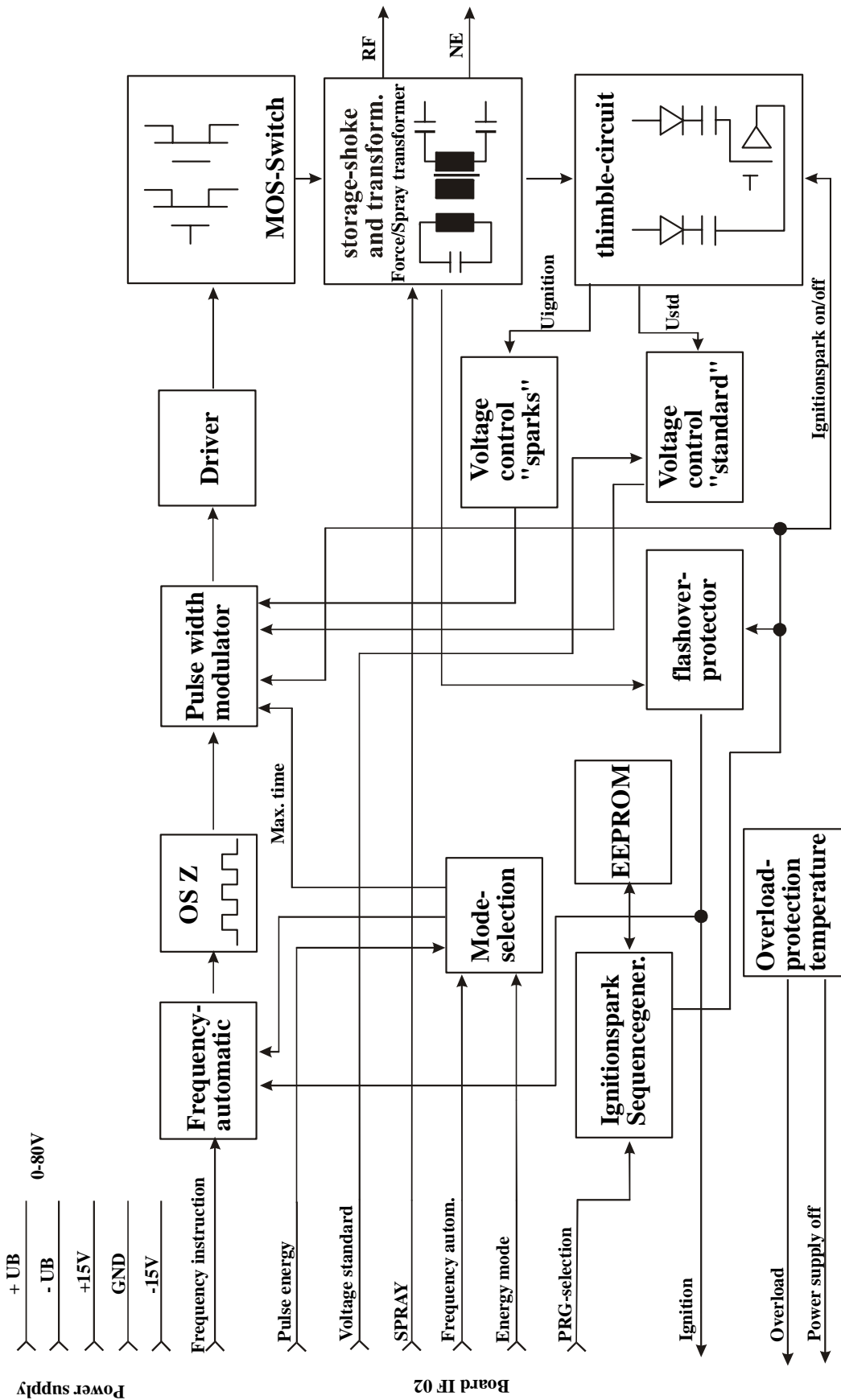

¹ not valid for A-3000/ -2000
² not valid for Arco-2000

³ not valid for MBC600
⁴ not valid for Arco-1000

9. Description of handpiece recognition

Purpose of HSE04 is to recognize the different connected handpieces and bipolar tweezers, to recognize activation of a push-button (finger switch, foot switch) with galvanic isolation and to transfer the corresponding signals to the CPU.

9.1. Properties

- Supply: $\pm 15V$, GNDA, +5V, GND
- Output signals: I^2C -bus (A/D-converter)
-4 bit (4 step window discriminator)
- Connections: -1 coded tweezers
-2 foot switches
-2 coded handpieces
or 1 coded handpiece (equipment version 2)
Equipment version 2*: A coded handpiece for a different application can be recognized by additional wiring.

9.2. Function

An oscillator generates a narrow pulsed AC-interrogation signal with a frequency of approx. 22 kHz and approx. 16V_{ss}. The following final stage amplifies this signal and feeds the primary of a transformer from the transformer array (Transformers 1 to 7).

Transformer 1, 2	Handpiece 1 / connector J1 resp. J5*
Transformer 3, 4	Handpiece 2 / connector J2 resp. J5*
Transformer 1, 2, 3	Recognition for other applications
Transformer 5	Bipolar tweezers / connector J3
Transformer 6	Foot switch 1 / connector J8 and J9
Transformer 7	Foot switch 2 / connector J8 and J9

For an interrogation the CPU switches by means of a decoder and a switch array the primary of a transformer from the transformer array to the final stage of the oscillator. By the coding of the handpiece (respectively by pressing the finger switch of a handpiece) which is connected to the secondary of the selected transformer, a characteristic recognition signal is generated at the primary. This signal is rectified and fed to the level adaptation circuit (0V to 4V).

The adapted recognition signal switches the output level of the comparator in the following window discriminator and is transformed into digital form by an A/D-converter (I^2C chip). Now these signals can be evaluated by the CPU.

The foot switch interrogation is performed in the same way as for the finger switches.

¹ not valid for A-3000/ -2000
² not valid for Arco-2000

³ not valid for MBC600
⁴ not valid for Arco-1000

Block diagram Handpiece recognition board

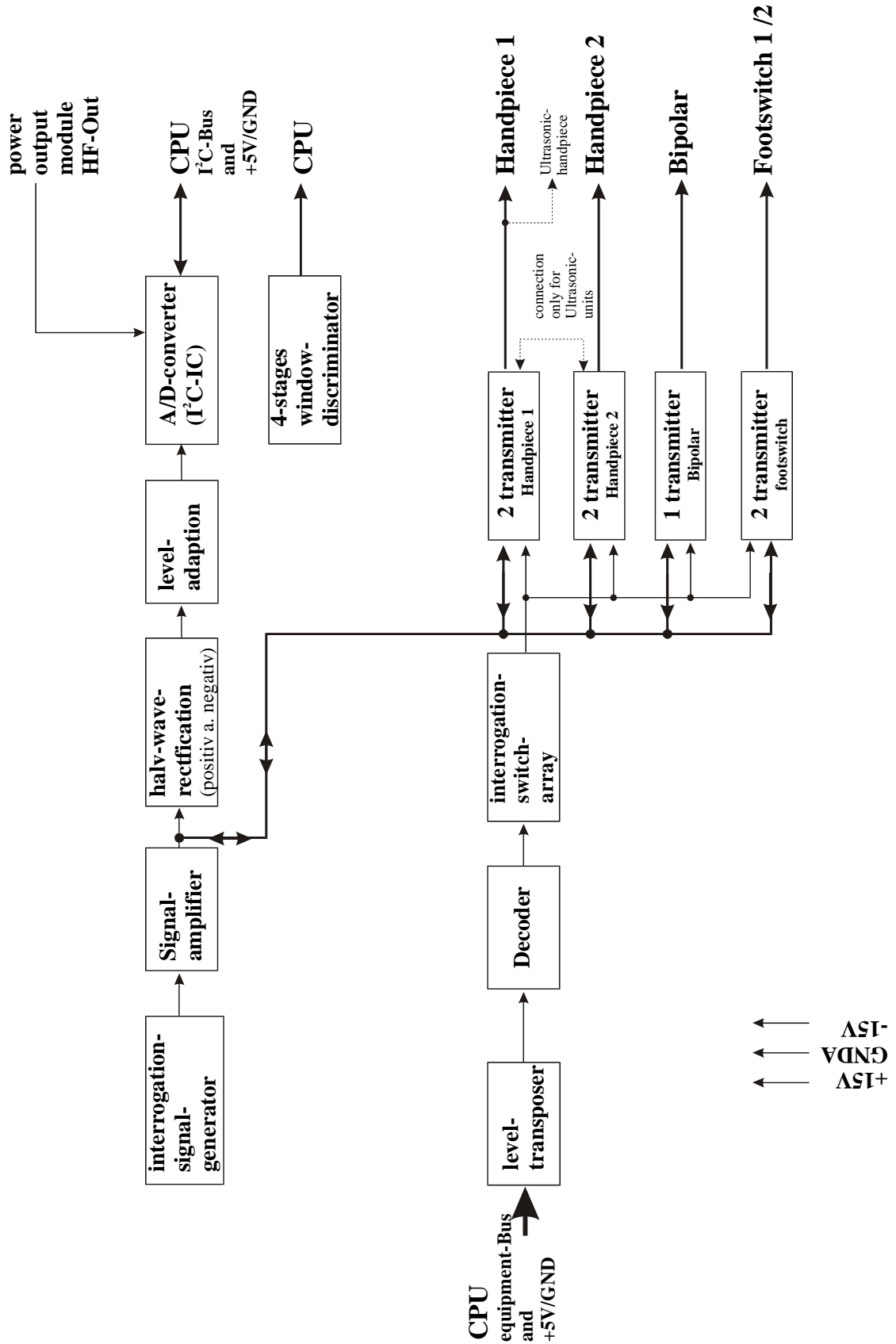

¹ not valid for A-3000/ -2000
² not valid for Arco-2000

³ not valid for MBC600
⁴ not valid for Arco-1000

10. Description of interface board

The interface board serves for the data communication between CPU and the module. It is part of the coagulator- and the cut module, each of them contain this board.

Electrical properties:

Voltage supply:	± 15 Volt, 0 Volt (GNDA) +5 Volt, 0 Volt (GND)
Data input: (Connector J1)	12 bit
Data output: (Connector J2)	6 analog outputs 8 bit (digital)
Data back-transfer:	2-bit module back-transfer signal, DOWN-signal for high Power supply (connector J2 & J3) to module status bus

Via connector J1 and the optically isolated module control-bus driver the interface board receives module control data and address data from the CPU. The module control data appearing at the output of the opto-coupler array are stored in the intermediate memory-1, after intermediate memory-1 has received the clock signal (strobe) from the decoder.

In the following the CPU transmits address data to the interface board. These address data determine by chip selector and address comparator which of the following units (D/A-converter 1/2/3/4/5/6 or intermediate memory-2) has to take the data from intermediate memory-1.

The stored data are transferred to the module via the module connection (connector J2), which supplies the interface board with power. The module sends a back-message to the CPU via J2 and J3.

¹ not valid for A-3000/ -2000
² not valid for Arco-2000

³ not valid for MBC600
⁴ not valid for Arco-1000

Block diagram Interfaceboard

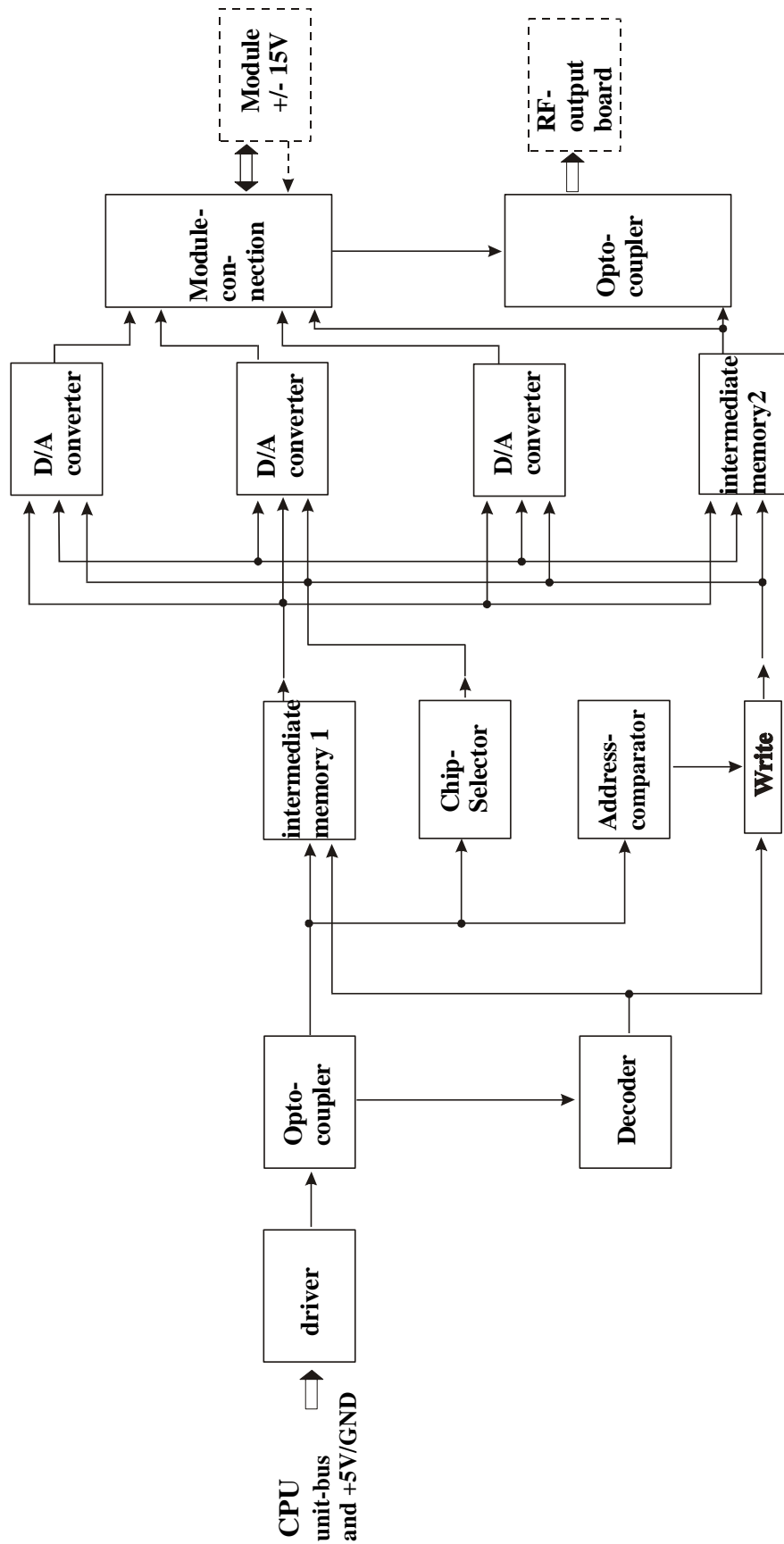

¹ not valid for A-3000/ -2000
² not valid for Arco-2000

³ not valid for MBC600
⁴ not valid for Arco-1000

11. Description of gas-system¹

11.1. External gas-system

The pressure regulator of the gas bottle (2-step pressure reducer) reduces the bottle pressure to the equipment input pressure of 8 bar. In order to make connections of regulator to gas bottle and from regulator to equipment easy, all connections are equipped with a quick-lock system. It is only necessary to tighten the regulator by hand. After opening the gas-bottle the regulator is tightly locked to the outlet valve of the gas-bottle. Additionally the regulator is equipped with a bleed-valve to let out the rest-pressure after closing the bottle-valve. This allows an easy removal of the regulator from the bottle (Exchange of gas-bottle). The hose connection between regulator and equipment is simply done by plugging the gas-hose into the quick-locks.

11.2. Internal gas system (gas control unit and gas control board)

11.2.1. General description

The gas control unit serves for regulation and monitoring of Argon gas-flow with Argon handpieces.

11.2.2. Principle of operation

The gas, adjusted to constant pressure by the pressure regulator, flows through a proportional valve. Then the gas passes a throttle (flow resistance) and reaches the tube of the handpiece via a filter. A pressure transducer measures the pressure before and after the throttle. The pressure difference is an indication for gas flow. On deviations from desired gas flow the error is corrected by a changed control of the proportional valve. As the pressure difference is proportional to the square of gas flow (volume flow), resulting in very small values at small gas flows, two additional throttles can be inserted between the pressure transducer by means of two magnetic valves. This makes three gas flow control ranges. Check of gas flow is performed by the second pressure transducer (at the output). If a maximum pre-selected pressure is exceeded, usually caused by an obstruction of the handpiece-tube, this error will be recognized.

11.2.3. Design of gas control unit

Fig. 11.1 shows the general design of the gas control unit.

The gas control unit consists of the following components:

- 1 pressure regulator, keeps input pressure constant.
- 2 pressure switches, check for input pressure.
- 3 proportional valve (flow control).
- 4, 5 pressure transducers, measurement of pressure difference
- 6, 7 Magnetic valves for switching throttles (ranges for regulation)
- 8,9 Throttles (flow resistances)
- 10 fine-filter (removes contaminations)

All components are mounted onto an aluminum block and interconnected.

11.2.4. Technical data

- Gas flow: 0.1 to 8 l/min in three ranges
- Input pressure 6 to 10 bar
- Output pressure max. 3 bar
- flow monitoring by pressure sensors
- precision $\pm 20\%$ from 0.1 to 8 l/min
(precision depends on software used)

¹ not valid for A-3000/ -2000
² not valid for Arco-2000

³ not valid for MBC600
⁴ not valid for Arco-1000

Block diagram Gasunit (fig. 11.1)

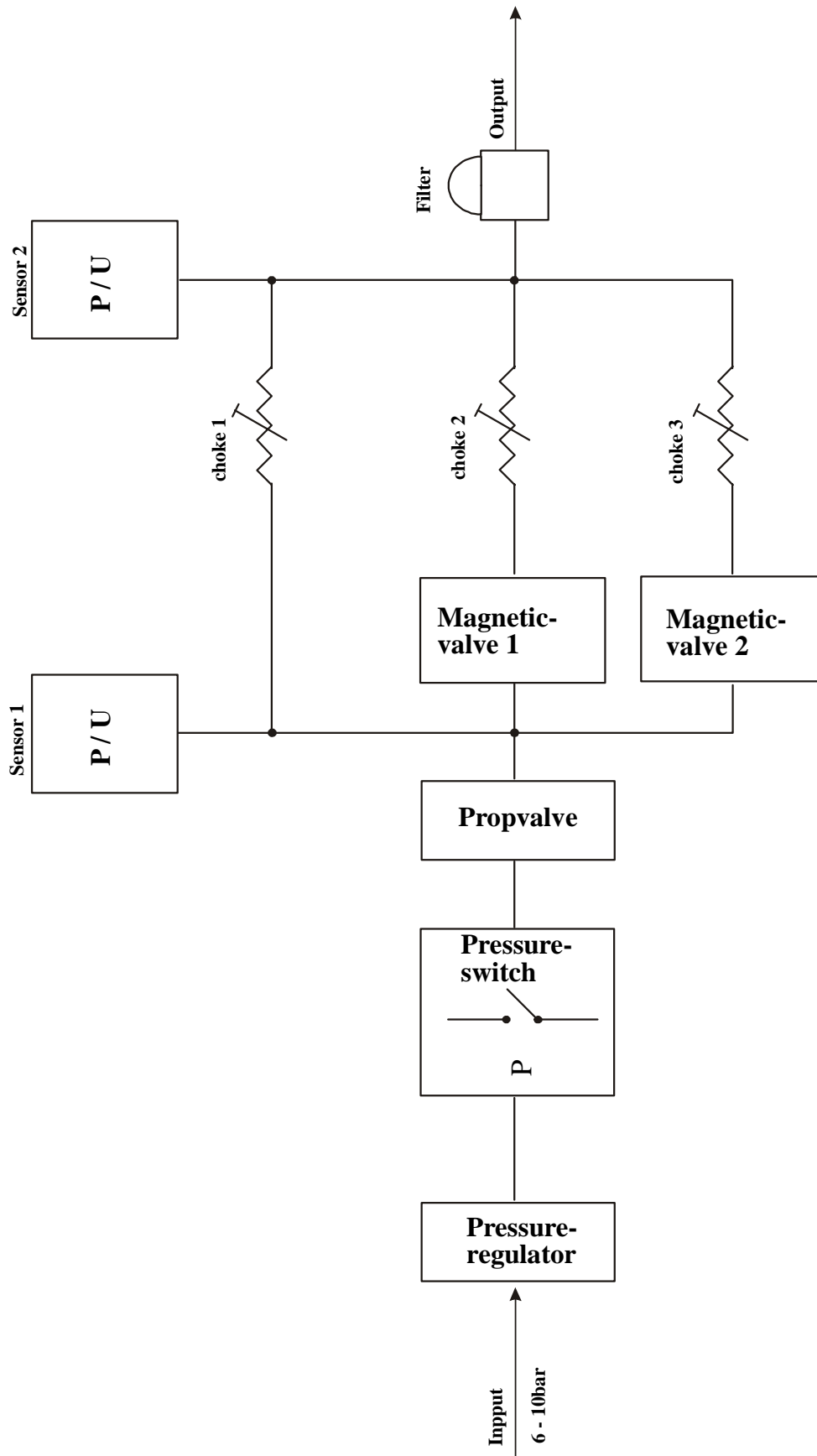

¹ not valid for A-3000/ -2000
² not valid for Arco-2000

³ not valid for MBC600
⁴ not valid for Arco-1000

11.3. Description of gas control board

11.3.1. General description of gas control board

The gas control board serves for control of the proportional valve and the magnetic valves on the gas unit. Furthermore the signals of both pressure transducers and the pressure switch are processed, digitally converted, and transferred to the CPU by a I²C-bus.

11.3.2. Description of gas control board

Fig 11.2 shows the block diagram of the gas control board.

The signals of the pressure sensors and the pressure switch of the gas unit go through the measuring amplifiers and signal conditioning to the I²C-bus interface. The electrical feeding of the sensors is also done by the gas control board. A conversion of analogue to digital measurement values is performed in the I²C-bus interface. These values are transferred to the CPU for evaluation. The proportional valve as well as the magnetic valves are controlled by the CPU via the bi-directional I²C-bus. A pulse width modulator, controlled by the analogue to digital converter of the I²C-bus interface, feeds the proportional valve with a rectangular signal of variable pulse width. This procedure reduces hysteresis effects of the proportional valve, which otherwise could cause oscillations during regulation. The power supply is ±15v.

¹ not valid for A-3000/ -2000
² not valid for Arco-2000

³ not valid for MBC600
⁴ not valid for Arco-1000

Block diagram gas control board (fig. 11.2)

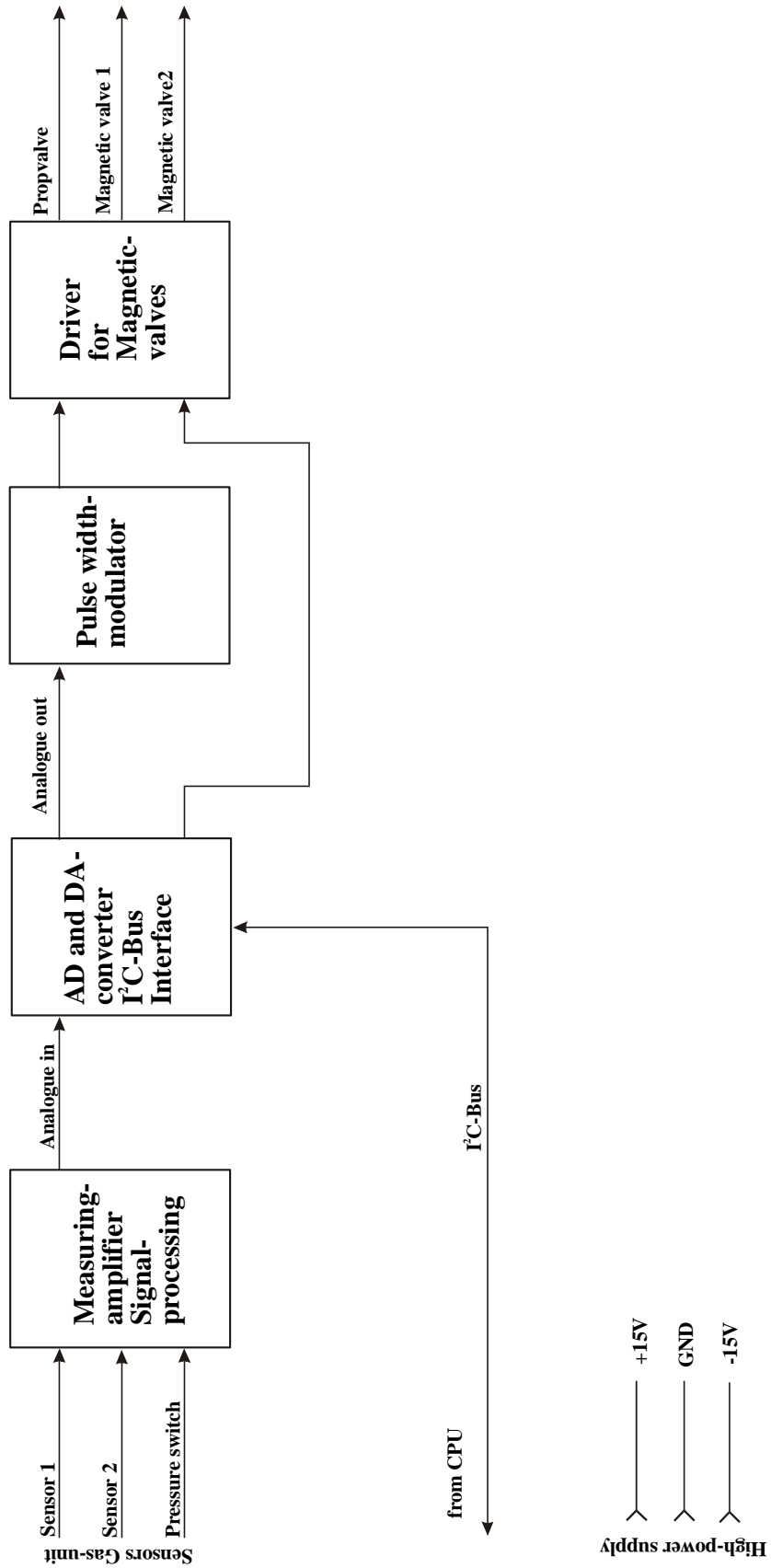

¹ not valid for A-3000/ -2000
² not valid for Arco-2000

³ not valid for MBC600
⁴ not valid for Arco-1000

12. Service- and adjustment procedures

This chapter is intended to support the trained service technician in case of repair, for troubleshooting and for calibration. It shall be stated once more that:

Modifications and repairs on this equipment must only be performed by the manufacturer or by persons authorized by him. If non-authorized persons perform modifications or repair on this equipment or its accessories the manufacturer undertakes no liability. Furthermore the warranty expires in this case.

Most adjustments of the equipment can be done within the Service-mode. For these adjustments it is not necessary to open the equipment. The adjustments are performed with the keyboard on the front panel.

An adjustment of modules inside the equipment shall be carried out only in exceptional cases because the potentiometers are sealed after adjustment and de-adjustment is nearly impossible. After every adjustment the potentiometers are again sealed with securing lacquer.

The LEDs inside the equipment are for functional checks and allow easy troubleshooting.

After switching-on the equipment, the micro-controller first checks all operational parameters necessary for error-free operation. If the self-test detects deviations from the given specifications, an error-code is displayed on the front panel and the use of the equipment is inhibited. In order to start the equipment nonetheless, service mode has to be started by pressing the button "Cut step 1" during switch-on (see below). **This is only allowed for service purposes!** The meanings of the error-codes are given in the chapter "Error indication at system start".

12.1. Description of LEDs and adjustment potentiometers

The following plans show the placements of potentiometers and LEDs. The function of the potentiometers is described in more detail in connection with the adjustment procedures of the different modules. The meanings of the LEDs for function-check of the equipment are as follows:

High-power supply

D23 Current limiting:	Lights up, if maximum output current is exceeded (e.g. short-circuit of Cut-module)
D27 :	Mains voltage outside the allowable values (230v ±15%)
P2	Current limiting
P3	Voltage adjustment (100V)

¹ not valid for A-3000/ -2000
² not valid for Arco-2000

³ not valid for MBC600
⁴ not valid for Arco-1000

Coagulator module

D10	arc recognized
D11	spray-mode (always lights when module starts)
D28	working impulse voltage reached
D29	ignition voltage reached
D56	module overloaded (not in use yet)
P1	Output power (working pulse energy)
P2	Ignition pulse energy
P3	arc detection

Cut module

D14	bipolar mode
D31	arc regulation
D47	power limiting
D50	current limiting
P2	offset power measurement
P3	resonance frequency adjustment bipolar
P4	resonance frequency adjustment monopolar

Handpiece recognition board

D59	interrogation from CPU (must blink periodically)
-----	--

RF-Output Module (HFO), Piggyback board

P1	adjustment of Offset-power test amplifier (Offset-voltage)
----	--

CPU

D1 Idle LED	(yellow) shows working of CPU by flickering
D2 Seri LED	red (always on)

¹ not valid for A-3000/ -2000
² not valid for Arco-2000

³ not valid for MBC600
⁴ not valid for Arco-1000

Arrangement of LEDs and potentiometers I

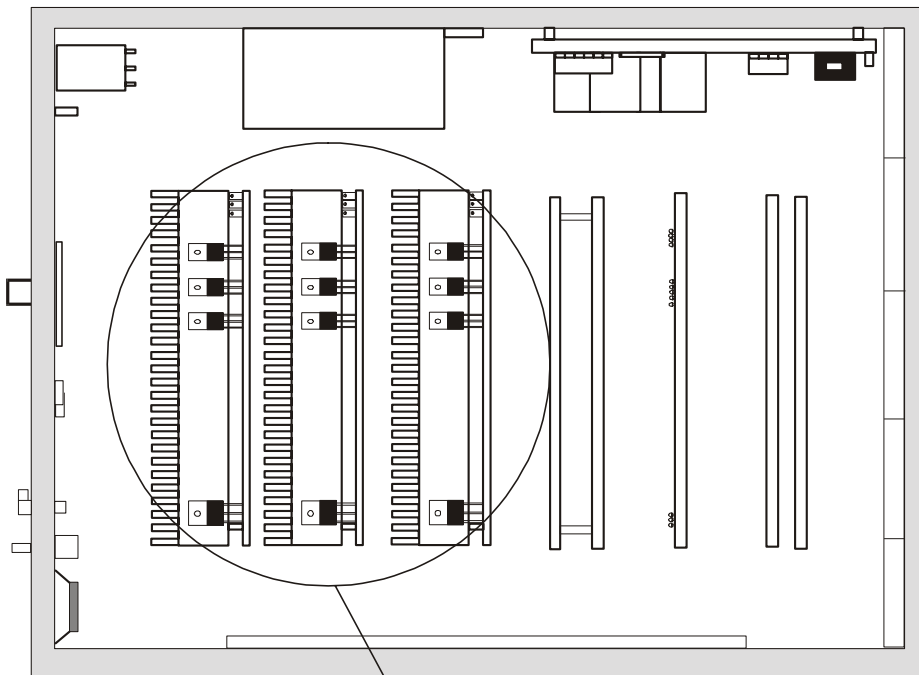

Open case is an Arco-3000, placement of the boards is different in other units, placement of potentiometer is the same

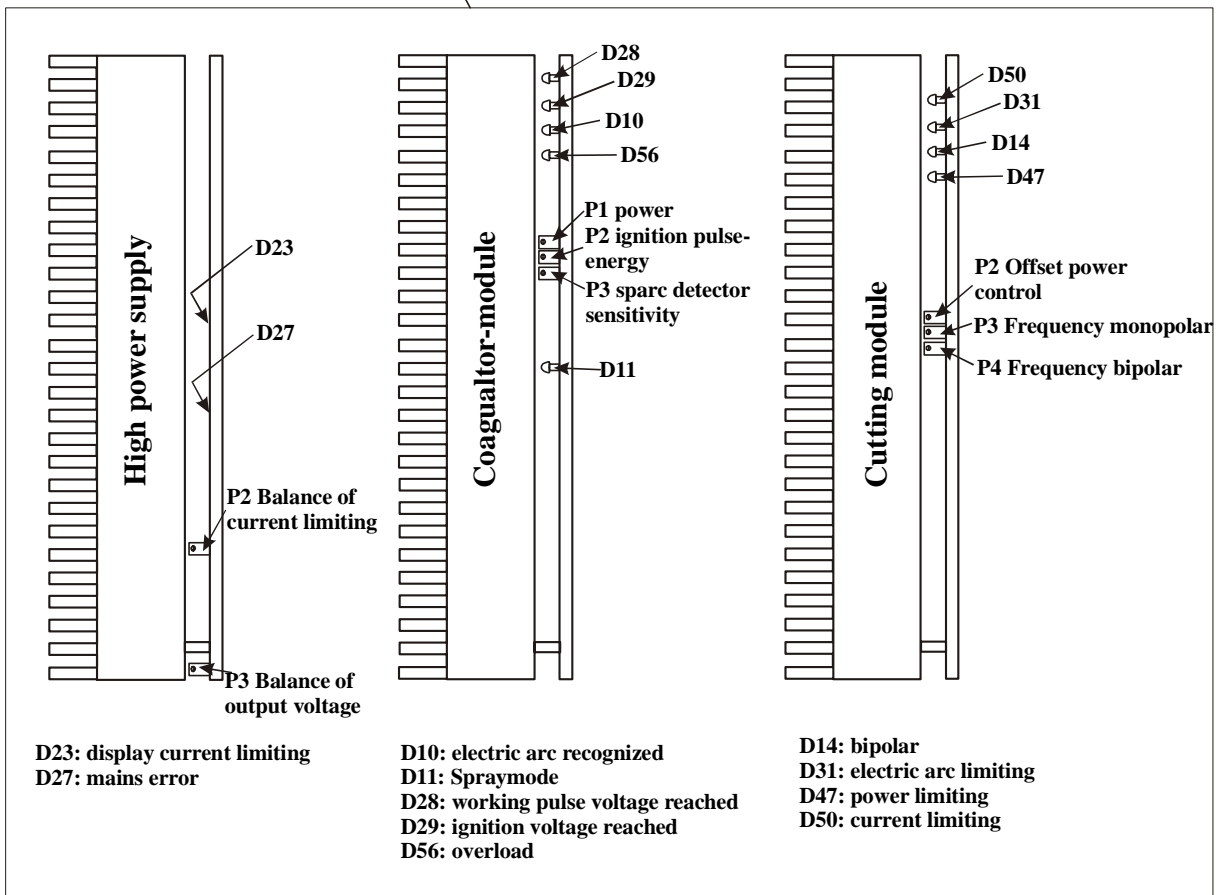

¹ not valid for A-3000/ -2000
² not valid for Arco-2000

³ not valid for MBC600
⁴ not valid for Arco-1000

Arrangement of LEDs and potentiometers II

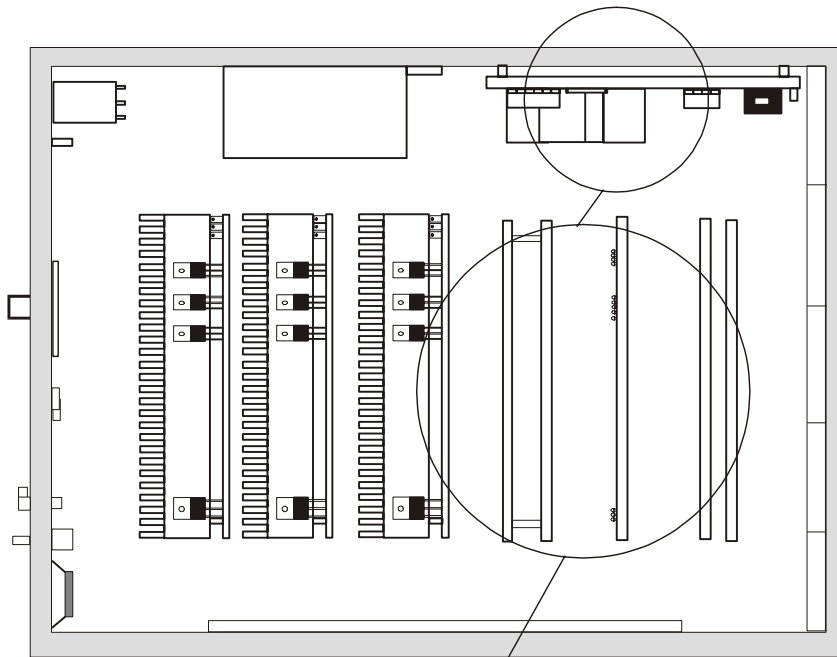

Open case is an Arco-3000, placement of the boards is different in other units, placement of potentiometer is the same

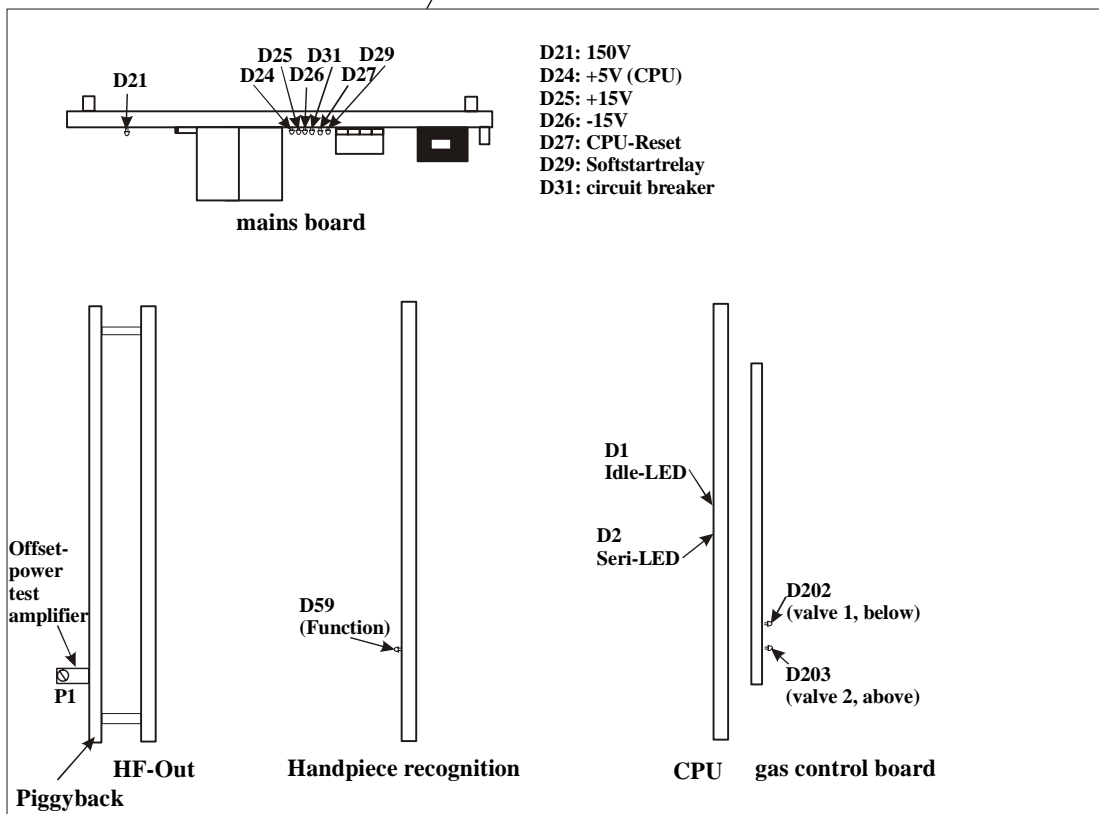

¹ not valid for A-3000/ -2000
² not valid for Arco-2000

³ not valid for MBC600
⁴ not valid for Arco-1000

12.2. Error indication at system start

On start of the system a self-test is performed, which checks various power supply parameters for correct function. If an error is detected, the error code is shown in the very left 7-segment display. The indication is divided into the function group (e.g.:1) and the function (e.g.:2), divided by a decimal point. The exact explanation of the error codes is given on pages 70pp.

12.3. Configuration of important bus cables and connectors

In the following table of pin configuration "top" refers to the opened bottom plate (construction state of the equipment), sighting is from the front panel. For flat cables with mica plugs the brown wire (with colored cables) respectively the red wire (with gray cables) is pin 1. The counting of pins goes from top to bottom respectively from left to right.

Bus cable / plug	connects	Pin description	Remarks
High power supply Plug J1	Transformer	1 18V~ 2 3 18V~ 4 5 16V~ 6	18/18/ 16V~ (vertical, right)
Plug J2	Power supply board	1 Relay 2 Relay 3 + 150V= 4 -	Feeding high power supply Soft start relay (vertical, right)
Supply bus	High power supply Coag module Cut module	1 + 0 - 100 V 2 Ø 3 +15 V 4 Ø 5 - 15 V	Supply modules (vertical, right) Mascon-plug
Module control bus (MSB)	High power supply Coag module Cut module CPU	1-12: Data 13: 0V 14: 5V	Control of power modules (left of Power supply) (right other modules)
Module status bus	High power supply Coag module Cut module RF-output module	Pin 1: 0V Pin 2: U Pin 3: I Pin 4: 0V Pin 5: DOWN Pin 6-8: Status	transmission current / voltage of power supply Report of module status (position as for MSB)
Coagulator module Plug J7	RF-output module	1: RF 2: RF	left at module, to right for RF-output module

¹ not valid for A-3000/ -2000
² not valid for Arco-2000

³ not valid for MBC600
⁴ not valid for Arco-1000

Cut module Plug J1	RF-output module	1: RF 2: RF	left at module, to the right between cooling body to RF-outp.mod.
RF-output module Plug J1	RF-modules	1: RF (coag module) 2: RF (not connected) 3: RF (coag module) 4: RF (cut module) 5: RF (cut module)	right bottom
RF-output module Plug J2 Plug J3 Plug J4 J5 J6	Test resistor Bipolar connection PE-connection Socket Argon Socket monopolar	2-pole 2-pole 2-pole 1-pole, pin at side as J5	right over J1 middle top left bottom middle left top left
Handpiece recognition J1 J2 J3 J8, J9 J7 (power supply +5V, +15V, -15V) J13 J14 J16 (I ² C connection)	Socket monopolar Socket Argon Socket bipolar Foot switch sockets RF-output module CPU Power supply board CPU (handpiece bus) CPU (I ² C bus) RF-output module	8-pole MICA 8-pole MICA 4-pole MICA 8-pole MICA 5-pole Mascon 1, 2 = GND +5V 3, 4 = -15V GND 4,5 = GND +15V 20-pole MICA 14-pole MICA 8-pole MICA	middle left bottom left top left top right equal val. top middle pins from the front left to right top right beside J3 top right of J13 top right of J14
CPU board J1 J2 (status bus) J3 J5 (mod. control bus) J6 (HSE bus) J7 (I ² C-bus) J4 (power supply +5V, +15V, -15V)	Loudspeaker RF output module not connected! Cut- coag module and high power supply Handpiece recognition Handpiece recognition and front p., gas contr Power supply board Handpiece recognition RF output module.	4-pole RIA 14-pole MICA 14-pole MICA 14-pole MICA 20-pole MICA 14-pole MICA 5-pole Mascon	at the side left top right vertical top right right below J3 top left right of J6 top middle right
Gas control board J1 (I ² C-bus) J2 (+/- 15V) J3 J4 J5	CPU from CPU Sensors gas pressure Sensor voltage +/-15V Gas pressure switch Valves	14-pole MICA 3-pole RIA 1 = +15V, 2 = GND 3 = -15V 6-pole RIA 123=+/GND/-Sens. A 456=+/GND/-Sens. B 2-pole RIA 6-pole RIA 1-2 prop. Valve 3-4 valve 2 5-6 valve 1	bottom between J3 and J4 right of J2 left of J2 left

¹ not valid for A-3000/ -2000
² not valid for Arco-2000

³ not valid for MBC600
⁴ not valid for Arco-1000

Power supply board J6 J7	Mains switch Transformer primary	2-pole RIA 4-pole RIA 1-2, 3-4 primary wdg.	top right at the side top right
J1	Transformer second.	5-pole RIA 1-2 18V~, 4-5 21V~	bottom left
J8	Rectifier	2-pole RIA 1-2 -/+150V	top right
J9	High power supply	4-pole RIA 1-2 relay, 3-4 +/-150V	top left, vertical
J2 (Power supply)	CPU, front panel, Handpiece board RF-output module	8-pole RIA 1-2 GND/+5V 3-4 -15V/GND 4-5 GND/+15V 6 not connected 7-8 GND/+5V	bottom right
J5 (microprocessor monitoring)	Front panel	6-pole MICA	right over J2
Front panel MG_PM1 J6 J7 (I ² C-bus) J1 (I ² C-bus, contin.) J5 (microprocessor monitoring)	not connected CPU other panel boards Power supply board	14-pole MICA 14-pole MICA 8-pole MICA 8-pole MICA	top horizontal horizontal below J6 vertical beside J7 horizontal beside J6

12.4. Service mode

The service mode is used for adjustment of the equipment and for obtaining information out of it. Furthermore the equipment can even be started if the self test fails. In this mode the safety functions (self test) are disabled and an application of the equipment at the patient is not allowed.

12.4.1. Preparation of service mode

-ARCO 1000:

--Press button Argon step 1, switch on equipment and wait until display lights up.

-other types:

--Press Cut step 1, switch on equipment and wait until display lights up.

The equipment starts without performing the self test. All functions are available as usual.

12.4.2 Switching to service mode

The service mode must be prepared (see above).

-Arco 1000

--Press button Argon step 1 and button Purge simultaneously

other types

--Press Cut step 1 and Coagulation step 1 simultaneously.

Repetition brings the equipment back into working mode.

An application at the patient is only allowed after a restart (Switching the equipment off and on).

¹ not valid for A-3000/ -2000

² not valid for Arco-2000

³ not valid for MBC600

⁴ not valid for Arco-1000

12.4.3. Selecting service functions

It is possible to select a main function with included sub-functions. The procedure is different for ARCO 1000 and the other types. In general it has to be distinguished between a service function and the sub-functions belonging to this function. The sub-function can only be selected after the main function is selected. The required parameters for adjustment are set and must be stored. The stored parameters are placed in a non-volatile memory and are effective after leaving the service mode.

-ARCO 1000

- Select main function with the keys Argon 5 (increase function number) and Argon 4 (decrease function number).*
- Select appropriate sub-function by means of power selector (up) or (down). (indication: Main function.Sub-function in the power indicator)*
- Increase or decrease parameters with the gas flow selector (up/down).The gas flow indicator shows the actual parameter. (In service function "0" the software version is displayed).*
- Store the adjusted parameter by pressing the Argon 3 key. This is confirmed by a confirmation tone.*

-other types

- Select main function with the keys Cut 5 (increase function number) or Cut 4 (decrease function number).*
- Select appropriate sub-function by means of Cut power selector (up) or (down). (indication: Main function.Sub-function in the Cut power indicator)*
- Increase or decrease parameters with the Coag power selector(up/down).The Coag power indicator shows the actual parameter. (In service function "0" the software version is displayed).*
- Store the adjusted parameter by pressing the Cut 3 key. This is confirmed by a confirmation tone.*

The parameters are displayed in hexadecimal.

¹ not valid for A-3000/ -2000
² not valid for Arco-2000

³ not valid for MBC600
⁴ not valid for Arco-1000

12.4.4. Description of service functions

List of service functions

Service-mode	Sub-function	Description	Remarks/Indication
0	1-3	Basic settings / check of gas system	Disp. Software version
1	1-2	Loudness of operational signal	
2	1-3	Autostop times bipolar/monopolar/gas	
3	1-5	Gas flow ICS and handpieces	
4	1-3	RF-output delay Argon coagulation	default value!
5	1-3, 4.5	Adjustment of PE-recognition bipolar recognition	
6	1-2	Bipolar start delay time, min frequency	
7	1-5	Gas flow for VICS handpieces	
8	1-5	Gas flow for 2.5mm probe and MICS-handpieces	
9	1-5	Gas flow for 1.6mm probe	
10	1-5	Gas flow MFS handpiece	
11	1-2	Adjustment resonant frequencies cut module	Power supply. Volt. 30V
12	1	Cut module offset power regulation	Power supply. Volt. 0V
13	1-3	Cut module, power calibration	Output power
14	1-5	Test of power monitoring	Power indication
15	1-4	Display power supply voltage (1), power supply current (2), Offset power test amplifier, part a (3), Offset power test amplifier, part b (4)	-hexadecimal value, -15-3, -4 for adjustment of HFO_B2 board

12.4.5. Performing service adjustments

12.4.5.1. Checking and adjusting basic settings of gas system (Service function 0)

- Operate system with ICS handpiece, gas bottle must be connected.
- Select service function 0 (Software version is displayed)
- The following gas flow values must be achieved:
 - Sub-function 1: 1.5 to 2.0 l/min
 - Sub-function 2: 4.0 to 5 l/min
 - Sub function 3: 9.0 to 11.0 l/min

In case of deviations the reduction valves 1 to 3 of the gas system must be readjusted and the gas flow has to be rechecked.

12.4.5.2. RF-output signal delay Argon coagulation (from SM 4.3 gas flow adjustment) (Service function 4)

The time from start of gas flow to the start of the RF-generator is adjusted.

- Select service function 4.1, set 32Hex
- Select service function 4.2, set 30Hex
- Select service function 4.3 adjust "Cut" gas value to 0,2l/min (s. e.g. SF3)

12.4.5.3. Start delay bipolar / Resonance frequency bipolar recognition (Service function 6)

- Select service function 6 with sub-function 1
- Adjust display (parameter) to 14Hex (0.2 sec). One digit equals 10 msec.
- Select service function 6 with sub-function 2 and press CUT 3. The actual resonance frequency is stored.

¹ not valid for A-3000/ -2000
² not valid for Arco-2000

³ not valid for MBC600
⁴ not valid for Arco-1000

12.4.5.4. Adjustment of gas flow (Service functions 3,7,8,9,10)

With this service function the gas flow for different types of handpieces and probes is adjusted. For this purpose the service function corresponding to the handpiece or probe has to be selected and the gas flows (Sub-functions 1 to 5) have to be checked or adjusted according to the table below. It has to be considered that the handpieces deliver power. A patient electrode must be connected.

The following table shows gas flows, handpiece types and service functions.

Service function	Handpiece	Sub-function	Gas flow	Remarks
3	IC/S; VIC/S	1	2.0 l/min	
3	IC/S; VIC/S	2	3.0 l/min	
3	IC/S; VIC/S	3	4.0 l/min	
3	IC/S; VIC/S	4	5.5 l/min	
3	IC/S; VIC/S	5	7.0 l/min	
4	ENT	3	0,2 l/min	
7	open, coded	1	1.0 l/min	
7	open, coded	2	1.5 l/min	
7	open, coded	3	2.0 l/min	
7	open, coded	4	2.5 l/min	
7	open, coded	5	3.5 l/min	
8	Argo-Flex/-Troc	1	0.5 l/min	
8	Argo-Flex/-Troc	2	1.0 l/min	
8	Argo-Flex/-Troc	3	1.5 l/min	
8	Argo-Flex/-Troc	4	2.0 l/min	
8	Argo-Flex/-Troc	5	2.5 l/min	
9	Broncho-probe	1	0.2 l/min	
9	Broncho-probe	2	0.4 l/min	
9	Broncho-probe	3	0.5 l/min	
9	Broncho-probe	4	0.8 l/min	
9	Broncho-probe	5	1.0 l/min	
10	MFS	1	2.0 l/min	like ICS
10	MFS	2	3.0 l/min	
10	MFS	3	4.0 l/min	
10	MFS	4	5.5 l/min	
10	MFS	5	7.0 l/min	

For these measurements a gas flow meter, calibrated for argon gas, and with a measuring range from 0.2 to 10 l/min has to be used, which is connected to the handpiece by means of a soft hose.

¹ not valid for A-3000/ -2000
² not valid for Arco-2000

³ not valid for MBC600
⁴ not valid for Arco-1000

12.4.5.5. Adjustment of patient electrode recognition (Service function 5)

This function sets the thresholds for the transfer resistance PE-electrode to patient. The PE-monitor recognizes four ranges for the transfer resistance:

-0 to 5 Ohm	PE-electrodes, undivided type	Indication yellow + green
-15 to 60 Ohm	PE transfer resistance good	Indication green
-75 to 95 Ohm	PE transfer resistance bad	Indication yellow
-more than 120 Ohm	PE transfer resistance insufficient	red, alarm

For the transition of states only the transition between two states is of interest. For adjustments the given adjustment resistors are connected and their value is transferred as a setup value by pressing CUT3 respectively GAS3 (Arco 1000).

Sub-function	Parameter adjustment	Adjustment resistor
1	Transition short circuit - good	10Ω
2	Transition good - bad	68Ω
3	Transition bad - open	100Ω
4	Lower impedance limit (bipolar)	150Ω
5	Upper impedance limit (bipolar)	1kΩ

The adjustment of bipolar recognition is done with a resistor of 150Ω in 5.4 and 1kΩ in 5.5, connected to the bipolar socket. The value is stored according to 5.1 - 5.3 with CUT3 (GAS3).

12.4.5.6. Auto stop times (Service function 2)

With this function the recommended auto stop times are set. One digit equals 10 msec, the indication is in hexadecimal. The following values are set:

Sub-function	Arco-types	MBC-types
1	32Hex (Argon)	64Hex (Handpiece 1)
2	64 Hex (Coag)	64Hex (Handpiece 2)
3	64Hex (Bipolar)	64Hex (Bipolar)

Remarks: 32Hex = 0.5 sec, 64Hex = 1 sec. If auto stop times are too long, they may be slightly reduced.

12.4.5.7. Service adjustments of Cut module (Service functions 11 and 12)

With these service functions the resonance frequencies for monopolar and bipolar operations can be adjusted. The cut module receives a fixed voltage. The power regulation is set to a fixed value of 150W.

Another service function switches off the power supply and sets the power selection to "zero". Now the offset of the measuring amplifier for power measurement can be adjusted.

-Service function 11

Resonance frequency monopolar & bipolar

-Service function 12

Offset adjustment of measuring amplifier for power measurement and check and adjustment of arc detection.

For further details see "adjustment of cut module".

¹ not valid for A-3000/ -2000
² not valid for Arco-2000

³ not valid for MBC600
⁴ not valid for Arco-1000

12.4.5.8. Calibration of cut module power (Service function 13)

If the power in cut mode during soft- and force coagulation is generally too high or too low, a calibration can be performed. This is done by choosing service mode 13, changing the parameter into the desired direction, leaving service mode and checking the cut power at 210W with 200 Ω load. Then enter service mode 13 again, readjust, if necessary, and store the parameter.

After service function 13.1 the fine adjustments for force and blend can be done with 13.2 and 13.3 in the same way as for 13.1.

Sub-function	Parameter adjustment	Power set
1	Cut mode, step 4	210W
2	Force, step 5	100W
3	Blend, step5	250W

12.4.5.9. Loudness adjustment (Service function 1)

-Min/Max loudness of volume control sub-function 1

--1Hex (recommended value)

--A0Hex (recommended value)

12.4.5.10. Check of power measurement (Service function 14)

This mode shows the delivered power in the parameter display decimal in Watts. A comparison with a RF-power meter informs about correct functioning. See also "Safety technical checks".

Sub-function	Calibration	selected power (W)
1	Cut-power low	40
2	Coag-power low	40
3	Cut-power high	210
4	Coag-power high	120
5	Cut-pulse-power high	40

Purpose of calibration is the adjustment of internal measuring circuits by means of externally measured values. This is done by connecting a power meter in position 200 Ω , setting Cut to 40W, and selecting step 14. On activation the measured power value is shown in the Coag display resp. Gas display (Arco 1000). A correction can be made by means of the arrow keys. Indicated and externally measured values should correspond. The calibration has to be performed for all sub-functions 14.1-5 as described above.

12.4.5.11. Indication power supply voltage and current (Service function 15)

The power supply voltage and the power supply current of the previously selected power step is indicated in hexadecimal.

- Sub-function 1: power supply voltage
- Sub-function 2: power supply current

¹ not valid for A-3000/ -2000
² not valid for Arco-2000

³ not valid for MBC600
⁴ not valid for Arco-1000

12.5. Service adjustments of the modules

Service adjustments have to be made at the following boards:

- High power supply
- Coagulator module (spray function)
- Cut module

12.5.1. Adjustment of high power supply

1. Necessary equipment

- Digital voltmeter

2. Adjustment

- Adjustment of output voltage
 - Set equipment to CUT step 5, 320W without blend and activate push button at handpiece. Adjust output voltage to 100V \pm 1V with potentiometer P3 (measurement at J3, pin 4 and 5 at the power supply). The handpiece is activated without load.
- Adjustment of current limiting
 - the current limiting has been precisely adjusted at the factory and shall only be readjusted, in case P2 has been turned inadvertently or if limiting is activated during RF-cutting although the module is intact and if the fuse on the mains relay board frequently blows.
 - measure voltage at pin 2 U8 to ground and adjust to -1.0V.

12.5.2. Adjustment of coagulator module

Remark:

- With equipment of Arco-series the pulse frequencies, which are of influence on the output power, are delivered from the synchro-board. Here, together with the coagulator module, first the frequencies and then the pulse rate have to be adjusted. For equipment of MBC-series (without a synchro-board) this does not apply.

Necessary equipment

- RF-power meter with load resistors of 100 and 200 Ω , measuring range up to 200W
m+i0um
Frequency meter, measuring range 0 to 100kHz (e.g. appropriate DMM)
- RF-Handpiece resp. argon handpiece for open surgery.

Adjustment procedure

Adjustment of synchro-board¹

- connect frequency meter to source and gate of T8 on coagulator module (T8 is the right big transistor on the board). Leave the power meter connected and select 200 Ω load.
- Select Argon step 1, start equipment and turn potentiometer P2 on synchro board for 14 \pm 0.5 kHz.
- Select Argon step 5 and set power selector to 120W. Start equipment and turn potentiometer P1 on synchro board for 70 \pm 2 kHz.
- synchro-pulses (15 kHz, 5 μ sec, 1V_{ss}) into BNC-socket (monitor signal)

¹ not valid for A-3000/ -2000
² not valid for Arco-2000

³ not valid for MBC600
⁴ not valid for Arco-1000

Turn potentiometer P3 on synchro-board and P3 on coagulator board fully counterclockwise. Select Spray or Argon step 1 and turn P3 (synchro-board) clockwise until LED D10 on coagulator board extinguishes. Turn P3 (synchro-board) one more turn. With this procedure the handpiece must not be connected to the power meter.

Remark: Output power and ignition pulse energy (see there) might be adjusted first without synchro-pulses.

Basic adjustment of output power (without synchro-pulses)

- Connect RF-meter (handpiece, patient electrode, casing and ground), load 200 Ω , select power step Spray 5 or Argon 5 and 120W. Start equipment and adjust potentiometer P1 for an output power of 120W at 200 Ω (without monitor signal).

Adjustment of ignition pulse energy

- Disconnect handpiece from RF-meter. Select power step Spray 1 or Argon 1 resp. 20W. Start equipment and adjust potentiometer P2 so that LED D29 just lights up. Then turn P2 one full turn counter-clockwise

Frequency check

Measurement by frequency measurement-device between source and gate of transistor T8. The following values have to be measured:

-Spray, 1: 20W 14 \pm 0,5kHz

-Spray, 5: 120W 70 \pm 5kHz

These frequencies are adjusted on the synchro-board: P2 (70 kHz) and P1 (14 kHz).

For types without a synchro-board the tolerances are larger because no adjustment is possible. The tolerances are 16 \pm 2kHz, 80 \pm 8kHz.

Adjustment of arc-detector sensitivity (Idle mode)

- Select power step Spray 1 or Argon 1, 20W. Operate handpiece without load. Turn potentiometer P3 fully clockwise. With running equipment turn P3 counterclockwise until LED D10 extinguishes. Turn P3 three full turns more counterclockwise.
- Test: With activation of Coag.-handpiece- or foot switch LED D10 lights up shortly and must extinguish immediately. This must also be the case when synchro-signals are applied to the synchro-board. If in this case D10 periodically blinks, P3 on the synchro-board must be turned clockwise until D10 extinguishes. Then turn this potentiometer one more turn clockwise.

Regarding position of potentiometers and LED's see "Position of LED's and Potentiometers I + II.

12.5.3. Adjustment of cut-module

Necessary equipment

- RF-power meter (load resistors 100, 200 & 300 Ω ; measuring range 350w)
- RF-Handpiece with switches
- Bipolar connecting cable
- Foot switch

The following adjustments have to be carried out:

- Resonance frequencies monopolar- and bipolar mode
- Adjustment offset voltage of power measuring amplifier
- Check of arc regulation

¹ not valid for A-3000/ -2000
² not valid for Arco-2000

³ not valid for MBC600
⁴ not valid for Arco-1000

Adjustment resonance frequency monopolar:

- Start equipment in service mode , select service function 11, connect RF-meter to monopolar handpiece with 100 Ω load, press handpiece switch "Cut" and adjust by means of P3 on cut module to maximum output power. Power approx. 85W.

Adjustment resonance frequency bipolar:

- connect bipolar connecting cable to RF-meter, select 100 Ω load, start the equipment (foot switch cut). Adjust by means of P4 to maximum output power. Power approx. 85W.

Adjustment offset of power measuring amplifier

- Select service function 12, sub-function 1 (Power supply delivers no voltage, selected power "zero", adjust potentiometer P2 so that LED D47 (cut module) just starts to light up. Press "Cut"-switch with this adjustment.

Check of arc regulation

- Select service function 12 (Power supply delivers no power, select appropriate parameters), connect signal generator (sine signal source resistance 50 Ω) to handpiece and PE-electrode. Set frequency to 1.05 MHz. Increase output voltage until LED D31 (cut module) just starts to light up. The required output voltage must be in the range 2 to 5V_{ss}. Press "Cut"-switch with this adjustment.

12.5.4 Adjustment of RF-Out B2 (SMD) [from SW 3.10]*Necessary equipment*

- RF-Handpiece with two fingerswitches
- Patient electrode

Adjustment of Offset-Voltage

- start unit in Service-Mode
- choose Service function 15, sub function 3
- Monopolar Handpiece and Patient electrode have already to be plugged in
- **Unit has to be switched on for at least 10 minutes already!**
- start unit periodically with handpiece button CUT (yellow) or Coag. (blue) (Only this way the offset-value will be displayed in the Coag.-field correctly).
- adjust with poentiometer P1 on HFO-B2 (piggyback) a value of 25-30
- Leave Service-Mode and start unit again

¹ not valid for A-3000/ -2000
² not valid for Arco-2000

³ not valid for MBC600
⁴ not valid for Arco-1000

13. Technical data

Mode⁴	power output at [Ω]	power range [W]	nominal frequency [kHz]	output voltage * [V_{PP}]
Cut 1	10W [200 Ω]	1W 70W	350	820
Cut 2	60W [200 Ω]	10W 130W	350	1160
Cut 3	130W [200 Ω]	70W 190W	350	1240
Cut 4	210W [200 Ω]	130W 250W	350	1290
Cut 5	320W [200 Ω]	190W 320W	350	1320
Blend 1	10W [200 Ω]	1W 60W	350	830
Blend 2	60W [200 Ω]	10W 110W	350	1160
Blend 3	120W [200 Ω]	60W 160W	350	1240
Blend 4	180W [200 Ω]	110W 210W	350	1280
Blend 5	250W [200 Ω]	160W 250W	350	1320
TUR1	10W [200 Ω]	1W 80W	350	940
TUR2	70W [200 Ω]	10W 150W	350	1250
TUR3	150W [200 Ω]	80W 220W	350	1320
TUR4	250W [200 Ω]	150W 290W	350	1320
TUR5	350W [200 Ω]	220W 350W	350	1320
Pulse1	7W [200 Ω]	1W 14W	350	1180
Pulse2	14W [200 Ω]	7W 21W	350	1250
Pulse3	22W [200 Ω]	14W 28W	350	1300
Pulse4	31W [200 Ω]	21W 35W	350	1320
Pulse5	40W [200 Ω]	28W 40W	350	1320
Soft 1	5W [200 Ω]	1W 30W	350	320
Soft 2	30W [200 Ω]	5W 55W	350	480
Soft 3	55W [200 Ω]	30W 80W	350	620
Soft 4	80W [200 Ω]	55W 100W	350	680
Soft 5	100W [200 Ω]	80W 100W	350	680

*) Output voltages are no-load values

¹ not valid for A-3000/ -2000
² not valid for Arco-2000

³ not valid for MBC600
⁴ not valid for Arco-1000

Mode⁴	power output at [Ω]	power range [W]		nominal frequency [kHz]	output voltage * [V_{PP}]
Force 1	5W [200 Ω]	1W	30W	**	860
Force 2	30W [200 Ω]	5W	55W	**	1150
Force 3	55W [200 Ω]	30W	80W	**	1300
Force 4	80W [200 Ω]	55W	120W	**	1320
Force 5 ***	120W [200 Ω]	80W	120W	**	1320
Spray 1	20W [200 Ω]	20W	40W	**	9000/4800
Spray 2	40W [200 Ω]	20W	60W	**	9000/4800
Spray 3	65W [200 Ω]	40W	80W	**	9000/4700
Spray 4	90W [200 Ω]	60W	100W	**	9000/5800
Spray 5	120W [200 Ω]	80W	120W	**	9000/5800
Argon 1 ¹	20W [200 Ω]	20W	40W	**	9000/4800
Argon 2 ¹	40W [200 Ω]	20W	60W	**	9000/4800
Argon 3 ¹	65W [200 Ω]	40W	80W	**	9000/4700
Argon 4 ¹	90W [200 Ω]	60W	100W	**	9000/5800
Argon 5 ¹	120W [200 Ω]	80W	120W	**	9000/5800
Argon 1 (2,5 probe & Argo- Troc) ¹	20W [200 Ω]	20W	35W	**	9000/4800
Argon 2 (2,5 probe & Argo- Troc) ¹	35W [200 Ω]	20W	50W	**	9000/4800
Argon 3 (2,5 probe & Argo- Troc) ¹	50W [200 Ω]	35W	65W	**	9000/4700
Argon 4 (2,5 probe & Argo- Troc) ¹	70W [200 Ω]	50W	80W	**	9000/5800
Argon 5 (2,5 probe & Argo- Troc) ¹	90W [200 Ω]	65W	90W	**	9000/5800
Argon 1 (1,6 probe) ¹	20W [200 Ω]	20W	30W	**	9000/4800
Argon 2 (1,6 probe) ¹	35W [200 Ω]	20W	40W	**	9000/4800
Argon 3 (1,6 probe) ¹	50W [200 Ω]	30W	50W	**	9000/4700
Argon 4 (1,6 probe) ¹	65W [200 Ω]	40W	60W	**	9000/5800
Argon 5 (1,6 probe) ¹	80W [200 Ω]	50W	80W	**	9000/5800
Bipo. Cut ^{2,3,4}	1 - 130W [200 Ω]	-	-	360	330 - 760
Bipo. Coag ^{2,3,4}	1 - 100W [100 Ω]	-	-	360	160 - 460

Ignition/Working voltage

*) Output voltages are no-load values

**) pulse-shaped signal

***) **ATTENTION: increased power only since software version 3.20. Older units might have lower power output**¹ not valid for A-3000/ -2000² not valid for Arco-2000³ not valid for MBC600⁴ not valid for Arco-1000

Signal shapes:

Cut ⁴	1-5	Continuous sine-wave
Blend ⁴	1-5	Pulsed sine-wave, duty cycle 80%
TUR ⁴	1-5	Continuous sine-wave
Pulse ⁴	1-5	Continuous sine-wave, pulsed
Soft ⁴	1-5	Continuous sine-wave
Force ⁴	1-5	Pulsed sine-wave, duty cycle 25%
Spray	1-5	similar to spikes (also for Argon-coag.)
Bipolar Cut ^{2,3,4}	1-130	Continuous sine-wave
Bipolar Coag ^{2,4}	1-100	Continuous sine-wave

Auto stop times

Auto:1.0 sec. for monopolar and bipolar coagulation

Auto:0.5 sec. for Argon coagulation

Technical gas data¹

Gas pressure 8 bar at equipment input

Gas flow rates in l/min (default):

	MFS	VICS/ICS	Probe adaptor open surgery	2.5mm probe & Argo-Troc	1.6mm probe	ENT-Coag (only 0,2l/min at Cut)
Argon 1	2.0 l/min	2.0 l/min	1.0 l/min	0.5 l/min	0.2 l/min	0.5 l/min
Argon 2	3.0 l/min	3.0 l/min	1.5 l/min	1.0 l/min	0.4 l/min	1.0 l/min
Argon 3	4.0 l/min	4.0 l/min	2.0 l/min	1.5 l/min	0.6 l/min	1.5 l/min
Argon 4	5.5 l/min	5.5 l/min	2.5 l/min	2.0 l/min	0.8 l/min	2.0 l/min
Argon 5	7.0 l/min	7.0 l/min	3.5 l/min	2.5 l/min	1.0 l/min	2.5 l/min

Gas shortage indication: for < 4.5 bar at gas connection

Gas blocking: Gas-pressure and -flow check at equipment output.

Error codes

Error codes are principally displayed on the leftmost 7-segment display. The indication is split up into the "function group" (e.g.:1) and the function (e.g.:2), divided by a decimal point.

Code	Description
1.1	External watchdog error
1.2	Internal watchdog error
2.1 - 2.6	Idle measurement faulty
3.1 - 3.3	Reference voltage error RF-output module
4.1 - 4.6	Offset error measuring amplifier RF-output module
5.1	Error on RF-output module
6.1 - 6.3	Error of power supply watchdog
7.1 - 7.8	Power supply voltage too high or too low
8.1 - 8.2	Handpiece recognition defective
9.1 - 9.4	Patient electrode recognition defective
10.1 - 10.8	Relay defective (RF-output module)
11.1 - 11.6	see 4.1 - 4.6
12.1 - 12.7	Cut module defective (wrong power)
13.1 - 13.5	Coag module defective (wrong power)

¹ not valid for A-3000/ -2000

² not valid for Arco-2000

³ not valid for MBC600

⁴ not valid for Arco-1000

For detailed description of error codes see following pages !!!

1.	Evaluation of test functions at start up
1.1	External watchdog defective
1.2	Internal watchdog defective
1.3	CRC check of EPROM showed errors
1.4	Patter-test of RAM failed; RAM defective
2.	Read-out of measuring channels without signal application at idle
2.1	Limits: min. 7 max. 12 Idle meas. Channel I80 (current of high power supply) outside of limits
2.2	Limits: min. 0 max. 11 Idle meas. Channel PWR_L (RF-output power) outside of limits
2.3	Limits: min. 0 max. 11 Idle meas. Channel B_REL_TST (test channel bipolar relay) outside of limits
2.4	Limits: min. 0 max. 12 Idle meas. Channel OSC_VAL (test channel oscillator) outside of limits
2.5	Limits: min. 7 max. 12 Idle meas. Channel B_M_VAL (Bipolar-monopolar-recognition) outside of limits
2.6	Limits: min. 0 max. 12 Idle meas. Channel NE_VAL (Meas. Channel PE-recognition) outside of limits
3.	Application of reference voltage on selected measurement channels
3.1	Limits: min. 173 max. 190 Measurement reference voltage I80, outside of limits
3.2	Limits: min. 147 max. 172 Measurement reference voltage PWR_L (RF-output power Low I ² C-ADC)
3.3	Limits: min. 147 max. 172 Measurement reference voltage B_M_VAL
4.	Determination of offset values in measuring channels with high precision
4.1	Limits: min. 0 max. 5 Offset determination I80
4.2	Limits: min. 0 max. 5 Offset determination U80 (Output voltage high power supply)
4.3	Limits: min. 1 max. 16 Offset determination PWR (RF-output power CPU-ADC)
4.4	Limits: min. 1 max. 83 Offset determination PWR_L (RF-output power Low I ² C-ADC)
4.5	Limits: min. 6 max. 57 Offset determination PWR_H (RF-output power High I ² C-ADC)
4.6	Limits: min. 0 max. 9 Offset determination HF_VOLT (RF-output voltage)
5.	Check of measuring oscillator
5.1	Limits: min. 166 max. 198 OSC_VAL outside of limits
6.	Test power supply watchdog
6.1	Limits: min. 0 max. 1 Trigger power supply watchdog, output voltage 0 Volt
6.2	Limits: min. 54 max. 82 Trigger power supply watchdog, low output voltage
6.3	Limits: min. 0 max. 1 power supply watchdog defective Do not trigger power supply watchdog, same voltage selection as 6.2, measured:0V
7.	Test of selected output voltages of high power supply
7.1	Limits: min. 0 max. 1 Trigger power supply watchdog, 0 Volt
7.2	Limits: min. 0 max. 4 Bit 0, power supply voltage outside of limits
7.3	Limits: min. 3 max. 7 Bit 1, power supply voltage outside of limits; power supply defective

¹ not valid for A-3000/ -2000
² not valid for Arco-2000

³ not valid for MBC600
⁴ not valid for Arco-1000

7.4	Limits: min. 9 max. 13 Bit 2, power supply voltage outside of limits; power supply defective
7.5	Limits: min. 20 max. 24 Bit 3, power supply voltage outside of limits; power supply defective
7.6	Limits: min. 43 max. 49 Bit 4, power supply voltage outside of limits; power supply defective
7.7	Limits: min. 86 max. 99 Bit 5, power supply voltage outside of limits; power supply defective
7.8	Limits: min. 170 max. 195 Trigger power supply watchdog, maximum value 100V; power supply defective
7.9	Limits: min. 0 max. 1 Trigger power supply watchdog, back to 0V
8.	Test of handpiece recognition function
8.1	Limit: 10 Test channel 1: result must be 0; HSE defective
8.2	Limit: 10 Test channel 2: result must be 10; HSE defective
9.	Resonance frequency serial resonant circuit RF-out, test of PE-channel
9.1	Limits: min. 80 max. 200 Search for frequency minimum, gives information about patient safety capacitor
9.2	Limits: min. 0 max. 32 Test PE-recognition; PE-recognition defective
9.3	Limits: min. 176 max. 255 Test PE-recognition; PE-recognition defective
9.4	Limits: min. 176 max. 255 Test PE-recognition; PE-recognition defective
10.	Test of output relays
10.1	min 1. 0 / min 2. 176 max 1. 48 / max 2. 255 Relay test #3: switching changes; Relay #3 defective
10.2	min 1. 176 / min 2. 0 max 1. 255 / max 2. 48 Relay test #5: switching changes; Relay #5 defective
10.3	min 1. 176 / min 2. 0 max 1. 255 / max 2. 48 Relay test #6: switching changes; Relay #6 defective
10.4	min 1. 176 / min 2. 0 max 1. 255 / max 2. 48 Relay test #7: switching changes; Relay #7 defective
10.5	min 1. 176 / min 2. 0 max 1. 255 / max 2. 48 Relay test #8: switching changes; Relay #8 defective
10.6	min 1. 0 / min 2. 145 max 1. 10 / max 2. 172 Relay test #4: switching changes; Relay #4 defective
11.	Determination of offset values in measurement channels with high precision Repetition of offset determination
11.1	Limits: min. 0 max. 5 Measuring channel I80 defective determine offset of I80
11.2	Limits: min. 0 max. 5 Measuring channel U80 defective determine offset of U80 (Output voltage high power supply)
11.3	Limits: min. 1 max. 16 Measuring channel PWR defective determine offset of PWR (RF-output voltage CPU-ADC)
11.4	Limits: min. 1 max. 83 Measuring channel PWR_L defective determine offset of PWR_L (RF-output power Low I ² C-ADC)
11.5	Limits: min. 6 max. 57 Measuring channel PWR_H defective determine offset of PWR_H (RF-output power High I ² C-ADC)
11.6	Limits: min. 0 max. 9 Measuring channel HF_VOLT defective determine offset of HF_VOLT (RF-output voltage)

¹ not valid for A-3000/ -2000
² not valid for Arco-2000

³ not valid for MBC600
⁴ not valid for Arco-1000

12.	Check of cut module output power at a test resistor
12.1	Limits: min. 6 max. 14 Power selection 1; Cut module defective
12.2	Limits: min. 60 max. 80 Power selection 2; Cut module defective
12.3	Limits: min. 110 max. 150 Power selection 3; Cut module defective
12.4	Limits: min. 160 max. 220 Power selection 4; Cut module defective
12.5	Limits: min. 220 max. 280 Power selection 5; Cut module defective
12.6	Limits: min. 20 max. 47 Test current limiting; Cut module defective
12.7	Limits: min. 120 max. 190 Test current limiting; Cut module defective
13.	Check of coag module output power at a test resistor
13.1	Limits: min. 15 max. 25 Power selection 1; Coag module defective
13.2	Limits: min. 35 max. 55 Power selection 2; Coag module defective
13.3	Limits: min. 60 max. 80 Power selection 3; Coag module defective
13.4	Limits: min. 80 max. 110 Power selection 4; Coag module defective
13.5	Limits: min. 100 max. 140 Power selection 5; Coag module defective

Power-supply data

Mains connection: 230v \pm 10%, 50 Hz \pm 5%
internally switchable to
115v \pm 10%, 60 Hz \pm 5%

Mains fuses: built into mains-filter containing 2 fuses T 4A/250V
according to DIN 41 662 for 230V mains-voltage
respectively T 8A/250V for 115v mains-voltage

Mains cable: length 2.5 m with protective conductor, mains-part according
to DIN 49 441 resp. CEE 7 p.VII, equipment-part according
to DIN 49 457 p.1., Plug and socket vulcanized to cable.
The cable must comply with actual standards and must have
a cross sectional area of 1 mm²

Potential equalization: Connector according to DIN

Power consumption: 1000 VA

¹ not valid for A-3000/ -2000
² not valid for Arco-2000

³ not valid for MBC600
⁴ not valid for Arco-1000

Power diagram Cutting⁴

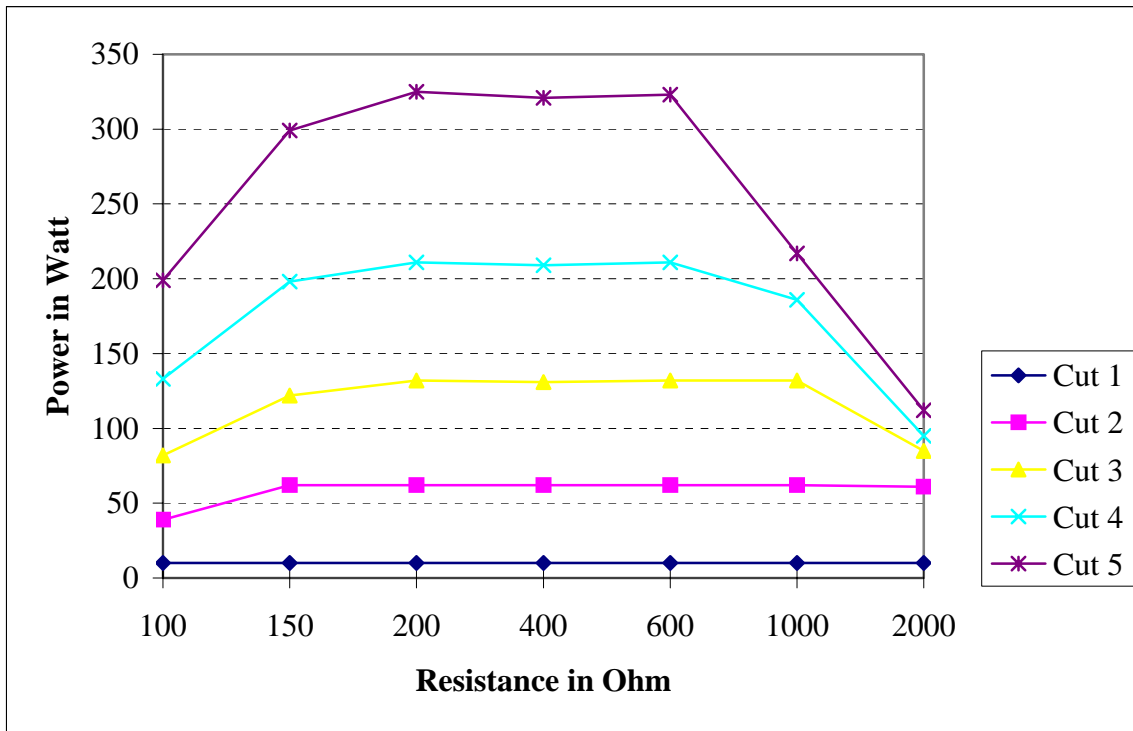

Power diagram Blend⁴

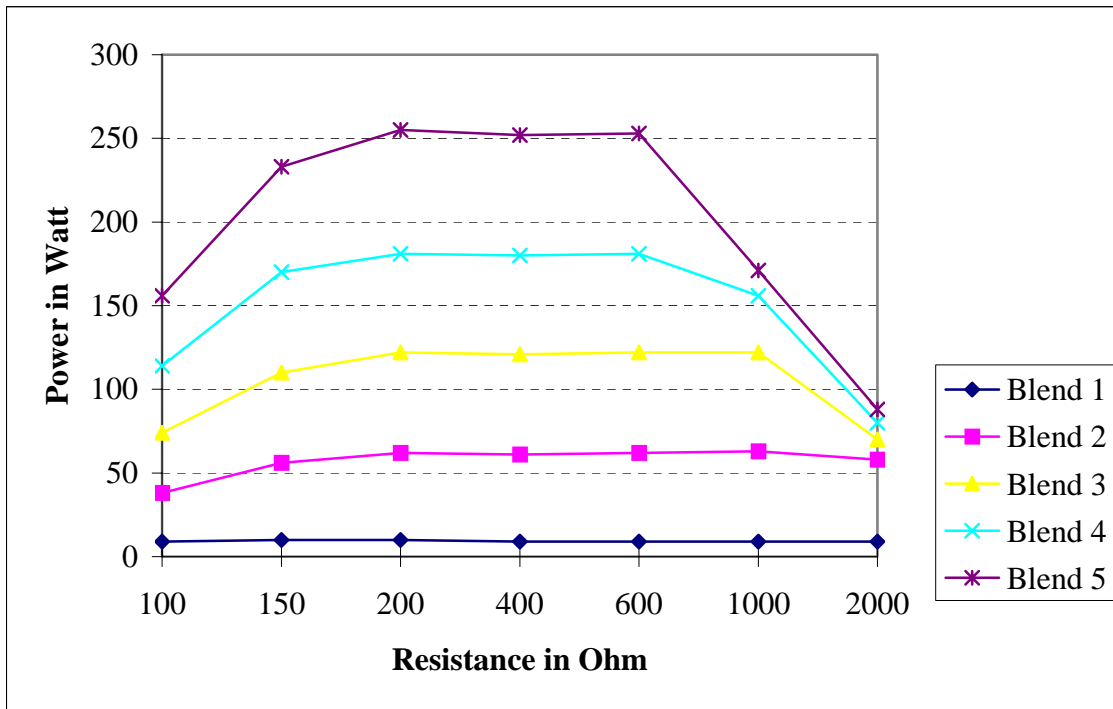

¹ not valid for A-3000/ -2000
² not valid for Arco-2000

³ not valid for MBC600
⁴ not valid for Arco-1000

Power diagram TUR⁴

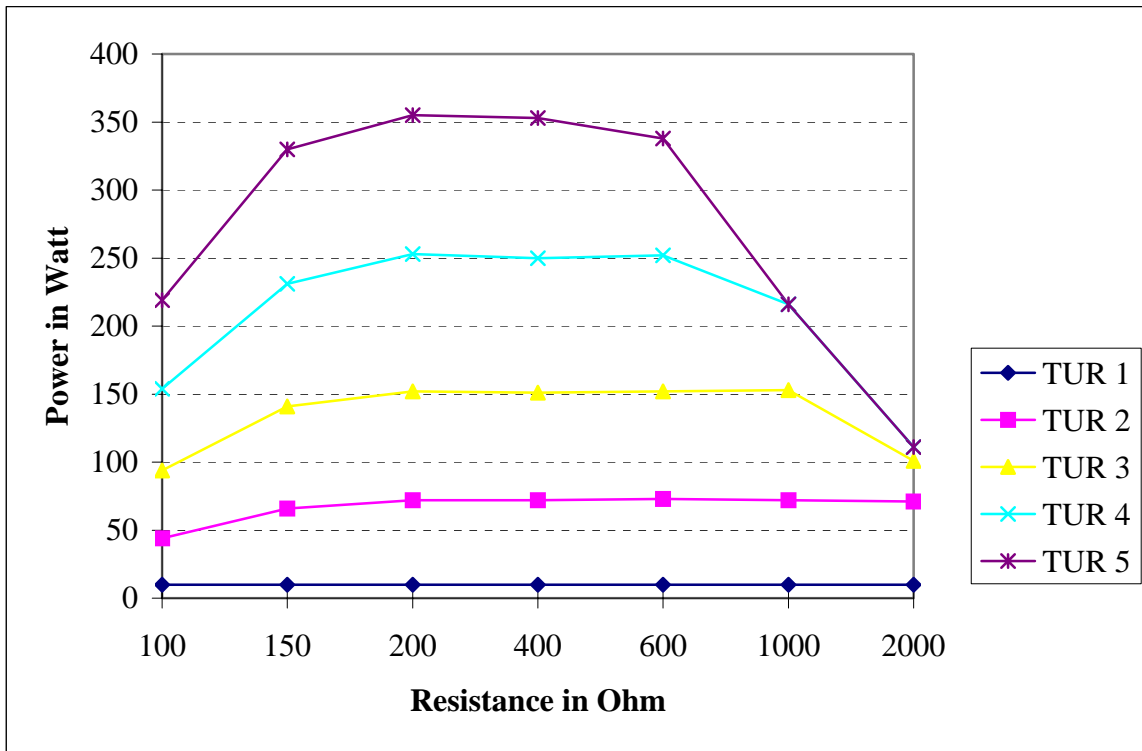

Power diagram Pulse⁴

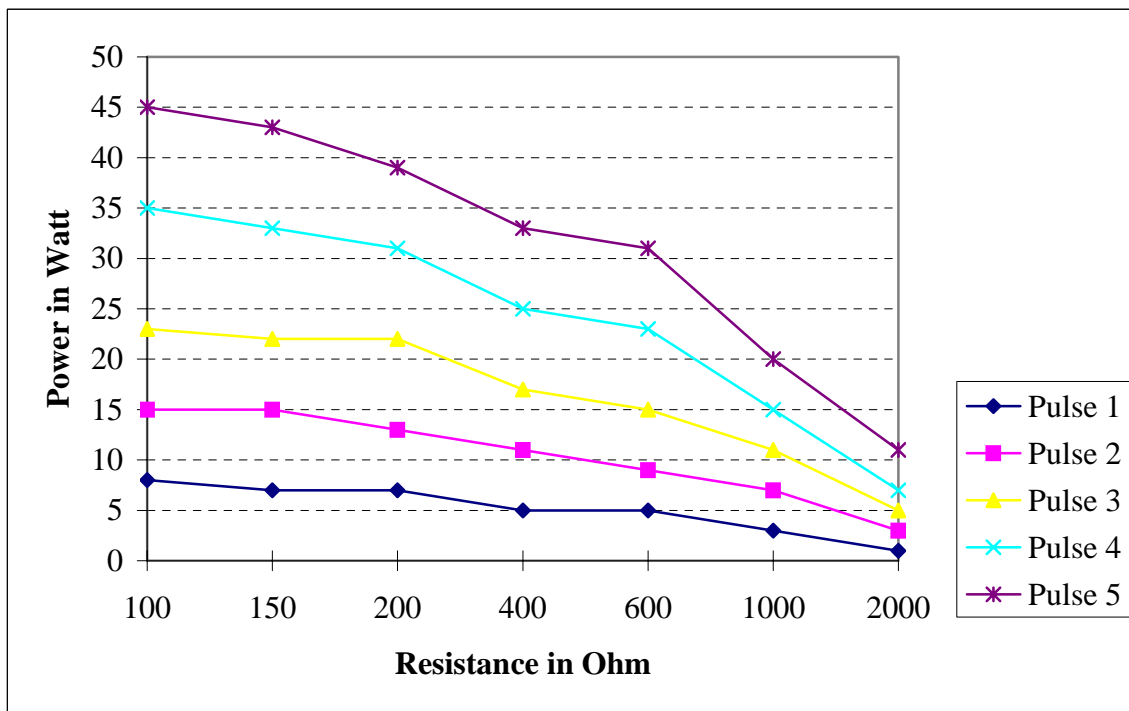

¹ not valid for A-3000/ -2000
² not valid for Arco-2000

³ not valid for MBC600
⁴ not valid for Arco-1000

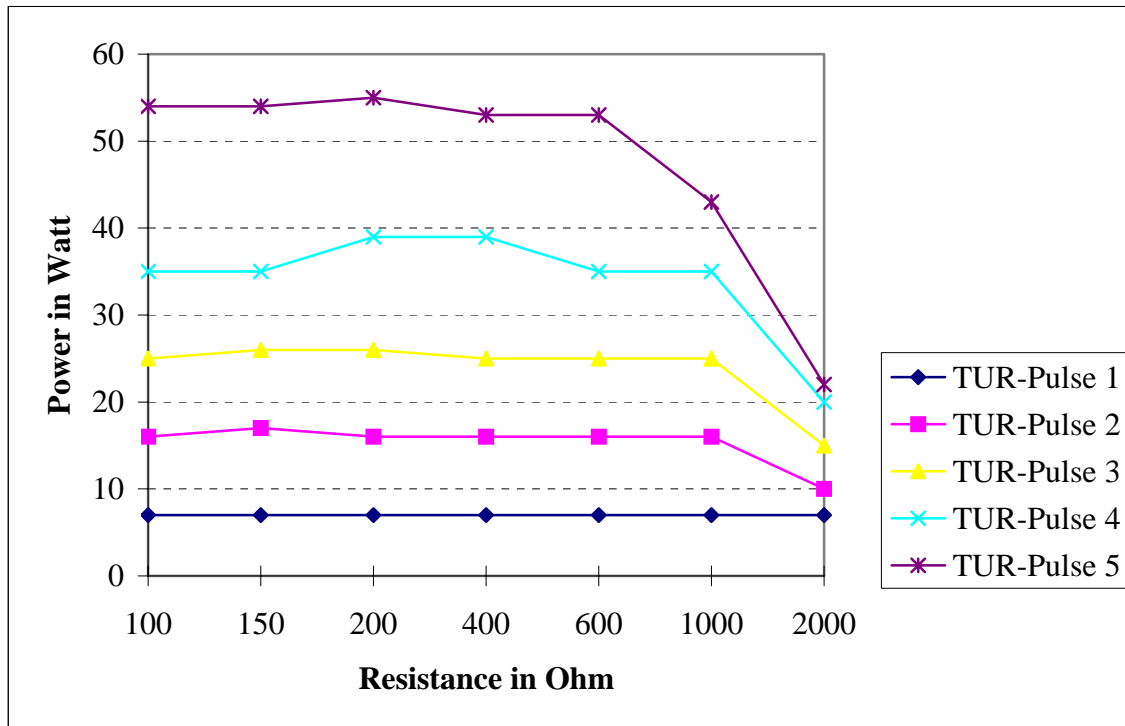
Power diagram TUR-Pulse⁴

¹ not valid for A-3000/ -2000
² not valid for Arco-2000

³ not valid for MBC600
⁴ not valid for Arco-1000

Power diagram Spray-Coagulation

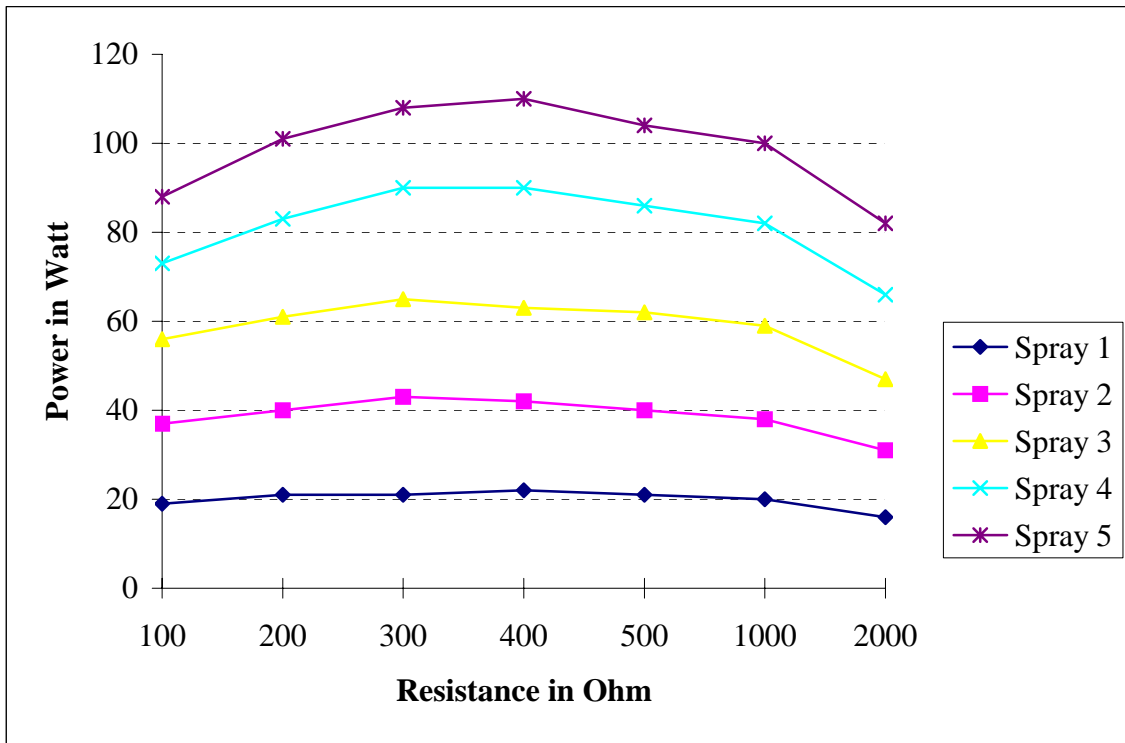

Power diagram Force-Coagulation -Effect 1⁴

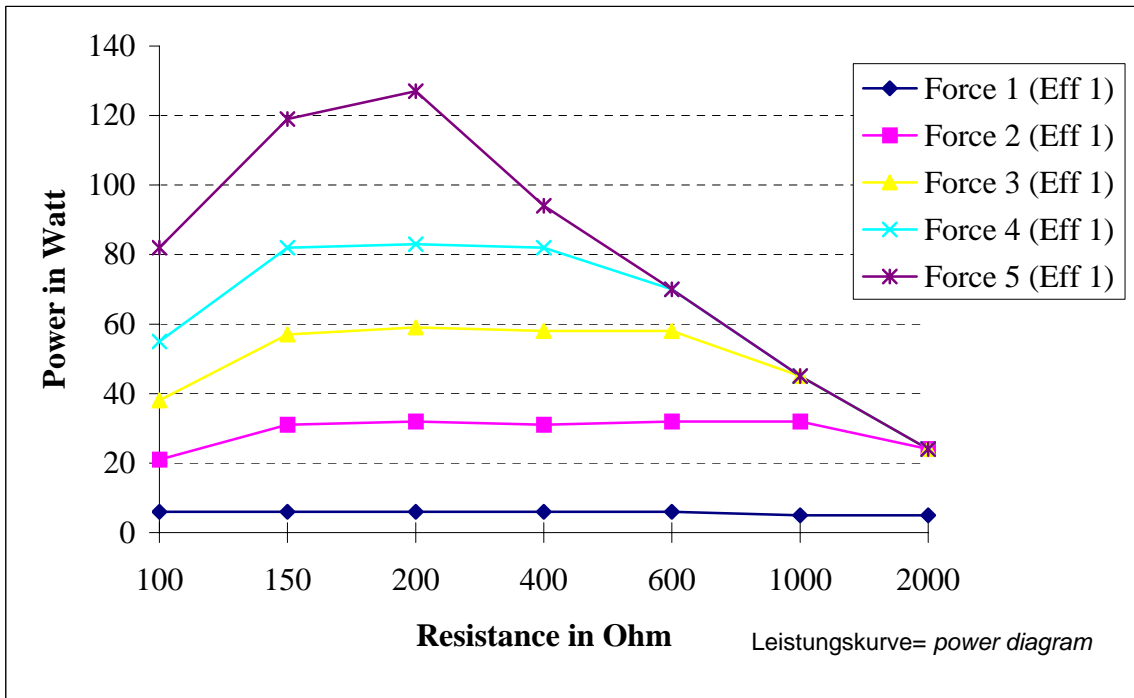

¹ not valid for A-3000/ -2000
² not valid for Arco-2000

³ not valid for MBC600
⁴ not valid for Arco-1000

Power diagram Force-Coagulation -Effect Hi⁴

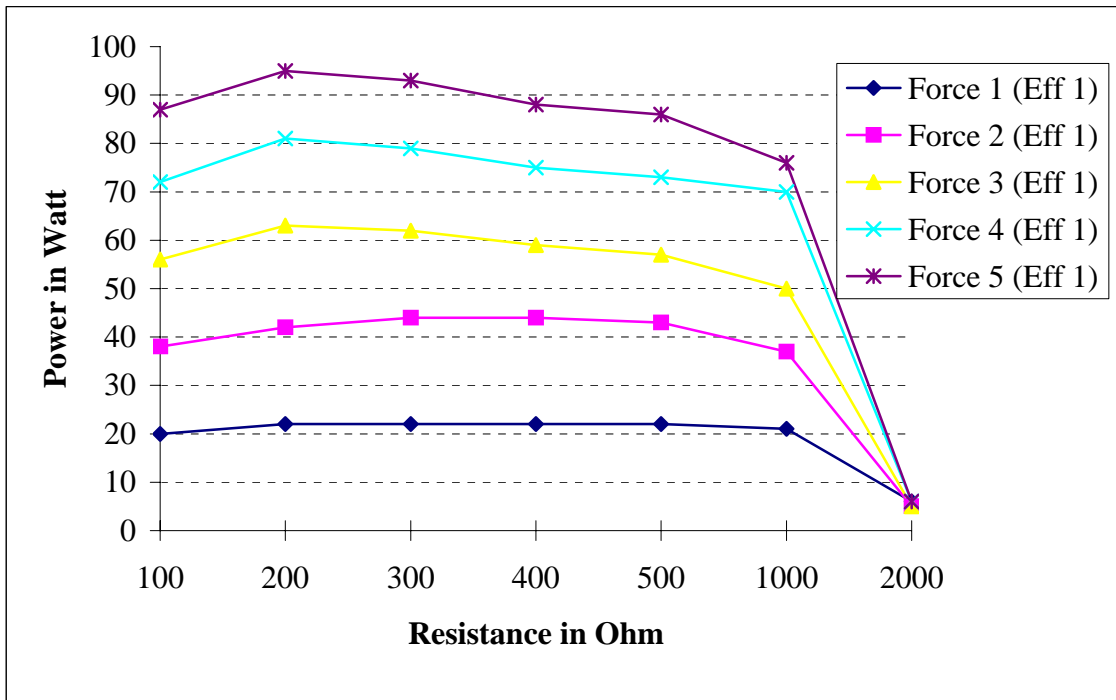

Power diagram Force-Coagulation -Effect 5⁴

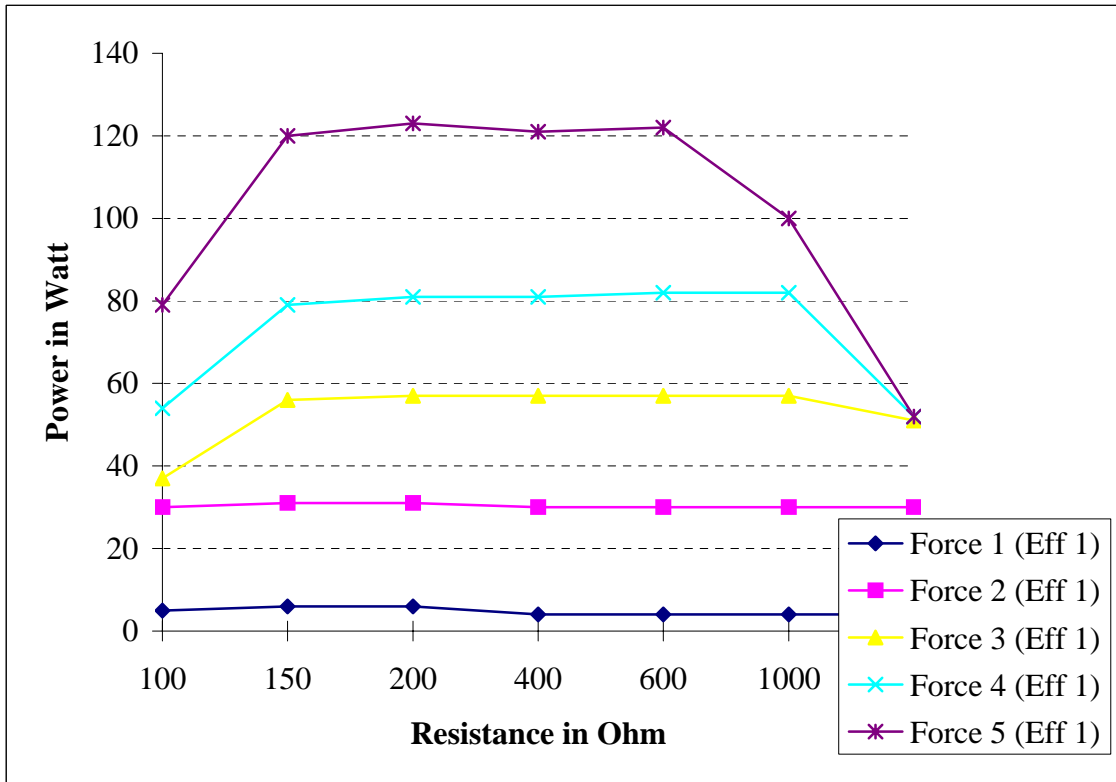

¹ not valid for A-3000/ -2000
² not valid for Arco-2000

³ not valid for MBC600
⁴ not valid for Arco-1000

Power diagram Force-Coagulation -Effect 9⁴

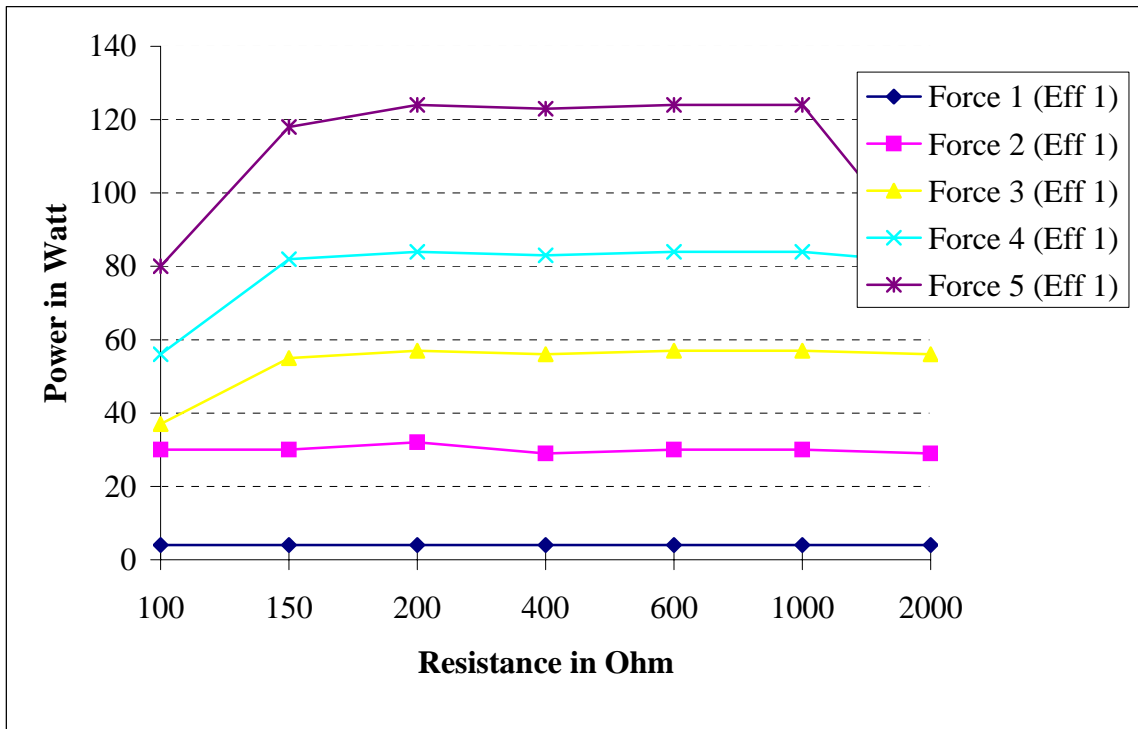

Power diagram Soft-Coagulation⁴

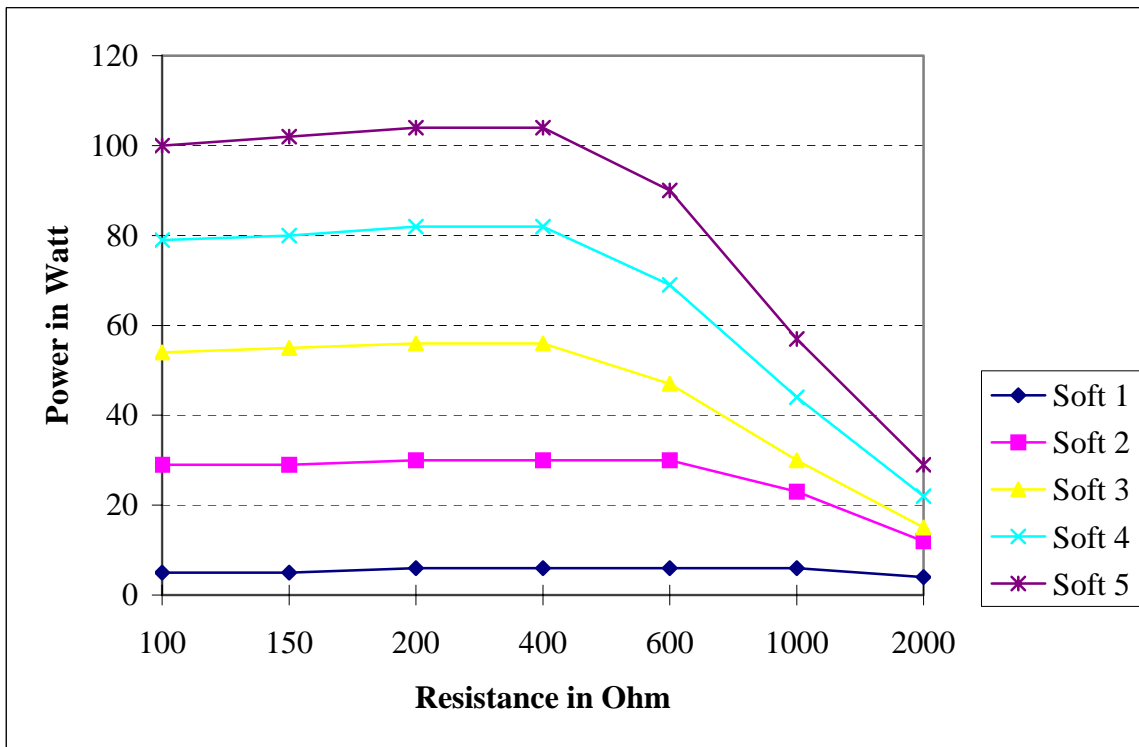

¹ not valid for A-3000/ -2000
² not valid for Arco-2000

³ not valid for MBC600
⁴ not valid for Arco-1000

Power diagram Argon 1,6-Coagulation⁴

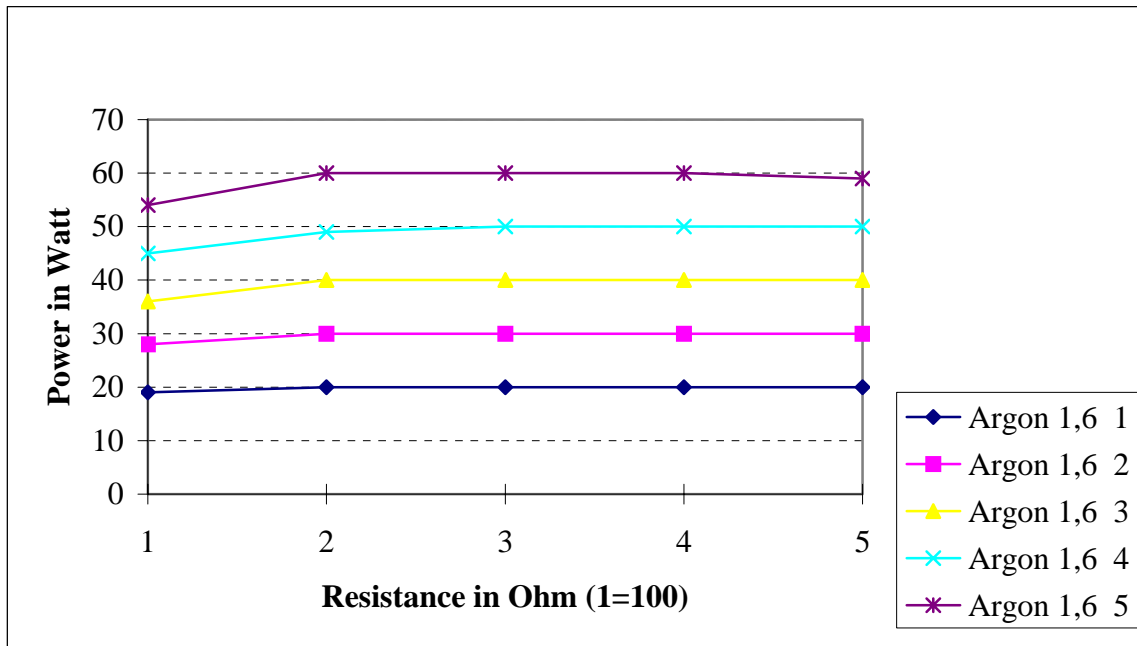

Power diagram Argon 2,4-Coagulation⁴

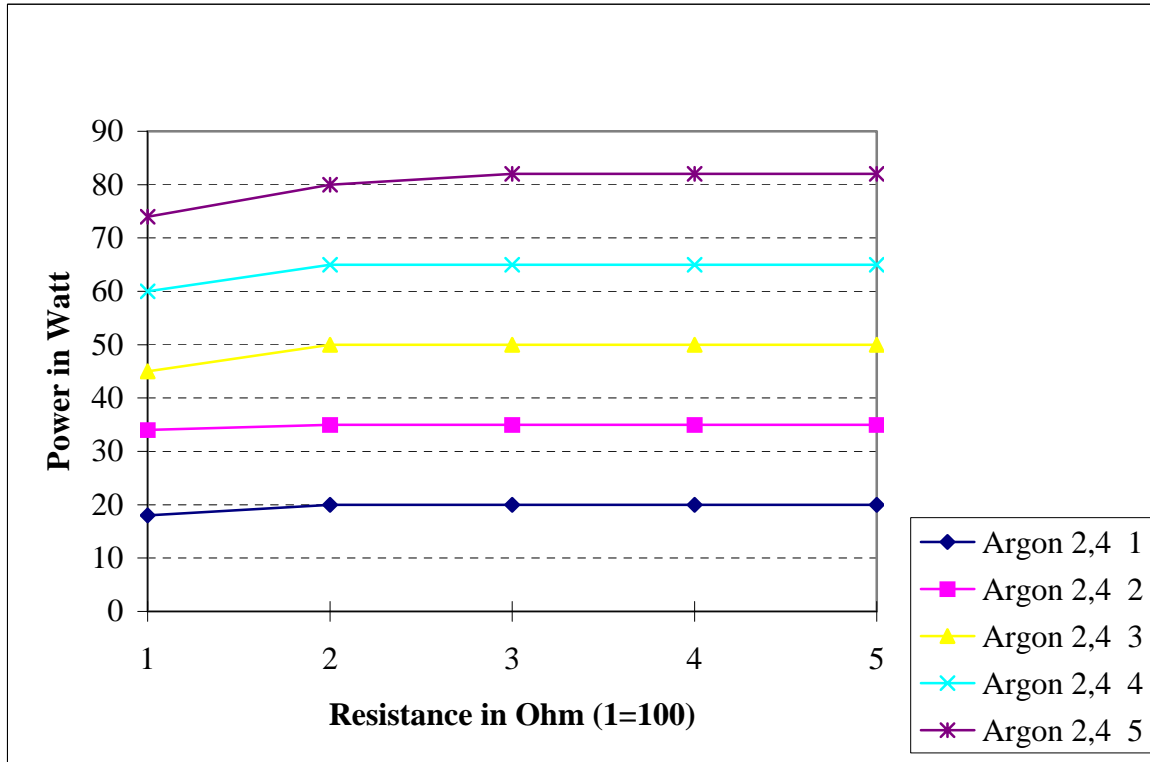

¹ not valid for A-3000/ -2000
² not valid for Arco-2000

³ not valid for MBC600
⁴ not valid for Arco-1000

Power diagram Argon open-Coagulation⁴

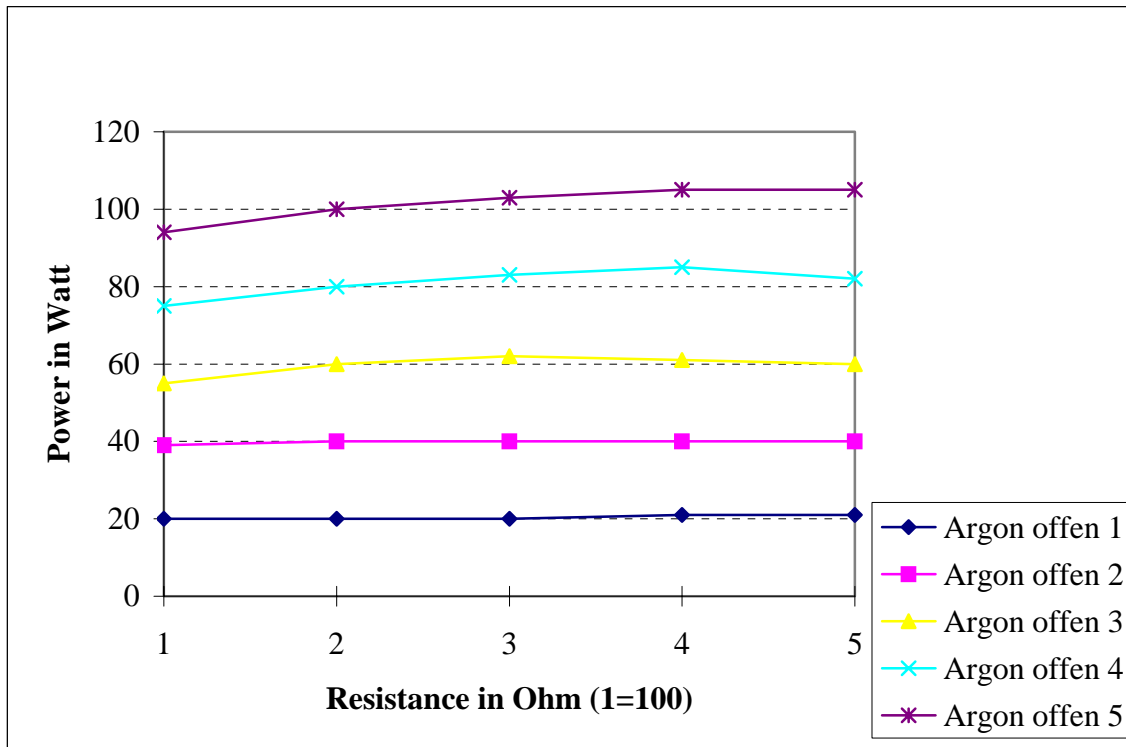

¹ not valid for A-3000/ -2000
² not valid for Arco-2000

³ not valid for MBC600
⁴ not valid for Arco-1000

Power diagram Bipolar Cutting^{2,3,4}

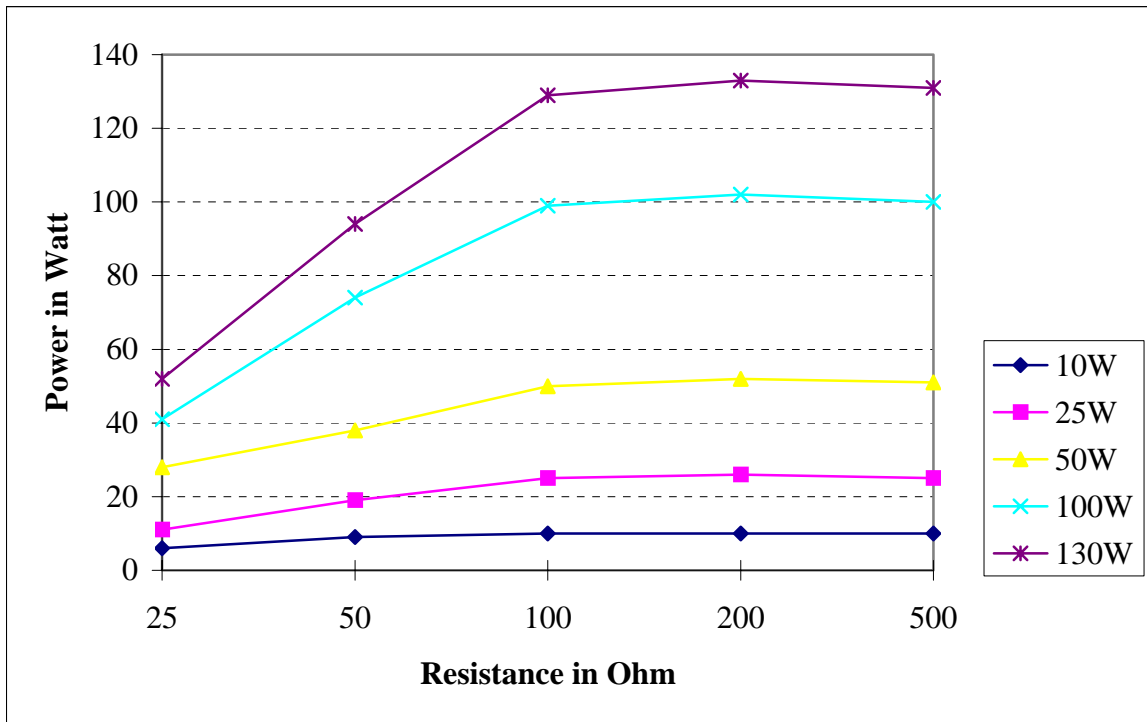

Power diagram Bipolar Coagulation^{2,4}

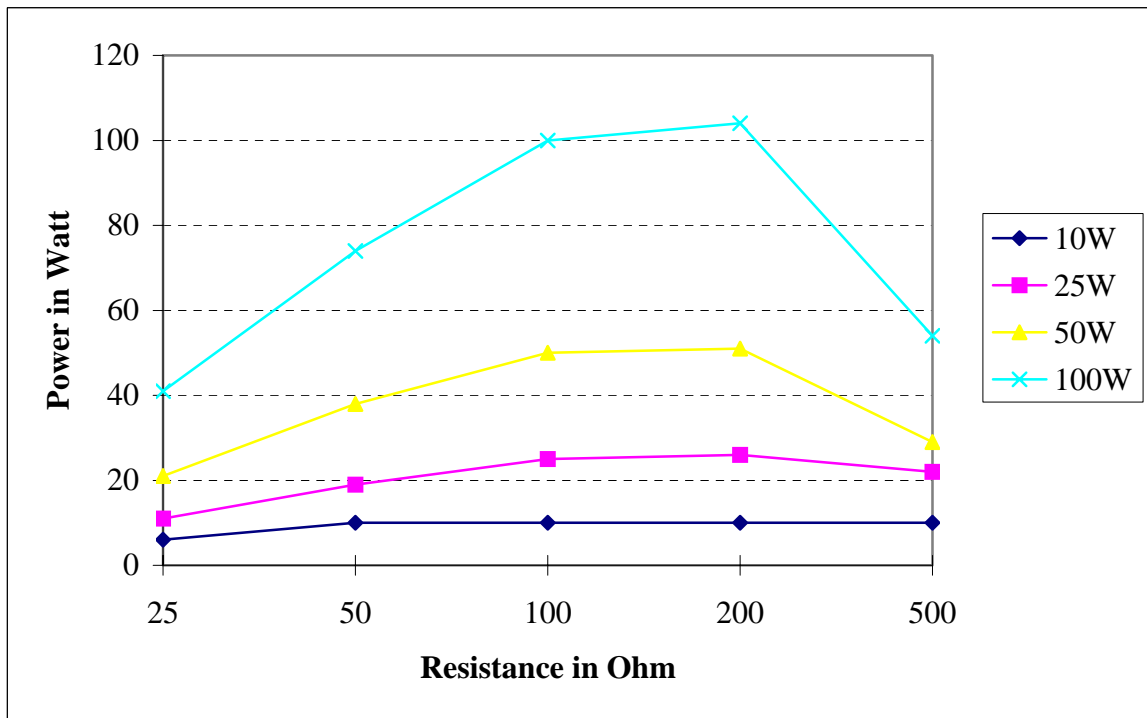

¹ not valid for A-3000/ -2000
² not valid for Arco-2000

³ not valid for MBC600
⁴ not valid for Arco-1000

13.1. Visual and acoustical signals

Activation	RF on	Visual signal	Acoustical signal
Power on		Green switch light	
Cutting ⁴	X	Yellow working-indicator	Continuous tone 440 Hz
Coagulation ⁴	X	Yellow working-indicator	Continuous tone 480 Hz
Argon ¹	X	Yellow working-indicator	Continuous tone 500 Hz
Bipolar Cutting ^{2,3,4}	X	Yellow working-indicator	Continuous tone 550 Hz
Bipolar Coagulation ^{2,4}	X	Yellow working-indicator	Continuous tone 550 Hz
PE- failure		Red blinking signal	Modulated warning-tone 370 Hz
Function error	X	Red signal	
Output power error	X	Red signal	

The level of the acoustical signal is adjustable between 45 and 65 dB(A).

The level of the warning-tone (Patient electrode failure) is fixed at 65 dB(A).

Classification

Safety class: I

Safety grade: according to EN60601-1 CF

Weight without trolley (Arco/RF): 24kg / 19kg

Dimensions (Arco/RF): WxHxD 430mm x 150mm x 560mm / 430 x 150 x 430

Applicable standards: EN60601-1, EN60601-2-2, VDE0750, VDE0107

¹ not valid for A-3000/ -2000
² not valid for Arco-2000

³ not valid for MBC600
⁴ not valid for Arco-1000

14. Technical checks regarding safety (TSC)

The safety concept comprises

- patient protection
 - Patient electrode contact recognition
 - Check of pre-selected parameters (output power error)
 - Automatic self test on start of equipment
 - Technical checks regarding safety

Furthermore the Cut-module and the Coag-module are short-term short-circuit proof. The high-power supply is equipped with an over-current disconnection and is permanently short-circuit proof. A check of power supply (correct voltage), of the switch-on stage within the Cut- and Coag-module (no current drain with applied supply voltage) as well as a test of indicators is performed at every switch-on of the equipment. A watch-dog prevents uncontrolled conditions in case the software fails.

14.1. Intervals

Safety-technical checks have to be carried out annually.

14.2. Extent

Check for presence of equipment book and instruction-manual.

- Check for electrical safety according to DIN VDE 0751m- part 1: 1989
 - Check of protective conductor ($<0.3\Omega$)
 - Check of equipment leakage current (case) ($< 0.5\text{ ma}$)
 - Patient leakage current monopolar application part ($<10\mu\text{A}$)
 - Patient leakage current bipolar application part ($< 10\mu\text{A}$)
 - Check of controls and indicators
 - Check of RF-generators (delivery of power)
 - Check of RF-leakage current (handpieces, PE-electrode)
 - Check of patient electrode monitoring
 - Check of power monitoring
 - Check of handpieces and foot switches for proper condition

14.3. Description of special checks

14.3.1 Check of controls and indicators

- Connect handpieces and patient electrode according to instruction manual
- Switch-on equipment and check indicator-lights
- Select a power-step for cutting⁴ and coagulation⁴ and activate handpiece switch (blue or yellow button respectively footswitch)
Acoustical signal for cutting and coagulation must be present
Handpiece-mode recognition must light up
- Connect bipolar connecting cable^{2,4} and bipolar tool according to instruction manual. Bipolar-mode recognition must light up. If necessary press a key within the bipolar field and activate foot switch
 - Acoustical signal for bipolar function must be present
 - Bipolar-mode recognition must light up

¹ not valid for A-3000/ -2000
² not valid for Arco-2000

³ not valid for MBC600
⁴ not valid for Arco-1000

14.3.2 Check of handpieces and foot switches

- Perfect condition of plug and cable
- Mechanical faults, especially cracks in handpiece housing
- Function test of all handpieces and foot switches

14.3.3 Check of RF-generators and safety-devices

Function-test of RF-generators, RF-relays and leakage current detector.

The following equipment is needed:

- Measuring device for RF-surgery equipment for measurement of output power and RF-leakage current, e.g. BIO-TEK RF-302
- Handpieces
- Connecting cable patient electrode
- Cables and clamps

Preparation

Connect RF-measuring device to the RF-unit in accordance with instruction manual. Connect active electrode via handpiece. Establish connections to patient electrode, equipment-frame and earth according to specifications of measuring- device manufacturer. Checks of leakage current must be performed according to safety class "CF".

14.3.4. Power measurement

Values for power output see table in chapter 8. Observe load resistors.

Generally the function is correct if the RF-power does not deviate more than $\pm 20\%$ from the nominal value.

14.3.5 Check of power monitoring

The equipment switches off if due to faults the delivered power exceeds the selected value by more than 25%. For this purpose a measuring device is built in which checks the actual output power. In service mode 14 this power is indicated and can be compared with the measured power (RF-meter) by the following procedure:

- Switch equipment to service mode 14
- Measure power for Cut step 2-5 and Spray/Argon step 2-5 (load 200 ϕ) and compare it to indication. The maximum difference is $\phi 10\%$.
- Leave service mode after finishing test

14.3.6 Measurement of leakage current

Set RF-power meter to position active electrode and PE-leakage current check. Leakage current measurement is done in "CF"-mode. Within the load range 100 Ohm to 500 Ohm the leakage current for all operational modes must be less than 150 mA.

¹ not valid for A-3000/ -2000
² not valid for Arco-2000

³ not valid for MBC600
⁴ not valid for Arco-1000

14.3.7. Measurement of gas-flow¹

For these measurements a gas-flow meter is required (e.g. gas-flow meter from Brooks) or an electronic gas flow meter calibrated for Argon at normal pressure.

- Connect gas-nozzle of gas handpieces and probes to the flow-meter.
- Select Argon-step 1 - 5 (for values see table "Technical gas data") and check gas-flow for each step.

Generally the gas-flow is correct if it does not deviate more than $\pm 25\%$ from the nominal value.

14.3.8 Test of gas flow check

For gas delivery the equipment checks whether a handpiece delivers gas. For this purpose the flow is measured and regulated. Furthermore a check of gas pressure at the input of the equipment is done. If the pressure at the input is too low (empty gas bottle, pressure below 4.5 bar) the gas shortage indication lights up and a warning signal sounds. If gas flow is impossible due to a clogged handpiece hose a warning is also given. In both cases the argon coagulation is inhibited. Checking is done with a connected Argon handpiece.

- Select Argon step 3 and start equipment. Close gas valve at the gas bottle. After pressure drops, alarm sounds, gas shortage is indicated and equipment switches off.
- Open gas valve again and start equipment, then kink the hose of the Argon handpiece (interrupt gas flow). Equipment must switch off, alarm tone and indication "gasflow interrupted" must appear.

14.3.9. Check of handpiece allocation-relay

In case the equipment has several handpiece sockets both monopolar handpieces are connected. With activation of one of the handpieces it has to be checked whether the non activated handpiece delivers power. In case power is delivered, one of the handpiece allocation-relays is defective.

¹ not valid for A-3000/ -2000
² not valid for Arco-2000

³ not valid for MBC600
⁴ not valid for Arco-1000

Annex

Layout and circuit plans of existing boards and modules can be obtained by trained personnel on request only!

¹ not valid for A-3000/ -2000
² not valid for Arco-2000

³ not valid for MBC600
⁴ not valid for Arco-1000

