

OWNER'S MANUAL

POWER VACUUMS

Model Numbers

- 243-675A
- 243-685A
- 243-689A
- 24677U
- 24687U

Important:
Read Safety Rules and
Instructions Carefully

Thank you for purchasing an
American built product.

INDEX

Safe Operation Practices	3	Maintenance	10
Assembly Instructions	4	Off-Season Storage	1
Operation	9	Illustrated Parts	12, 14
Adjustments	9	Replacement Parts List	13, 15
Lubrication	10	Parts Information.....	Back Cover

LIMITED WARRANTY

For one year from the date of original retail purchase, MTD PRODUCTS INC will either repair or replace, at its option, free of charge, F.O.B. factory or authorized service firm, any part or parts found to be defective in material or workmanship. Transportation charges for the movement of any power equipment unit or attachment are the responsibility of the purchaser. Transportation charges for any parts submitted for replacement under this warranty must be paid by the purchaser unless such return is requested by MTD PRODUCTS INC.

This warranty will not apply to any part which has become inoperative due to misuse, excessive use, accident, neglect, improper maintenance, alterations, or unless the unit has been operated and maintained in accordance with the instructions furnished. This warranty does not apply to the engine, motor, battery, battery charger or component parts thereof. Please refer to the applicable manufacturer's warranty on these items.

This warranty will not apply where the unit has been used commercially.

Warranty service is available through your local authorized service dealer or distributor. If you do not know the dealer or distributor in your area, please write to the Customer Service Department of MTD.

The return of a complete unit will not be accepted by the factory unless prior written permission has been extended by MTD.

This warranty gives you specific legal rights. You may also have other rights which vary from state to state.



WARNING

TO PURCHASERS OF INTERNAL COMBUSTION ENGINE EQUIPPED MACHINERY OR DEVICES IN THE STATE OF CALIFORNIA

The equipment which you have just purchased does not have a spark arrester. If this equipment is used on any forest covered land, brush covered land, or grass covered unimproved land in the State of California, before using on such land, the California law requires that a spark arrester be provided. In addition, spark arrester is required by law to be in effective working order. The spark arrester must be attached to the exhaust system and comply with Section 4442 of the California Public Resources Code.

IMPORTANT

It is suggested that this manual be read in its entirety before attempting to assemble or operate. Keep this manual in a safe place for future reference and for ordering replacement parts.

This unit is shipped WITHOUT GASOLINE or OIL. After assembly, see operating section of this manual for proper fuel and amount.

SAFE OPERATION PRACTICES FOR POWER VACUUMS

- . Read this operating and service instructing manual carefully. Be thoroughly familiar with the controls and proper use of the power vacuum.
- . Never allow children to operate this power vacuum.
- . Keep the area of operation clear of all persons, particularly small children and pets.
- . Check fuel before starting engine. Do not fill fuel tank indoors, when engine is running, or while engine is hot. Wipe off any spilled fuel before starting engine.
- . Do not change engine governor settings.
- . Do not put hands near rotating parts for any reason.
- . If the power vacuum should start to vibrate abnormally, stop the engine and check immediately for the cause. Vibration is generally a warning of trouble.
- . Before cleaning, repairing or inspecting, make certain all moving parts have come to a complete stop. Disconnect spark plug wire and keep wire away from plug to prevent accidental starting. Also keep throttle control lever in the stop position.
- l. If the power vacuum should become blocked with debris at any point, shut engine off and wait until the impeller comes to a complete stop before attempting to remove the obstruction. Disconnect spark plug wire to prevent accidental starting.
- 10. Check all bolts for tightness at frequent periods.
- 11. Never store this power vacuum with fuel in the tank. Allow engine to cool before storing in any enclosure.
- 12. Keep bag and equipment free of debris when not in use.
- 13. Never operate this power vacuum unless air duct and vacuum bag are properly affixed in their place. Large zippered end of bag must be closed when operating to prevent objects from being blown out.
- 14. Never empty vacuum bag when engine is running.
- 15. Never change inlet nozzle or auxiliary hose attachment when engine is running.
- 16. The manufacturer recommends that the operator wear safety glasses or some other suitable eye protection when operating this machine.
- 17. Check the vacuum bag frequently for wear and replace when necessary.
- 18. Never operate as a leaf blower unless impeller guard and guard assembly are properly affixed in their place.
- 19. Exercise caution whenever operating as a leaf blower. Do Not allow discharge to be pointed in the direction of persons.

ASSEMBLY INSTRUCTIONS

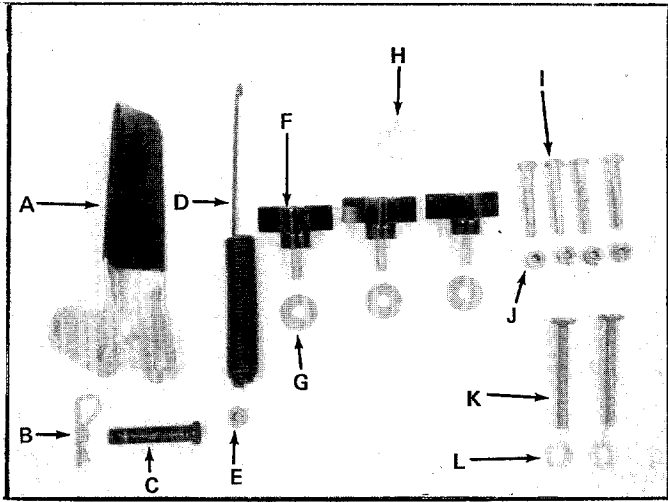

FIGURE 1.

CONTENTS OF HARDWARE PACK (See Figure 1.)

- A (1) Clutch Grip Assembly*
- B (1) Hair Pin Cotter*
- C (1) Clevis Pin*
- D (1) Extension Spring*
- E (1) Lock Nut 1/4-20 Thread*
- F (3) Hand Knobs
- G (3) Belleville Washers
- H (1) Heavy Flat Washer
- I (4) Hex Bolts 1/4-20 x 1.75" Long
- J (4) Hex Lock Nuts 1/4-20 Thread
- K (2) Stud Pins
- L (2) Push-on Speed Nuts
- (1) Hex Jam Nut 1/4-20 Thread* (Not Shown)

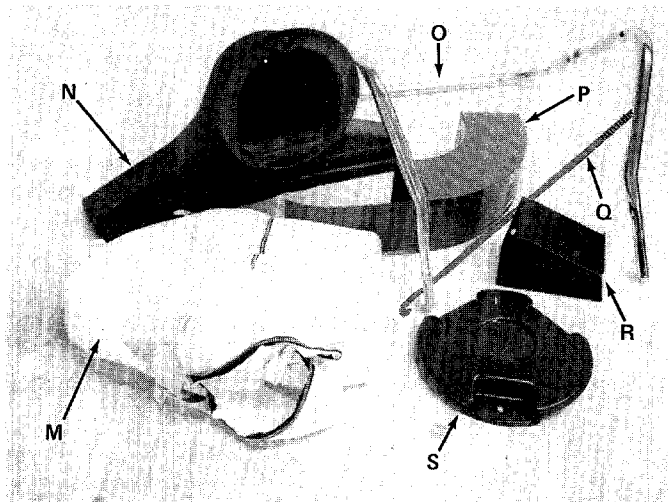

FIGURE 2.

LOOSE PARTS IN CARTON (See Figure 2.)

- M (1) Bag
- N (1) Nozzle
- O (1) Upper Handle
- P (1) Air Duct Assembly
- Q (1) Clutch Rod*
- R (1) Directional Discharge Assembly
- S (1) Impeller Guard

*Self-Propelled Models Only.

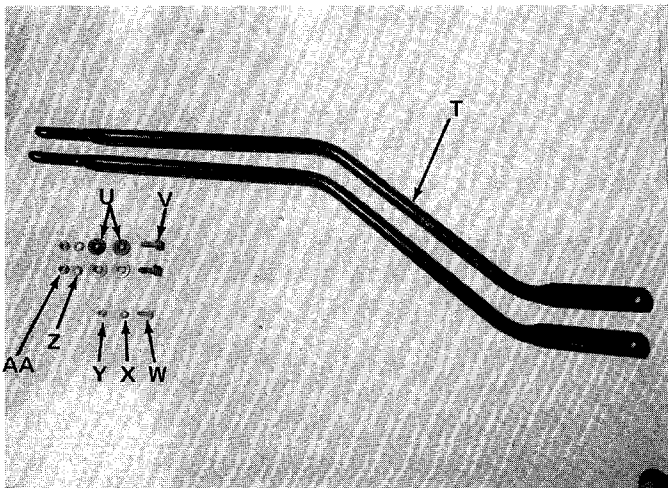
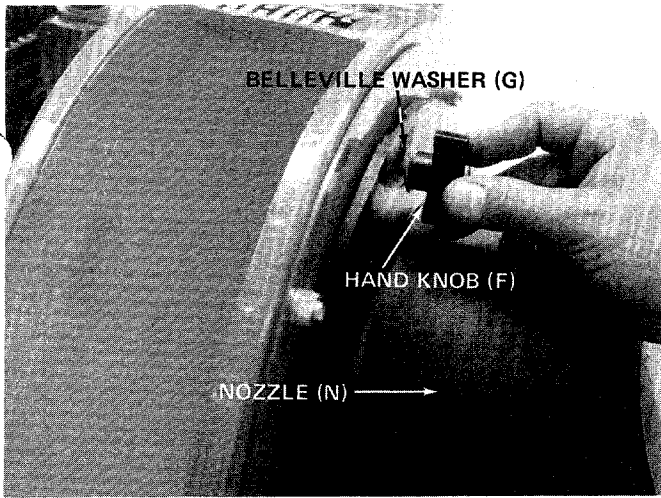

FIGURE 3.

TOW BAR KIT - Standard with push models. Optional (See figure 3.) with self-propelled models.

- T (2) Tow Bar Halves
- U (4) Shoulder Spacers
- V (2) Hex Bolts 5/16-18 x 1.00" Long
- W (1) Truss Machine Screw 1/4-20 x .75" Long
- X (1) Lock Washer 1/4" I.D.
- Y (1) Hex Nut 1/4-20 Thread
- Z (2) Lock Washers 5/16" I.D.
- AA (2) Hex Nut 5/16-18 Thread



1. Place nozzle (N) in position on front of housing so that it rests in flanges. Secure with one hand knob (F) and belleville washer (G). See figure 4.

FIGURE 4.

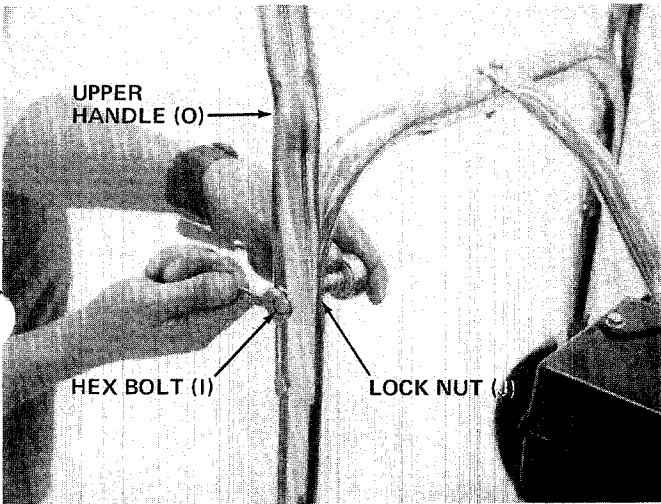

2. Place the upper handle (O) in position over lower handle. Fasten with four hex bolts (I) and lock nuts (J) provided. See figure 5. Two 7/16" wrenches are required.

FIGURE 5.

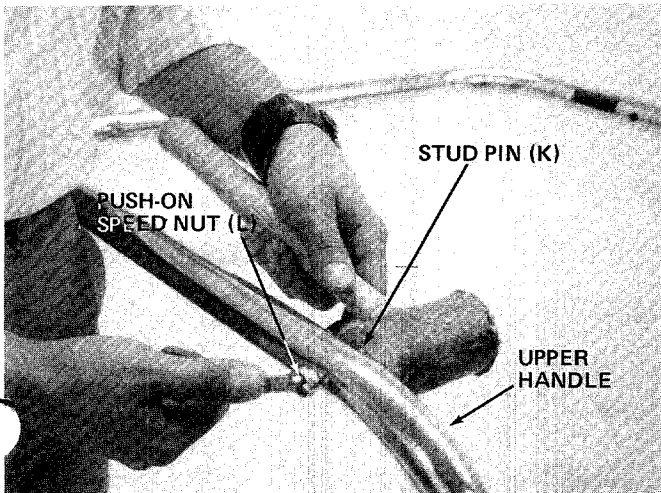

3. Place the stud pins (K) in holes in upper handle (head of pins go to the inside of handle). Secure pins with push-on speed nuts (L) by holding speed nut with box wrench and tapping pin with hammer. See figure 6.

FIGURE 6.

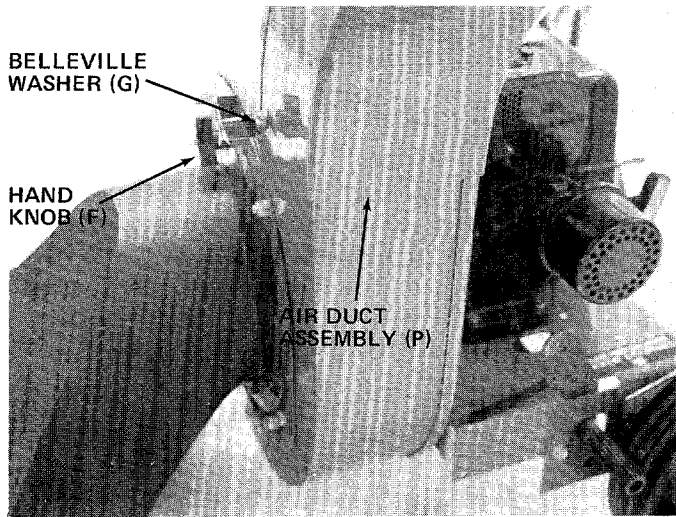

4. Place air duct assembly (P) over opening on top of housing. Secure with two hand knobs (F) and Belleville washer (G). See figure 7.

FIGURE 7.

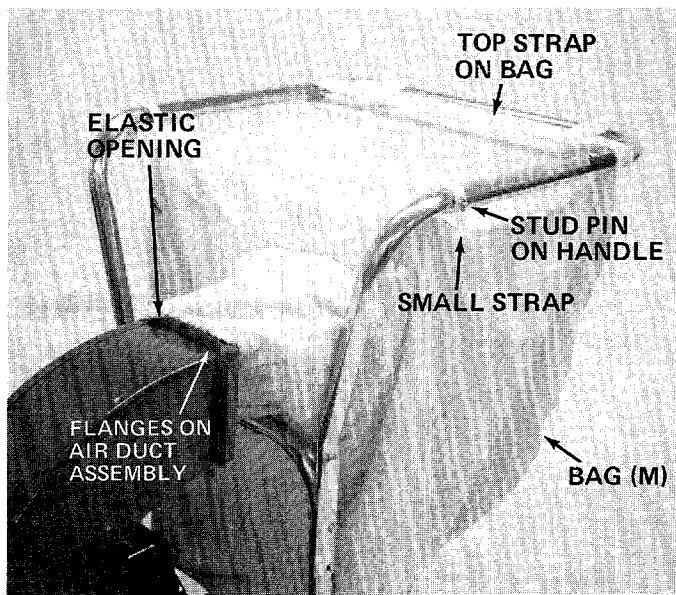

5. Assemble the bag by slipping the top straps on bag (M) over upper handle. Hook two small straps over stud pins on handle. Slip elastic opening of bag over air duct assembly. See figure 8.



Be certain elastic on bag is placed over the flanges on air duct assembly.

FIGURE 8.

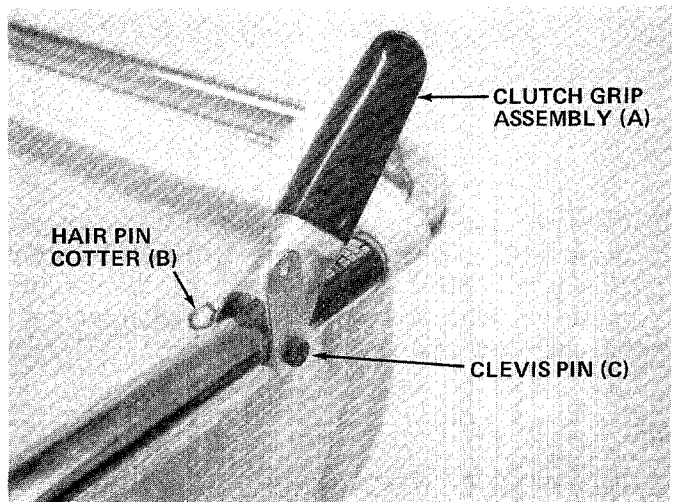

Steps 6, 7 and 8 are for self-propelled units only.

6. Assemble the clutch grip (A) to the left hand side of upper handle. Secure in place with clevis pin (C) and hair pin cotter (B). See figure 9. Head of clevis pin should be to the outside of handle.

FIGURE 9.

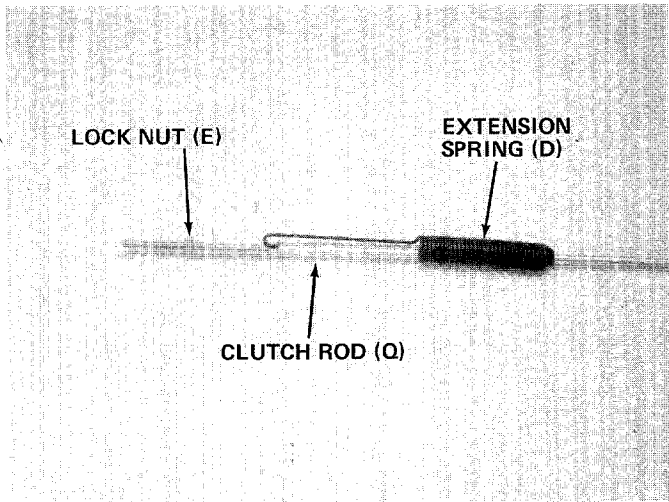

FIGURE 10.

7. Slide the extension spring (D) onto clutch rod (Q) as shown in figure 10. Thread lock nut (E) onto clutch rod approximately 2-1/2 inches.



FIGURE 11.

8. Hook top (hooked end) of clutch rod into clutch grip. Hook spring into clutch bracket assembly. See figure 11. Spring should not have any slack. Adjust nut so that when the clutch grip is all the way up, there is no slack in the spring.
9. Thread hex jam nut onto clutch rod, and lock it against the lock nut.

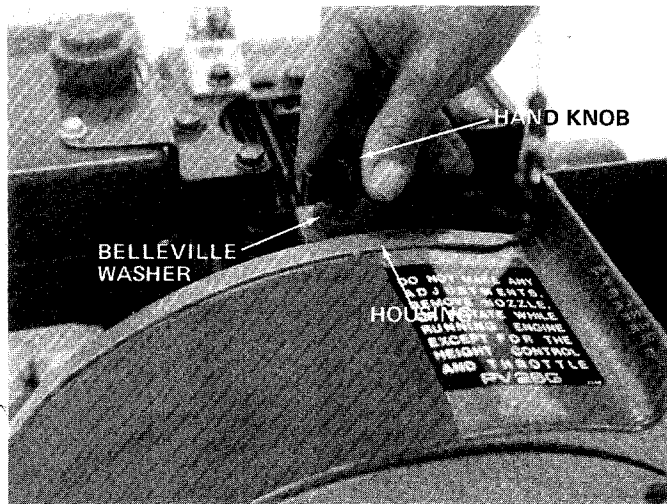

FIGURE 12.

ASSEMBLY INSTRUCTIONS

To Convert from a Vacuum to a Leaf Blower.



Engine must be stopped (off) and spark plug wire disconnected.

1. Remove the bag.
2. Remove the air duct assembly by removing two hand knobs and bellville washers.
3. Remove the nozzle by removing one hand knob and bellville washer.
4. Remove the hand knob and bellville washer holding the housing to engine brace. See figure 12.

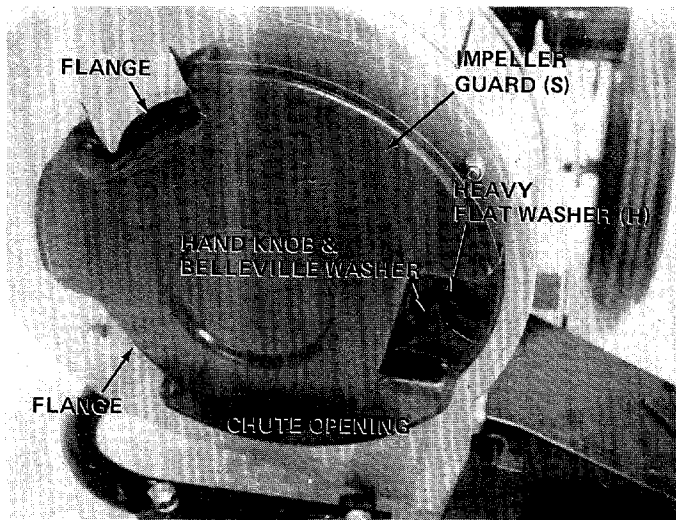

5. Lift up on the housing and rotate it 105° clockwise. Chute opening should be to the right hand side when viewed from the front of unit. See figure 13.
6. Place the impeller guard (S) into flanges on front of housing. Line up hole in screen with hole on housing. Secure with one hand knob, belleville washer and heavy flat washer (H). See figure 13.

FIGURE 13

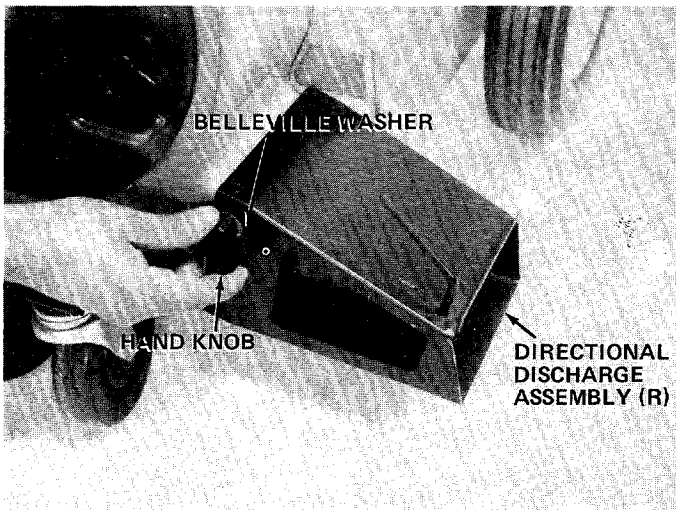

7. Place the directional discharge assembly (R) over chute opening. Secure with two hand knobs and belleville washers. See figure 14.

FIGURE 14

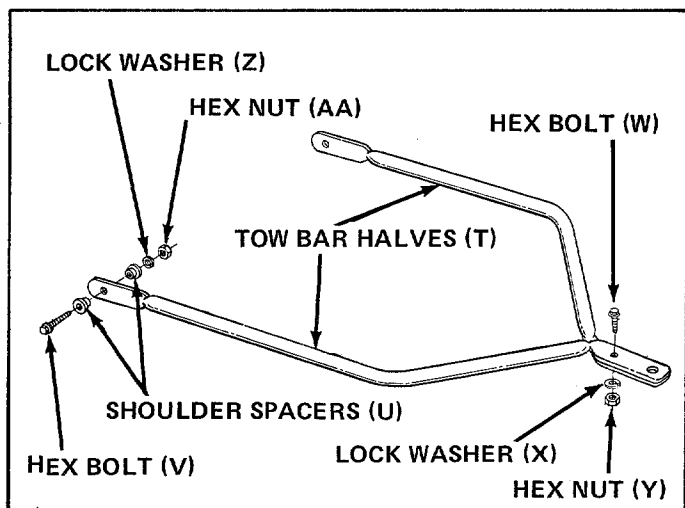

**ASSEMBLY INSTRUCTIONS
for Tow Bar Kit.**

1. Remove the self tapping screws on each side of frame. Refer to drawing on page 12, reference number 42.
2. Place tow bar half in position on frame. Place one shoulder spacer (U) between frame and tow bar. Next, place shoulder spacer (U) and hex bolt (V) through tow bar and frame. Secure with lock washer (Z) and hex nut (AA). See figure 15.
3. Secure the two tow bar ends together with hex bolt (W), lock washer (X) and hex nut (Y). See figure 15.

FIGURE 15

OPERATION

PRE-START PREPARATIONS

Service engine with gas and oil. See engine manual packed with vacuum for complete instructions for care and maintenance of engine. **READ DIRECTIONS CAREFULLY.**

CAUTION
REVOLVING BLADES-KEEP
HANDS AWAY FROM ALL
OPENINGS

3450

TO START ENGINE

After the engine has been properly fueled and oiled (refer to engine operating and maintenance instructions), start engine following the instructions below.

1. Move throttle control lever on engine to **START** position.
2. Crank engine. Pull recoil with quick firm pull. Do not pull out so far the rope stops with a jerk as this will cause rope failure. Do not allow rope and handle to snap back into place.
3. After two or three full firm pulls on recoil (or as soon as engine fires), move speed control to run position.
4. **Self Propelled Models Only** - To engage the drive mechanism, squeeze the clutch grip against the upper handle. Release the clutch grip to stop the forward motion.

TO STOP ENGINE

1. To stop engine, move throttle control lever to **STOP** position.
2. Disconnect spark plug wire and ground to prevent accidental starting while equipment is unattended.

Operate a new engine at intermediate speeds and light load for the first few hours as you would a new automotive engine.

ADJUSTMENTS



CAUTION

Do not at any time make any adjustment to the unit without first stopping engine and disconnecting spark plug wire.

HEIGHT ADJUSTMENT

To adjust the height of the nozzle, stand on the right hand side of vacuum and move the index handle towards the engine. Move handle towards rear of unit to lower height. Move the handle forward to raise the height. See figure 16.

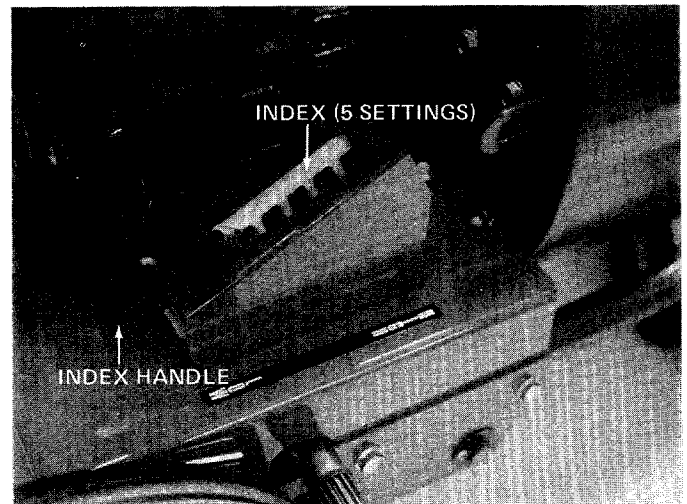

FIGURE 16

CARBURETOR ADJUSTMENT



WARNING

If any adjustments are made to the engine while the engine is running (e.g. carburetor), disengage all clutches. Keep clear of all moving parts. Be careful of heated surfaces and muffler.

If carburetor needs adjustment to start or for operation, see "Carburetor Adjustment" section of engine manual.

CLUTCH ROD ADJUSTMENT (Self Propelled Models Only)

To adjust the clutch rod, refer to step number 8 under assembly instructions.

LUBRICATION

Wheels - Rear wheels are provided with oil lite bearings. Place a few drops of SAE 30 oil on each bearing once a season.

Gear Box (Self Propelled Models Only) - The gear box lubricated with 2 ounces of High Temp. (450° F.) grease. Order part number 727-0120. Periodically check lubricant level by removing the two self-tapping screws on the gear box cover and lifting off the cover. Do not change grease; simply add if necessary.

MAINTENANCE



Disconnect spark plug wire and ground it against the engine before performing any repairs or maintenance.

BELT REPLACEMENT (Self Propelled Models Only)

1. Remove the nozzle or impeller guard from front of air duct housing.
2. Remove hex bolt and lock washer from center of impeller. See figure 17. A 9/16" socket wrench with extension is needed.
3. Remove hand knob and belleville washer from top of housing.
4. Remove two self-tapping screws which hold the belt guard. See figure 18. A 3/8" wrench is required. Lift off belt guard.
5. Slide belt off the impeller pulley. Slide housing and impeller off engine crankshaft. Be careful to not lose square key. See figure 19.

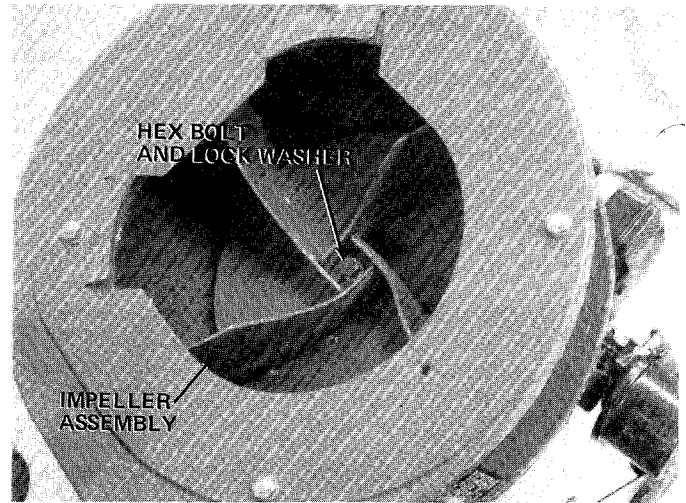

FIGURE 17



FIGURE 18

5. Slide belt off the impeller pulley. Slide housing and impeller off engine crankshaft. Be careful to not lose square key. See figure 19.

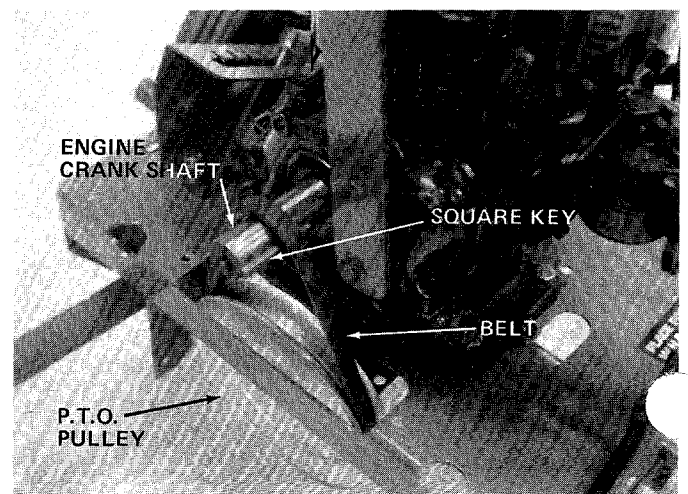

FIGURE 19

6. Slide belt off crank shaft.
7. Remove belt from P.T.O. pulley and install new belt. See figure 19.



When reassembling the new belt, the aid of another person will be helpful.

8. Turn the crankshaft until the key way on shaft is directly on top. While holding housing assembly and impeller assembly, line up the key way on the pulley with the key on the crankshaft, and slide housing and impeller assemblies onto crankshaft.
9. Secure impeller to crankshaft with hex bolt and lockwasher, removed in step 2. Tighten securely.
10. Slip belt over impeller pulley and reassemble the belt guard.
11. Reassemble the nozzle or impeller guard.

OFF-SEASON STORAGE

The following steps should be taken to prepare the unit for storage.

1. Clean the engine and the entire unit thoroughly.
2. Refer to engine manual for correct engine storage instructions.
3. Store unit in a clean, dry area.

Models 675, 685 and 689

IF YOU WRITE TO US ABOUT THIS ARTICLE
OR IF YOU ORDER REPLACEMENT PARTS AL-
WAYS MENTION THIS MODEL & SERIAL NO
MODEL

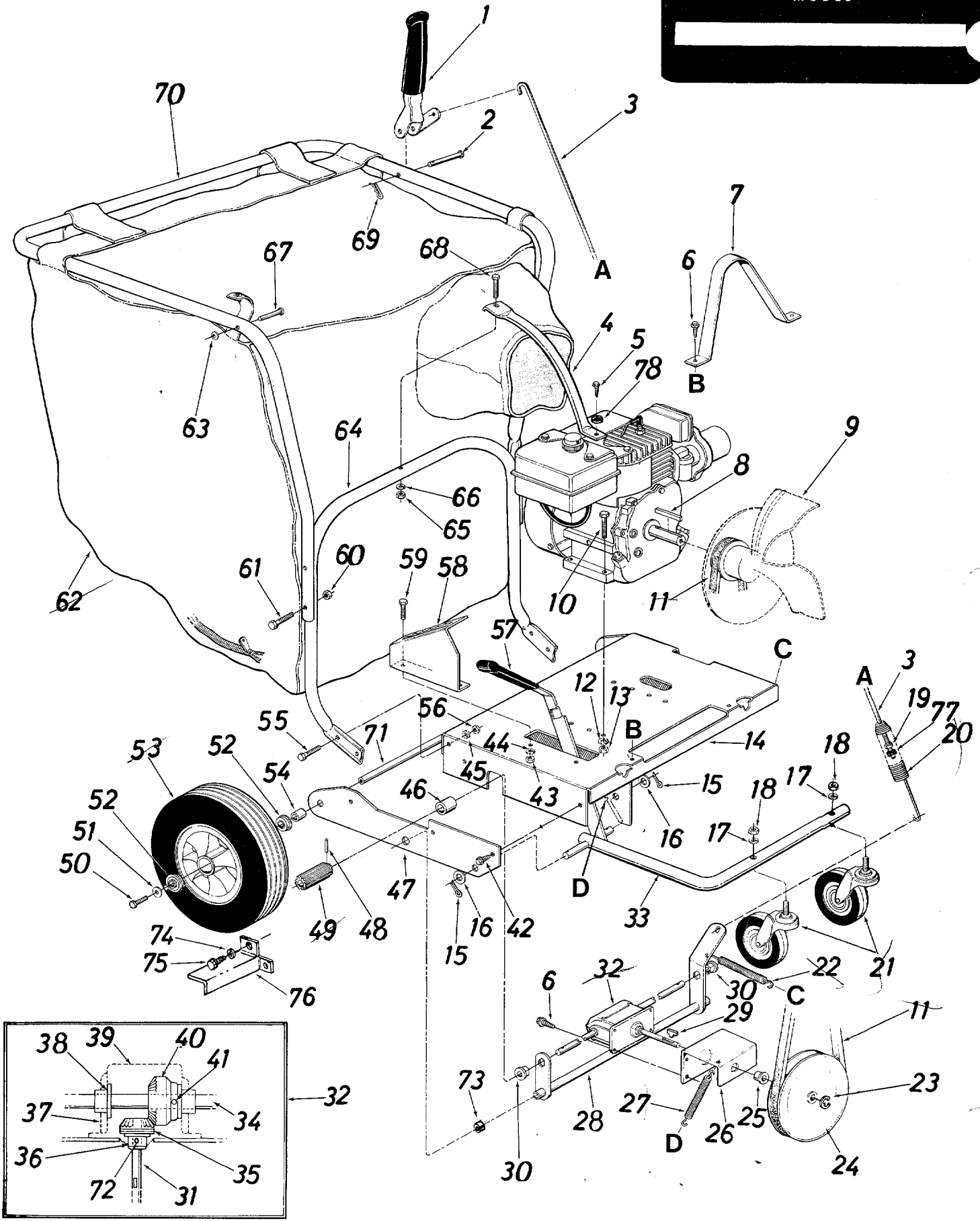

675/ 685/689

PARTS LIST FOR MODELS 675, 685, 689, 24677 and 24687 POWER VACUUMS

Ref. No.	Part No.	Color Code	DESCRIPTION	New Part	Ref. No.	Part No.	Color Code	DESCRIPTION	New Part
1	05778		Clutch Grip Ass'y. †		40	748-0135		Bevel Gear .62" I.D. x 28	
2	711-0679		Clevis Pin .375" Dia. x 1.88" Lg. †		41	715-0246		Teeth † Spring Pin Spirai 3/16" Dia. x 1.25" Lg. †	
3	747-0154		Clutch Rod 32" Lg. †		42	710-0726		Hex Wash. Hd. "AB" Tap Scr. 5/16" x .75" Lg.	
4	749-0482		Handle Brace (5 H.P.)		43	712-0267		Hex Nut 5/16-18 Thd.*	
	749-0484		Handle Brace (8 H.P.)		44	736-0119		L-Wash. 5/16" I.D.*	
5	-----		Part of Engine		45	736-0119		L-Wash. 5/16" I.D.*	
6	710-0776		Hex Wash. Hd. "AB" 1/4" x .62" Lg. †		46	748-0201		Spacer .63 I.D. x .88" O.D. x .56" Lg. †	
7	14558		Belt Guard †		47	14530 --- 488		Side Plate	
8	714-0114		Square Key 1/4" x 1/4" x 2.00" Lg.*		48	715-0139		Spring Pin Spiral 3/16" Dia. x .81" Lg. †	
9	14536 --- 488		Air Vane Plate Ass'y. (675 and 677)		49	748-0288		Drive Pinion †	
	14557 --- 488		Air Vane Plate Ass'y. w/pulley †		50	710-0170		Hex Locking Bolt 5/16-24 x .62" Lg.	
10	710-0442		Hex Bolt 5/16-18 x 1.50" Lg.*		51	736-0159		Fl.-Wash. .34" I.D. x 87" O.D.	
11	754-0219		"V"-Belt 1/2" x 26" Lg. †		52	-----		Ball Bearings - Part of Wheel Ass'y. (Ref. 53)	
12	736-0119		L-Wash. 5/16" I.D.*		53	734-1035		Wheel Ass'y. - Comp. 12" x 3"	
13	712-0267		Hex Nut 5/16-18 Thd.*		54	750-0194		Spacer .63" I.D. x 1.00" O.D. x .94" Lg.	
14	14527 --- 488		Engine Mounting Frame Ass'y.		55	710-0118		Hex Bolt 5/16-18 x .75" Lg.*	
15	1544-019		Cotter Pin 5/32" Dia. x 1.25" Lg.*		56	712-0267		Hex Nut 5/16-18 Thd.*	
16	736-0187		Fl.-Wash. .63+ I.D. x 1.25" O.D.		57	720-0142		Flat Grip Vinyl	
17	736-0921		L-Wash. 1/2" I.D.*		58	14561		Index Plate	
18	712-0206		Hex Nut 1/2-13 Thd.*		59	710-0118		Hex Bolt 5/16-18 x .75" Lg.*	
19	712-0107		Hex Cent. L.-Nut 1/2" I.D.		60	712-0107		Hex Cent. L.-Nut 1/4-20 Thd.	
20	732-0411		Extension Spring .78" O.D. x 7.50" Lg. †		61	710-0136		Hex Bolt 1/4-20 x 1.75" Lg.	
21	734-1036		Swivel Caster Wheel 5" Dia. x 1.25"		62	764-0162		Vacuum Bag - Felt	
22	732-0409		Extension Spring .38" O.D. x 3.18" Lg. †		63	1539-019		Push Speed Nut for .25" Dia. Stud	
23	716-0104		Snap "E"-Ring .50" Dia. Shaft †		64	749-0481		Lower Handle	
24	756-0367		"V"-Pulley 5/8" x 6.50" O.D. †		65	712-0287		Hex Nut 1/4-20 Thd.*	
25	748-0142		Flange Bearing .502" I.D. †		66	736-0329		L-Wash. 1/4" I.D.*	
26	14570		Gear Box Mounting Bracket †		67	711-0737		Stud Pin .250" Dia. x 1.75" Lg.	
27	732-0376		Extension Spring .75" O.D. x 3.28" Lg. †		68	710-0136		Hex Bolt 1/4-20 x 1.75" Lg.*	
28	14565		Clutch Bracket Ass'y. †		69	714-0145		Internal Cotter Pin 3/8" Dia.	
29	714-0229		#2 Woodruff Key 3/32" Dia. x .81" Lg. †		70	749-0480		Upper Handle	
30	748-0227		Hex Flange Bearing Bronze .625" I.D. †		71	738-0185		Rear Axle .624" Dia. x 24.37" Lg.	
31	738-0516		Pinion Shaft .50" Dia. x 5.0" Lg. †		72	715-0249		Spring Roll Pin 5/32" Dia. x 1.12 †	
32	717-0493		Gear Box Ass'y. Comp. †		73	750-0142		Spacer .82" I.D. x 1.00" O.D. x .305" Lg. †	
33	14571 --- 488		Caster Arm Ass'y.		74	736-0175		L-Wash. .265" I.D. †	
34	08348		Drive Shaft .624" Dia. x 22.75" Lg. †		75	710-0352		Hex Self Tap Scr. 1/4" x 3/8" Lg. †	
35	748-0136		Bevel Gear .50" I.D. x 14 Teeth †		76	14556		R.H. Pinion Guard †	
36	748-0108		Flange Bearing .503" I.D. †			14555		L.H. Pinion Guard (Not Shown)	
37	08189		Gear Box †		77	712-0298		Hex Jam Nut 1/4-20 Thd. †	
38	748-0110		Flange Bearing .630" I.D. †		78	736-0242		Belleville Washer	
39	08187		Gear Box Cover †						

Models 675, 685 and 689

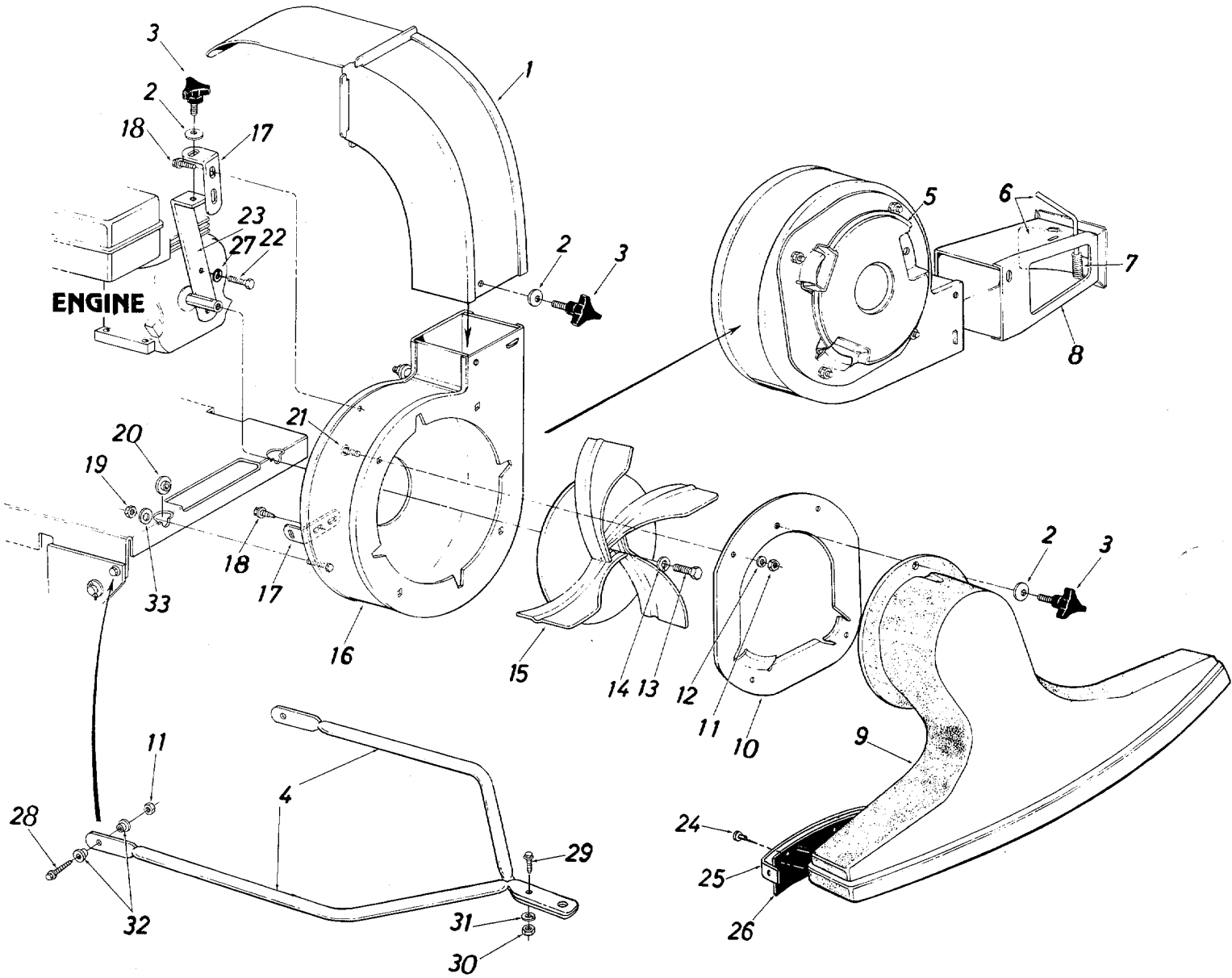

Models 675, 685 and 689

PARTS LIST FOR MODELS 675, 685, 689, 24677 and 24687 POWER VACUUMS

Ref. No.	PART No.	COLOR CODE	DESCRIPTION	New Part
1	14532 --- 488		Air Duct Assembly	
2	736-0242		Belleville Wash. .34" I.D. x .87" O.D.	
3	720-0170		3-Arm Thumb Scr. 5/16-18 x .75" Lg.	
4	749-0501		Tow Bar Half	N
5	731-0608		Blower Guard	N
6	14549		Door Assembly	
7	732-0335		Compression Spring	
8	14479		Directional Discharge Ass'y. (Includes Ref. No. 6 & 7)	N
9	14562		Nozzle Ass'y.	
10	14563		Nozzle Plate Ass'y.	
11	712-0267		Hex Nut 5/16-18 Thd.*	
12	736-0119		L.-Wash. 5/16" I.D.	
13	710-0191		Hex Bolt 3/8-24 x 1.25" Lg.*	
14	736-0217		L.-Wash. 3/8" I.D. H.D.	
15	14536 --- 488		Air Vane Plate Ass'y. (675 and 24677)	
	14557 --- 488		Air Vane Plate Ass'y. w/pulley (685, 689 and 24687)	
16	14496 --- 488		Blower Housing Complete	N
17	14541		Right Angle Bracket	
18	710-0600		Hex Wash. Hd. Self Tap Scr. 5/16-18 x .50" Lg.	
19	712-0158		Hex Cent. L.-Nut 5/16-18 Thd.	
20	736-0289		Shoulder Spacer .50" I.D. x .135	
21	710-0260		Carriage Bolt 5/16-18 x .62" Lg.*	
22	710-0627		Hex Locking Bolt 5/16-24 x .75" Lg.	
23	14539		Housing - Engine Brace Ass'y.	
24	728-0143		Pop Rivet (5-Required)	
25	14569		Wiper Retaining Strip	
26	735-0214		Nozzle Wiper	
27	736-0271		L.-Wash. 5/16" I.D.	
28	710-0602		Hex Bolt 5/16-18 x 1.00" Lg.*	
29	710-0255		Truss Mach. Scr. 1/4-20 x .75" Lg.*	
30	712-0287		Hex Nut 1/4-20 Thd.*	
31	736-0329		L.-Wash. 1/4" I.D.*	
32	748-0234		Shoulder Spacer	
33	736-0101		Flat Wash. .41 I.D. x 1.0 O.D.	

*For faster service obtain standard nuts, bolts and washers locally. If these items cannot be obtained locally, order by part number and size as shown on parts list.

(488 - Mack Truck Yellow)
(497 - Yard-Man Red)

When ordering parts, if color or finish is important use the appropriate color code shown above. (e.g. Mack Truck Yellow Finish—14542 (488).)

NOTE: The engine is not under warranty by the vacuum manufacturer...If repairs or service is needed on the engine, please contact your nearest authorized engine service outlet. Check the "Yellow Pages" of your telephone book under "Engines—Gasoline."



NOTE

This instruction manual covers various models and all specifications shown do not necessarily apply to your model. Specifications subject to change without notice or obligation.

PARTS INFORMATION

POWER EQUIPMENT PARTS AND SERVICE

Parts and service for all MTD manufactured power equipment are available through the authorized service firms listed below. All orders should specify the model number of your unit, part numbers, description of parts and the quantity of each part required.

BRIGGS AND STRATTON, TECUMSEH AND PEERLESS PARTS AND SERVICE

Briggs & Stratton, Tecumseh and Peerless parts and service should be handled by your nearest authorized engine service firm. Check the yellow pages of your telephone directory under listing **Engines—Gasoline, Briggs & Stratton or Tecumseh**. Lauson.

NOTE: If any parts are found to be missing or defective upon assembly of this unit, write to advise the factory so that immediate replacement can be made.

ALABAMA	BIRMINGHAM
Auto Electric & Carburetor Co.	2625 4th Ave. S. 35233
ARKANSAS	NORTH LITTLE ROCK
Sutton's Lawn Mower Shop	5301 Roundtop Drive
	Box 368, Rt. 4 72117
CALIFORNIA	PORTERVILLE
Billious	75 North D Street 93257
COLORADO	DENVER
Spitzer Industrial Products Co.	Box 29114, 6601
	N. Washington St. 80229
FLORIDA	JACKSONVILLE
Radco Distributors	4909 Victor St.
	Box 5459 32207
	OPA LOCKA
Small Eng. Dist.	2351 N.W. 147th St. 33054
GEORGIA	EAST POINT
East Point Cycle & Key	2834 Church St. 30344
ILLINOIS	LYONS
Keen Edge Co.	8615 Ogden Ave. 60534
INDIANA	ELKHART
Parts & Sales Inc.	2101 Industrial Pkwy. 46514
IOWA	DUBUQUE
Power Lawn & Garden Equip.	2551 J.F. Kennedy 52001
LOUISIANA	MONROE
Mid-South Power	700 Pine St. 71201
	NEW ORLEANS
Suhren Engine Co.	8330 Earhart Blvd. 70118
MARYLAND	TAKOMA PARK
Center Supply Co.	6867 New Hampshire
	Ave. 20912
MASSACHUSETTS	SPRINGFIELD
Morton B. Collins Co.	300 Birnie Ave. 01107
MICHIGAN	LANSING
Lorenz Service Co.	2500 S. Pennsylvania 48910
	MOUNT CLEMENS
Power Equipment Dist.	340 Hubbard 48043
MINNESOTA	HOPKINS
Hance Distributing Inc.	420 Excelsior Ave. W. 55343
MISSISSIPPI	BILOXI
Biloxi Sales & Service, Inc.	506 Caillavet St. 39533
MISSOURI	KANSAS CITY
Automotive Equip. Service	3117 Holmes St. 64109
	ST. JOSEPH
Ross-Frazier Supply Co.	8th and Monterey 64503
	ST. LOUIS
Henzler, Inc.	2015 Lemay Ferry
	Road 63125
NEW JERSEY	BELLMAWR
Lawnmower Parts Inc.	717 Creek Rd. 08030
NEW MEXICO	ALBUQUERQUE
Spitzer Eng. & Parts	1023 Third Ave. N.W. 87103

NEW YORK	CARTHAGE
Gamble Dist., Inc.	West End Ave. 13619
NORTH CAROLINA	GOLDSBORO
Smith Hardware Co.	515 N. George St. 27530
	GREENSBORO
Dixie Sales Company	335 N. Green 27402
OHIO	CARROLL
Stebe's Mid-State Mower Supply	Box 366, 71 High St. 43112
	CLEVELAND
Bleckrie, Inc.	7900 Lorain Ave. 44102
	WADSWORTH
National Central	687 Seville Rd. 44281
	YOUNGSTOWN
Burton Supply Co.	1301 Logan Ave.
	Box 929 44501
OKLAHOMA	MUSKOGEE
Victory Motors, Inc.	605 S. Cherokee 74401
OREGON	PORTLAND
Kenton Supply Co.	8216 N. Denver Ave. 97217
PENNSYLVANIA	HARRISBURG
EECO Inc.	4021 N. 6th St. 17110
	PHILADELPHIA
Thompson Rubber Co.	5222-24 N. Fifth St. 19120
	PITTSBURGH
Bluemont Co.	11125 Frankstown Rd. 15235
	PUNXSUTAWNEY
Frank Roberts & Sons	R.D. 2 15767
TENNESSEE	KNOXVILLE
Master Repair Service	2000 Western Ave. 37977
	MEMPHIS
American Sales & Service, Inc.	3035-43 Bellbrook 38116
TEXAS	DALLAS
Marr Brothers, Inc.	423 E. Jefferson 75203
	FORT WORTH
Woodson Sales Corp.	1702 N. Sylvania 76111
	HOUSTON
Bullard Supply Co.	2409 Commerce St. 77003
	SAN ANTONIO
Engine House Inc.	8610 Botts Lane
	P.O. Box 17867 78217
UTAH	SALT LAKE CITY
A-1 Engine & Mower Co.	439 E. 900 So. 84111
VIRGINIA	ASHLAND
RBI Corp.	Lake Ridge Rd.
	101 Cedar Run Dr. 23005
WASHINGTON	SEATTLE
Bailey's Inc.	1414 14th Ave. 98122
WISCONSIN	MARSHFIELD
Power Pac	301 E. 29th St. 54449

WARRANTY PARTS AND SERVICE POLICY

(0382)

The purpose of warranty is to protect the customer from defects in workmanship and materials, defects which are NOT detected at the time of manufacture. It does not provide for the unlimited and unrestricted replacement of parts. Use and maintenance are the responsibility of the customer. The manufacturer cannot assume responsibility for conditions over which it has no control. Simply put, if it's the manufacturer's fault, it's the manufacturer's responsibility; if it's the customer's fault, it's the customer's responsibility.

CLAIMS AGAINST THE MANUFACTURER'S WARRANTY INCLUDES:

1. Replacement of Missing Parts on new equipment.
2. Replacement of Defective Parts within the warranty period.
3. Repair of Defects within the warranty period.

All claims MUST be substantiated with the following information:

1. Model Number of unit involved.
2. Date unit was purchased or first put into service.
3. Date of failure.
4. Nature of failure.