

Kawasaki Z800 Owner's Manual



Z800
Z800 ABS

Motorcycle

OWNER'S MANUAL

<http://www.motorcycle.in.th>

Quick Reference Guide

This Quick Reference Guide will assist you in finding the information you're looking for.

SAFETY INFORMATION

GENERAL INFORMATION

HOW TO RIDE THE MOTORCYCLE

MAINTENANCE AND ADJUSTMENT

APPENDIX

MAINTENANCE RECORD

A Table of Contents is included after the Foreword.

Whenever you see the symbols shown below, heed their instructions! Always follow safe operating and maintenance practices.

 **DANGER**

DANGER indicates a hazardous situation which, if not avoided, will result in death or serious injury.

 **WARNING**

WARNING indicates a hazardous situation which, if not avoided, could result in death or serious injury.

NOTICE

NOTICE is used to address practices not related to personal injury.

NOTE

- *This note symbol indicates points of particular interest for more efficient and convenient operation.*

NOTICE

THIS PRODUCT HAS BEEN MANUFACTURED FOR USE IN A REASONABLE AND PRUDENT MANNER BY A QUALIFIED OPERATOR AND AS A VEHICLE ONLY.

Foreword

Congratulations on your purchase of a new Kawasaki motorcycle. Your new motorcycle is the product of Kawasaki's advanced engineering, exhaustive testing, and continuous striving for superior reliability, safety and performance.

Please read this Owner's Manual carefully before riding so that you will be thoroughly familiar with the proper operation of your motorcycle's controls, its features, capabilities, and limitations. This manual offers many safe riding tips, but its purpose is not to provide instruction in all the techniques and skills required to ride a motorcycle safely. Kawasaki strongly recommends that all operators of this vehicle enroll in a motorcycle rider training program to attain awareness of the mental and physical requirements necessary for safe motorcycle operation.

To ensure a long, trouble-free life for your motorcycle, give it the proper care and maintenance described in this manual. For those who would like more detailed information on their Kawasaki Motorcycle, a Service Manual is available for purchase from any authorized Kawasaki motorcycle dealer. The Service Manual contains detailed disassembly and maintenance information. Those who plan to do their own work should, of course, be competent mechanics and possess the special tools described in the Service Manual.

Keep this Owner's Manual aboard your motorcycle at all times so that you can refer to it whenever you need information.

This manual should be considered a permanent part of the motorcycle and should remain with the motorcycle when it is sold.

All rights reserved. No part of this publication may be reproduced without our prior written permission.

This publication includes the latest information available at the time of printing. However, there may be minor differences between the actual product and illustrations and text in this manual.

All products are subject to change without prior notice or obligation.

KAWASAKI HEAVY INDUSTRIES, LTD.
Motorcycle & Engine Company

© 2012 Kawasaki Heavy Industries, Ltd.

Jul. 2012. (2)

(Australian model only)

TAMPERING WITH NOISE CONTROL SYSTEM PROHIBITED

Owners are warned that the law may prohibit:

- (a) The removal or rendering inoperative by any person other than for purposes of maintenance, repair or replacement, of any device or element of design incorporated into any new vehicle for the purpose of noise control prior to its sale or delivery to the ultimate purchaser or while it is in use; and
- (b) The use of the vehicle after such device or element of design has been removed or rendered inoperative by any person.

TABLE OF CONTENTS

SAFETY INFORMATION	10	GENERAL INFORMATION	21
Read Owner's Manual	10	Specifications	21
Training	10	Serial Number Locations	25
Daily Safety Checks and Periodic Maintenance	10	Location of Labels	26
Loading and Accessories Information	11	Location of Parts	33
Passenger	12	Meter Instruments	36
Baggage and Luggage	13	Tachometer	37
Accessories	13	Multifunction Meter (Right Side) ...	39
Other Load	14	Multifunction Meter (Left Side)	46
If You are Involved in an Accident ...	14	Indicator Lights	52
Safe Operation	15	Warning Indicator Lights	53
Carbon Monoxide Hazard	15	Keys	56
Fueling	16	Ignition Switch/Steering Lock	59
Never Ride with Drugs or Alcohol.	16	Right Handlebar Switches	60
Protective Gear and Clothing	16	Left Handlebar Switches	61
Safe Riding Techniques	17	Brake Lever Adjuster	62
Additional Considerations for High Speed Operation	19	Fuel Tank Cap	63
		Fuel	64
		Fuel Requirements	64
		Filling the Tank	66

Side Stand	68	Coolant.....	106
Seats	69	Air Cleaner	111
Tying Hooks	72	Throttle Control System	112
Tool Kit	72	Idle Speed.....	114
Rear View Mirror	73	Clutch.....	115
Event Data Recorder.....	75	Drive Chain	117
HOW TO RIDE THE MOTORCYCLE ..	76	Brakes.....	121
Break-In	76	Brake Light Switches.....	124
Starting the Engine	77	Suspension System	125
Jump Starting.....	79	Front Fork.....	125
Moving Off.....	82	Rear Shock Absorber	127
Shifting Gears	83	Setting Tables	129
Braking.....	84	Wheels	132
Anti-lock Brake System (ABS)	85	Battery.....	135
Yellow ABS Indicator Light.....	87	Headlight.....	139
Stopping the Engine.....	88	Fuses	141
Stopping the Motorcycle in an		General Lubrication.....	142
Emergency	88	Cleaning Your Motorcycle	144
Parking.....	89	General Precautions	144
MAINTENANCE AND ADJUSTMENT ..	92	Washing Your Motorcycle	145
Daily Safety Checks	94	APPENDIX	150
Periodic Maintenance.....	97	Storage	150
Engine Oil	102	Troubleshooting Guide.....	153

Owner Satisfaction	154	MAINTENANCE RECORD	157
Environmental Protection.....	156		

SAFETY INFORMATION

Read Owner's Manual

Read this Owner's Manual carefully before riding so that you will be thoroughly familiar with the proper operation of your motorcycle's controls, its features, capabilities, and limitations. This manual offers many safe riding tips, but its purpose is not to provide instruction in all of the techniques and skills required to ride a motorcycle safely.

Training

Kawasaki strongly recommends that all operators of this vehicle complete a suitable motorcycle rider training program to learn the proper skills and techniques necessary for safe motorcycle operation.

Daily Safety Checks and Periodic Maintenance

It is important to keep your motorcycle properly maintained and in safe riding condition. Inspect your motorcycle before every ride and carry out all periodic maintenance. See the Daily Safety Checks section and the Periodic Maintenance section in the MAINTENANCE AND ADJUSTMENT chapter for more information.

WARNING

Failure to perform these checks or to correct a problem before operation may result in serious damage or an accident. Always perform daily safety checks before operation.

To ensure your motorcycle is serviced using the latest servicing information, it is recommended that an authorized Kawasaki Dealer performs the periodic maintenance as directed in the Owner's Manual.

If you notice any irregular operating condition, have your motorcycle thoroughly checked at an authorized Kawasaki dealer as soon as possible.

Loading and Accessories Information

WARNING

Incorrect loading, improper installation or use of accessories or modification of your motorcycle may result in an unsafe riding condition. Before you ride the motorcycle, make sure it is not overloaded and that you have followed these instructions.

Maximum Load

Weight of rider, passenger, baggage, and accessories must not exceed 180 kg (397 lb).

With the exception of genuine Kawasaki Parts and Accessories, Kawasaki has no control over the design or application of accessories. In some cases, improper installation

12 SAFETY INFORMATION

or use of accessories, or motorcycle modification, will void the motorcycle warranty; can negatively affect performance, stability and safety; and can even be illegal.

In selecting and using accessories, and in loading the motorcycle, you are personally responsible for your own safety and the safety of other persons involved.

NOTE

○ *Kawasaki Parts and Accessories have been specially designed for use on Kawasaki motorcycles. We strongly recommend that all parts and accessories you add to your motorcycle be genuine Kawasaki components.*

Because a motorcycle is sensitive to changes in weight and aerodynamic forces, you must take extreme care in carrying cargo, passengers and/or in

fitting additional accessories. The following general guidelines have been prepared to assist you in making your determinations.

Passenger

1. Never carry more than one passenger.
2. The passenger should only sit on the pillion.
3. Any passenger should be thoroughly familiar with motorcycle operation. The passenger can affect control of the motorcycle by improper positioning during cornering and sudden movements. It is important that the passenger sits still while the motorcycle is in motion and not interfere with the operation of the motorcycle. Do not carry animals on your motorcycle.

4. Do not carry passengers unless passenger footpegs are installed. Instruct any passenger before riding to keep his or her feet on the passenger footpegs and hold on to the operator or seat strap. Do not carry a passenger unless he or she is tall enough to reach the footpegs with their feet.

Baggage and Luggage

1. All baggage should be carried as low as possible to reduce the effect on the motorcycle's center of gravity. Baggage weight should also be distributed equally on both sides of the motorcycle. Avoid carrying baggage that extends beyond the rear of the motorcycle.
2. Baggage should be securely attached. Make sure that the baggage

will not move around while you are riding. Recheck baggage security as often as possible (not while the motorcycle is in motion) and adjust as necessary.

3. Do not carry heavy or bulky items on a luggage rack. It is designed for light items, and overloading can affect handling due to changes in weight distribution and aerodynamic forces.

Accessories

1. Do not install accessories or carry baggage that impairs the performance of the motorcycle. Make sure that you have not adversely affected any lighting components, road clearance, banking capability (i.e., lean angle), control operation, wheel travel, front fork movement,

14 SAFETY INFORMATION

- or any other aspects of the motorcycle's operation.
2. Weight attached to the handlebar or front fork will increase the mass of the steering assembly and can result in an unsafe riding condition.
 3. Fairings, windshields, backrests, and other large items have the capability of adversely affecting stability and handling of the motorcycle, not only due to their weight, but also due to the aerodynamic force acting on these surfaces while the motorcycle is in operation. Poorly designed or installed items can result in an unsafe riding condition.

Other Load

1. This motorcycle is not intended to be equipped with a sidecar or to be

- used to tow any trailers or other vehicles. Kawasaki does not manufacture sidecars or trailers for motorcycles and cannot predict the effects of such accessories on handling or stability, but can only warn that the effects can be adverse and that Kawasaki cannot assume responsibility for the results of such unintended use of the motorcycle.
2. Furthermore, any adverse effects on motorcycle components caused by the use of such accessories will not be remedied under warranty.

If You are Involved in an Accident

Make sure of your own safety first. Determine the severity of any injuries and call for emergency assistance if needed. Always follow applicable laws

and regulations if any other person, vehicle or property is involved.

Do not attempt to continue riding without first evaluating your motorcycle's condition. Inspect for fluid leaks, check critical nuts and bolts, and check the handlebars, control levers, brakes, and wheels for damage and proper function. Ride slowly and cautiously - your motorcycle may have suffered damage that is not immediately apparent. Have your motorcycle thoroughly checked at a Kawasaki dealer as soon as possible.

Safe Operation

The following should be carefully observed for safe and effective vehicle operation.

Carbon Monoxide Hazard

DANGER

Exhaust gas contains carbon monoxide, a colorless, odorless poisonous gas. Inhaling carbon monoxide can cause serious brain injury or death.

Do not run the engine in enclosed areas. Operate only in a well-ventilated area.

Fueling

 **WARNING**

Gasoline is extremely flammable and can be explosive under certain conditions.

To avoid a possible fire or explosion, turn the ignition switch to "OFF." Do not smoke. Make sure the area is well ventilated and free from any source of flame or sparks; this includes any appliance with a pilot light.

Never Ride with Drugs or Alcohol

Alcohol and drugs impair your judgment and reaction time. Never consume alcohol or drugs before or while riding motorcycles.

Protective Gear and Clothing

Helmet

Kawasaki strongly recommends both the operator and passenger wear a helmet even if this is not a legal requirement.

- Make sure that your helmet fits correctly and is properly fastened.
- Choose a motorcycle helmet that meets the safety standards applicable to your country. Ask your motorcycle dealer to advise you if necessary.

Eye Protection

Always use eye protection. If your helmet does not have a visor installed, wear goggles.

Gloves

Wear gloves which have suitable protection for your hands, especially against abrasion.

Clothing

Wear protective clothing.

- Wear bright, highly visible clothing that allows freedom of movement to suit your riding style.
- Always wear a long-sleeved jacket and long trousers which are abrasion resistant and keep you warm.
- Avoid wearing clothes which have loose cuffs or other fastenings which could interfere with the controls of your motorcycle.

Boots

Wear proper protective boots that fit properly and do not interfere with gear shifting or braking.

Safe Riding Techniques

Keep Hands on Handlebars

When riding always keep both hands on the handlebars and both feet on the footpegs. Removing your hands from the handlebars or feet from the footpegs while riding can be hazardous. If you remove even one hand or foot, you reduce your ability to control the motorcycle.

Look Over Your Shoulder

Before changing lanes, look over your shoulder to make sure the way is clear. Do not rely solely on the rear

18 SAFETY INFORMATION

view mirror; you may misjudge a vehicle's distance and speed, or you may not see it at all.

Accelerate and Brake Smoothly

In general your actions should be smooth as sudden acceleration, braking or turning may cause loss of control, especially when riding in wet conditions or on loose road surfaces, when the ability to maneuver will be reduced.

Select Correct Gear Speeds

When going up steep slopes, shift to a lower gear so that there is power to spare rather than overloading the engine.

Use Both Front and Rear Brakes

When applying the brakes, use both the front and rear brakes. Applying only one brake for sudden braking may cause the motorcycle to skid and lose control.

Use Engine Brake

When going down long slopes, help control vehicle speed by closing the throttle so that the engine can act as an auxiliary brake. Use the front and rear brakes for primary braking.

Riding in Wet Conditions

Rely more on the throttle to control vehicle speed and less on the front and rear brakes. The throttle should also be used judiciously to avoid skidding the rear wheel from too rapid acceleration or deceleration.

Braking performance is also reduced in wet conditions. Carefully ride at a slow speed and apply the brakes several times to help dry and restores them to normal operating performance.

Lubricate the drive chain after wet-weather riding to prevent rust and corrosion.

Ride Prudently

Riding at the proper speed and avoiding unnecessarily fast acceleration are important not only for safety and low fuel consumption but also for long vehicle life and quieter operation.

Riding on Rough Roads

Exercise caution, slow down, and grip the fuel tank with the knees for better stability.

Acceleration

When quick acceleration is necessary to pass another vehicle, shift to a lower gear to obtain the necessary power.

Downshifting

To avoid engine damage and rear wheel lock-up do not downshift at high rpm.

Avoid Unnecessary Weaving

Unnecessary weaving jeopardizes the safety of both the rider and other motorists.

Additional Considerations for High Speed Operation

WARNING

Handling characteristics of a motorcycle at high speeds may vary from those you are familiar with at legal highway speeds. Do not attempt high speed operation unless you have received sufficient training and have the required skills.

Do not operate at high speeds on public roads.

20 SAFETY INFORMATION

Brakes

The importance of the brakes, especially during high speed operation, cannot be overemphasized. Check to see that they are correctly adjusted and functioning properly.

Steering

Looseness in the steering can cause loss of control. Check to see that the handlebar turns freely but has no play.

Tires

High speed operation is hard on tires, and good tires are crucial for safe riding. Examine their overall condition, inflate them to the proper pressure, and check the wheel balance.

Fuel

Have sufficient fuel for the high fuel consumption during high speed operation.

Engine Oil

To avoid engine seizure and resulting loss of control, make sure that the oil level is at the upper level line.

Coolant

To avoid overheating, check that the coolant level is at the upper level line.

Electrical Equipment

Make sure that the headlight, tail/brake light, turn signals, horn, etc., all work properly.

Miscellaneous

Make sure that all nuts and bolts are tight and that all safety related parts are in good condition.

GENERAL INFORMATION

Specifications

PERFORMANCE

Maximum Horsepower	83.0 kW (113 PS) @10 200 r/min (rpm)
Maximum Torque	83.0 N·m (8.5 kgf·m, 61 ft·lb) @8 000 r/min (rpm)
Minimum Turning Radius	3 m (118 in.)

DIMENSIONS

Overall Length	2 100 mm (82.7 in.)
Overall Width	800 mm (31.5 in.)
Overall Height	1 050 mm (41.3 in.)
Wheelbase	1 445 mm (56.9 in.)
Road Clearance	150 mm (5.91 in.)
Curb Mass	(ZR800A) 229 kg (505 lb)
	(ZR800B) 231 kg (509 lb)

ENGINE

Type	DOHC, 4-cylinder, 4-stroke, liquid-cooled
------	---

<http://www.motorcycle.in.th>

22 GENERAL INFORMATION

Displacement		806 cm ³ (49.2 cu in.)
Bore x Stroke		71.0 x 50.9 mm (2.8 x 2.0 in.)
Compression Ratio		11.9 : 1
Starting System		Electric starter
Cylinder Numbering Method		Left to right, 1-2-3-4
Firing Order		1-2-4-3
Fuel System		FI (Fuel Injection)
Ignition System		Battery and coil (transistorized ignition)
Ignition Timing (Electronically advanced)		10° BTDC @1 100 r/min (rpm) ~ 37° BTDC @5 000 r/min (rpm)
Spark Plugs	Type	NGK CR9EK, ND U27ETR
	Gap	0.7 ~ 0.8 mm (0.028 ~ 0.031 in.)
Lubrication System		Forced lubrication (wet sump)
Engine Oil:	Type	API SG, SH, SJ, SL, or SM with JASO MA, MA1 or MA2
	Viscosity	SAE 10W-40
	Capacity	3.8 L (4.0 US qt)
Coolant Capacity		2.8 L (3.0 US qt)

TRANSMISSION

Transmission Type	6-speed, return shift
Clutch Type	Wet, multi disc
Driving System	Chain drive
Primary Reduction Ratio	1.714 (84/49)
Final Reduction Ratio	3.000 (45/15)
Overall Drive Ratio	5.633 (Top gear)
Gear Ratio:	
1st	2.571 (36/14)
2nd	1.941 (33/17)
3rd	1.556 (28/18)
4th	1.333 (28/21)
5th	1.200 (24/20)
6th	1.095 (23/21)

FRAME

Castor	24°
Trail	98 mm (3.9 in.)

24 GENERAL INFORMATION

Tire Size:	Front	120/70ZR17 M/C (58W)
	Rear	180/55ZR17 M/C (73W)
Rim Size:	Front	J17M/C × MT3.50
	Rear	J17M/C × MT5.50
Fuel Tank Capacity		17 L (4.5 US gal)
Brake Fluid		DOT4

ELECTRICAL EQUIPMENT

Battery		12 V 8 Ah
Headlight:	High Beam	12 V 55 W (× 2)
	Low Beam	12 V 55 W
Tail/Brake Light		LED

Even if one of LED (Light Emitting Diode) tail/brake light does not go on, consult with an authorized Kawasaki dealer.

Specifications are subject to change without notice, and may not apply to every country.

Serial Number Locations

The engine and frame serial numbers are used to register the motorcycle. They are the only means of identifying your particular machine from others of the same model type. These serial numbers may be needed by your dealer when ordering parts. In the event of theft, the investigating authorities will require both numbers as well as the model type and any peculiar features of your machine that can help them identify it.

Engine No.

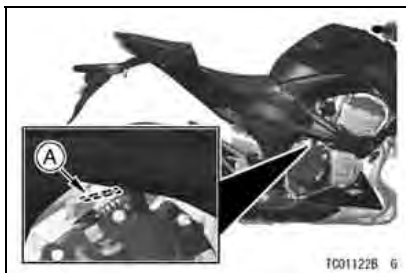

A. Engine Number

Frame No.



A. Frame Number

26 GENERAL INFORMATION

Location of Labels

All warning labels which are on your vehicle are repeated here. Read labels on your vehicle and understand them thoroughly. They contain information which is important for your safety and the safety of anyone else who may operate your vehicle. Therefore, it is very important that all warning labels be on your vehicle in the locations shown. If any label is missing, damaged, or worn, get a replacement from your Kawasaki dealer and install it in the correct position.

NOTE

- *The sample warning labels in this section have part numbers to help*

you and your dealer obtain the correct replacement.

- *Refer to the actual vehicle label for model specific data grayed out in the illustration.*

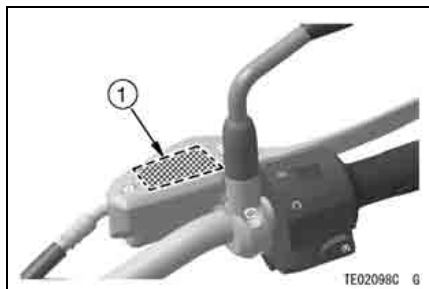

1. Brake Fluid (Front)

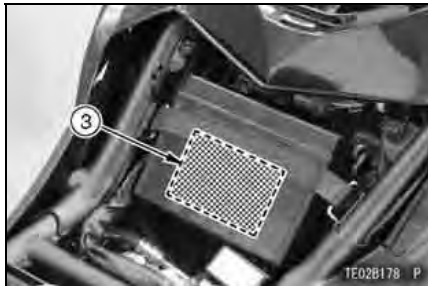
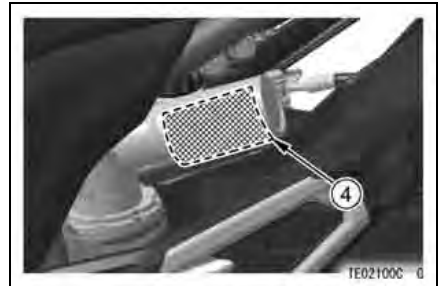
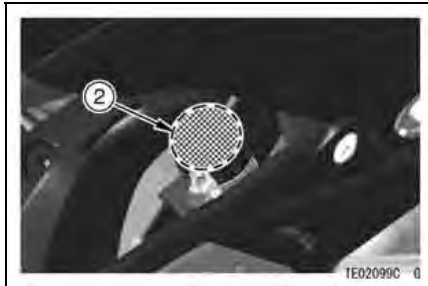

- 2. Brake Fluid (Rear)
- 3. Battery Poison/Danger
- 4. Rear Shock Absorber Warning

28 GENERAL INFORMATION

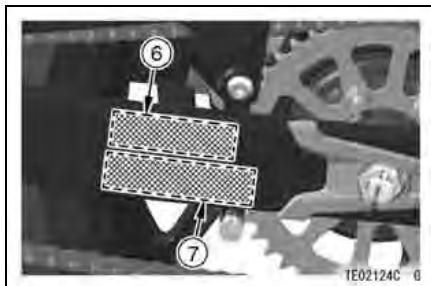
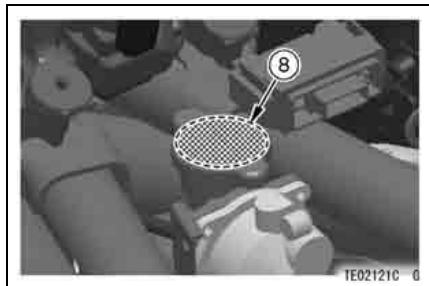

- *5. Unleaded Gasoline
- 6. Tire and Load Data
- 7. Important Drive Chain Information
- 8. Radiator Cap Danger

*: Only on Australian model

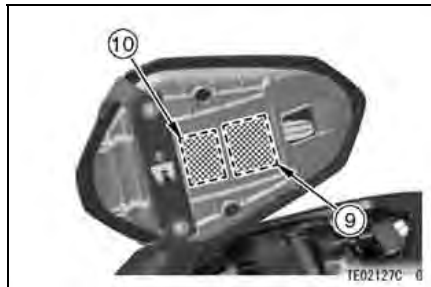

- 9. Daily Safety Checks
- *10. Stationary Noise Test Information

*: Only on Australian model

30 GENERAL INFORMATION

1)

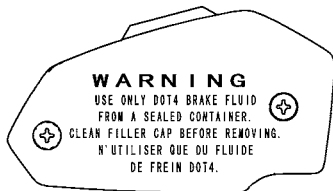

TE03841BN9 C

3)



TE03508D S

2)

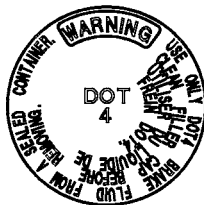

TE03491DN9 C

4)



TE03501D S

32 GENERAL INFORMATION

9)

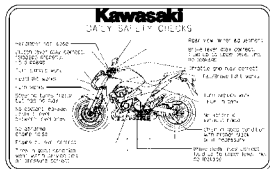

56033-0741

TE03505D S

10) only on Australia model

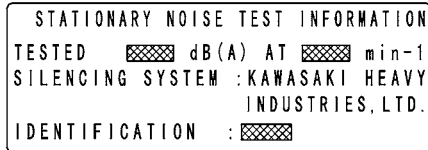

TE03476DN9 C

Location of Parts

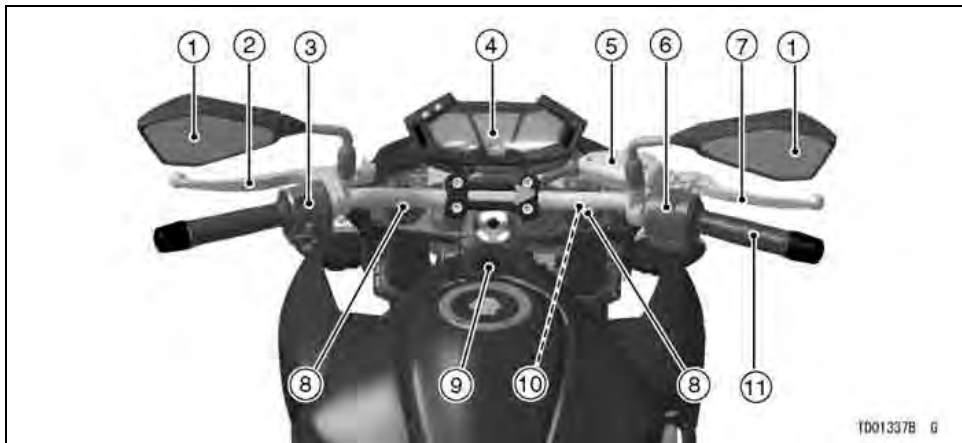

1. Rear View Mirrors
2. Clutch Lever
3. Left Handlebar Switches
4. Meter Instruments
5. Brake Fluid Reservoir (Front)
6. Right Handlebar Switches

7. Front Brake Lever
8. Spring Preload Adjusters
9. Ignition Switch/Steering Lock
10. Rebound Damping Force Adjuster (Front Fork)
11. Throttle Grip

34 GENERAL INFORMATION

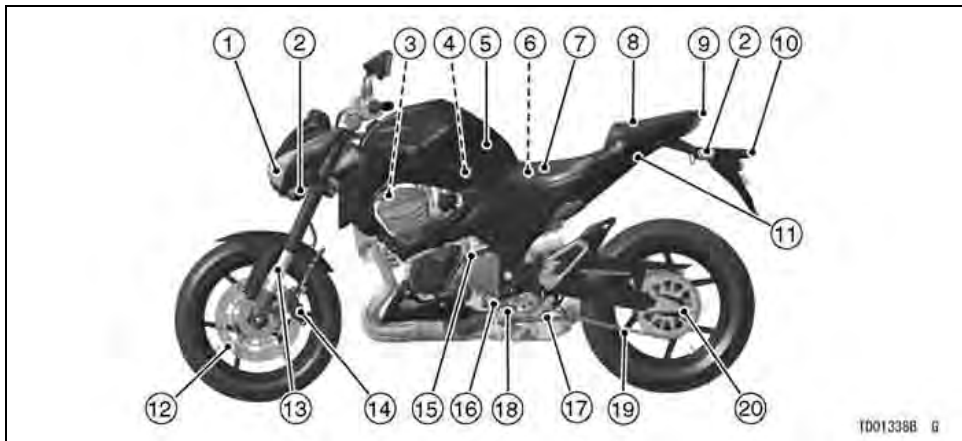

T001338B G

1. Headlight
2. Turn Signal Lights
3. Spark Plugs
4. Air Cleaner
5. Fuel Tank
6. Fuse Box
7. Rider's Seat
8. Passenger's Seat

9. Tail/Brake Light
10. License Plate Light
11. Seat Lock
12. Brake Disc
13. Front Fork
14. Brake Caliper
15. Idle Adjusting Screw
16. Shift Pedal

17. Side Stand
18. Rebound Damping Force Adjuster (Rear Shock Absorber)
19. Drive Chain
20. Chain Adjuster

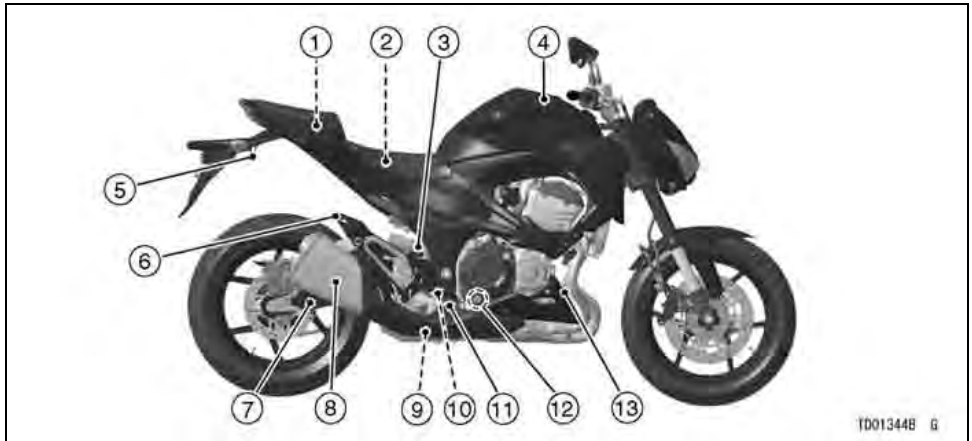

- | | |
|---|---------------------------------|
| 1. Tool Kit | 7. Swingarm |
| 2. Battery | 8. Muffler |
| 3. Brake Fluid Reservoir (Rear) | 9. Rear Shock Absorber |
| 4. Fuel Tank Cap | 10. Rear Brake Light Switch |
| 5. Tying Hooks (Both Sides) (Other than Australian model) | 11. Rear Brake Pedal |
| 6. Tying Hooks (Both Sides) | 12. Oil Level Inspection Window |
| | 13. Oil Filter |

36 GENERAL INFORMATION

Meter Instruments

- A. Left Button
- B. Right Button
- C. Multifunction Meter (Left Side)
- D. Tachometer
- E. Multifunction Meter (Right Side)
- F. Green Left Turn Signal Indicator Light
- G. Yellow Engine Warning Indicator Light
- H. Yellow ABS Indicator Light (only on ABS model)
- I. Red Warning Indicator Light
- J. Green Neutral Indicator Light
- K. Blue High Beam Indicator Light
- L. Green Right Turn Signal Indicator Light



TG02039C 0

NOTE

- For safety, do not operate the instrument buttons while riding the motorcycle.

Tachometer

The tachometer shows the engine speed in revolutions per minute (r/min, rpm). The upper (higher) zone of the tachometer is a portion called the “red zone.” Engine r/min (rpm) in the red zone is above maximum recommended engine speed and is also above the range for good performance.

NOTICE

Engine r/min (rpm) should not be allowed to enter the red zone; operation in the red zone will overstress the engine and may cause serious engine damage.

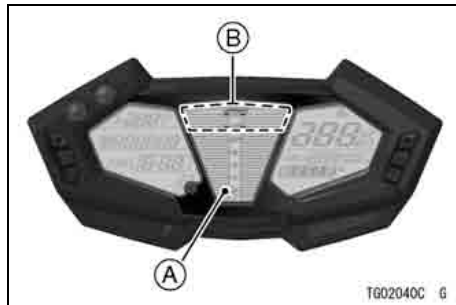

- A. Tachometer
- B. Red Zone

When the ignition switch is turned on, the tachometer bar(s) momentarily go from the minimum to the maximum, then go back from the maximum to the minimum reading to check its operation. If the tachometer does not operate correctly, have it checked by an authorized Kawasaki dealer.

38 GENERAL INFORMATION

Display Pattern Setting

The tachometer display can be changed as follows:

- Push the left and right buttons for more than 2 seconds. The tachometer will sweep in the current display pattern.
- Pushing the left button changes the display pattern as follows.

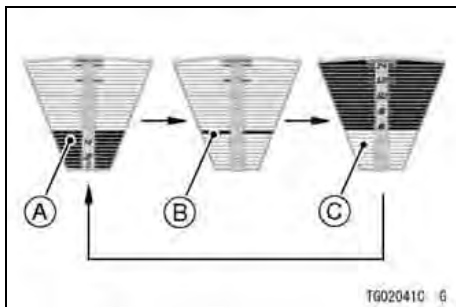

- A. Zone Display - Black
- B. Bar Display
- C. Zone Display - White

- Hold the left and right buttons for more than 2 seconds to set the display.

NOTE

- *The tachometer display pattern cannot be changed while the input value to the speedometer is more than 5 km/h (4 mph).*
- *When the input value to the speedometer becomes more than 5 km/h (4 mph) while changing the tachometer display pattern, the pattern at the time is set and the meter returns to the normal operation.*

Multifunction Meter (Right Side)

- A. Economical Riding Indicator
- B. Speedometer
- C. Multifunction Display
 - Current Mileage
 - Average Mileage
 - Cruising Range
- D. Fuel Gauge/Fuel Warning Symbol

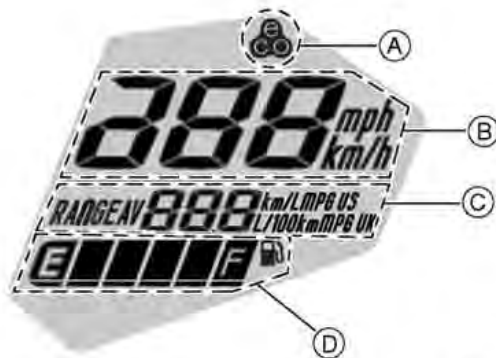

TG02050C ①

40 GENERAL INFORMATION

Speedometer

The speedometer shows the speed of the vehicle in digital values.

NOTE

- *When the input value to the speedometer becomes less than 5 km/h (4 mph), the numerical value shows "0."*

Unit Setting

The unit setting in the multifunction meter can be changed according to local regulations. Make sure the unit setting is correctly displayed before riding.



A. Meter Display Units

NOTE

- *Do not operate the motorcycle with wrong unit (mph or km/h) of the speedometer.*

To change the meter display units in the multifunction meter as follows:

- Display the odometer in the multifunction display.
- Display current mileage or cruising range, and push the left button while

pushing the right button to select the meter display units. The display units can be shifted in the following order.

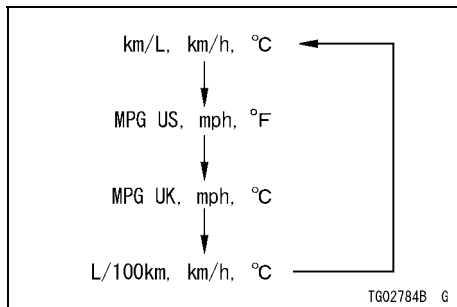

NOTE

- *The meter display units are maintained even if the battery is disconnected.*

Multifunction Display

The multifunction display indicates the following modes.

- Current Mileage
- Average Mileage
- Cruising Range

When the right button is pushed, the display modes can be shifted as follows.

Current mileage → Average mileage
→ Cruising range → Current mileage...

NOTE

- *When the battery is disconnected, the multifunction display indicates the current mileage.*

Current Mileage

This display mode shows the current mileage by numerical value. The current mileage display is renewed every 4 seconds.

42 GENERAL INFORMATION



A. Current Mileage

NOTE

- *The numerical value shows “- -.-” until 4 seconds have passed and the speedometer rises to above 0 km/h (0 mph).*
- *When the ignition switch is turned off, the current mileage resets to “0.0”.*

Average Mileage

This display mode shows the average mileage by numerical value counted from the start of measuring to present time. The average mileage display is renewed every 5 seconds.



A. Average Mileage

B. “AV”

- While the average mileage is displayed, push the right button for more than 2 seconds. The average mileage values resets to “- -.-”.

NOTE

- *The data is maintained by backup power if the ignition switch is turned off.*
- *When the battery is disconnected, the average mileage resets to “- -.-”.*
- *After resetting the average mileage, the numerical value is not displayed until 5 mL (0.2 US oz.) of fuel has*

been used and 100 m (328 ft) has been traveled.

Cruising Range

This display mode shows the cruising range by numerical value and indicates the cruising range from the remaining fuel in the fuel tank. This cruising range display is renewed every 20 seconds.

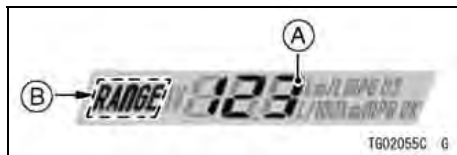

- A. Cruising Range
- B. "RANGE"

The cruising range value displays "—" when the fuel warning symbol (🛢️) blinks in the multifunction meter.

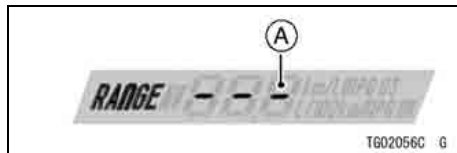

- A. "—" display

NOTE

- The display range for cruising range is 0 ~ 999.
- The cruising range value may not indicate the actual value. Use this value for your reference only.

Economical Riding Indicator

When the operator is driving the motorcycle for optimum fuel-efficiency, the economical riding indicator appears on the multifunction meter to indicate favorable fuel consumption. Monitoring the economical riding indicator can help the rider maximize fuel efficiency.

44 GENERAL INFORMATION



A. Economical Riding Indicator

⚠ WARNING

Failing to properly observe the road ahead increases the chance of an accident resulting in severe injury or death. Do not concentrate on the economical riding indicator by taking your eyes off the road; observe using peripheral vision.

Fuel Gauge

The fuel in the fuel tank is shown by the number of segments displayed.

When the fuel tank is full, all the segments are displayed. As the fuel level in the tank goes down, the segments disappear one by one from F (full) to E (empty). The lowest segment and fuel level warning symbol blink in the multi-function meter when approximately 4.0 L (1.1 US gal) of usable fuel remains.

Refuel at the earliest opportunity if the most bottom segment of the fuel gauge blinks. When vehicle stands with side stand, fuel gauge cannot show the amount of fuel in the fuel tank exactly. Stand upright the vehicle to check the fuel level.

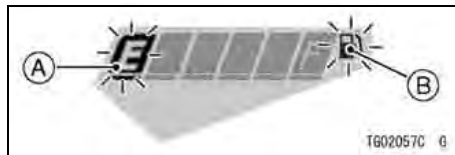

A. Segment (E)

B. Fuel Warning Symbol (🔥)

All of the segments and fuel warning symbol will blink in case of the open or short of the wiring. Have the wiring

inspected by an authorized Kawasaki dealer immediately.

Multifunction Meter (Left Side)

- A. Coolant Temperature Meter
- B. Multifunction Display
 - Odometer
 - Trip Meter A
 - Trip Meter B
- C. Clock
- D. Warning Symbols

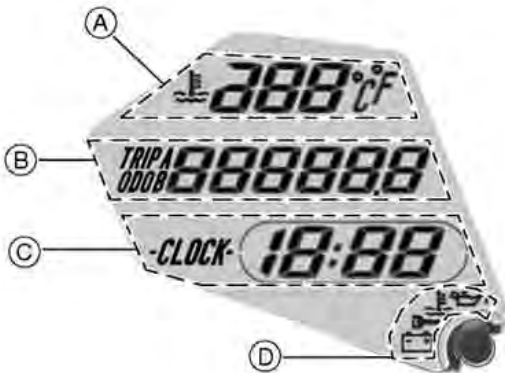

TG02042C-0

Coolant Temperature Meter

The coolant temperature meter indicates temperature of the engine coolant.



A. Coolant Temperature Meter

- If the coolant temperature is below 40°C (104°F), "--" is displayed.



When the coolant temperature rises to above 40°C (104°F), the numerical value of the coolant temperature at the present state is displayed.



- If the coolant temperature rises to above 115°C (239°F) and below 120°C (248°F), the numerical value of the current coolant temperature starts blinking, the red warning indicator light and coolant temperature warning symbol also go on. This warns the operator that the coolant temperature is high.

48 GENERAL INFORMATION



- A. Coolant Temperature Warning Symbol**
B. Red Warning Indicator Light

If the coolant temperature rises to above 120°C (248°F), "HI" is displayed and starts blinking, the red warning indicator light and coolant temperature warning symbol also go on. This warns the operator that the coolant temperature is too high. Stop the engine and

check the coolant level in the reserve tank after the engine cools down. Have the cooling system checked by an authorized Kawasaki dealer.



- A. Coolant Temperature Warning Symbol**
B. Red Warning Indicator Light

NOTICE

Do not let the engine continue running when the coolant temperature shows “HI”. Prolonged engine operation will result in severe engine damage from overheating.

Multifunction Display

The multifunction display indicates the following modes.

- Odometer
- Trip Meter A
- Trip Meter B

When the left button is pushed, the display modes can be shifted as follows.

Odometer → Trip meter A → Trip meter B → Odometer...

NOTE

- When the battery is disconnected, the multifunction display indicates the odometer.

Odometer

The odometer shows the total distance in kilometers or miles that the vehicle has run. If the odometer is displayed, the “ODO” is displayed on the multifunction display. This meter cannot be reset.



- A. Odometer
- B. “ODO”

50 GENERAL INFORMATION

NOTE

- *The data are maintained even if the battery is disconnected.*
- *When the figures come to 999999, the display is stopped and locked.*

Trip Meter A/B

The trip meter has two meters which distinguished between the “TRIP A” and “TRIP B”. The trip meter shows the distance in kilometers or miles traveled since it was last reset to zero.

TRIP A: 0.0 ~ 9999.9

TRIP B: 0.0 ~ 9999.9



A. Trip Meter

B. “TRIP A”

To reset the trip meter:

- Push the left button to select the trip meter A or B.
- Push the left button for more than 2 seconds. The figure display turns to 0.0, and then starts counting when the vehicle is operated. The meter counts until it is next reset.

NOTE

- *The data is maintained even if the battery is disconnected.*
- *When the trip meter reaches 9999.9 while riding, the meter resets to 0.0 and continues counting.*

Clock

To adjust hours and minutes, do the followings while the motorcycle is at a stop.

- Display the odometer in the multi-function display.

- Push the left button for more than 2 seconds. Both the hour and minute displays start blinking.

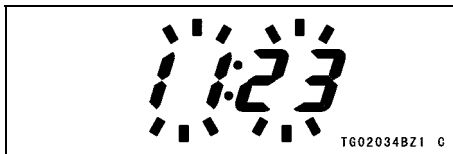

- Push the right button. The hour display only blinks. Push the left button to advance the hours.

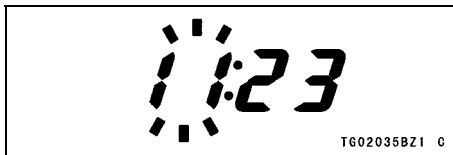

- Push the right button. The hour display stops blinking and the minute display starts blinking. Push the left button to advance the minutes.

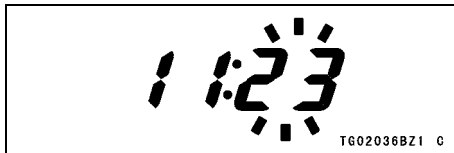

- Push the right button. Both the hour and minute displays start blinking again.
- Push the left button. The displays stop blinking and the clock starts working.

NOTE

- *Pushing the left button momentarily advances the hour or minute step by step. Pushing and holding the button advances the hour or minute continuously.*
- *The clock works normally by the backup power while the ignition switch is turned off.*

52 GENERAL INFORMATION

- *When the battery is disconnected, the clock is reset to 1:00 and starts working again when the battery is connected.*

Indicator Lights

Green Neutral Indicator Light

N : When the transmission is in neutral, the neutral indicator light goes on.

Blue High Beam Indicator Light

 : When the headlight is on high beam, the high beam indicator light goes on.

Green Turn Signal Indicator Light

 : When the turn signal switch is pushed to the left or right, the turn signal indicator light blinks.

Yellow ABS Indicator Light (For models equipped with ABS)

 : The ABS (Anti-lock Brake System) indicator light comes on when the ignition switch is turned on and goes off shortly after the motorcycle starts moving. If the ABS is normal, it stays off. If something is wrong with the ABS, the indicator comes on and remains lit. When the indicator light is on, the ABS does not function but if the ABS fails, the conventional brake system will still work normally.

For more detailed information about ABS, see the Anti-lock Brake System (ABS) section in the HOW TO RIDE THE MOTORCYCLE chapter.

Warning Indicator Lights

Yellow Engine Warning Indicator Light

 : The engine warning indicator light goes on when the ignition key is turned on and goes off soon after ensuring that its circuit functions properly. The warning indicator light also goes on or blinking whenever the troubles occur in digital fuel injection system (DFI).

The blinking of this warning indicator light indicates the condition that the engine cannot be started.

See the Stopping the Engine section in the HOW TO RIDE THE MOTORCYCLE chapter for more information. If the warning indicator light goes on, have the DFI system checked by an authorized Kawasaki dealer.

Red Warning Indicator Light

This warning indicator light has the four warning functions: coolant temperature warning, oil pressure warning, immobilizer warning and battery charging system warning. For more detailed information, see appropriate sections in this chapter.

Coolant Temperature Warning Symbol



 : The red warning indicator light and the coolant temperature warning symbol go on whenever the coolant temperature rises to about 115°C (239°F) when the motorcycle is in operation. If they go on, stop the engine and check the coolant level in the reserve tank after the engine cools down. Have the cooling system checked by an authorized Kawasaki dealer.

54 GENERAL INFORMATION



NOTICE

Do not let the engine continue running when the coolant temperature warning symbol goes on. Prolonged engine operation will result in severe damage from overheating.

Oil Pressure Warning Symbol

 : The red warning indicator light and the oil pressure warning symbol () goes on whenever the oil pressure is dangerously low or the ignition switch is in the "ON" position with the engine not running, and go off when the engine oil pressure is high enough. Refer to the MAINTENANCE AND ADJUSTMENT chapter for more detailed engine oil information.

Immobilizer Warning Symbol

 : The red warning indicator light and the immobilizer warning symbol () blinks whenever the ignition switch is turned on or trouble occurs in the immobilizer system. After turning the ignition switch on, the immobilizer warning symbol () goes off soon after it is ensured that its circuit is functioning properly.

If the red warning indicator light and warning symbol blinks, have the immobilizer system checked by an authorized Kawasaki dealer.

When the ignition switch is turned off, the red warning indicator light will start blinking, which indicates that the immobilizer system is functioning. After 24 hours have passed, the red warning indicator light will stop blinking, however, the immobilizer system is still functioning. Red warning indicator light blinks



if the improperly coded key is used, or any incorrect communication between antenna and key is occurred. However, when the properly coded key can be used, or the communication is clear, the red warning indicator light does not blink.

NOTE

- *The red warning indicator light blinking mode can be set to either on or off. Push and hold the left and right meter buttons simultaneously for more than 2 seconds, within twenty seconds after turning the ignition switch to the "OFF" position, then the red warning indicator light will not blink.*
- *When the battery is connected, red warning indicator light defaults to blinking mode.*
- *When the battery voltage is low (below 12 V), red warning indicator light*

blinking automatically stop blinking to prevent excessive battery discharge.

Battery Warning Symbol

 : The red warning indicator light and the battery warning symbol () go on whenever the battery voltage is less than 11.0 V or more than 16.0 V. If they go on, have the battery voltage checked by an authorized Kawasaki dealer.

NOTE

- *When the all indicator lights and display of the meter go off, the battery voltage is insufficient. Have the machine checked by an authorized Kawasaki dealer promptly because the engine might stop suddenly when keeping running in that condition.*

56 GENERAL INFORMATION

Keys

This motorcycle has a combination key, which is used for the ignition switch/steering lock, seat lock, and fuel tank cap.

Immobilizer System

This motorcycle is equipped with an immobilizer system to protect your motorcycle from theft. This motorcycle has two ignition keys. Store the one ignition key and the key tag in a safe place. If all ignition keys are lost, registering new codes for replacement ignition keys into the electronic control unit

is impossible. Registering additional ignition key should be done by an authorized Kawasaki dealer. Blank keys are available at your Kawasaki dealers. Ask your dealer to make any additional spare keys you may need, using your original key as a master. To make additional ignition keys, take the vehicle along with all ignition keys to an authorized Kawasaki dealer to have them re-registered. Up to five ignition keys can be registered with the immobilizer system at one time.

NOTICE

Do not put two keys of any immobilizer system on the same key ring.

Do not submerge any key in water.

Do not expose any key to excessively high temperature.

Do not place any key close to magnets.

Do not place heavy item on any key.

Do not grind any key or alter its shape.

Do not disassemble the plastic part of any key.

Do not drop any key and/or apply shocks to it.

If a ignition key is lost, re-registry at dealer is securely required to prevent the possibility of theft.

NOTICE

If all ignition keys are lost, an authorized Kawasaki dealer will have to replace the ECU and order new ignition keys.

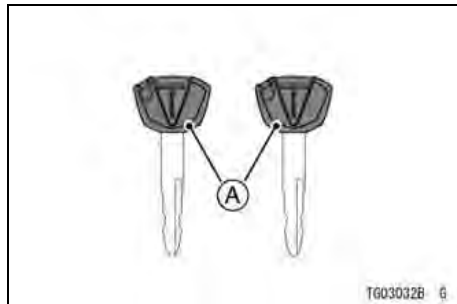
**A. Ignition keys**

- Ignition keys: You can register maximum 5 ignition keys at one time.

If an improperly coded key is used or any incorrect communication between

58 GENERAL INFORMATION

ECU and key is occurred, the engine does not start with the immobilizer warning symbol () and warning indicator light blinks.

A properly coded key must be used and the communication should be clear for the engine to start.

When the key is turned to “OFF”, the warning indicator light will start blinking, which indicates that the immobilizer system is functioning. After 24 hours have passed, the warning indicator light will stop blinking, however, the immobilizer system is still functioning.

If all ignition keys are lost, registering new ignition key codes is impossible and the ECU must be replaced.

NOTE

- *Warning indicator light blinking mode can be set to either on or off. Push*

and hold the left and right buttons simultaneously for more than two seconds, within twenty seconds after turning the ignition key to the “OFF” position, then the warning indicator light will not blink.

- *When the battery is connected, warning indicator light is set to blinking mode by default.*
- *When the battery voltage is low (below 12 V), warning indicator light automatically stops blinking to prevent excessive battery discharge.*

EC Directive Compliance

This immobilizer system complies with the R & TTE (Radio equipment and telecommunications terminal equipment and the mutual recognition of their conformity) Directive.

Ignition Switch/Steering Lock

This is a four-position, key-operated switch. The key can be removed from the switch when it is in the OFF, LOCK or  position.

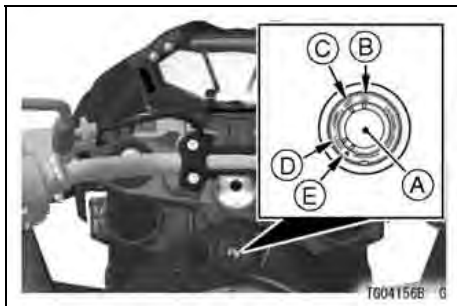

- A. Ignition Switch/Steering Lock
- B. ON position
- C. OFF position
- D. LOCK position
- E.  position

OFF	Engine off. Electrical circuits off.
ON	Engine on. All electrical equipment can be used.
LOCK	Steering locked. Engine off. Electrical circuits off.
	Steering locked. Engine off. Turn signals can be used. Other electrical circuits off.

NOTE

- *The tail and license plate lights are on whenever the ignition key is in the "ON" position. Headlights go on when the starter button is released after starting the engine. To avoid battery discharge, always start the engine immediately after turning the ignition key to "ON."*
- *If you leave the "ON" position on for a long time, the battery may become totally discharged.*

60 GENERAL INFORMATION

Right Handlebar Switches

To operate the ignition Switch:

LOCK ← OFF ↔ ON



1. Turn the handlebar fully to the left.

2. For locking push down the key in the OFF position and turn it to LOCK.



TG04142BZ2 C

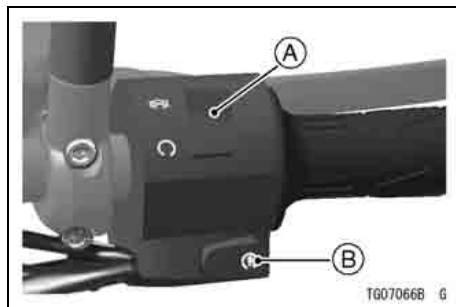

A. Engine Stop Switch

B. Starter Button

Engine Stop Switch

In addition to the ignition switch, the engine stop switch must be in the  position for the motorcycle to operate.

The engine stop switch is for emergency use. If required, move the switch to the  position.

NOTE

- Although the engine stop switch stops the engine, it does not turn off all the electrical circuits. Ordinarily, the ignition switch should be used to stop the engine.

Starter Button

The starter button operates the electric starter when the transmission is in neutral.

Refer to the Starting the Engine section in the HOW TO RIDE THE MOTORCYCLE chapter for starting instructions.

Left Handlebar Switches

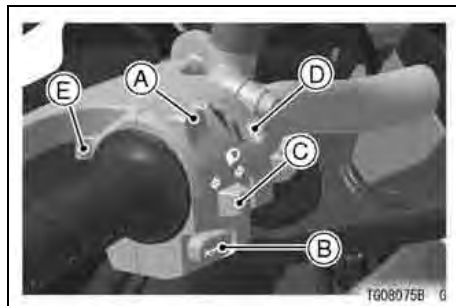

- A. Dimmer Switch
- B. Horn Button
- C. Turn Signal Switch
- D. Hazard Switch
- E. Passing Button



Dimmer Switch

High or low beam can be selected with the dimmer switch. When the headlight is on high beam (), the high beam indicator light goes on.

High beam.....()

Low beam.....()

Turn Signal Switch

When the turn signal switch is turned to the left () or right (), the corresponding turn signals blink on and off.

To stop blinking, push the switch in.

Horn Button

When the horn button is pushed, the horn sounds.

Hazard Switch

If an emergency requires you to park on the highway shoulder, turn on the hazard lights to warn other drivers of your location.

Push in the hazard switch with the ignition switch in the "ON" or "  " position. All the turn signals and turn signal indicator lights will blink on and off.

NOTICE

If you leave the switch on for a long time, the battery may become totally discharged. So be careful not to use the hazard lights for more than 30 minutes.

Passing Button

When the passing button is pushed, the headlight high beam (passing beam) goes on to signal the driver of the vehicle ahead that you are about to pass. The passing light is shut off as soon as the button is released.

Brake Lever Adjuster

There is an adjuster on the brake lever. The adjuster has 5 positions so that the released lever position can be adjusted to suit the operator's hands.

Push the lever forward and turn the adjuster to align the number with the mark on the lever holder. The distance from the grip to the released lever is minimum at Number 5 and maximum at Number 1.

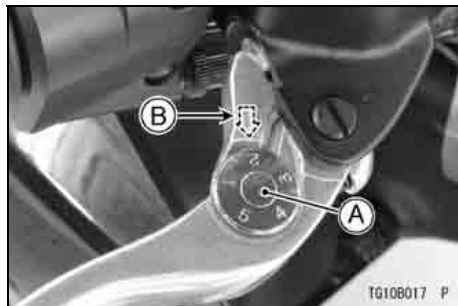

A. Adjuster
B. Mark

Fuel Tank Cap

To open the fuel tank cap, pull up the key hole cover. Insert the ignition key into the fuel tank cap and turn the key clockwise.

To close the cap, push it down into place with the key inserted. The key can be removed by turning counterclockwise to the original position. Close the key hole cover.

NOTE

- *The fuel tank cap cannot be closed without the key inserted, and the key cannot be removed unless the cap is locked properly.*
- *Do not push on the key to close the cap, or the cap cannot be locked.*

64 GENERAL INFORMATION

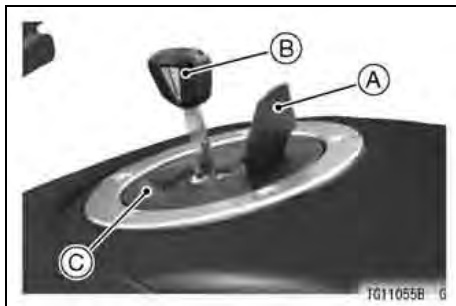

- A. Key Hole Cover
- B. Ignition Key
- C. Fuel Tank Cap

Fuel

Fuel Requirements

Your Kawasaki engine is designed to use only unleaded gasoline with a

minimum octane rating shown below. Never use gasoline with an octane rating lower than the minimum specified by Kawasaki to prevent severe engine damage.

The octane rating of a gasoline is a measure of its resistance to detonation or “knocking.” The term commonly used to describe a gasoline’s octane rating is the Research Octane Number (RON).

NOTICE

Do not use leaded gasoline, as this will destroy the catalytic converter.

NOTICE

If engine “knocking” or “pinging” occurs, use a different brand of gasoline of a higher octane rating. If this condition is allowed to continue, it can lead to severe engine damage. Gasoline quality is important. Fuels of low quality or not meeting standard industry specifications may result in unsatisfactory performance. Operating problems that result from the use of poor quality or no recommended fuel may not be covered under your warranty.

Fuel Type and Octane Rating**(Except for Brazil Specification)**

Use clean, fresh unleaded gasoline with an octane rating equal to or higher than that shown in the table.

Fuel Type	Unleaded Gasoline
Minimum Octane Rating	Research Octane Number (RON) 95

NOTICE

Do not use any fuel with an ethanol in this vehicle. It has not been tested and certified for use with such fuels. Damage to the engine and fuel system, or engine starting and/or performance problems may result from the use of improper fuel.

(For Brazil Specification)

Use clean, fresh unleaded gasoline with an Antiknock Index equal to or higher than that shown in the table.

The Antiknock Index is posted on service station pumps. The Antiknock Index is an average of the Research Octane Number (RON) and the Motor Octane Number (MON) as shown in the table.

Fuel Type	Unleaded Gasoline
Ethanol Content	E25
Minimum Octane Rating	Antiknock Index $\frac{\text{RON} + \text{MON}}{2}$ 90

NOTICE

Do not use any fuel that contains more ethanol or other oxygenates than specified for E25 fuel* in this vehicle. Damage to the engine and fuel system, or engine starting and/or performance problems may result from the use of improper fuel.

*E25 means fuel containing up to 25% ethanol.

Filling the Tank

Avoid filling the tank in the rain or where heavy dust is blowing so that the fuel does not get contaminated.

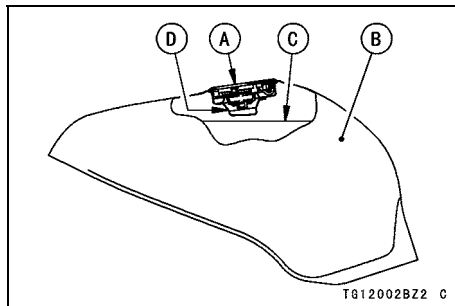

- A. Tank Cap
- B. Fuel Tank
- C. Top Level
- D. Filler Neck

⚠ WARNING

Gasoline is extremely flammable and can be explosive under certain conditions, creating the potential for serious burns. Turn the ignition switch off. Do not smoke. Make sure the area is well ventilated and free from any source of flame or sparks; this includes any appliance with a pilot light. Never fill the tank completely to the top. If the tank is filled completely to the top, heat may cause the fuel to expand and overflow through the vents in the tank cap. After refueling, make sure the tank cap is closed securely. If gasoline is spilled on the fuel tank, wipe it off immediately.

68 GENERAL INFORMATION

NOTICE

Certain ingredients of gasoline may cause paint fading or damage. Be extra careful not to spill gasoline or gasoline oxygenates blends during refueling.

Side Stand

The motorcycle is equipped with the side stand.



A. Side Stand

NOTE

○ *When using the side stand, turn the handlebar to the left.*

Do not sit on the motorcycle while it is on its side stand. Always kick the stand fully up before sitting on the motorcycle.

NOTE

- *The motorcycle is equipped with a side stand switch. This switch is designed so that the engine does not start if the transmission is in gear and the side stand is down.*

Seats

Passenger's Seat Removal

- Insert the ignition key into the seat lock.
- Pull up the front of passenger's seat while turning the key clockwise.
- Remove the passenger's seat forward.

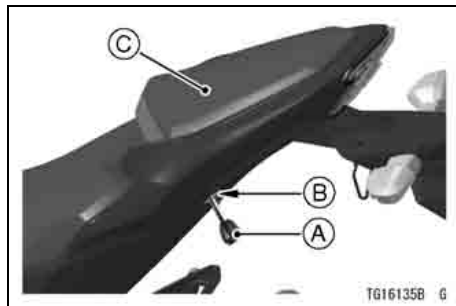

- A. Ignition Key
- B. Seat Lock
- C. Passenger's Seat

Rider's Seat Removal

- Remove the passenger's seat, see the Passenger's Seat Removal in this section.
- Remove the bolt and bracket.

70 GENERAL INFORMATION

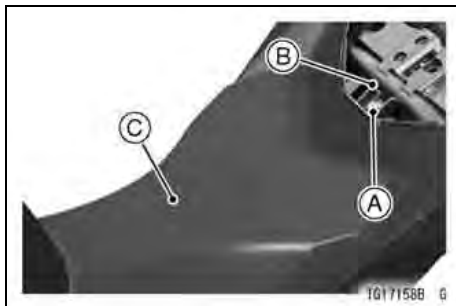

- A. Bolt
- B. Bracket
- C. Rider's Seat

- Pull the rider's seat backward to clear the tabs.
- Remove the rider's seat.

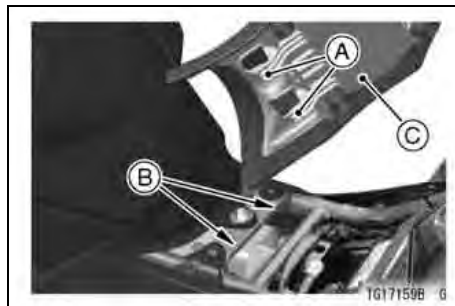

- A. Tabs
- B. Slots
- C. Rider's Seat

Rider's Seat Installation

- Insert the tabs at the front of the rider's seat into the slots on the frame.
- Be sure that the hooks fit into the holes of the rider's seat.

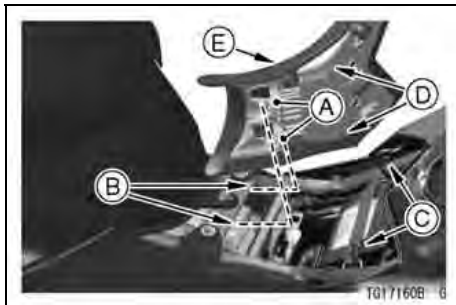

- A. Tabs
- B. Slots
- C. Hooks
- D. Holes
- E. Rider's Seat

- Insert the bracket into the hole at the rear of rider's seat while pushing down the rear part of the rider's seat.
- Tighten the bolt while pushing forward the rear part of the rider's seat.

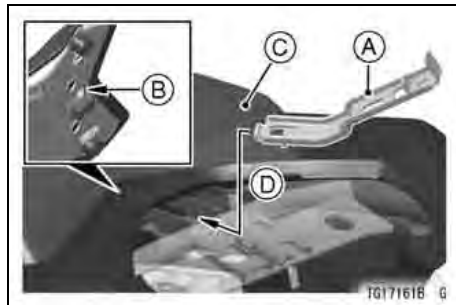

- A. Bracket
- B. Hole
- C. Rider's Seat
- D. To Forward

Passenger's Seat Installation

- Insert the tab at the rear of the passenger's seat into the slot on the frame.
- Insert the hook at the front of the passenger's seat into the hole on the frame.

72 GENERAL INFORMATION

- Push down the front part of the passenger's seat until the lock clicks.

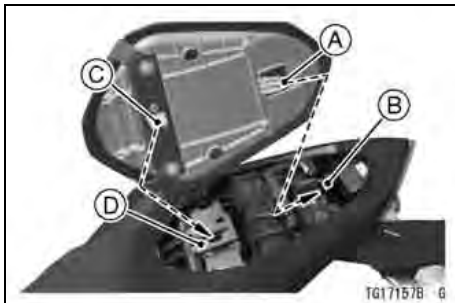

- A. Tab
- B. Slot
- C. Hook
- D. Hole

- Pull up the front and rear ends of the passenger's seat to make sure they are securely locked.

Tying Hooks

When tying up light loads to the seat, use the tying hooks located in rear of the rear footpegs, below the passenger's seat.

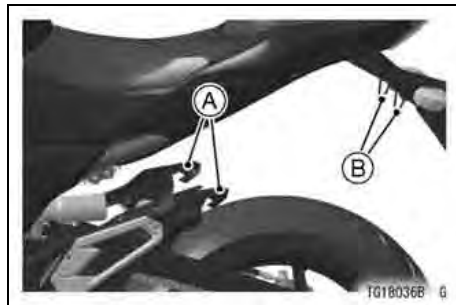

- A. Tying Hooks
- B. Tying Hooks (Other than Australian model)

Tool Kit

The tool kit is located under the passenger's seat.

The kit contains tools that can be helpful in making roadside repairs, adjustments, and some maintenance procedures explained in this manual. Keep the tool kit in the original place.



A. Tool Kit

Rear View Mirror

Rear View Mirror Adjustment

- Adjust the rear view mirror by slightly moving only the mirror portion of the assembly.
- If the rear visibility can not be assured by moving the mirror, loosen the upper hexagonal area and turn the stay by hand.

NOTE

- *The upper hexagonal area (locknut) has left hand threads.*

74 GENERAL INFORMATION

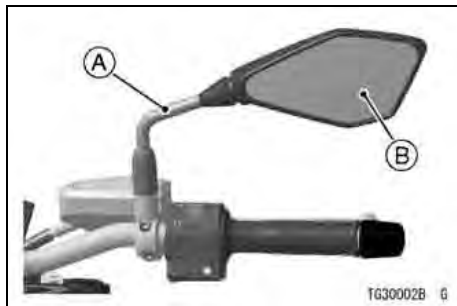

- A. Stay
- B. Rear View Mirror

Tightening Torque

Lower Hexagonal Area:

30 N·m (3.1 kgf·m, 22 ft·lb)

Upper Hexagonal Area:

18 N·m (1.8 kgf·m, 13 ft·lb)

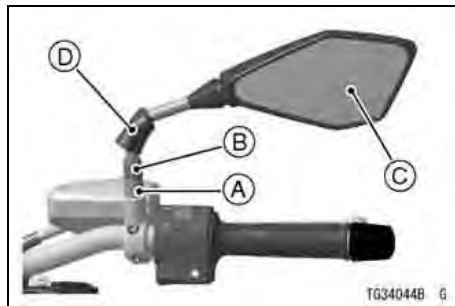

- A. Lower Hexagonal Area for Tightening
- B. Upper Hexagonal Area
- C. Rear View Mirror
- D. Rubber Boots

NOTE

- *If a torque wrench is not available, this item should be serviced by a Kawasaki dealer.*

Event Data Recorder

This vehicle is equipped at the factory with an event data recorder (EDR). The main purpose of this device is to record data that assists with understanding of how a vehicle's systems performed during a short period of time. Among other things, this data can help provide a better understanding of the circumstances in which crashes occur. This device does not collect or store personal data or information (e.g. name, gender, age). The EDR in this vehicle is designed to record such data as: vehicle speed, engine crankshaft rotational speed, throttle opening.

To read the data recorded by the EDR, special equipment is required, and access to the vehicle or EDR is necessary. In addition to Kawasaki, other parties, such as law enforcement that have special equipment, can read the information if they have access to the EDR. Kawasaki does not access the EDR information without obtaining consent, unless pursuant to court order or where required by law enforcement, other government authorities, or other third parties acting with lawful authority. Other parties may seek to access the recorded data independently of Kawasaki.

HOW TO RIDE THE MOTORCYCLE

Break-In

The first 1 600 km (1 000 mi) that the motorcycle is ridden is designated as the break-in period. If the motorcycle is not used carefully during this period, you may very well end up with a “broken down” instead of a “broken in” motorcycle after a few thousand kilometers.

The following rules should be observed during the break-in period.

- The table shows maximum recommended engine speed during the break-in period.

Distance traveled	Maximum engine speed
0 ~ 800 km (0 ~ 500 mi)	4 000 r/min (rpm)
800 ~ 1 600 km (500 ~ 1 000 mi)	6 000 r/min (rpm)

NOTE

- *When operating on public roadways, keep maximum speed under traffic law limits.*
- Do not start moving or race the engine immediately after starting it, even if the engine is already warm. Run the engine for two or three minutes at idle speed to give the oil a chance to work up into all the engine parts.

- Do not race the engine while the transmission is in neutral.

⚠ WARNING

New tires are slippery and may cause loss of control and injury. A break-in period of 160 km (100 miles) is necessary to establish normal tire traction. During break-in, avoid sudden and maximum braking and acceleration, and hard cornering.

In addition to the above, at 1 000 km (600 mi) it is extremely important that the owner has the initial maintenance service performed by an authorized Kawasaki dealer.

Starting the Engine

- Check that the engine stop switch is in the  position.

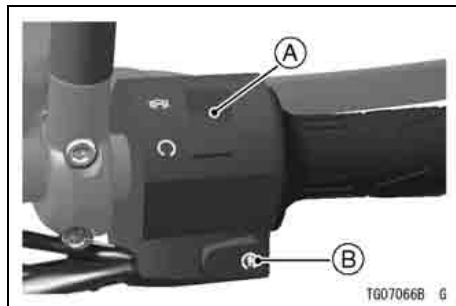

- A. Engine Stop Switch**
- B. Starter Button**

- Turn the ignition key to “ON” position.
- Make sure the transmission is in neutral.

78 HOW TO RIDE THE MOTORCYCLE

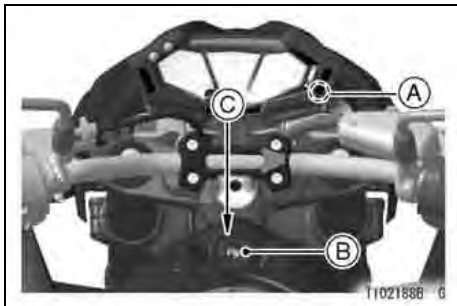

- A. Green Neutral Indicator Light
- B. Ignition Switch
- C. ON position

NOTE

- *The motorcycle is equipped with a vehicle-down sensor which causes the engine to stop automatically if the motorcycle falls down. The engine warning indicator light () blinks when the starter button is pressed if the engine cannot be started. After*

righting the motorcycle, first turn the ignition key to “OFF” and then back to “ON” before starting the engine.

- Without holding the throttle grip, push the starter button to start the engine.

NOTICE

Do not operate the starter continuously for more than 5 seconds, or the starter will overheat and the battery power will drop temporarily. Wait 15 seconds between each operation of the starter to let it cool and the battery power recover.

NOTE

- *The motorcycle is equipped with a starter lockout switch. This switch is designed so that the engine does not start if the transmission is in gear and*

the side stand is down. However, the engine can be started if the clutch lever is pulled and the side stand is fully up.

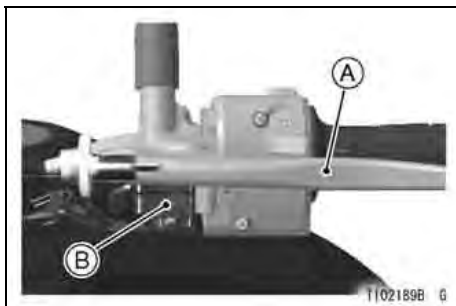

- A. Clutch Lever
- B. Starter Lockout Switch

NOTICE

Do not let the engine idle longer than five minutes, or engine overheating and damage may occur.

Jump Starting

If your motorcycle battery is “run down”, it should be removed and charged. If this is not practical, a 12 volt booster battery and jumper cables may be used to start the engine.

⚠ DANGER

Battery acid generates hydrogen gas which is flammable and explosive under certain conditions. It is present within a battery at all times, even in a discharged condition. Keep all flames and sparks (cigarettes) away from the battery. Wear eye protection when working with a battery. In the event of battery acid contact with skin, eyes, or clothing, wash the affected areas immediately with water for at least five minutes. Seek medical attention.

Connecting Jumper Cables

- Make sure the ignition switch is turned off.

- Remove the rider's seat, see Rider's Seat Removal in the GENERAL INFORMATION chapter.
- Slide the red cap from the positive (+) terminal, see Battery Removal in the MAINTENANCE AND ADJUSTMENT chapter.
- Connect a jumper cable from the positive (+) terminal of the booster battery to the positive (+) terminal of the motorcycle battery.

NOTICE

Be careful not to contact the jumper cable slip on the positive battery terminal to the frame, or it will cause a short circuit.

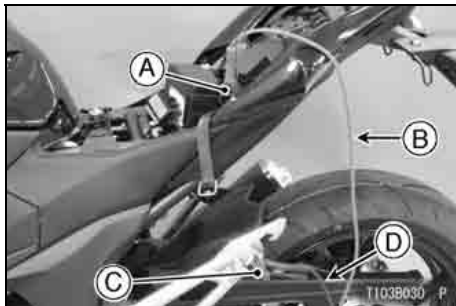

- A. Motorcycle Battery Positive (+) Terminal
- B. From Booster Battery Positive (+) Terminal
- C. Footpeg
- D. From Booster Battery Negative (-) Terminal

- Connect another jumper cable from the negative (-) terminal of the booster battery to your motorcycle footpeg or other unpainted metal surface. Do not use the negative (-) terminal of the battery.

⚠ DANGER

Batteries contain sulfuric acid that can cause burns and produce hydrogen gas which is highly explosive. Do not make this last connection at the fuel system or battery. Take care not to touch the positive and negative cables together, and do not lean over the battery when making this last connection. Do not connect to a frozen battery. It could explode. Do not reverse polarity by connecting positive (+) to negative (-), or a battery explosion and serious damage to the electrical system may occur.

- Follow the standard engine starting procedure.

82 HOW TO RIDE THE MOTORCYCLE

NOTICE

Do not operate the starter continuously for more than 5 seconds or the starter will overheat and the battery power will drop temporarily. Wait 15 seconds between each operation of the starter to let it cool and the battery power recover.

- After the engine has started, disconnect the jumper cables. Disconnect the negative (-) cable from the motorcycle first.
- Reinstall the removed parts.

Moving Off

- Check that the side stand is up.
- Pull in the clutch lever.

- Shift into 1st gear.
- Open the throttle a little, and start to let out the clutch lever very slowly.
- As the clutch starts to engage, open the throttle a little more, giving the engine just enough fuel to keep it from stalling.

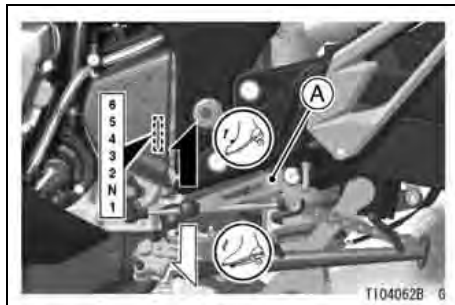
**A. Shift Pedal**

NOTE

- *The motorcycle is equipped with a side stand switch. This switch is designed so that the engine does not start if the transmission is in gear and the side stand is down.*

Shifting Gears

- Close the throttle while pulling in the clutch lever.
- Shift into the next higher or lower gear.
- Open the throttle part way, while releasing the clutch lever.

WARNING

Downshifting to a lower gear at high speed causes engine rpm to increase excessively, potentially damaging the engine and it may also cause the rear wheel to skid and cause an accident. Downshifting should be done below 5 000 rpm for each gear.

NOTE

- *The transmission is equipped with a positive neutral finder. When the motorcycle is standing still, the transmission cannot be shifted past neutral from 1st gear. To use the positive neutral finder, shift down to 1st gear, then lift up on the shift pedal while standing still. The transmission will shift only into neutral.*

84 HOW TO RIDE THE MOTORCYCLE

Braking

- Close the throttle completely, leaving the clutch engaged (except when shifting gears) so that the engine will help slow down the motorcycle.
- Shift down one gear at a time so that you are in 1st gear when you come to a complete stop.
- When stopping, always apply both brakes at the same time. Normally the front brake should be applied a little more than the rear. Shift down or fully disengage the clutch as necessary to keep the engine from stalling.
- Never lock the brakes, or it will cause the tires to skid. When turning a corner, it is better not to brake at all. Reduce your speed before you get into the corner.
- For emergency braking, disregard downshifting, and concentrate on

applying the brakes as hard as possible without skidding.

- Even in motorcycles equipped with ABS, braking during cornering may cause wheel slip. When turning a corner, it is better to limit braking to the light application of both brakes or not to brake at all. Reduce your speed before you get into the corner.

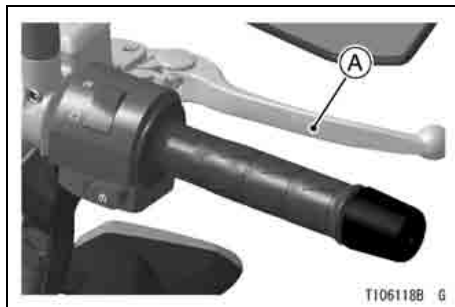

A. Front Brake Lever

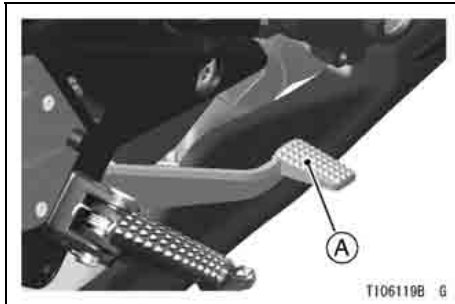

A. Rear Brake Pedal

Anti-lock Brake System (ABS)

(Only on ABS model)

ABS is designed to help prevent the wheels from locking up when the brakes are applied hard while running straight. The ABS automatically regulates brake force. Intermittently gaining gripping force and braking force helps

prevent wheel lock-up and allows stable steering control while stopping.

Brake control function is identical to that of a conventional motorcycle. The brake lever is used for the front brake and the brake pedal for the rear brake.

Although the ABS provides stability while stopping by preventing wheel lock-up, remember the following characteristics:

- To apply the brake effectively, use the front brake lever and rear brake pedal simultaneously in the same manner as conventional motorcycle brake system.
- ABS cannot compensate for adverse road conditions, misjudgment or improper application of brakes. You must take the same care as with motorcycles not equipped with ABS.
- ABS is not designed to shorten the braking distance. On loose, uneven or downhill surfaces, the stopping

86 HOW TO RIDE THE MOTORCYCLE

distance of a motorcycle with ABS may be longer than that of an equivalent motorcycle without ABS. Use special caution in such areas.

- ABS will help prevent wheel lock-up when braking in a straight line, but it cannot control wheel slip which may be caused by braking during cornering. When turning a corner, it is better to limit braking to the light application of both brakes or not to brake at all. Reduce your speed before you get into the corner.
- Same as conventional brake system, an excessive sudden braking may cause wheel lock up that makes it harder to control a motorcycle.
- During braking, ABS will not prevent the rear wheel lifting.

WARNING

ABS cannot protect the rider from all possible hazards and is not a substitute for safe riding practices. Be aware of how the ABS system operates and its limitations. It is the rider's responsibility to ride at appropriate speeds and manner for weather, road surface and traffic conditions.

- The computers integrated in the ABS compare vehicle speed with wheel speed. Since non-recommended tires can affect wheel speed, they may confuse the computers, which can extend braking distance.

⚠ WARNING

Use of non-recommended tires may cause malfunctioning of ABS and can lead to extended braking distance. The rider could have an accident as a result. Always use recommended standard tires for this motorcycle.

NOTE

- *ABS indicator light may come on under motorcycle riding condition. (ex. The front or rear wheel races.) In this case, first turn the ignition switch to "OFF," and then back to "ON," and run the motorcycle at the speed of approx. 10 km/h (6 mph) or above. ABS indicator light goes off by this operation, but if it remains lit, you should have the ABS checked by an authorized Kawasaki dealer.*

- *When the ABS is functioning, you may feel a pulsing in the brake lever or pedal. This is normal. You need not suspend applying brakes.*
- *ABS does not function at speeds of approx. 10 km/h (6 mph) or below.*
- *ABS does not function if the battery is discharged.*

Yellow ABS Indicator Light

Normally the ABS indicator light goes on when the ignition switch is turned on and goes off shortly after the motorcycle starts moving.

If this light shows any of the following, a fault or faults may have occurred in the ABS. You should have the ABS checked by an authorized Kawasaki dealer.

- The light does not come on when the ignition switch is turned on.

88 HOW TO RIDE THE MOTORCYCLE

- The light remains lit after the motorcycle starts moving.
- The light comes on and remains lit after the motorcycle starts moving.

Remember that the ABS does not function when this light is on, but if the ABS fails, the conventional brake system still works normally.

Stopping the Engine

- Close the throttle completely.
- Shift the transmission into neutral.
- Turn the ignition key to “OFF.”
- Support the motorcycle on a firm, level surface with the side stand.
- Lock the steering.

NOTE

- *The motorcycle is equipped with a vehicle-down sensor which causes the engine to stop automatically if the*

motorcycle falls down. The engine warning indicator light () blinks when the starter button is pressed if the engine cannot be started. After righting the motorcycle, first turn the ignition key to “OFF” and then back to “ON” before starting the engine.

Stopping the Motorcycle in an Emergency

Your Kawasaki Motorcycle has been designed and manufactured to provide you optimum safety and convenience. However, in order to fully benefit from Kawasaki's safety engineering and craftsmanship, it is essential that you, the owner and operator, properly maintain your motorcycle and become thoroughly familiar with its operation. Improper maintenance can create a

dangerous situation known as throttle failure. Two of the most common causes of throttle failure are:

1. An improperly serviced or clogged air cleaner may allow dirt and dust to enter the throttle body and stick the throttle open.
2. During removal of the air cleaner, dirt is allowed to enter and jam the fuel injection system.

In an emergency situation such as throttle failure, your vehicle may be stopped by applying the brakes and disengaging the clutch. Once this stopping procedure is initiated, the engine stop switch may be used to stop the engine. If the engine stop switch is

used, turn off the ignition switch after stopping the motorcycle.

Parking

WARNING

Operating or parking the vehicle near flammable materials can cause a fire, and can result in property damage or severe personal injury.

Do not idle or park your vehicle in an area where tall or dry vegetation, or other flammable materials could come into contact with the muffler or exhaust pipe.

90 HOW TO RIDE THE MOTORCYCLE

⚠ WARNING

The engine and exhaust system get extremely hot during normal operation and can cause serious burns.

Never touch a hot engine, exhaust pipe, or muffler during operation or after stopping the engine.

- Shift the transmission into neutral and turn the ignition key to “OFF.”
- Support the motorcycle on a firm, level surface with the side stand.

NOTICE

Do not park on a soft or steeply inclined surface, or the motorcycle may fall over.

- If parking inside a garage or other structure, be sure it is well ventilated

and the motorcycle is not close to any source of flame or sparks; this includes any appliance with a pilot light.

⚠ WARNING

Gasoline is extremely flammable and can be explosive under certain conditions, creating the potential for serious burns. Turn the ignition switch to “OFF”. Do not smoke. Make sure the area is well ventilated and free from any source of flame or sparks; this includes any appliance with a pilot light.

- Lock the steering to help prevent theft.

NOTE

- *When stopping near traffic at night, you can leave the turn signals blinking for greater visibility by turning the*

ignition key to the  position and push in the hazard switch.

MAINTENANCE AND ADJUSTMENT

The maintenance and adjustments outlined in this chapter must be carried out in accordance with the Daily Safety Checks and Periodic Maintenance to keep the motorcycle in good running condition and to reduce air pollution. **The initial maintenance is vitally important and must not be neglected.**

WARNING

Failure to perform these checks or to correct a problem before operation may result in serious damage or an accident. Always perform daily safety checks before operation.

With a basic knowledge of mechanics and the proper use of tools, you should be able to carry out many of the maintenance items described in this chapter. If you lack proper experience or doubt your ability, all adjustments, maintenance, and repair work should be completed by a qualified technician.

Please note that Kawasaki cannot assume any responsibility for damage resulting from incorrect or improper adjustment made by the owner.

 **DANGER**

Exhaust gas contains carbon monoxide, a colorless, odorless poisonous gas. Inhaling carbon monoxide can cause serious brain injury or death. **DO NOT** run the engine in enclosed areas. Operate only in a well-ventilated area.

 **WARNING**

The cooling fan spins at high speed and can cause serious injuries. Keep your hands and clothing away from the cooling fan blades at all times.

NOTE

- *If a torque wrench is not available, the maintenance items which require a specific torque value should be serviced by an authorized Kawasaki dealer.*

Daily Safety Checks

Check the following items each day before you ride. The time required is minimal, and habitual performance of these checks will help ensure you a safe, reliable ride.

If any irregularities are found during these checks, refer to the MAINTENANCE AND ADJUSTMENT chapter or see your dealer for the action required to return the motorcycle to a safe operating condition.

Operation	See Page
Fuel Adequate supply in tank, no leaks	–
Engine Oil Oil level between level lines	102
Tires Air pressure (when cold), install the air valve cap Tire Wear	132 133
Drive Chain Slack	117

Operation	See Page
Lubricate if dry	117
Bolt, nuts and fasteners Check for loose and/or missing bolts, nuts and fasteners	—
Steering Action smooth but not loose from lock to lock No binding of control cables	— —
Brakes Brake pad wear Brake fluid level No brake fluid leakage	123 122 —
Throttle Throttle grip play	112
Clutch Clutch lever play Clutch lever operates smoothly	115 —

96 MAINTENANCE AND ADJUSTMENT

Operation	See Page
Coolant No coolant leakage Coolant level between level lines (when engine is cold)	 – 106
Electrical equipment All lights (head, tail/brake, turn signal, warning/indicator) and horn work	 –
Engine stop switch Stops engine	 –
Side stand Return to its fully up position by spring tension Return spring not weak or not damaged	 – –
Rear view mirrors Rear view sight	 73

Periodic Maintenance

- *A: Service at number of years shown or indicated odometer reading intervals, whichever comes first.
- *B: For higher odometer readings, repeat at the frequency interval established here.
- *C: Service more frequently when operating in severe conditions: dusty, wet, muddy, high speed, or frequent starting/stopping.

: Inspection

: Dealer Inspection

: Change or Replace























: Dealer Change or Replace

: Lubrication

: Dealer Lubrication





















98 MAINTENANCE AND ADJUSTMENT

Items	year (*A)	Odometer Reading (*B) × 1 000 km (× 1 000 mile)					See Page
		1 (0.6)	6 (3.8)	12 (7.6)	18 (11.4)	24 (15.2)	
Air cleaner element (*C)					Q		–
		↻: every 36 000 km (22 500 mile)					–
Idle speed		Q		Q		Q	114
Throttle control system (play, smooth return, no drag)	Q:1	Q		Q		Q	112
Engine vacuum synchronization				Q		Q	–
Fuel system	Q:1	Q		Q		Q	–
Fuel hoses	↻:5						–
Coolant level		Q		Q		Q	106
Cooling system	Q:1	Q		Q		Q	–

Items	year (*A)	Odometer Reading (*B) × 1 000 km (× 1 000 mile)					See Page
		1 (0.6)	6 (3.8)	12 (7.6)	18 (11.4)	24 (15.2)	
Coolant, water hose and O-ring	 :3	 : every 36 000 km (22 500 mile)					–
Valve clearance		 : every 42 000 km (26 250 mile)					–
Air suction system							–
Clutch operation (play, engagement, disengagement)							115
Engine Oil and Oil filter (*C)	 :1						103
Tire air pressure	 :1						132
Wheels and tires	 :1						133
Wheel bearing damage	 :1						–
Drive chain lubrication condition (*C)		 : every 600 km (400 mile)					117

100 MAINTENANCE AND ADJUSTMENT

Items	year (*A)	Odometer Reading (*B) × 1 000 km (× 1 000 mile)					See Page
		1 (0.6)	6 (3.8)	12 (7.6)	18 (11.4)	24 (15.2)	
Drive chain slack (*C)		Q: every 1 000 km (600 mile)					117
Drive chain wear (*C)				Q		Q	–
Drive chain guide wear				Q		Q	–
Brake system	Q:1	Q	Q	Q	Q	Q	–
Brake fluid level	Q:0.5	Q	Q	Q	Q	Q	122
Brake fluid (front and rear)	🔄:2					🔄	–
Brake hose/rubber parts of brake master cylinder and caliper	🔄:4	🔄: every 48 000 km (30 000 mile)					–
Brake pad wear (*C)			Q	Q	Q	Q	123
Brake light switch operation		Q	Q	Q	Q	Q	124

Items	year (*A)	Odometer Reading (*B) × 1 000 km (× 1 000 mile)					See Page
		1 (0.6)	6 (3.8)	12 (7.6)	18 (11.4)	24 (15.2)	
Suspension system	 :1						—
Steering play	 :1						—
Steering stem bearings	 :2						—
Electrical system	 :1						—
Spark plugs							—
Chassis parts	 1						—
Condition of bolts, nuts and fasteners							—

102 MAINTENANCE AND ADJUSTMENT

Engine Oil

Oil Level Inspection

- If the engine is cold, start the engine and run it for several minutes at idle speed.
- Stop the engine, then wait several minutes until the oil settles.

NOTICE

Racing the engine before the oil reaches every part can cause engine seizure.

- Check the engine oil level through the oil level inspection window. With the motorcycle held level, the oil level should come up between the upper and lower level lines next to the oil level inspection window.

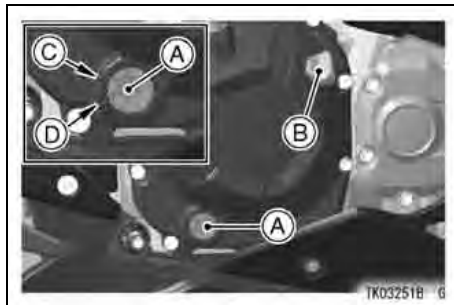

- A. Oil Level Inspection Window
- B. Oil Filler Cap
- C. Upper Level Line
- D. Lower Level Line

- If the oil level is too high, remove the excess oil through the oil filler opening using a syringe or some other suitable device.
- If the oil level is too low, add the oil to reach the correct level. Use the same type and brand of oil that is already in the engine.

Oil and/or Oil Filter Change

- Warm up the engine thoroughly, and then stop it.
- Place an oil pan beneath the engine.
- Remove the engine oil drain plug.

⚠ WARNING

Engine oil is a toxic substance. Dispose of used oil properly. Contact your local authorities for approved disposal methods or possible recycling.

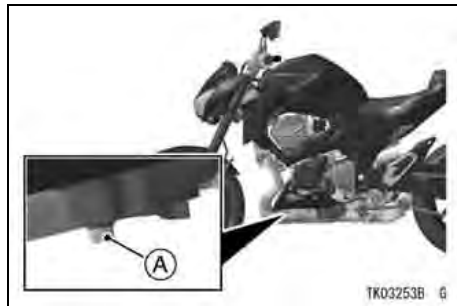
**A. Engine Oil Drain Plug**

- Let the oil completely drain with the motorcycle perpendicular to the ground.
- If the oil filter is to be replaced, remove the oil filter cartridge and replace it with a new one.

104 MAINTENANCE AND ADJUSTMENT

NOTE

- If a torque wrench or required Kawasaki special tool is not available, this item should be serviced by a Kawasaki dealer.

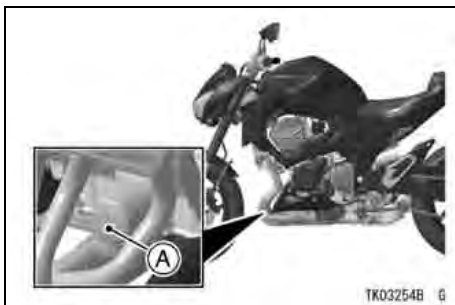
**A. Oil Filter**

- Apply a thin film of oil to the packing and tighten the cartridge to the specified torque.

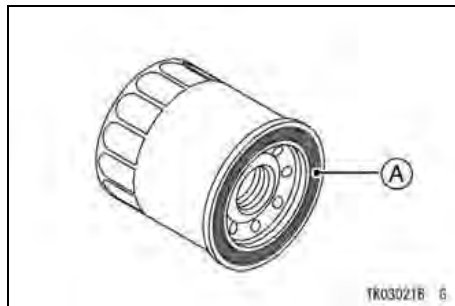
**A. Packing**

- Install the drain plug with a new gasket. Tighten it to the specified torque.

NOTE

- *Replace the gasket with a new one.*
- Fill the engine up to the upper level line with a good quality engine oil specified in the table.
- Start the engine.
- Check the oil level and oil leakage.

Tightening Torque

Engine Oil Drain Plug:

29 N·m (3.0 kgf·m, 21 ft·lb)

Cartridge:

17 N·m (1.7 kgf·m, 13 ft·lb)

Recommended Engine Oil

Type:

API SG, SH, SJ, SL or SM with JASO
 MA, MA1 or MA2 rating

Viscosity:

SAE10W-40

NOTE

- Do not add any chemical additive to the oil. Oils fulfilling the above requirements are fully formulated and provide adequate lubrication for both the engine and the clutch.

Engine Oil Capacity

Capacity: 3.1 L (3.3 US qt)

[when filter is not removed]

3.4 L (3.6 US qt)

[when filter is removed]

Although 10W-40 engine oil is the recommended oil for most conditions, the oil viscosity may need to be changed to accommodate atmospheric conditions in your riding area.

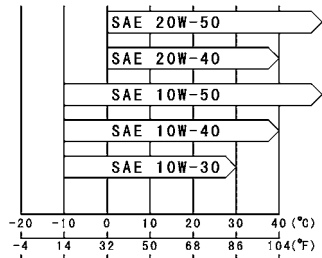

TK03023BZ2 C

Coolant

Coolant Level Inspection

- Position the motorcycle so that it is perpendicular to the ground.
- Check the coolant level through the coolant level gauge on the reserve tank located to the left of the engine. The coolant level should be between the F (Full) and L (Low) level lines.

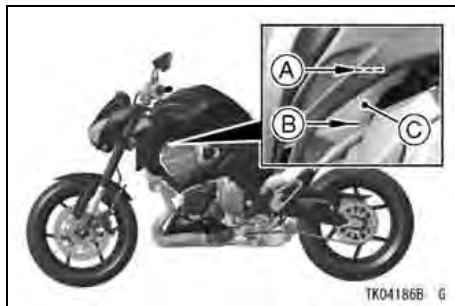

- A. F (Full) Level Line
- B. L (Low) Level Line
- C. Reserve Tank

NOTE

- Check the level when the engine is cold (room or atmospheric temperature).
- If the amount of coolant is insufficient, add coolant into the reserve tank.

Coolant Filling

- Remove the bolts and plastic washers.
- Clear the hooks on the ignition cover and remove it.

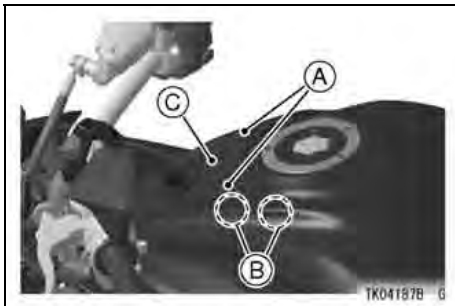

- A. Bolts and Plastic Washers**
- B. Hooks (Both Sides)**
- C. Ignition Cover**

- Clear the projection and tab on the left tank cover.

- Pull the left tank cover forward to clear the hook.

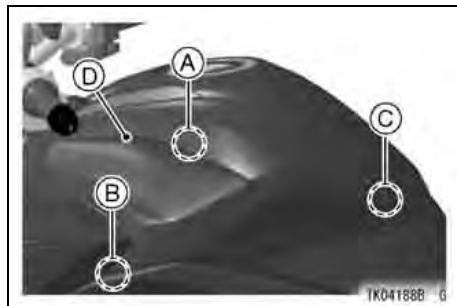

- A. Projection**
- B. Tab**
- C. Hook**
- D. Left Tank Cover**

- Remove the bolts and screws.
- Remove the left inner shroud.

108 MAINTENANCE AND ADJUSTMENT

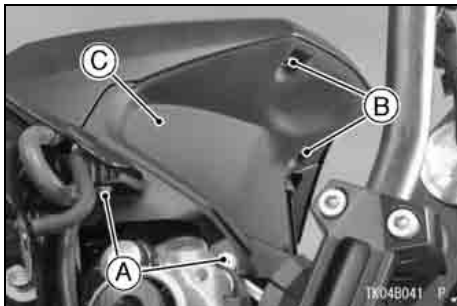

- A. Bolts
- B. Screws
- C. Left Inner Shroud

- Remove the cap from the reserve tank and add coolant through the filler opening to the F (Full) level line.

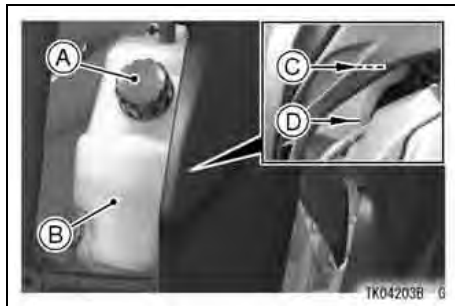

- A. Cap
- B. Reserve Tank
- C. F (Full) Level Line
- D. L (Low) Level Line

- Install the left inner shroud.
- Install the left tank cover so that the hook on the fuel tank fits into the slot.
- Insert the tab on the left tank cover into the slot.
- Insert the projection on the left tank cover into the hole.

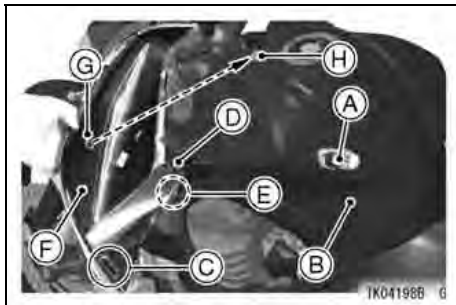

- A. Hook**
- B. Fuel Tank**
- C. Slot**
- D. Tab**
- E. Slot**
- F. Left Tank Cover**
- G. Projection**
- H. Hole**

- Insert the pin on the ignition cover into the hole on the bracket.

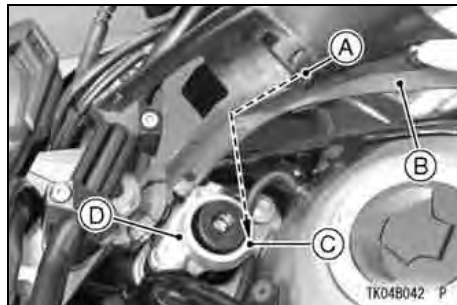

- A. Pin**
- B. Ignition Cover**
- C. Hole**
- D. Bracket**

- Insert the hooks on the ignition cover into the slots.
- Install the ignition cover and install the bolts and plastic washers.

110 MAINTENANCE AND ADJUSTMENT

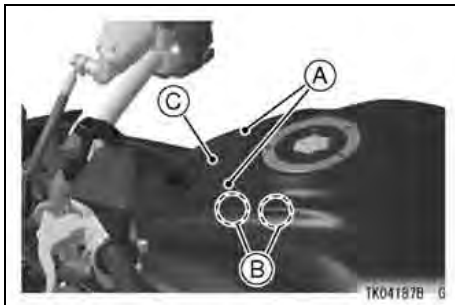

- A. Bolts and Plastic Washers
- B. Hooks (Both Sides)
- C. Ignition Cover

Coolant Change

Have the coolant changed by an authorized Kawasaki dealer.

Coolant Requirement

⚠ WARNING

Coolant containing corrosion inhibitors for aluminum engines and radiators include harmful chemicals for human body. Drinking coolant can result in serious injury or death. Use coolant in accordance with the instructions of the manufacturer.

Use a permanent type of antifreeze (soft water and ethylene glycol plus corrosion and rust inhibitor chemicals for aluminum engines and radiators) in the cooling system. On the mixture ratio of coolant, choose the suitable one referring to the relation between freezing point and strength directed on the container.

NOTICE

If hard water is used in the system, it causes scale accumulation in the water passages, and considerably reduces the efficiency of the cooling system.

NOTE

- A permanent type of antifreeze is installed in the cooling system when shipped. It is mixed at 50% and has the freezing point of -35°C (-31°F).

Air Cleaner

This motorcycle's air cleaner element consists of a dry paper filter. Cleaning and replacement of the air cleaner element should be done by an authorized Kawasaki dealer.

Oil Draining

- Inspect the transparent drain hose located under the left side of the engine to see if any oil has run down.

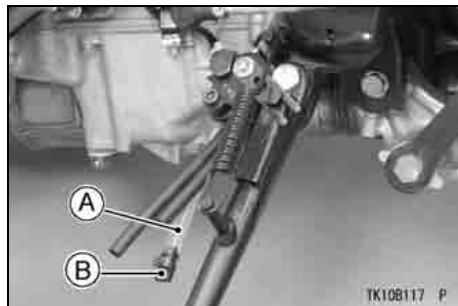

A. Drain Hose

B. Plug

- If there is any oil in the hose, remove the plug from the lower end of the drain hose and drain the oil.

112 MAINTENANCE AND ADJUSTMENT

⚠ WARNING

Oil on tires will make them slippery and can cause an accident and injury. Be sure to install the plug in the drain hose after draining.

Throttle Control System

Throttle Grip

Throttle Grip Free Play Inspection

- Check that the throttle grip moves smoothly from full open to close, and the throttle closes quickly and completely by the return spring in all steering positions.
- If the throttle grip does not return properly, have the throttle control system checked by an authorized Kawasaki dealer.

- Check the throttle grip free play by turning back and forth.

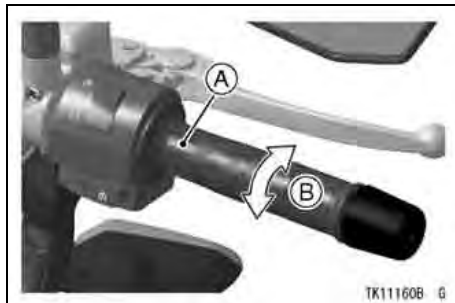

- A. Throttle Grip**
- B. Throttle Grip Play**

Throttle Grip Play

2 ~ 3 mm (0.08 ~ 0.12 in.)

- If there is improper play, adjust it.

Throttle Grip Free Play Adjustment

- Loosen the locknuts at the upper of the throttle cables, and screw both throttle cable adjusters completely so as to give the throttle grip plenty of play.
- Turn out the decelerator cable adjuster until there is no play when the throttle grip is completely closed. Tighten the locknut.

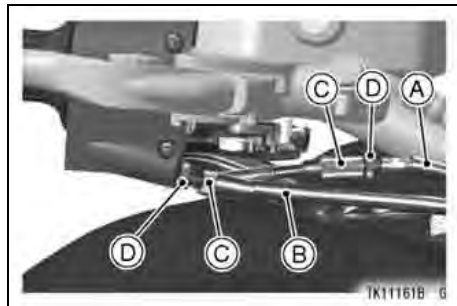

- A. Decelerator Cable**
- B. Accelerator Cable**
- C. Adjusters**
- D. Locknuts**

- Turn out the accelerator cable adjuster until 2 ~ 3 mm (0.08 ~ 0.12 in.) of throttle grip play is obtained. Tighten the locknut.
- If the throttle cables cannot be adjusted with the adjuster at the upper end of the throttle cable, further adjustment of the throttle cables should

114 MAINTENANCE AND ADJUSTMENT

be done by an authorized Kawasaki dealer.

- With the engine idling, turn the handlebar to each side. If handlebar movement changes the idle speed, the throttle cables may be improperly adjusted or incorrectly routed, or they may be damaged. Be sure to correct any of these conditions before riding.

⚠ WARNING

Operation with improperly adjusted, incorrectly routed, or damaged cables could result in an unsafe riding condition. Be sure the control cables are adjusted and routed correctly, and are free from damage.

Idle Speed

Idle Speed Adjustment

- Start the engine, and warm it up thoroughly.
- Adjust the idle speed by turning the idle adjusting screw.

Idle Speed

1 050 ~ 1 150 r/min (rpm)



A. Idle Adjusting Screw

- Open and close the throttle a few times to make sure that the idle speed does not change. Readjust if necessary.
- With the engine idling, turn the handlebar to each side. If handlebar movement changes the idle speed, the throttle cables may be improperly adjusted or incorrectly routed, or they may be damaged. Be sure to correct any of these conditions before riding.

WARNING

Operation with damaged cables could result in an unsafe riding condition. Replace damaged control cables before operation.

Clutch

Clutch Operation Inspection

- Check that the clutch lever operates properly and that the inner cable slides smoothly. If there is any irregularity, have the clutch cable checked by an authorized Kawasaki dealer.
- Check the clutch lever play.

Clutch Lever Play

2 ~ 3 mm (0.08 ~ 0.12 in.)

116 MAINTENANCE AND ADJUSTMENT

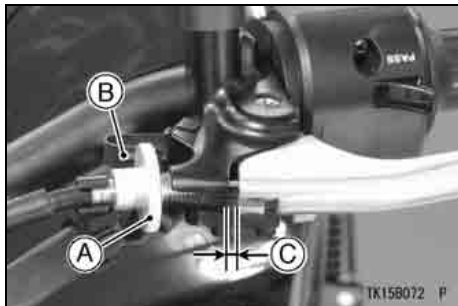

- A. Adjuster
- B. Stopper
- C. Clutch Lever Play

- If the play is incorrect, adjust the lever play as follows.

Clutch Cable Free Play Adjustment

- Loosen the locknut at the clutch lever.
- Turn the adjuster so that the clutch lever will have the specified free play.

⚠ WARNING

Excess clutch cable play could prevent clutch disengagement and cause a crash resulting in serious injury or death. When adjusting the clutch cable, be sure the upper end of the outer cable is fully seated in its fitting so that it doesn't slip into place later and create excessive cable play.

- Tighten the locknut.
- If it cannot be done, adjustment of the clutch free play should be done by an authorized Kawasaki dealer.

NOTE

- *After the adjustment is made, start the engine and check that the clutch does not slip and that it releases properly.*

Drive Chain

Drive Chain Lubrication

Lubrication is necessary after riding through rain or on wet roads, or any time that the chain appears dry.

Use a lubricant for sealed chains to prevent deterioration of chain seals. If the chain is especially dirty, clean it using a cleaner for sealed chains following the instructions supplied by the chain cleaner manufacturer.

- Apply lubricant to the sides of the rollers so that it will penetrate to the rollers and bushings. Apply lubricant to the seals so that the seals will be coated with lubricant. Wipe off any excess lubricant.

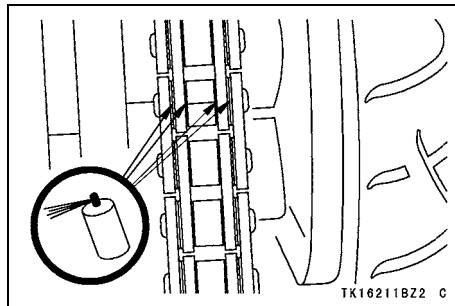

- Wipe off any lubricant that gets on the tire surface.

Drive Chain Slack Inspection

- Set the motorcycle up on its side stand.
- Clean the chain if it is dirty, and lubricate it if it appears dry.
- Rotate the rear wheel to find the position where the chain is tightest, and measure the maximum chain slack by pulling up and pushing down the

118 MAINTENANCE AND ADJUSTMENT

chain midway between the engine sprocket and rear wheel sprocket.

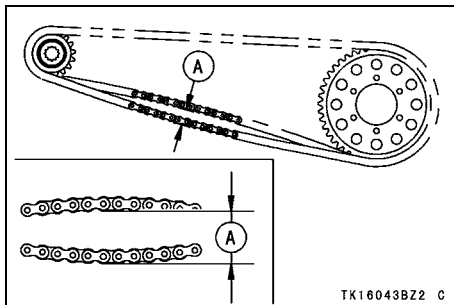

TK16043BZ2 C

A. Chain Slack

- If the drive chain is too tight or too loose, adjust it so that the chain slack is within the standard value.

Drive Chain Slack

Standard: 20 ~ 30 mm (0.8 ~ 1.2 in.)

Drive Chain Slack Adjustment

- Loosen the left and right chain adjuster locknuts.
- Remove the cap.
- Remove the cotter pin, and loosen the axle nut.

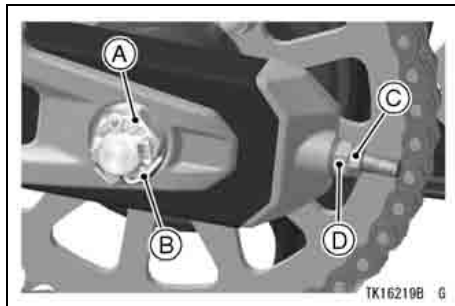

TK16210B G

- A. Axle Nut
- B. Cotter Pin
- C. Locknut
- D. Adjuster Nut

- If the chain is too loose, turn in the left and right chain adjusters evenly.

- If the chain is too tight, turn out the left and right chain adjusters evenly.
- Turn out both chain adjusters evenly until the drive chain has the correct amount of slack. To keep the chain and wheel properly aligned, the notch on the left wheel alignment indicator should align with the same swingarm mark that the right indicator notch aligns with.

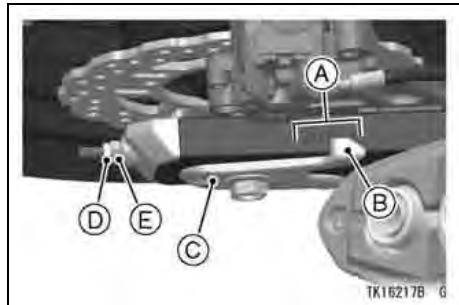

- A. Marks
- B. Notch
- C. Indicator
- D. Locknut
- E. Adjuster Nut

NOTE

- *Wheel alignment can also be checked using the straightedge or string method.*

120 MAINTENANCE AND ADJUSTMENT

⚠ WARNING

Misalignment of the wheel will result in abnormal wear, and may result in an unsafe riding condition. Align the rear wheel using the marks on the swingarm or measuring the distance between the center of the axle and swingarm pivot.

- Tighten both chain adjuster locknuts and the axle nut to the specified torque.

Tightening Torque

Chain Adjuster Locknuts:
16.5 N·m (1.68 kgf·m, 12 ft·lb)
Axle Nut:
108 N·m (11.0 kgf·m, 80 ft·lb)

NOTE

- *If a torque wrench is not available, this item should be serviced by an authorized Kawasaki dealer.*
- Rotate the wheel, measure the chain slack again at the tightest position, and readjust if necessary.
- Install a new cotter pin through the axle nut and axle, and spread its ends.

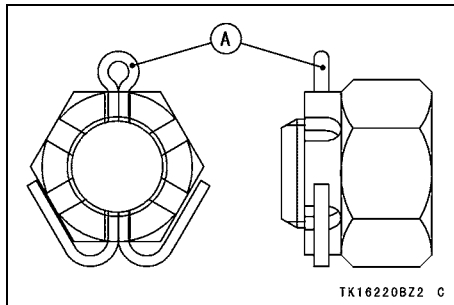

TK16220BZ2 C

A. Cotter Pin

NOTE

- *When inserting the cotter pin, if the slots in the nut do not align with the cotter pin hole in the axle shaft, tighten the nut clockwise up to the next alignment.*
- *It should be within 30 degrees.*
- *Loosen once and tighten again when the slot goes past the nearest hole.*

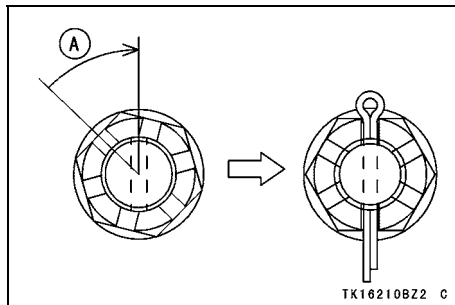

A. Turn Clockwise

⚠ WARNING

A loose axle nut can lead to an accident resulting in serious injury or death. Tighten the axle nut to the proper torque and install a new cotter pin.

- Check the rear brake (see the Brakes section).
- Install the cap.

Brakes

If you feel there is something wrong when applying the brakes, have the brake system checked by an authorized Kawasaki dealer immediately.

⚠ WARNING

Air in the brake lines diminish braking performance and can cause an accident resulting in injury or death. If the brake lever or pedal feels mushy when it is applied, there might be air in the brake lines or the brake may be defective. Have the brake checked immediately by an authorized Kawasaki dealer.

Brake Fluid Level Inspection

- With the front brake fluid reservoir held horizontal, the brake fluid level must be above the lower level line.

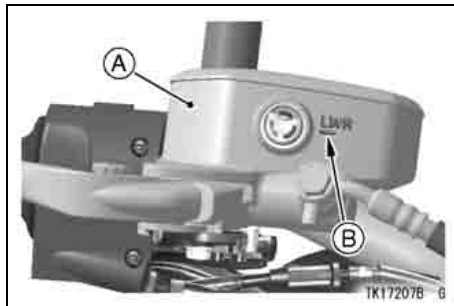

- A. Front Brake Fluid Reservoir
- B. Lower Level Line

- With the rear brake fluid reservoir held horizontal, the brake fluid level must be kept between the upper and lower level lines.

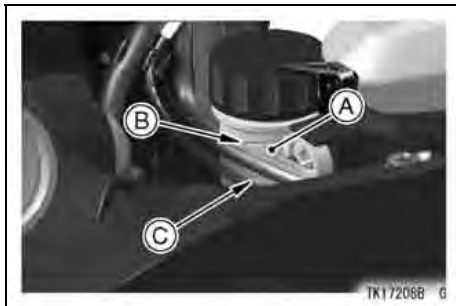

- A. Rear Brake Fluid Reservoir**
- B. Upper Level Line**
- C. Lower Level Line**

- If the fluid level is lower than the lower level line it may indicate that the fluid is leaking. In this case, have the brake system inspected by an authorized Kawasaki dealer.

Brake Pad Wear Inspection

Inspect the brakes for wear. For each front and rear disc brake caliper, if the

thickness of either pad lining is less than below table, replace both pads in the caliper as a set. Pad replacement should be done by an authorized Kawasaki dealer.

Lining Thickness Service Limit

Front	1.0 mm (0.04 in.)
Rear	1.5 mm (0.06 in.)

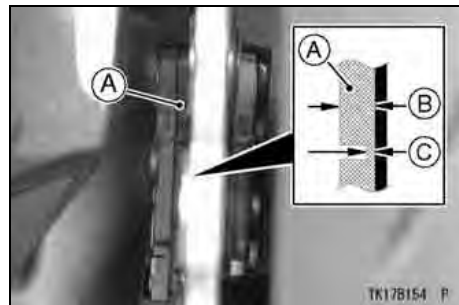

- A. Front Brake Pads**
- B. Lining Thickness**
- C. Service Limit**

124 MAINTENANCE AND ADJUSTMENT

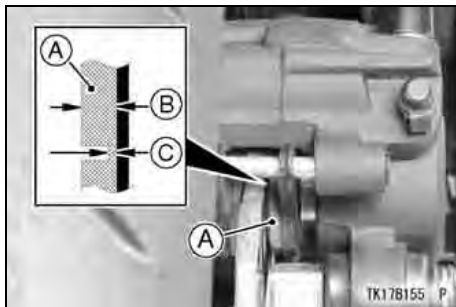

- A. Rear Brake Pads
- B. Lining Thickness
- C. Service Limit

Brake Light Switches

Brake Light Switch Inspection

- Turn the ignition switch on.
- The brake light should go on when the front brake is applied.

- If it does not, ask your authorized Kawasaki dealer to inspect the front brake light switch.
- Check the operation of the rear brake light switch by depressing the brake pedal. The brake light should go on after the proper pedal travel.

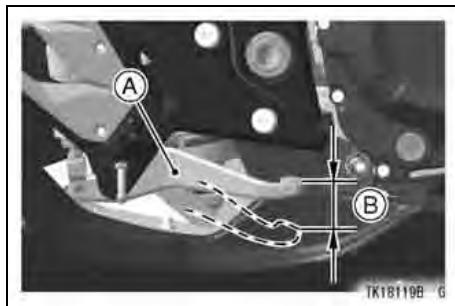

- A. Brake Pedal
- B. 10 mm (0.4 in.)

- If the light does not come on, the rear brake light switch should be adjusted by an authorized Kawasaki dealer.

Brake Pedal Travel

10 mm (0.4 in.)

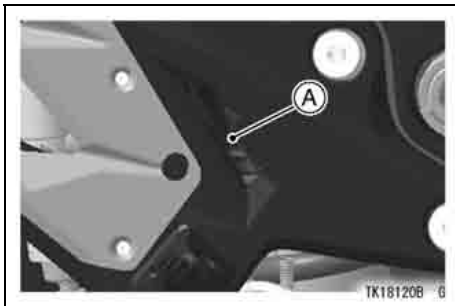

A. Rear Brake Light Switch

NOTICE

To avoid damaging the electrical connections inside the switch, be sure that the switch body does not turn during adjustment.

Suspension System

Front Fork

NOTICE

Do not force to turn the rebound damping force adjuster from the fully seated position, at the adjusting mechanism may be damaged.

126 MAINTENANCE AND ADJUSTMENT***Spring Preload Adjustment***

The adjuster is located at the top of each front fork leg.

Standard

9 mm (0.4 in.)

From the top of the adjuster.

- Turn the spring preload adjuster into the nut to increase spring force and out to decrease spring force. The adjusting range stretches 4 ~ 19 mm (0.2 ~ 0.7 in.) from the top of the adjuster.

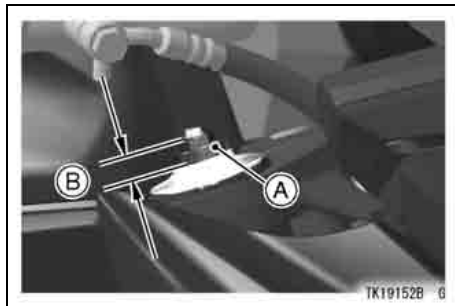

A. Spring Preload Adjuster

B. Adjuster Position

Rebound Damping Force Adjustment

The adjuster is located at the top of right front fork leg.

Standard

12 clicks

Out from the fully seated position (turned fully clockwise).

- Turn the adjuster clockwise with a screwdriver to increase damping force.
- Turn the adjuster counterclockwise to decrease damping force.

NOTICE

Do not turn the adjuster beyond the fully seated position or the adjusting mechanism may be damaged.

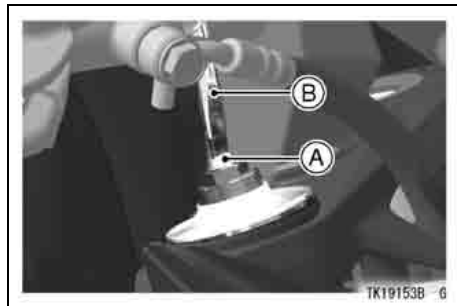

A. Rebound Damping Force Adjuster
B. Screwdriver

Rear Shock Absorber

Spring Preload Adjustment

The spring adjusting nut on the rear shock absorber can be adjusted.

If the spring action feels too soft or too stiff, have it adjusted by an authorized Kawasaki dealer.

128 MAINTENANCE AND ADJUSTMENT***Rebound Damping Force Adjustment***

The adjuster is located at the lower end of the rear shock absorber.

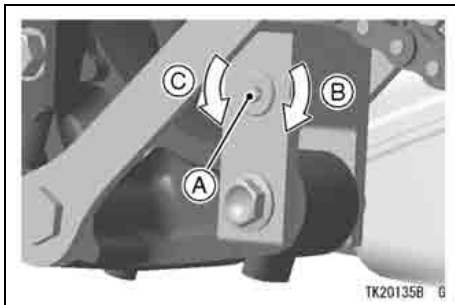

- A.** Rebound Damping Force Adjuster
B. To increase damping force
C. To decrease damping force

Standard

1 1/4 turns out

Out from the fully seated position (turned fully clockwise).

- Turn the adjuster clockwise to increase rebound damping force.
- Turn the adjuster counterclockwise to decrease rebound damping force.

NOTICE

Do not turn the adjuster beyond the fully seated position or the adjusting mechanism may be damaged.

Setting Tables

Front Fork Spring Preload Setting

	Softest setting limit	Standard	Hardest setting limit
Adjuster Position	19 mm (0.7 in.)	9 mm (0.4 in)*	4 mm (0.2 in.)*
Spring Action	Weak	←→	Strong
Setting	Soft	←→	Hard
Load	Light	←→	Heavy
Road	Good	←→	Bad
Speed	Low	←→	High

*: From the top of the adjuster. This adjustment range may not exactly match the number shown in the table due to small tolerance of production.

130 MAINTENANCE AND ADJUSTMENT**Front Fork Damping Force Settings**

		Softest setting limit	Standard	Hardest setting limit
Adjuster Position:	Rebound	26 clicks**	12 clicks**	0*
Damping Force		Weak	←→	Strong
Setting		Soft	←→	Hard
Load		Light	←→	Heavy
Road		Good	←→	Bad
Speed		Low	←→	High

*: This position is the fully seated position (turned fully clockwise).

** : Out from the fully seated position (turned fully clockwise). This adjustment range may not exactly match the number shown in the table due to small tolerance of production.

Rear Shock Absorber Damping Force Settings

		Softest setting limit	Standard	Hardest setting limit
Adjuster Position:	Rebound	2 2/4 turns out**	1 1/4 turns out**	0*
Damping Force		Weak	←→	Strong
Setting		Soft	←→	Hard
Load		Light	←→	Heavy
Road		Good	←→	Bad
Speed		Low	←→	High

*: This position is the fully seated position (turned fully clockwise).

** : Out from the fully seated position (turned fully clockwise). This adjustment range may not exactly match the number shown in the table due to small tolerance of production.

132 MAINTENANCE AND ADJUSTMENT

Wheels

Tire Pressure Inspection

- Remove the air valve cap.
- Check the tire pressure often, using an accurate gauge.
- Make sure to install the air valve cap securely.

NOTE

- Measure the tire pressure when the tires are cold (that is, when the motorcycle has not been ridden more than a mile during the past 3 hours).
- Tire pressure is affected by changes in ambient temperature and altitude, and so the tire pressure should be checked and adjusted when your riding involves wide variations in temperature or altitude.

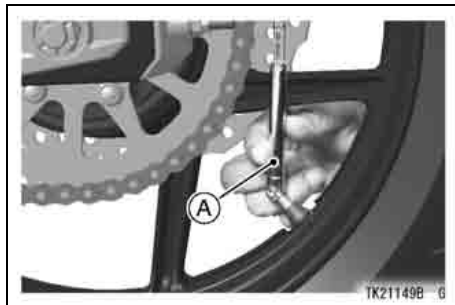
**A. Tire Pressure Gauge****Tire Air Pressure (when cold)**

Front	250 kPa (2.50 kgf/cm ² , 36 psi)
Rear	290 kPa (2.90 kgf/cm ² , 42 psi)

Tire Wear, Damage

As the tire tread wears down, the tire becomes more susceptible to puncture and failure. An accepted estimate is that 90% of all tire failures occur during the last 10% of tread life (90% worn).

So it is false economy and unsafe to use the tires until they are bald.

Tire Wear Inspection

- Measure the depth of the tread with a depth gauge, and replace any tire that has worn down to the minimum allowable tread depth.

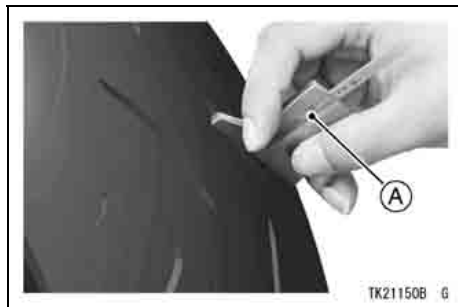

A. Tire Depth Gauge

Minimum Tread Depth

Front	—	1 mm (0.04 in.)
Rear	Under 130 km/h (80 mph)	2 mm (0.08 in.)
	Over 130 km/h (80 mph)	3 mm (0.12 in.)

- Visually inspect the tire for cracks and cuts, replacing the tire in case of bad damage. Swelling or high spots indicate internal damage, requiring tire replacement.

134 MAINTENANCE AND ADJUSTMENT

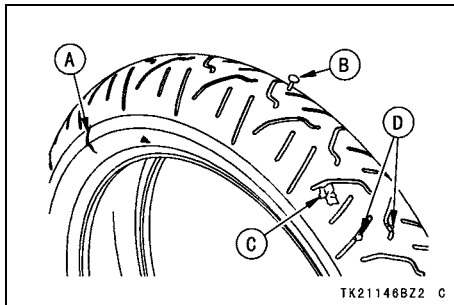

TK21146BZ2 C

- A. Crack or Cur
- B. Nail
- C. Swelling or High spot
- D. Stone

- Remove any imbedded stones or other foreign particles from the tread.

NOTE

- *Have the wheel balance inspected whenever a new tire is installed.*

⚠ WARNING

Tires that have been punctured and repaired do not have the same capabilities as undamaged tires and can suddenly fail, causing an accident resulting in serious injury or death. Replace damaged tires as soon as possible. To ensure safe handling and stability, use only the recommended standard tires for replacement, inflated to the standard pressure. If it is necessary to ride on a repaired tire, do not exceed 100 km/h (60 mph) until the tire is replaced.

NOTE

- *Most countries may have their own regulations requiring a minimum tire tread depth; be sure to follow them.*

- *When operating on public roadways, keep maximum speed under traffic law limits.*

Standard Tire (Tubeless)

Front	Make, Type: DUNLOP, SPORTMAX D214 FJ Size: 120/70ZR17 M/C (58W)
Rear	Make, Type: DUNLOP, SPORTMAX D214 J Size: 180/55ZR17 M/C (73W)

 WARNING

Mixing tire brands and types can adversely affect handling and cause an accident resulting in injury or death. Always use the same manufacturer's tires on both front and rear wheels.

 WARNING

New tires are slippery and may cause loss of control and injury. A break-in period of 160 km (100 miles) is necessary to establish normal tire traction. During break-in, avoid sudden and maximum braking and acceleration, and hard cornering.

Battery

The battery installed in this motorcycle is a sealed type, so it is not necessary to check the battery electrolyte level or add distilled water.

NOTICE

Never remove the sealing strip, or the battery can be damaged. Do not install a conventional battery in this motorcycle, or the electrical system cannot work properly.

Battery Maintenance

It is the owner's responsibility to keep the battery fully charged. Failure to do so can lead to battery failure and leave you stranded.

If you are riding your vehicle infrequently, inspect the battery voltage weekly using a voltmeter. If it drops below 12.6 volts, the battery should be charged using an appropriate charger (check with your Kawasaki dealer). If you will not be using the motorcycle for longer than two weeks, the battery should be charged using an

appropriate charger. Do not use an automotive-type quick charger that may overcharge the battery and damage it.

NOTE

- *Leaving the battery connected causes the electrical components (clock etc) to make the battery discharged, resulting the over discharge of the battery. In this case, the repair or replacement of the battery is not included in the warranty. If you do not drive for four weeks or more, disconnect the battery from the vehicle.*

Kawasaki-recommended chargers are:

Battery Mate 150-9
OptiMate 4
Yuasa MB-2040/2060
Christie C10122S

If the above chargers are not available, use equivalent one.

For more details, ask your Kawasaki dealer.

Battery Charging

- Charge the battery following the instructions of your battery charger.
- The charger will keep the battery fully charged until you are ready to re-install the battery in the motorcycle (see Battery Installation).

⚠ DANGER

Battery acid generates hydrogen gas which is flammable and explosive under certain conditions. It is present within a battery at all times, even in a discharged condition. Keep all flames and sparks (cigarettes) away from the battery. Wear eye protection when working with a battery. In the event of battery acid contact with skin, eyes, or clothing, wash the affected areas immediately with water for at least five minutes. Seek medical attention.

Battery Removal

- Remove the rider's seat, see Rider's Seat Removal in the GENERAL INFORMATION chapter.

138 MAINTENANCE AND ADJUSTMENT

- Clear the hooks on the frame, and remove the rubber band.
- Clear the hook of the fuse box, and remove it.
- Pull up the battery slightly.

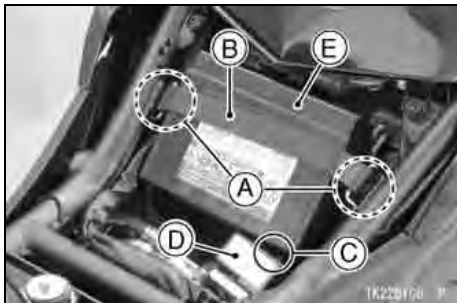

- A. Hooks
- B. Rubber Band
- C. Hook
- D. Fuse Box
- E. Battery

- Slide the red cap from the positive (+) terminal.

- Disconnect the cables from the battery, first from the (-) terminal and then the (+) terminal.

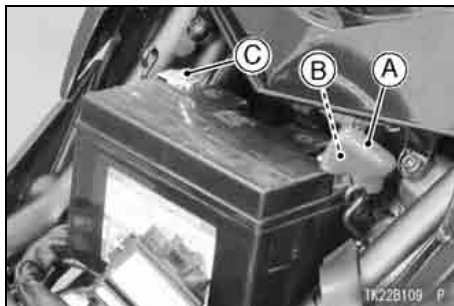

- A. Red Cap
- B. (+) Terminal
- C. (-) Terminal

- Take the battery.
- Clean the battery using a solution of baking soda and water. Be sure that the cable connections are clean.

Battery Installation

- Run the cables outside the battery case and under the main harness.

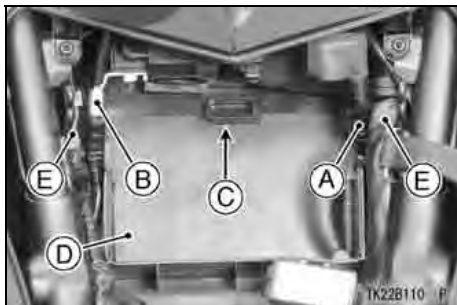

- A. (+) Cable (with Red Cap)
- B. (-) Cable
- C. Projection
- D. Battery Case
- E. Main Harness

- Place the battery on the battery case.
- Connect the (+) cable to the (+) terminal, and then connect the (-) cable to the (-) terminal.

NOTICE

Installing the (-) cable to the (+) terminal of the battery or the (+) cable to the (-) terminal of the battery can seriously damaged the electrical system.

- Put a light coat of grease on the terminals to prevent corrosion.
- Cover the (+) terminal with the red cap.
- Place the battery in the original place so that the battery fits to the projection on the battery case.
- Install the removed parts.

Headlight

Headlight aiming should be done by an authorized Kawasaki dealer.

140 MAINTENANCE AND ADJUSTMENT

Horizontal Adjustment

The headlight beam is adjustable horizontally. If not properly adjusted horizontally, the beam will point to one side rather than straight ahead.

- Turn the horizontal adjuster in or out until the beam points straight ahead.

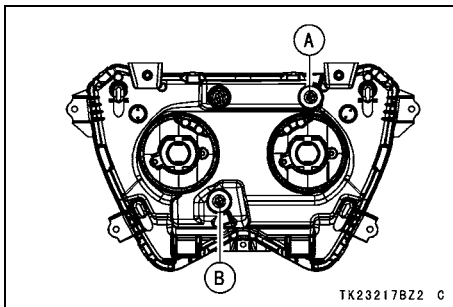

TK23217BZ2 C

A. Horizontal Adjuster

B. Vertical Adjuster

Vertical Adjustment

The headlight beam is adjustable vertically. If adjusted too low, neither low nor high beam will illuminate the road far enough ahead. If adjusted too high, the high beam will fail to illuminate the road close ahead, and the low beam will blind oncoming drivers.

- Turn the vertical adjuster in or out to adjust the headlight vertically.

NOTE

- On high beam, the brightest point should be slightly below horizontal with the motorcycle on its wheels and the rider seated. Adjust the headlight to the proper angle according to local regulations.



Fuses

Fuses are arranged in the fuse boxes located under the rider's seat. The main fuse is located at the battery compartment. If a fuse fails during operation, inspect the electrical system to determine the cause, and then replace it with a new fuse of proper amperage.

If the fuse fails repeatedly, there is something wrong with the electrical

system. Have the motorcycle checked by an authorized Kawasaki dealer.

The main fuse removal should be done by an authorized Kawasaki dealer.

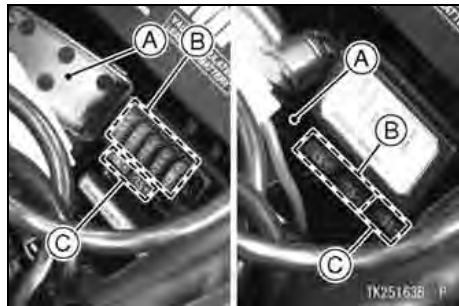

- A. Fuse Box**
- B. Fuses**
- C. Spare Fuses**

142 MAINTENANCE AND ADJUSTMENT

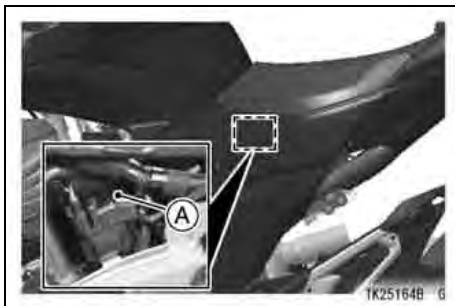

A. Main Fuse

WARNING

Substituting fuses can cause wiring to overheat, catch fire and/or fail. Do not use any substitute for the standard fuse. Replace the blown fuse with a new one of the correct capacity, as specified on the fuse boxes and main fuse.

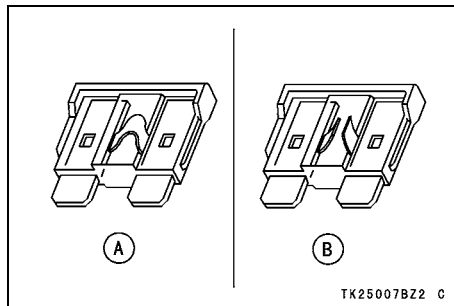

A. Normal
B. Failed

General Lubrication

Lubricate the points shown below, with either engine oil or regular grease, in accordance with the Periodic Maintenance Chart or whenever the vehicle has been operated under wet or rainy conditions.

Before lubricating each part, clean off any rusty spots with rust remover and wipe off any grease, oil, dirt, or grime.

Apply engine oil to the following pivots

- Side Stand
- Clutch Lever
- Front Brake Lever
- Rear Brake Pedal

Lubricate the following cables with a pressure cable luber

- (K) Clutch Inner Cable
- (K) Throttle Inner Cables

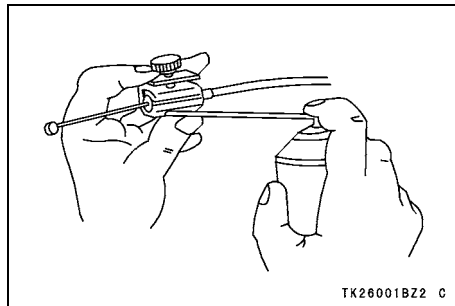

Apply grease to the following points

- (K) Clutch Inner Cable Upper End
- (K) Throttle Inner Cable Upper Ends

(K): Should be serviced by an authorized Kawasaki dealer.

NOTE

- After connecting the cables, adjust them.

Cleaning Your Motorcycle

General Precautions

Frequent and proper care of your Kawasaki motorcycle will enhance its appearance, optimize overall performance, and extend its useful life. Covering your motorcycle with a high quality, breathable motorcycle cover will help protect its finish from harmful UV rays, pollutants, and reduce the amount of dust reaching its surfaces.

WARNING

Build-up of debris or flammable material in and around the vehicle chassis, engine, and exhaust can cause mechanical problems and increase the risk of fire.

When operating the vehicle in conditions that allow debris or flammable material to collect in and around the vehicle, inspect the engine, electrical component and exhaust areas frequently. If debris or flammable materials have collected, park the vehicle outside and stop the engine. Allow the engine to cool, then remove any collected debris. Do not park or store the vehicle in an enclosed space prior to inspecting for build-up of debris or flammable materials.

- Be sure the engine and exhaust are cool before washing.
- Avoid applying degreaser to seals, brake pads, and tires.
- Avoid all harsh chemicals, solvents, detergents, and household cleaning products such as ammonia-based window cleaners.
- Gasoline, brake fluid, and coolant will damage the finish of painted and plastic surfaces: wash them off immediately.
- Avoid wire brushes, steel wool, and all other abrasive pads or brushes.
- Use care when washing the headlight lens, and other plastic parts as they can easily be scratched.
- Avoid using pressure washers; water can penetrate seals and electrical components and damage your motorcycle.
- Avoid spraying water in delicate areas such as in air intakes, fuel

system, brake components, electrical components, muffler outlets, and fuel tank openings.

Washing Your Motorcycle

- Rinse your bike with cold water from a garden hose to remove any loose dirt.
- Mix a mild neutral detergent (designed for motorcycles or automobiles) and water in a bucket. Use a soft cloth or sponge to wash your motorcycle. If needed, use a mild degreaser to remove any oil or grease build up.
- After washing, rinse your motorcycle thoroughly with clean water to remove any residue (residue from the detergent can damage parts of your motorcycle).

146 MAINTENANCE AND ADJUSTMENT

- Use a soft cloth to dry your motorcycle. As you dry, inspect your motorcycle for chips and scratches. Do not let the water air dry as this can damage the painted surfaces.
- Start the engine and let it idle for several minutes. The heat from the engine will help dry moist areas.
- Carefully ride your motorcycle at a slow speed and apply the brakes several times. This helps dry the brakes and restores them to normal operating performance.
- Lubricate the drive chain to prevent rusting.

NOTE

- *After riding in an area where the roads are salted or near the ocean,*

immediately wash your motorcycle with cold water. Do not use warm water as it accelerates the chemical reaction of the salt. After drying, apply a corrosion protection spray on all metal and chrome surfaces to prevent corrosion.

- *Condensation may form on the inside of the headlight lens after riding in the rain, washing the motorcycle or humid weather. To remove the moisture, start the engine and turn on the headlight. Gradually the condensation on the inside of the lens will clear off.*

Radiator

Clean off any obstructions with a stream of low-pressure water.

NOTICE

Using high-pressure water, as from a car wash facility, could damage the radiator fins and impair the radiator's effectiveness. Do not obstruct or deflect airflow through the radiator by installing unauthorized accessories in front of the radiator or behind the cooling fan. Interference with the radiator airflow can lead to overheating and consequent engine damage.

Semi-gloss Finish

To clean the semi-gloss finish;

- When washing the motorcycle, always use a mild neutral detergent and water.
- The semi-gloss finish effect may be lost when the finish is excessively rubbed.
- If any doubt, consult an authorized Kawasaki dealer.

Other Plastic Parts

After washing use a soft cloth to gently dry plastic parts. When dry, treat the headlight lens, and other nonpainted plastic parts with an approved plastic cleaner/polisher product.

NOTICE

Plastic parts may deteriorate and break if they come in contact with chemical substances or household cleaning products such as gasoline, brake fluid, window cleaners, thread-locking agents, or other harsh chemicals. If a plastic part comes in contact with any harsh chemical substance, wash it off immediately with water and a mild neutral detergent, and then inspect for damage. Avoid using abrasive pads or brushes to clean plastic parts, as they will damage the part's finish.

Chrome and Aluminum

Chrome and uncoated aluminum parts can be treated with a chrome/aluminum polish. Coated aluminum

should be washed with a mild neutral detergent and finished with a spray polish. Aluminum wheels, both painted and unpainted can be cleaned with special non-acid based wheel spray cleaners.

Leather, Vinyl, and Rubber

If your motorcycle has leather accessories, special care must be taken. Use a leather cleaner/treatment to clean and care for leather accessories. Washing leather parts with detergent and water will damage them, shortening their life.

Vinyl parts should be washed with the rest of the motorcycle, then treated with a vinyl treatment.

The sidewalls of tires and other rubber components should be treated with a rubber protectant to help prolong their useful life.

 **WARNING**

Rubber protectants can be slippery and, if used on the tread area, cause loss of traction resulting in accident causing injury or death. Do not apply rubber protectant to any tread area.

APPENDIX

Storage

Preparation for Storage

- Clean the entire vehicle thoroughly.
- Run the engine for about five minutes to warm the oil, shut it off, and drain the engine oil.

 WARNING
--

Engine oil is a toxic substance. Dispose of used oil properly. Contact your local authorities for approved disposal methods or possible recycling.

- Put in fresh engine oil.
- Empty the fuel from the fuel tank by the pump or siphon.

 WARNING

Gasoline is extremely flammable and can be explosive under certain conditions, creating the potential for serious burns. Turn the ignition key to "OFF". Do not smoke. Make sure the area is well-ventilated and free from any source of flame or sparks; this includes any appliance with a pilot light. Gasoline is a toxic substance. Dispose of gasoline properly. Contact your local authorities for approved disposal methods.

- Empty the fuel system by running the engine at idle speed until the engine stalls (If left in for a long time, the fuel will break down and could clog the fuel system).

 WARNING

An air/oil mist may be forcibly ejected from the spark plug holes and could get into your eyes. Do not lean over the engine when performing this procedure. If you do get oil in your eyes, wash them immediately with liberal amounts of clean, fresh water and consult a physician as soon as possible.

- Reduce tire pressure by about 20%.
- Set the motorcycle on a box or stand so that both wheels are raised off the ground. (If this cannot be done, put boards under the front and rear wheels to keep dampness away from the tire rubber.)

- Spray oil on all unpainted metal surfaces to prevent rusting. Avoid getting oil on rubber parts or in the brakes.
- Lubricate the drive chain and all the cables.
- Remove the battery, and store it where it will not be exposed to direct sunlight, moisture, or freezing temperatures. During storage it should be given a slow charge (one ampere or less) about once a month. Keep the battery well charged especially during cold weather.
- Tie plastic bags over the muffler to prevent moisture from entering.
- Put a cover over the motorcycle to keep dust and dirt from collecting on it.

Preparation after Storage

- Remove the plastic bags from the muffler.
- Install the battery in the motorcycle and charge the battery if necessary.
- Fill the fuel tank with fuel.
- Check all the points listed in the Daily Safety Checks section.
- Lubricate the pivots, bolts, and nuts.

Troubleshooting Guide

Engine Does Not Start

Starter Motor Won't Turn

- Engine stop switch off
- Transmission not in neutral
- Fuse blown
- Battery leads do not make good electrical contact with battery terminals
- Battery discharged

Engine Cranks, But Won't Start

- No fuel in tank
- Fuel line clogged
- Fuel broken down
- Engine flooded
- Spark plugs not in good contact
- Spark plugs fouled or wet
- Incorrect spark plug gap
- Incorrect valve clearance
- No first turning the ignition switch to "OFF" when the motorcycle falls down.

Engine Stalls

Just When Shifting Into 1st Gear

- Side stand has been left down
- Clutch does not properly disengage

While Riding

- No fuel in tank
- Fuel tank air vent is obstructed
- Overheating
- Battery discharged

Owner Satisfaction

(For Products Sold in Australia Only)

Your satisfaction is important to your authorized Kawasaki dealer and to Kawasaki Motors Pty., Ltd. If you have a problem concerning warranty or service, please take the following action:

Contact the owner and/or service manager of your authorized Kawasaki dealer. Fully explain your problem and ask for assistance in resolving the situation. The OWNER of the dealership is an independent business person and is concerned

with your satisfaction and your future business. For this reason the owner is in the best position to assist you. Also, all warranty and service matters are handled and resolved through the authorized Kawasaki dealer network.

If you are unsatisfied after working with your Kawasaki dealer and feel you still require further assistance, WRITE to the address below. Please be certain to provide the model, product identification number, mileage or hours of use, accessories, dates that events occurred and what action has been taken by both you and your dealer. Include the name and address of the dealership. To assist us in resolving your inquiry, please include copies of related receipts and any other pertinent information including the names of the dealership personnel with whom you have been working in the resolution of your problem.

Upon receipt of your WRITTEN correspondence we will contact the dealership and work with them in resolving your problem.

In order to provide a permanent record, all warranty and service resolutions take place only through WRITTEN correspondence.

Please send your correspondence to:

Customer Relations:

Technical Service Department
KAWASAKI MOTORS Pty., Ltd.
Private Mail Bag 24
RYDALMERER N.S.W. 2116
A.C.N.: 002 840 315

Environmental Protection

To help preserve the environment, properly discard used batteries, tires, oils and fluids, or other vehicle components that you might dispose of in the future. Consult your authorized Kawasaki dealer or local environmental waste agency for their proper disposal procedure. This also applies to disposal of the entire vehicle at the end of its life.

MAINTENANCE RECORD

Owner Name.....

Address

Phone Number

Engine Number

Vehicle Number.....

Key Code

Selling Dealer Name

Phone Number

Warranty Start Date

Note: Keep this information and a spare key in a secure location.

Date	Odometer Reading	Maintenance Performed	Dealer Name	Dealer Address

158 MAINTENANCE RECORD

Date	Odometer Reading	Maintenance Performed	Dealer Name	Dealer Address

Date	Odometer Reading	Maintenance Performed	Dealer Name	Dealer Address

160 MAINTENANCE RECORD

Kawasaki Z800 Owner's Manual

Date	Odometer Reading	Maintenance Performed	Dealer Name	Dealer Address

Date	Odometer Reading	Maintenance Performed	Dealer Name	Dealer Address

162 MAINTENANCE RECORD

Kawasaki Z800 Owner's Manual

Date	Odometer Reading	Maintenance Performed	Dealer Name	Dealer Address

ZR800AD

ZR800BD



* 9 9 9 8 6 - 1 7 0 4 *



KAWASAKI HEAVY INDUSTRIES, LTD.

Motorcycle & Engine Company

Part No. 99986-1704

<http://www.motorcycle.in.th>

Printed in Thailand

GB