



Cary 50

Operation manual

Installation Category I

Pollution Degree 2

Safety Class 3 (EN61010-1)



Publication No. 85 101596 00

October 1997

Varian offices

Varian has offices in most countries. The major offices for optical spectroscopy products are listed below:

Varian Australia Pty Ltd (Manufacturing site)

679 Springvale Road
Mulgrave, Victoria 3170
Australia

International telephone: + 61 3 9560 7133

International fax: + 61 3 9560 7950

Varian Instruments

505 Julie Rivers Road, suite 150
Sugar Land Texas 77478

Telephone: 1 800 926 3000

International telephone: + 1 713 240 7330

International fax: + 1 713 240 6752

Varian International A.G.

Kollerstrasse 38

CH-6300 Zug

Switzerland

International telephone: + 41 41 749 88 44

International fax: + 41 41 740 3340

Internet

The Varian Internet home page can be found at:

<http://www.varian.com>

Varian Australia Pty Ltd is the owner of copyright on this document and any associated software. Under law, the written permission of Varian Australia Pty Ltd must be obtained before either the documentation or the software is copied, reproduced, translated or converted to electronic or other machine-readable form, in whole, or in part.

First published October 1997 in Australia. Comments about this manual should be directed to the Marketing Communications Manager, Varian Australia at the address above or email uv@osi.varian.com.

Varian Australia is ISO9001 certified.

© 1997 Varian Australia Pty Ltd (A.C.N. 004 559 540)

All rights reserved



Declaration of Conformity

We hereby Declare that the equipment
listed below complies with the requirements of:-
The Low Voltage Directive 73/23/EEC (93/68/EEC)
The EMC Directive 89/336/EEC (92/31/EEC and 93/68/EEC)

Applicable Standards

LVD	BS EN 61010-1:1993		
EMC	BS EN55011:1991	BS EN 50081-1:1992	BS EN 50082-1:1992
	IEC 801-2:1991	IEC 801-3:1984	IEC 801-4:1988

Equipment Model Number Cary 50 Series

Responsible Person in the EU.

Print Name: W. David Lowe	Company Name	Varian Ltd
Signed: <i>W. David Lowe</i>	Address	28 Manor Road Walton-on-Thames Surrey KT12 2QF UK
Position: Managing Director	Telephone	(1932) 898 000
Date: 25-08-97	Facsimile	(1932) 228 769

Manufacturer

Print Name: Gregory Davis	Company Name	Varian Australia Pty Ltd
Signed: <i>Gregory Davis</i>	Address	679 Springvale Road Mulgrave VIC 3170 AUSTRALIA
Position: Managing Director	Telephone	(03) 9560 7133
Date: 25-08-97	Facsimile	(03) 9560 7950

varian 

Publication number 85 101595 00 08/97

This page is intentionally left blank.

Contents

Safety practices and hazards	(vii)
1 Introduction	1-1
1.1 Installation requirements	1-1
1.2 Cary documentation	1-1
1.3 Specifications	1-2
1.3.1 Environmental	1-2
1.3.2 Personal computer	1-3
1.3.3 Connections	1-3
1.3.4 Weights and dimensions	1-3
2 Installation	2-1
2.1 Sample holders	2-2
2.1.1 Single Cell Holder	2-2
2.1.2 Other sample holders	2-5
3 Maintenance	3-1
3.1 Cleaning	3-1
3.2 Lamp module	3-2
3.2.1 Lamp module replacement	3-2
3.2.2 Aligning the source mirror	3-3
4 Troubleshooting	4-1
4.1 LED power indication	4-1
4.2 Hard disk power supply connection	4-1
4.3 Input/Output hardware conflict	4-2
4.4 Interrupt hardware conflict	4-3

4.5	No free Interrupt request	4-4
4.6	Instrument offline	4-5
4.7	Instrument performance testing	4-6
5	Spare parts	1
5.1	Panels and covers	1
5.2	Sample holders	1
5.3	Miscellaneous	2

Safety practices and hazards

Your Varian Cary instrument and accessories have been carefully designed so that when used properly you have an accurate, fast, flexible and safe analytical system.

If the equipment is used in a manner not specified by the manufacturer, the protection provided by the equipment may be impaired.

Information on safety practices appears throughout the documentation (both hard copy and on-line) provided with your instrument and accessories. Before using the instrument or accessories, you must thoroughly read these safety practices.

Observe all relevant safety practices at all times.

Lamp module

The lamp is enclosed in a self-contained module. This module contains components operating at high voltages. To avoid electric shock, NEVER disassemble the module.

When operating, the lamp module emits high intensity light which can cause serious damage to eyes. To avoid eye damage, never operate the lamp outside the instrument.

Electrical hazards

The Cary 50 is powered by the personal computer (PC) controlling the instrument. The safe operation of the instrument depends on the integrity of the switching power supply of the PC. Your PC must comply with IEC 60950.

Panels, covers and modules

The only module you are permitted to remove is the lamp module (on the underside of the instrument). The screws you need to undo to remove this module are indicated by white circles.

The only panel you are permitted to remove is the snap out panel covering the lamp mirror adjustment screws on the front of the instrument.

Any other panels or covers which are retained by screws on the spectrophotometer and accessories may be opened **ONLY** by Varian-trained, Varian-qualified, or Varian-approved service engineers. Consult the manuals or product labels supplied with your PC, monitor and printer/plotter to determine which parts are operator-accessible.

Operators and other unauthorized personnel are permitted access **ONLY** to the lamp module and the sample compartment of the Cary. **ALWAYS** switch off the PC before changing a lamp.

Note that the safety classification is given as Class 3 (EN 61010-1).

Other precautions

Do not block any ventilation grills present on the PC. Consult the manuals supplied with your PC, monitor and printer/plotter for their specific ventilation requirements.

Use of the Cary system and accessories may involve materials, solvents and solutions which are flammable, corrosive, toxic or otherwise hazardous.

Careless, improper, or unskilled use of such materials, solvents and solutions can create explosion hazards, fire hazards, toxicity and other hazards which can result in death, serious personal injury, and damage to equipment and property.

ALWAYS ensure that laboratory safety practices governing the use, handling and disposal of such materials are strictly observed. These safety practices should include the wearing of appropriate safety clothing and safety glasses.

Warnings and Cautions

Other specific warnings and cautions appear in this manual and in the on-line help where appropriate, and will detail the specific hazard, describe how to avoid it, and specify the possible consequences of not heeding the warning or caution.

Warning

A 'Warning' message appears in the manual when failure to observe instructions or precautions could result in death or injury. Symbols depicting the nature of the specific hazard are also placed alongside warnings.

Caution

A 'Caution' message is used when failure to observe instructions could result in damage to equipment (Varian supplied and/or associated equipment).

A 'Note' is used to give advice or information.

Read all warnings and cautions carefully and observe them at all times.

A triangular symbol indicates a warning. The meanings of the symbols that may appear alongside warnings in the documentation are as follows:



Electrical shock



Eye hazard



Noxious gases



Fire hazard



Broken glass



Corrosive liquids

Heavy weight
(danger to feet)Heavy weight
(danger to hands)

The following symbol may be used on warning labels attached to the instrument. When you see this symbol you must refer to the relevant operation or service manual for the correct procedure referred to by that warning label.



Power indicator

The green indicator lamp on the front of the Cary 50 indicates the instrument is powered up (i.e. the PC is switched on) and is in normal/standby condition. When the indicator lamp is flashing this indicates the instrument is busy.

Information symbols

The following symbols appear on the Cary 50 to provide you with additional information:



Attached to the rear of the product, and indicates that the product complies with the requirements of one or more EU Directives



Attached to the rear of the product, and indicates that the product has been certified (evaluated) to CSA 1010.1 and UL 3101-1.

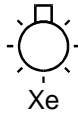

Indicates high voltage Xenon flash lamp present



Indicates viewing hole to check the operation of the Xenon flash lamp

Federal Communications Commission advisory

The following is a Federal Communications Commission advisory:

Caution

This equipment generates, uses, and can radiate radio frequency energy and if not installed and operated in accordance with the instruction manual, may cause interference to radio communications. It has been tested and found to comply with the limits for a Class A computing device pursuant to Subpart J of Part 15 of FCC Rules, which are designed to provide reasonable protection against such interference when operated in a commercial environment. Operation of this equipment in a residential area may cause interference in which case the user at his or her own expense will be required to take whatever measures may be required to correct the interference.

CE Compliant Products

Cary instruments have been designed to comply with the requirements of the Electro-magnetic Compatibility (EMC) Directive and the Low Voltage (electrical safety) Directive (commonly referred to as the LVD) of the European Union.

Varian has confirmed that each product complies with the relevant Directives by testing a prototype against the prescribed EN (European Norm) standards.

Proof that a product complies with the Directives is indicated by:-

- the CE Marking appearing on the rear of the product
- the documentation package that accompanies the product containing a copy of the Declaration of Conformity. This Declaration is the legal declaration by Varian that the product complies with the Directives, and also shows the EN standards to which the product was tested to demonstrate compliance.

It is also signed by Varian's Authorized Representative in the EU, and by the representative of the manufacturing plant.

This page is intentionally left blank.

1 Introduction

1.1 Installation requirements

Prior to receiving your instrument you will have been provided with a Cary Pre-installation manual, which describes the environmental and operating requirements of the Cary system. You must prepare your laboratory according to these instructions before the Cary can be installed. You should keep the Pre-installation manual for future reference. If you have misplaced your copy, you can obtain a replacement from your local Varian office.

1.2 Cary documentation

You have been provided with the following documentation to help you set up and operate your Cary 50 system:

- Installation Guide, with information on unpacking the instrument, installing the interface card in the PC and setting up the system
- This operation manual, with Safety practices and hazards information, instructions for installing and maintaining the components of the Cary 50, and hardware-related troubleshooting information
- Cary WinUV software manual, with instructions for installing the Cary WinUV software, an overview of the software and software related troubleshooting information
- Extensive on-line Help (provided with the Cary WinUV software) containing context-sensitive help, step-by-step instructions for frequently performed analyses and instructions for using any accessories you ordered.

Conventions

The following conventions have been used throughout the documentation:

- ❑ *Italics* indicate menu items, menu options and field names (e.g. select *Copy* from the *Edit* menu).
- ❑ Keyboard and mouse commands have been typed in **bold** (e.g. press the **F2** key).
- ❑ Single quotes (' ') indicate a selection you can make from several choices, such as radio buttons and checkboxes.
- ❑ Double quotes (" ") are used to signify the pushbuttons appearing throughout the software (e.g. select "OK").
- ❑ ALL CAPITALS indicates text you must type in from the keyboard (e.g. type SETUP at the prompt).

1.3 Specifications

Your Cary instrument is designed for indoor use. It is suitable for the categories stated on the front of this manual.

1.3.1 Environmental

Condition	Altitude	Temp t (°C)	Humidity (%RH) non-condensing
Non-operating (transport)	0-2133 m (0-7000')	5-45	20-80
Operating but not necessarily meeting performance specifications	0-2000 m (0-6562')	5-31 31-40	≤80 ≤{80-3.33(t-31)}
Operating within performance specifications	0-853 m (0-2800')	10-35	8-80
	853-2133 m (2800-7000')	10-25	8-80

For optimum analytical performance it is recommended that the ambient temperature of the laboratory be between 20-25 °C and be held constant to within ±2 °C throughout the entire working day.

1.3.2 Personal computer

To ensure safe operation of the instrument, the switching power supply in the PC must comply with standard IEC 60950.

PC power supply

The power requirements of the Cary 50 must be met by the PC power supply and the following capacity is required:

+5V DC <1A

+12V DC <1.5 A

-12V DC <0.25 A,

a total of 26 W.

Allowance must also be made for external accessories powered by +12V DC.

1.3.3 Connections

3.5 mm phono jack socket in the left hand side of the sample compartment for accessories.

8-pin DIN connector in the left hand side of the sample compartment for the diode detector.

25-pin D-range connector in the right hand side of the sample compartment for accessories (optional).

1.3.4 Weights and dimensions

Weight

Packed 23 kg (50.7 lb)

Unpacked 21 kg (46 lb)

Dimensions (W x D x H)

Packed 615 x 710 x 360 mm (24 x 28 x 14 in)

Unpacked 490 x 500 x 200 mm (19 x 20 x 8 in)

This page is intentionally left blank.

2 Installation

The Cary 50 is designed to be completely customer-installable. Instructions for setting up the Cary system are included in the Installation Guide supplied with the instrument.



Warning

The Cary 50 weighs over 20 kg. To avoid injury to personnel or damage to equipment, always use two or more people when lifting or carrying the instrument. NEVER attempt to lift the instrument alone.

Following the instructions in the Installation Guide you should have:

- Unpacked the spectrophotometer and placed it on the intended workbench
- Installed the instrument interface card in the PC (if you supplied your own PC)
- Connected the instrument to the PC
- Connected the PC to the power supply
- Installed the software
- Completed the instrument performance tests.

This chapter describes how to install the sample holders used with the Cary 50. Instructions for installing/replacing the lamp module are included in the next chapter.



Figure 2-1 Cary 50 showing the sample compartment lid (1) and front panel (2)

2.1 Sample holders

2.1.1 Single Cell Holder

The Single Cell Holder enables you to measure a single sample in the Cary 50 spectrophotometer. It is mounted onto the cell holder base supplied with the Cary 50.

The cell holder base and Single Cell Holder are shipped installed in the sample compartment of the Cary 50. To remove the Single Cell Holder loosen thumbscrew (item 4 in Figure 2-2) and lift the Single Cell Holder off the cell holder base. To remove the cell holder base loosen its thumbscrew (item 2 in Figure 2-2) and remove the cell holder base from the sample compartment. Alternatively you can leave the Single Cell Holder on the cell holder base and remove them from the sample compartment as one item. Simply undo the thumbscrew on the cell holder base and remove the base and cell holder assembly from the instrument.

Installation

Refer to Figure 2-2 when installing the Single Cell Holder.

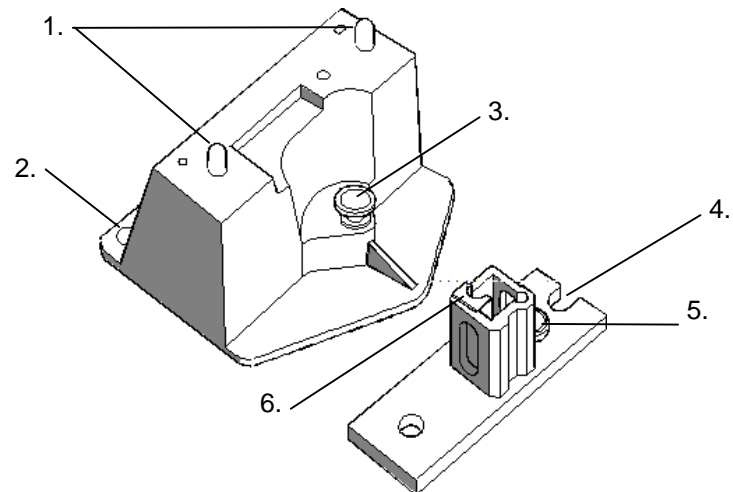

Figure 2-2 Cell holder base (left) and Single Cell Holder

- | | |
|--------------------------------|-------------------|
| 1. Locating pins | 2. Locating holes |
| 3. Cell holder base thumbscrew | 4. Notch |
| 5. Cell holder thumbscrew | 6. Cell lifter |

To install the Single Cell Holder:

1. Slide back the sample compartment lid and remove the front panel by sliding it straight up until it is clear of the instrument.
2. If not already fitted, install the cell holder base as follows:
 - (a) Hold the cell holder base with the locating holes facing towards you.
 - (b) Place the cell holder base in the sample compartment, aligning the two locating holes over the two raised knobs in the floor of the sample compartment.
 - (c) Firmly tighten the thumbscrew at the rear of the cell holder base by hand.
3. Hold the Single Cell Holder so the notched section is to the right and place it on the cell holder base, aligning the holes in the Single Cell Holder over the locating pins on the cell holder base (see Figure 2-2).
4. Tighten the thumbscrew on the Single Cell Holder.

You should now align the Single Cell Holder, as described in the following section.

Alignment

To align the Single Cell Holder:

1. Place a cell in the Single Cell Holder (if the cell has ground glass sides or sides featuring the Cary logo, hold the cell by these sides and ensure one of these sides is facing you as you put the cell in the Single Cell Holder).



Note The cell holder is tight - you will need to push the cell in firmly.

2. Start the Align application by pressing "Start" in the Windows Taskbar and selecting Programs/Cary WinUV/Align.
3. Press the "Setup" button or select *Setup* from the menu.
4. In the Goto Wavelength group, set the wavelength to 0 nm (white light) by enabling the Zero Order checkbox.
5. Press "OK". (The green power indicator on the instrument should start flashing to indicate that the instrument is active.)
6. Place a piece of white paper in the light path to the right of the Single Cell Holder, and note where the light beam strikes the paper. The light beam should appear as though it will pass through the sample.



Note You may need to dim the room lights to see the light beam.

7. If you only have a small volume of sample and the beam is not striking the sample, raise the height of the cell as follows:
 - (a) Raise the cell lifter and remove the cell from the Single Cell Holder
 - (b) Adjust the screw underneath the Cell Holder accordingly using the supplied hexagonal ball driver
 - (c) Replace the cell in the Single Cell Holder and check that the beam strikes the sample. Repeat the height adjustment if necessary.

The Single Cell Holder is now ready for use.

Operation

To use the Single Cell Holder:

1. Place the cell in the Single Cell Holder.
2. Set the instruments parameters according to your analytical requirements (refer to the on-line help for details).
3. Commence the measurement.



Note The sample compartment lid may be left open during sample measurement.

2.1.2 Other sample holders

Other sample holders are available for use with the Cary 50, such as the Microcell Holder and Solid Sample Holder. Instructions for their use are included in the on-line help provided with the Cary WinUV software. Refer to the Cary WinUV manual (part number 85 101625 00) for details on using the on-line help.

This page is intentionally left blank.

3 Maintenance

This chapter includes the maintenance procedures for the Cary 50 that may be carried out by an operator. Any maintenance procedures not specifically mentioned in this chapter should be carried out only by Varian-trained, Varian-qualified or Varian-authorized service engineers.



Warning

This instrument contains an intense light source. Direct viewing of the light source will cause eye damage. Operators and other unauthorized personnel must NEVER remove the main cover.



Note This section refers only to maintenance procedures for the Cary spectrophotometer. You should refer to your PC and printer manuals for their maintenance procedures.

3.1 Cleaning

Any spills in the sample compartment should be wiped up immediately.

The exterior surfaces of the Cary spectrophotometer should be kept clean. All cleaning should be done with a soft cloth. If necessary, this cloth can be dampened with water or a mild detergent. Do not use organic solvents or abrasive cleaning agents.

3.2 Lamp module

This section describes how to replace the lamp module and re-align the light beam. Before changing the lamp module, ALWAYS switch the PC off.



Note These instructions are also provided on-line with the Cary WinUV software, together with video to demonstrate the procedure. Refer to the Cary WinUV manual (publication number 85 101625 00) for details on using the on-line help.

3.2.1 Lamp module replacement

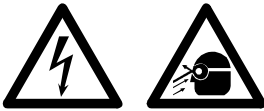

Warning

When operating, the lamp module emits high intensity light which can damage eyes. To avoid eye damage, never operate the lamp module outside the instrument.

The lamp module contains components operating at high voltages. To avoid electric shock, NEVER disassemble the lamp module.

To remove the lamp module:

1. Switch off the PC and remove the plug from the 'inst' connector on the rear panel of the Cary 50.
2. Turn the Cary onto its side to give access to the base.
3. Undo and remove the six screws marked by the white solid circles on the lamp module cover using a star headed screw driver. As you remove the last screw, use one hand to support the lamp module.
4. Hold the lamp module out from the instrument and unplug the 3 pin connector from the Cary 50. Discard the lamp module.

To fit a new lamp module:

1. Plug the 3 pin connector of the new lamp module into the instrument.
2. Fit the lamp module in the base of the Cary 50 ensuring that the wiring is kept clear of the other parts of the instrument.
3. Replace and tighten the six screws.
4. Return the instrument to its upright position and replace the cable at the rear.
5. Turn the PC back on.

3.2.2 Aligning the source mirror

For optimum performance of the instrument, the source mirror should be aligned to suit the new lamp module.

To align the source mirror:

1. Start the Align application by pressing the "Start" button in the Windows Taskbar and selecting Programs/Cary WinUV/Align.
2. Press "Setup" or select *Setup* from the menu and set the following parameters:
 - (a) Single beam mode, Normal
 - (b) %T
 - (c) 500 nm
3. Press "OK".
4. Remove the snap-out panel (see Figure 3-1) from the front of the instrument, using a flat blade screwdriver to pry the panel open. This exposes the two source mirror adjustment screws.



Note Do not remove the plastic bung next to the adjustment screws.



Figure 3-1 The snap-out panel (1) on the front of the Cary 50

5. In the Align window (see Figure 3-2), monitor the Current Signal bar as you use the supplied hexagonal wrench to slowly adjust one of the adjustment screws at the front of the instrument. If the length of the Current Signal bar decreases, slowly turn the screw in the other direction. (You can expect to

see some fluctuation due to noise). If the signal is out of range or excessively weak or strong, press "Rescale" to bring the signal back into range for display. Continue to adjust the screw until the length of the Current Signal bar is maximized. When the length of the Current Signal bar is at its greatest, repeat for the other adjustment screw.



Note It does not matter in which order the adjustment screws are aligned.

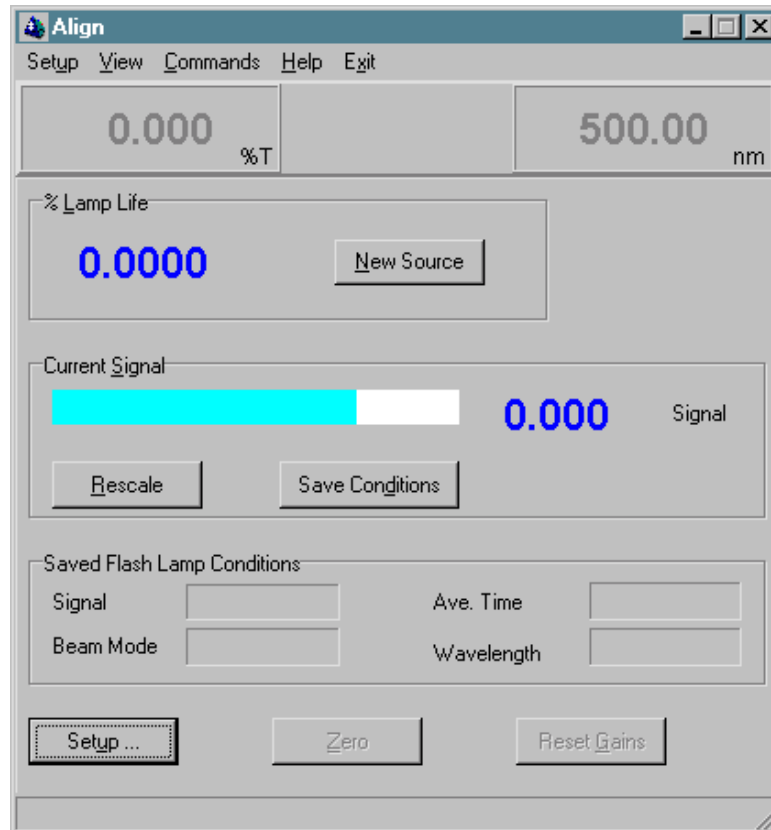

Figure 3-2 Align window

5. Replace the snap out panel on the front of the instrument.
The source mirror is now aligned and the instrument is ready for use.

4 Troubleshooting

This chapter contains troubleshooting information to help you solve various problems you may encounter when setting up or using your Cary 50.

4.1 LED power indication

The Cary 50 is powered directly from the PC power supply. A green power indicator light on the front of the Cary 50 indicates when the instrument is powered.

Problem

The power indicator on the Cary 50 does not light when the PC is switched on.

Solution

Check the connection of the main instrument cable connecting the PC to the Cary 50.

If the power indicator on the front of the Cary 50 is still not on, check the connection of the PC power supply connector to the Cary 50 card inside the PC. Instructions for the connection of the power supply connector are listed in the Installation Guide supplied with your Cary 50 (and in the next section if you need to use a Y connector).

4.2 Hard disk power supply connection

Problem

There is not a spare hard disk power supply connector in the PC.

Solution

With the Disposable Grounding Wrist Strap (supplied with the Cary 50) fitted, plug the appropriate end of the supplied Y connector (see Figure 4-1) into the connector at the end of the Cary 50 PC card. Unplug a hard disk power supply connector and connect it to the Y connector. Connect the free end of the Y connector to the hard disk.

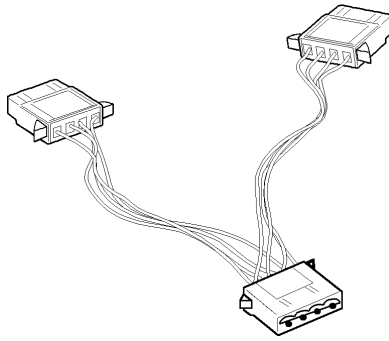

Figure 4-1 Y connector supplied with the Cary 50

4.3 Input/Output hardware conflict

Problem

A warning message regarding device conflicts appears when you start the PC after installing the Cary 50 Hardware device driver. This occurs when one (or more) device in the system tries to use the same Input/output resource.

Solution

Reboot the PC. If the message still appears it will be necessary to change the I/O address used by the conflicting device, since the I/O address of the Cary 50 card is fixed at 0210 - 021F.

To change the I/O address of the conflicting device:

1. Press "Start" in the Windows Taskbar.
2. Select Settings/Control Panel/System.
3. Select the Device Manager tab.
4. Expand 'Other devices' and select Varian Cary 50. The conflicting device will appear in the Conflicting device list. Press "Cancel" to return to the Device Manager tab.
5. Locate the conflicting device in the list and double click on it.
6. On the Resources tab (see Figure 4-2), deselect the 'Use automatic settings' and change the Input/Output address until the message "No Conflicts" appears in the Conflicting device list.

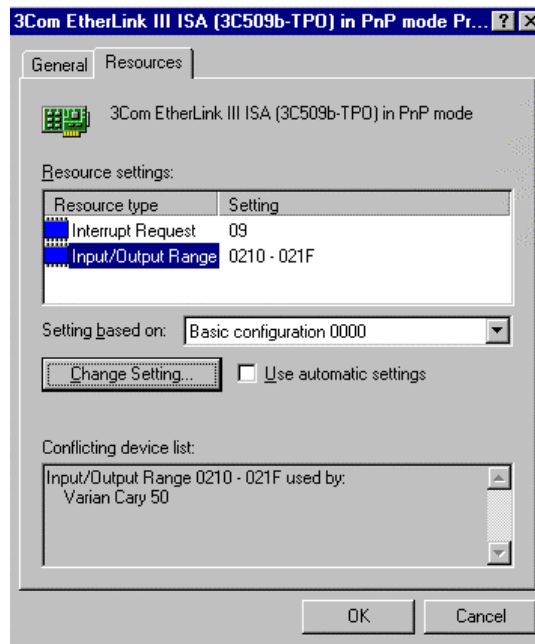

Figure 4-2 Example of Input/Output address conflict with the Cary 50

4.4 Interrupt hardware conflict

Problem

A warning message regarding device conflicts appears when you start the PC. This occurs when one or more devices in the system tries to use the same Interrupt resource.

Solution

Reboot the PC. If the message still appears there may be an Interrupt conflict. The Cary 50 interface card uses one of the following Interrupt requests (IRQ): 3, 5, 7, 10, 11, 12.

If you have an Interrupt conflict it will be necessary to change the Interrupt setting of the Cary 50 to an unused setting.

To change the Interrupt of the Cary 50 interface card:

1. Press "Start" in the Windows Taskbar.
2. Select Settings/Control Panel/System.
3. Select the Device Manager tab.

4. Expand 'Other devices' and select Varian Cary 50. The conflicting device will be listed in the Conflicting device list.
5. On the Resources tab (see Figure 4-3), deselect 'Use automatic settings' and change the Interrupt request of the Cary 50 until the message "No Conflicts" appears in the Conflicting device list.

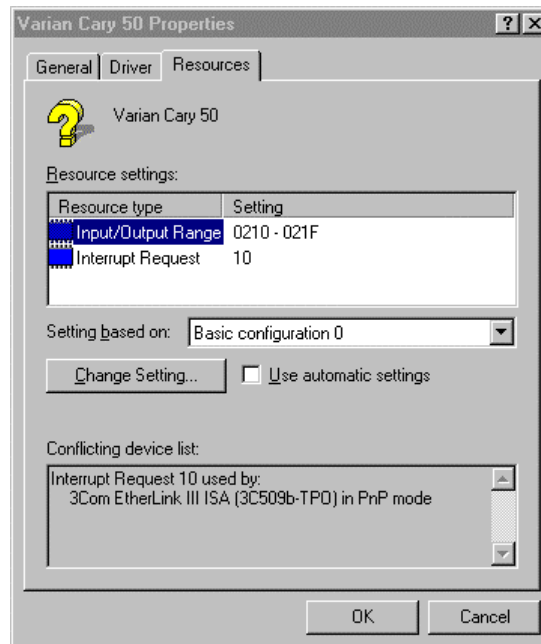

Figure 4-3 Example of Interrupt conflict with the Cary 50

4.5 No free Interrupt request

Problem

There is not a spare Interrupt request available for the Cary 50.

Solution

Disable a device which you do not use frequently, for example a sound card.

To disable the device:

1. Press "Start" in the Windows Taskbar.
2. Select Settings/Control Panel/System.
3. Select the Device Manager tab.

4. Double click on the device you want to disable.
5. On the General tab, disable the 'Original Configuration' checkbox (see Figure 4-4).

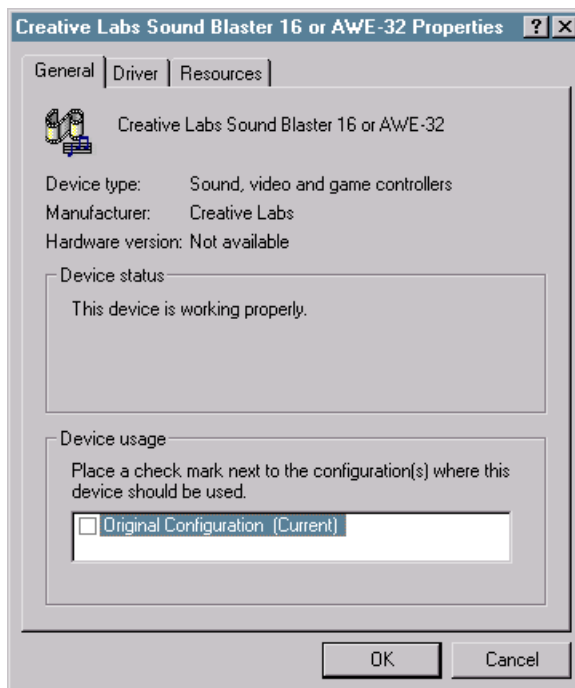

Figure 4-4 Disabling a device to free an Interrupt request for the Cary 50

4.6 Instrument offline

Problem

When the Cary WinUV software is started the application reports that the instrument is "Offline".

Solution

Check the connection of the main instrument cable connecting the PC to the Cary 50.

4.7 Instrument performance testing

Problem

The results of your instrument performance tests do not meet specifications (the results obtained during factory testing are included in the packing crate with the instrument).

Solution

Check the following:

- The sample compartment is empty.
- The cable connecting the instrument to the PC is correctly connected and the retaining screws are tightened.
- The lamp is pulsing during initialization. This is indicated if the green power indicator on the front of the instrument flashes (you should also hear the monochromator and the filter wheel moving). You should also turn the instrument on its side and look through the small lamp viewing hole in the base of the instrument. If the lamp is not pulsing you may have a hardware conflict (see sections 4.3/4.4).
- The lamp is correctly aligned (refer to Chapter 3 for instructions on aligning the lamp).



Warning

When operating, the lamp module emits high intensity light which can damage eyes. To avoid eye damage, never operate the lamp module outside the instrument.

The lamp module contains components operating at high voltages. To avoid electric shock, NEVER disassemble the lamp module.

5 Spare parts

The following spare parts are available for use with your Cary 50 instrument. Always use Varian-supplied spare parts, unless otherwise indicated.

5.1 Panels and covers

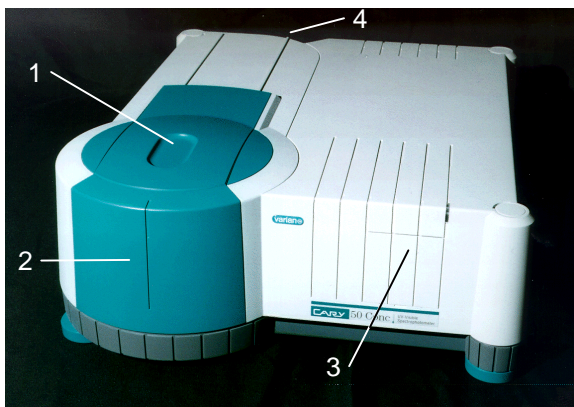

1. Sample compartment lid	09 101272 00
2. Sample compartment front panel	01 106429 90
3. Lamp mirror adjustment cover	09 101274 00
4. Accessory cable port plate (rear of instrument)	09 101240 00

5.2 Sample holders

Cell holder base (supplied as standard and is the supporting base for all compatible cell holders)	01 106481 90
Single Cell Holder (supplied as standard with Cary 50 Scan, Bio and Conc systems)	01 102601 90

Microcell Holder (supplied as standard with Cary 50 Bio systems)	01 106450 90
Solid Sample Holder	00-100723-00
Ordering details for other Cary 50 accessories are available in the Parts and Supplies catalog included on-line with the Cary WinUV software.	
Accessory Cable Kit (needed to interface certain accessories such as the Temperature Probe on the Cary 50)	99 100943 00

5.3 Miscellaneous

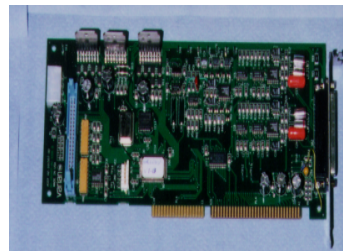

Lamp module assembly (left) and Cary 50 PC card (right)

Lamp module assembly	01 106396 90
PWB Cary 50/PC Interface card	02 101557 90
Cary 50/PC interconnecting cable	01 106373 90
Star head screw driver	72 100279 00
Hexagonal wrench (2.5 mm)	72 100281 00
3M Disposable Grounding Wrist Strap	79 100313 00
Cary Mouse Pad	79 100223 00