

StorageLoader 2U LTO

Quick Start Guide

Accessories — These accessories are included with your library

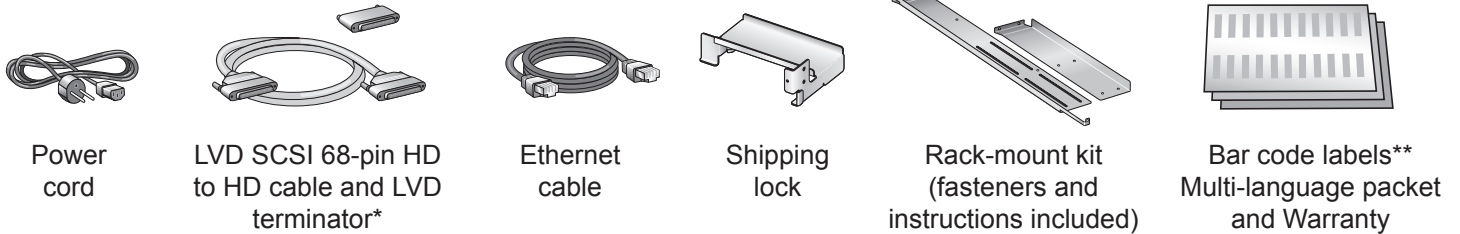



* LVD SCSI configuration only. **Important:** Both LTO-2 and LTO-3 tape drives require Ultra 160 rated SCSI cabling, and an Ultra 3 or LVD 160 Active SCSI terminator. The StorageLoader 2U LTO ships from the factory with these accessories.

** To prepare your own labels, refer to the Tandberg Data Bar Code Label Specification for LTO Cartridges available at: www.tandbergdata.com.

Additional Items — You must have -or- obtain some or all the following items to complete the installation

Host computer with adapter card installed You need a host computer with a host bus adapter card installed. Refer to the documentation that came with the computer and LVD SCSI or Fibre Channel (FC) adapter card. The StorageLoader 2U LTO is configured for LVD SCSI or Fibre Channel. **Important:** Both LTO-2 and LTO-3 tape drives are Ultra 160 SCSI devices and require a minimum Ultra 160 non-RAID SCSI host bus adapter card (LVD SCSI configuration only).

Hybrid cable If your SCSI controller has a 68-pin VHDCI connector, you will need to obtain a VHDCI-to-HD SCSI cable.

 HD Connector
 VHDCI Connector

Tools You will need a #1 Phillips screwdriver.

Fibre Channel cable If you have a Fibre Channel adapter card installed, you need to obtain a FC cable.

Power cord (for use outside Europe) If you plan to use the library outside Europe, you must supply your own power cord (see the Product Manual at www.tandbergdata.com for information about an International 220 VAC power cord).

Backup software You need a backup software application to manage your backup operations. Refer to the documentation that came with the backup software and make sure it supports the library. See www.tandbergdata.com for compatibility information.

Data and Cleaning cartridges (available from Tandberg Data or your supplier)

Tape Drive	Ultrium 3 (slate blue)		Ultrium 2 (purple)		Ultrium 1 (black)		LTO Ultrium Cleaning Cartridge
	Read	Write	Read	Write	Read	Write	
LTO-3	Yes	Yes	Yes	Yes	Yes	No	Yes
LTO-2	No	No	Yes	Yes	Yes	Yes	Yes

WARNING! The library weighs 44 lbs (20 kg). Two people are needed to move or lift the library. Most of the weight is toward the back of the library.

WARNUNG! Die Library wiegt 20 kg. Es sind mindestens 2 Personen erforderlich, um die Library zu bewegen oder zu heben. Der hintere Teil der Library hat das Größte Gewicht.

¡PRECAUCIÓN! La biblioteca montada sobre bastidor pesa 20 kg. Se necesitan dos personas para mover o levantar la biblioteca. La parte trasera de la biblioteca es la de mayor peso.

Step 1 — Before you begin

- 1 — Ensure that you have all the required items before you proceed (see Accessories and Additional Items on page 1).
- 2 — Locate an appropriate area for the unit that has adequate clearance for ventilation, minimal dust and debris, and an appropriate power source. The unit is designed for installation in a standard 4 post, 19-inch rack.
- 3 — Ensure that the work area is free from conditions that could cause electrostatic discharge (ESD). Discharge static electricity from your body by touching a known grounded surface, such as a computer's metal chassis.
- 4 — The unit must be operated in the horizontal position. Do not place it on its side, and do not place objects on top of it.

Step 2 — Unpacking

- 1 — Remove foam ① and accessories:

- ② LVD SCSI cable and terminator*
- ③ Barcode labels and warranty
- ④ Ethernet cable
- ⑤ Power cables
- ⑥ Rack mount kit

- 2 — Lift unit **only by the 2 sides** 

*LVD SCSI configuration only

Important: Save all original packing materials in case you need to ship or move the library later.

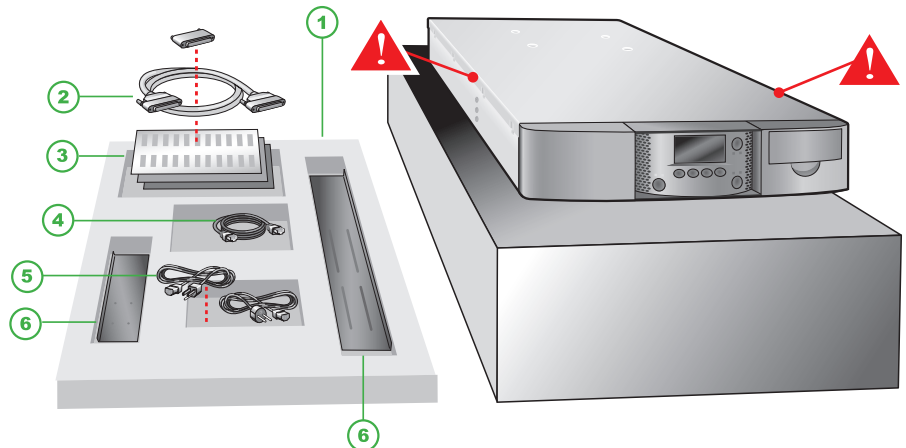
**Step 2a — Rack-mounting (optional)**

If you plan to install the library in a rack, see the Rack-mount Instructions (complete prior to Step 3).





WARNING! Before performing any installation or maintenance procedures, be sure that the library power switch is in the off position and that the power cord is disconnected from the library and the outlet.

WARNUNG! Vor der Ausführung von Installations- oder Wartungsarbeiten ist darauf zu achten, daß der Library-Netzschalter auf "Aus" gestellt ist und daß das Anschlußkabel vom Library und der Steckdose entfernt ist.

¡PRECAUCIÓN! Antes de realizar cualquier procedimiento de instalación o de mantenimiento, comprobar que el interruptor de alimentación de la biblioteca está apagado y que el cable de alimentación no está enchufado ni a la biblioteca ni a la toma de corriente.

Step 3 — Connecting the cables**SCSI connections (LVD only):**

- 1 — Connect SCSI cable  and Terminator* 
- 2 — Connect Power cord 

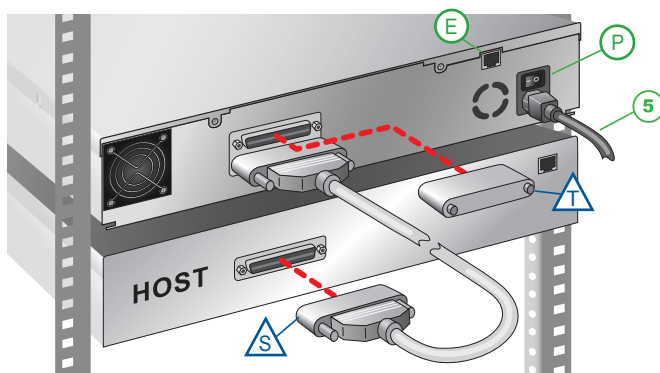
**Fibre Channel connections:**

- 1 — Connect Fibre Channel cable 
- 2 — Connect Power cord 

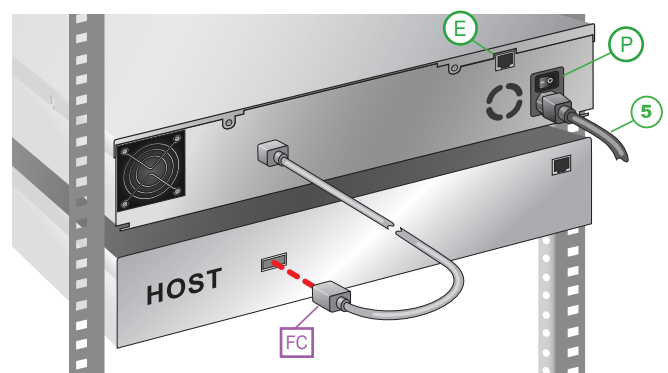

 Power switch (Off=0 On=1)  Ethernet port (see Product Manual for addressing; the default setting is DHCP enabled)

Important: Both LTO-2 and LTO-3 tape drives require Ultra 160 rated SCSI cabling, and an Ultra 3 or LVD 160 Active SCSI terminator to function properly on the SCSI bus. An inadequate terminator will result in various SCSI bus issues, including bus hangs and Read/Write failures. See the "Troubleshooting" chapter of the Product Manual for additional information.

Step 4 — *Powering on and Removing the Shipping Lock*

- 1 — Power on the library by pressing the power switch on the back of the unit (press the **I**).

When you apply power with the shipping lock installed, the library displays a message and ejects both left magazines.

- 2 — Pull the left magazine *straight* out of the library.
- 3 — Power the library off (press the **0**).
- 4 — Remove the screw securing the shipping lock.

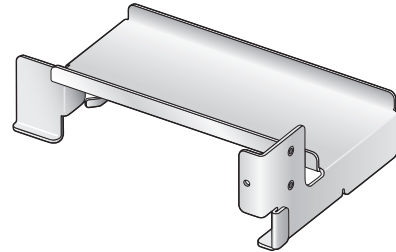
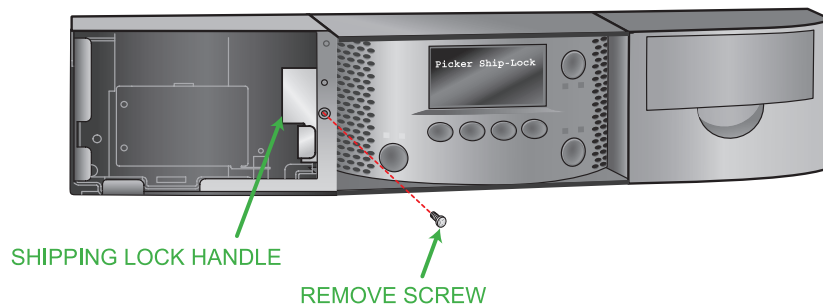
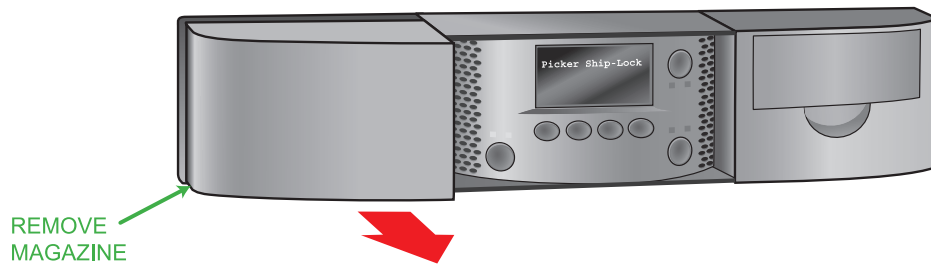
**Shipping Lock**

Step 4 continued — *Powering on and Removing the Shipping Lock*

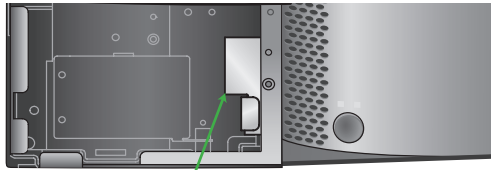

LOCK HANDLE

TOP VIEWS FOR REFERENCE ONLY

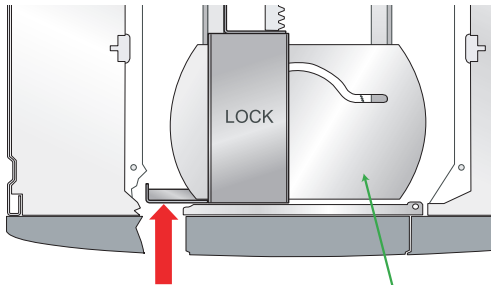

5 — PUSH LOCK HANDLE TO ROTATE ROBOT

ROBOT IN LOCKED POSITION

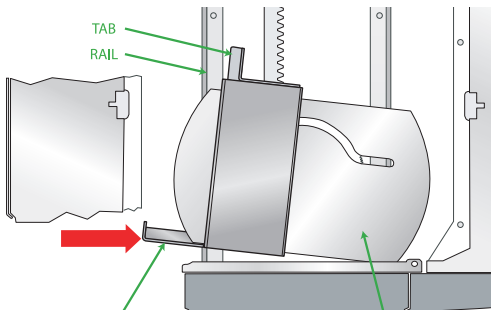

5a — PUSH LOCK HANDLE TO THE RIGHT

ROTATED ROBOT IN UNLOCKED POSITION

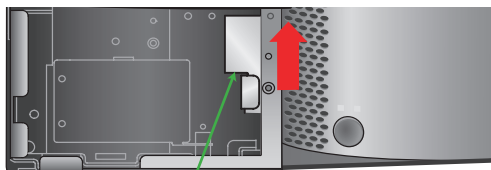

5b — LIFT AND ROTATE LOCK

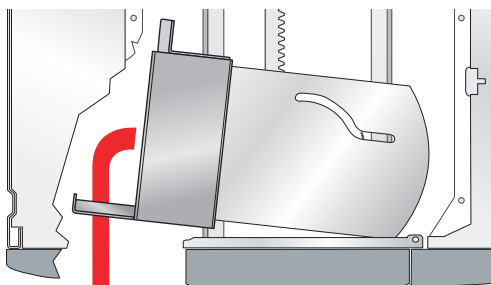

5c — REMOVE SHIPPING LOCK

Important: Some views show the library with the top cover removed for clarity —DO NOT remove the top cover or you will void your warranty!

5 — Rotate the robot by pushing the lock handle toward the back of the library. This moves the locking “tab” out from under the rail.

a. Gently push the lock handle to the right approximately 1 inch (2.5cm).

Important: If you do not remove (rotate and lift) the shipping lock as described in steps b and c, you can catch and damage cables inside the library and render it useless.

b. Rotate the *back* of the lock up toward the top of the library 2 inches (5cm), and then *lift* the front of the lock up 2 inches (5cm).

c. Slowly pull the shipping lock out of the opening.

6 — Slide the left magazine *straight* back into the library.

7 — Power the library on (press the I).

8 — Power the host computer on.

Reinsert the screw in the shipping lock and store them with these instructions in case you need to move or ship the library later.

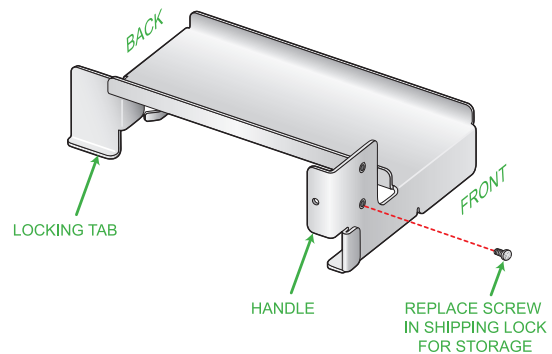

Step 5 — Adding bar code labels and loading cartridges

- 1 — Apply bar code labels to cartridges.
- 2 — Press the eject button to unlock the magazine (magazine releases and moves a short distance out of the library). *This may take a few minutes.*
- 3 — Pull the magazine straight out of the library (no side-to-side or up/down motion).
- 4 — Load cartridges in slots as shown.
Note: The last two slots in each magazine are blocked.
- 5 — Slide the loaded magazine back into the library. The library performs an inventory after the magazine is installed.

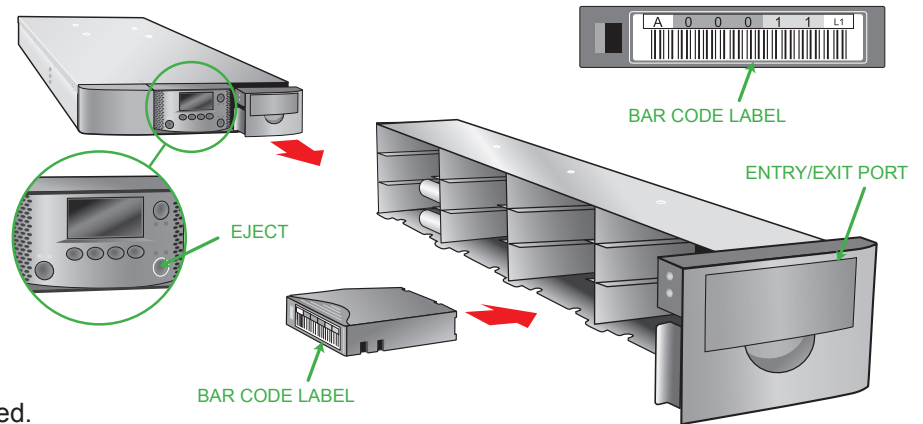

Note: Refer to the Product Manual for important information about the cleaning slot location and the I/E port.

Step 6 — Verifying the hardware installation

- 1 — Download and install **LibTool** and **LTOTool** onto your Host (select the version for your operating system). Available at www.tandbergdata.com.
- 2 — Use **LibTool** to:
 - Detect the library
 - View the library's cartridge inventory
 - Move tapes into and out of the tape drive
- 3 — Use **LTOTool** to:
 - a. Detect the tape drive
 - b. Perform a Read/Write test

Note: The *readme* files that accompany **LibTool** and **LTOTool** provide instructions.

**Preparing for and Performing a Backup**

Congratulations! You have successfully installed your new library! We recommend that you follow these steps:

- 1 — **Read Exabyte's Basic Backup Guide**, which is available at: www.tandbergdata.com.
- 2 — **Select and install a backup application.** Software compatibility information is available at: www.tandbergdata.com.
- 3 — **Perform a backup.** For questions regarding software installation, configuration, or operation (including how to perform a backup) — contact your software provider.

Note: 1) Driver installation may not be necessary and depends on the backup application that you use in your system. Refer to the installation instructions for your backup application for verification.
2) You can configure the library for a customized operation to fit your particular needs. See the Product Manual at www.tandbergdata.com.

Home Screen Menu and Buttons

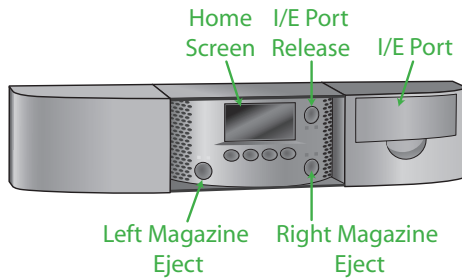

Home Screen Buttons	Function
OK	Accept the change
Select	Accept the choice
Back	Return to previous screen

Exterior Buttons	Function
I/E Port	Unlock I/E Port
Magazine	Unlock magazine

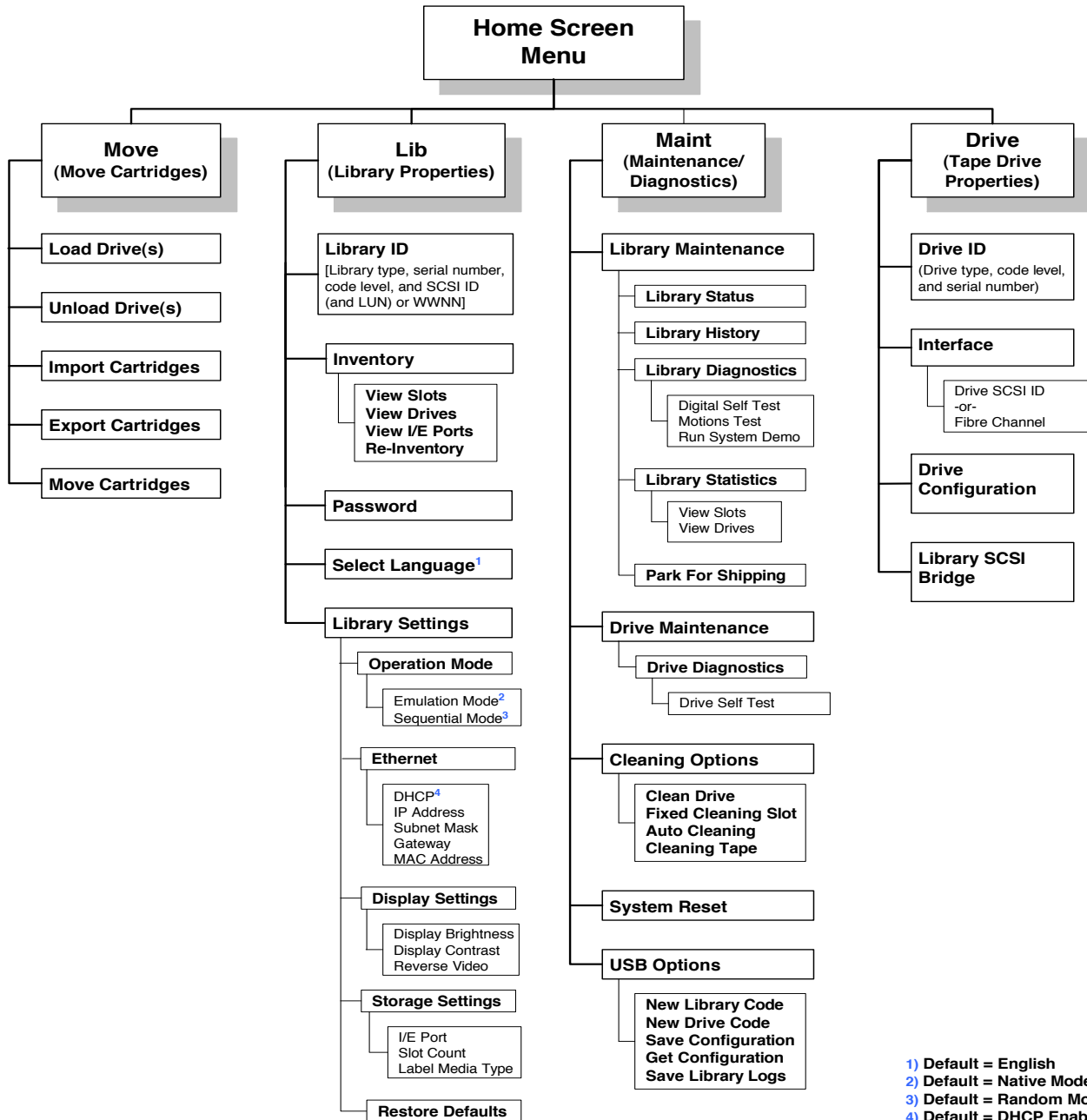

1) Default = English
 2) Default = Native Mode
 3) Default = Random Mode
 4) Default = DHCP Enabled

Troubleshooting Tips

<p>If the library did not power on as described</p>	<ul style="list-style-type: none"> • Is the power cord inserted correctly and is the power switch on (press the I on the back of the unit)? • Did you remove the shipping key?
<p>If the library displays an error on the front panel</p>	<p>Refer to the <i>Product Manual</i> for a list of error messages and corrective actions.</p>
<p>If the Diagnostic tools (LIBTool and LTOTool) are not communicating with the library</p>	<ul style="list-style-type: none"> • Host adapter card installation—Make sure that you installed your host adapter card correctly, that the card is securely seated, and that the appropriate drivers for the adapter are installed. Refer to the documentation that came with your controller for installation instructions. • SCSI ID*—If additional SCSI devices are attached to the same SCSI bus as the library, you may need to change the SCSI IDs of the tape drive(s) in the library.** • Termination*—Make sure the SCSI bus is properly terminated (see step 3).** Make sure the terminator is securely connected. • SCSI connections*—Make sure that all SCSI cables are securely connected. • Fibre Channel connections—Make sure that the GBICs and cables used to connect the tape drives in the library to the Fibre Channel loop are compatible. Make sure that the FC cables are firmly connected to the tape drives and the FC hub or switch. • SCSI controller type*—Make sure that the SCSI controller is an LVD controller. DO NOT connect the tape drive(s) in the library to a single-ended controller, a RAID controller, or an HVD controller. • LVD SCSI devices*—The tape drives in the library are LVD (low-voltage differential) device(s), and all other devices on the SCSI bus must also be LVD (controller card, terminator, and all other devices on the bus).
<p>If your backup software is not communicating with the library</p>	<ul style="list-style-type: none"> • Bus configuration and cables—Refer to the installation instructions (and tips above). Improper bus configuration or bad cables often cause these issues: <ul style="list-style-type: none"> - Devices not being seen in the operating system - Losing communication with a tape drive during backup - Event ID 9 or 11 errors in Windows operating systems - Unexpected bus resets - Intermittent or unexpected “I/O” errors - Parity errors • Software compatibility—Make sure that your library and tape drive are compatible with the backup software you plan to use. Check www.tandbergdata.com. • Control mode—Use Random mode (the default) with an application that controls the library. Use sequential mode only if your backup application will not control the library.** • Tape Drive Configuration—Make sure that the Drive Configuration (Drive/Drive Configuration) matches the tape drive(s) installed.** • Driver installation—Some applications provide their own drivers, some do not, and some require installation of the Tandberg Data provided drivers. Refer to the documentation for your backup application and Tandberg Data Knowledge base item #2003 (www.tandbergdata.com) for more information.
<p>If your library displays a <i>Clean Tape Drive</i> message on the front panel</p>	<p>Use one of the following options to clean the tape drive:</p> <ul style="list-style-type: none"> • Instruct your backup software to issue a Clean the Tape Drive command. Refer to the software documentation and the library <i>Product Manual</i> for instructions. • Use the library's Autoclean option.** • Manually install a cleaning cartridge when the tape drive requires cleaning.**

* All references to SCSI are for the SCSI library only.

** Refer to the Library's Product Manual for instructions or additional information.

Additional Information

Contact Tandberg Data for general information, sales, service and support at:

www.tandbergdata.com

Always check the website for the most up to date information.



IMPORTANT! Before moving or shipping the library, you must first “Park the Robot” and replace the shipping key or you will void your warranty.

- From the library’s front panel, press the Maint / Library Maintenance / Park the Robot buttons.
- After you receive the confirmation message (Park for Shipping Good), insert the shipping key by following the instructions in Step 4 in reverse order. See the *Product Manual* for additional information.

REGISTER YOUR LIBRARY AT:
www.tandbergdata.com

Copyright 2007 Tandberg Data, Exabyte, the Exabyte logo, EZ17, M2, VXA, and VXAtape are registered trademarks; ExaBotics, Mammoth-Tape, and SmartClean are trademarks; SupportSuite is a service mark. Linear Tape-Open, LTO, the LTO Logo, Ultrium and the Ultrium Logo are trademarks of HP, IBM, and Quantum in the US and other countries. All other product names are trademarks or registered trademarks of their respective owners.

P/N 1016989 A

April 2007

