

Under the counter Reverse Osmosis System

INSTALLATION, OPERATION AND MAINTENANCE MANUAL

Warning

Please read carefully before proceeding with installation. Your failure to follow any attached instructions or operating parameters may lead to the product's failure.

Save manual for future reference

MODELS

GTS450 & GTS550

Refer to enclosed warranty for operating parameters to ensure proper use with your water supply.

This manual is used for several variations of the same system. Your system may vary slightly from the pictures or descriptions contained in this manual. It is the end users responsibility to ensure that this system is installed according to all local codes and regulations.

Thank you for your purchase of a state of the art Reverse Osmosis (RO) water treatment system. Water quality concerns are becoming more of a focus for the public. You may have heard about contaminants in the drinking water, such as Arsenic, Chromium, Cryptosporidium or Giardia. There may also be some local water issues such as high levels of Lead and Copper. This water treatment system has been designed and tested to provide you with high quality drinking water for years to come. The following is a brief overview of the system.

Your Reverse Osmosis System:

Osmosis is the process of water passing through a semi permeable membrane in order to balance the concentration of contaminants on each side of the membrane. A semi permeable membrane is a barrier that will pass some particles like clean drinking water, but not other particles like arsenic and lead.

Reverse osmosis uses a semi permeable membrane; however, by applying pressure across the membrane, it concentrates contaminants (like a strainer) on one side of the membrane, producing crystal clear water on the other. This is why RO systems produce both clean drinking water and waste water that is flushed from the system. This reverse osmosis system also utilizes carbon block filtration technology, and can therefore provide a higher quality drinking water than carbon filtration systems alone.

Your system is a four (GTS450) or five (GTS550) stage RO which is based upon separate treatment segments within the one complete water filtration system. These stages are as follows:

5 Stage RO System has 3 vertical bowls. 4 Stage RO System has 2 vertical bowls.

Stage 1 – Sediment filter, recommended change 6 months.

The first stage of your RO system is a five micron sediment filter that traps sediment and other particulate matter like dirt, silt and rust which affect the taste and appearance of your water.

Stage 2 and 3 – Carbon filters, recommended change 6 months - Stage 3 Only on the GTS550 model.

The second and third stages each contain a 5 micron carbon block filter. This helps ensure that chlorine, chloramines and other materials that cause bad taste and odor are greatly reduced.

Stage 4- Membrane, recommended change 2-3 years.

Stage four is the heart of the reverse osmosis system, the RO membrane. This semi permeable membrane will effectively take out TDS & Sodium and a wide range of contaminants such as Perchlorate, Chromium, Arsenic, Copper, Lead as well as Cysts, such as Giardia and Cryptosporidium. Because the process of extracting this high quality drinking water takes time, your RO water treatment system is equipped with a storage tank.

Stage 5- Carbon in-line filter, recommended change 6 - 12 months.

The final stage is an in-line granular activated carbon (GAC) filter. This filter is used after the water storage tank, and is used as a final polishing filter.

Note: Filter & Membrane life may vary based upon local water conditions and/or use patterns.

System Maintenance

Just because you can not taste it, does not mean that it is not there. Contaminants such as Lead, Chromium and Arsenic are undetectable to the taste. Additionally, over time if you do not replace the filter elements, other bad tastes and odors will be apparent in your drinking water. It is important to change out your filters at the recommended intervals as indicated in this system manual. When replacing the filter elements, pay special attention to any cleaning instructions.

With proper installation and maintenance, this system will provide you with high quality water for years to come. All of our water enhancement products are rigorously tested by independent laboratories for safety and reliability.

Table of Contents

Operational Parameters	4
Contents of Reverse Osmosis System.....	4
Tools Recommended For Installation	4
Drill a Hole for the Faucet in a Porcelain Sink.....	5
Punch a Hole for the Faucet in a Stainless Steel Sink	5
Feed Water Valve Installation	5
Feed Water Valve Installation Continued.....	6
How to use Quick Connect Fittings on Your RO System	6
Typical RO Faucet Installation.....	7
Drain Saddle Installation.....	8
System Drain Connection.....	8
Green Tube Connection - Feed Water	9
Yellow Tube Connection - RO Module to Storage Tank	9
Tank Valve Installation (Metal / Plastic Tank).....	9
Reverse Osmosis Module Mounting.....	9
Start up Instructions.....	10
Six Month Maintenance	11
Annual Maintenance	12
Membrane Replacement	13
Optional Flush Valve	14
Check Air Pressure in the Tank	15
Procedure for Extended Non-Use (More than 2 months).....	15
Trouble Shooting	16
Reverse Osmosis System (Diagram / Parts List)	17
Performance Data Sheet.....	18
Arsenic Fact Sheet	19
Service Record	20
Limited Warranty	21

Operational Parameters

Do not use with water that is micro biologically unsafe or of unknown quality without adequate disinfection before or after the system. System is intended to be installed on the cold water line only.

Operating Temperatures:	Maximum 100°F (37.8°C)	Minimum 40°F (4.4°C)
Operating Pressure:	Maximum 100 psi (7.0 kg/cm ²)	Minimum 40 psi (2.80 kg/cm ²)
pH Parameters:	Maximum 11	Minimum 2
Iron:	Maximum 0.2 ppm	
TDS (Total Dissolved Solids)	< 1800 ppm	
Turbidity	< 5 NTU	

Hardness: Recommended hardness not to exceed 10 grains per gallon, or 170ppm. System will operate with hardness over 10 grains but the membrane life may be shortened. Addition of a water softener may lengthen the membrane life.

Water Pressure: The operating water pressure in your home should be tested over a 24 hour period to attain the maximum pressure. If the incoming water pressure is above 100 psi then a water pressure regulator is required. A booster pump is needed for incoming water pressure under 40psi.

Copper Tubing: Reverse Osmosis water should not be run through copper tubing as the purity of the water will leach copper causing an objectional taste in water and pin holes may form in the tubing. Be sure to follow any state or local regulations during installation.

Contents of Reverse Osmosis (RO) System

5 Stage RO System has 3 vertical bowls. 4 Stage RO System has 2 vertical bowls.

- 1 Tank – White (Plastic or Metal)
- 1 Module – White (Filters Pre-Installed)
- 1 Parts Bag
- 1 Faucet Bag
- 1 Manual

Tools Recommended For Installation

- √ 1 1/4" Hole Saw Bit for Faucet opening
- √ Round Knock out Punch for Stainless Sinks 1/2" & 1 1/4"
- √ Adjustable Wrench
- √ Sharp Knife
- √ 1 / 2" & 5/8" Open End Wrenches
- √ Phillips Screw Driver and bit
- √ Needle Nose Pliers – Adjustable Pliers
- √ Electric Drill
- √ 1/8", 1/4" & 3/8" Drill Bits



Drill a Hole for the Faucet in a Porcelain Sink

Note: Most sinks are pre drilled with 1 1/2" or 1 1/4" diameter hole that you can use for your RO faucet. (If you are already using it for a sprayer or soap dispenser, see step 1)

Porcelain sinks are extremely hard and can crack or chip easily. Use extreme caution when drilling.

Step 1 Determine desired location for the RO faucet on your sink and place a piece of masking tape over where the hole is to be drilled. Mark the center of the hole on the tape.

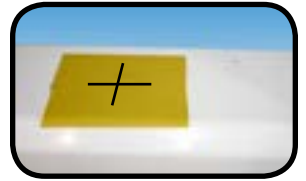

Step 2 Using a variable speed drill set on the slowest speed, drill a 1/8" pilot hole through both porcelain and metal casing of sink at the marked center of the desired location. Use lubricating oil or liquid soap to keep the drill bit cool (If drill bit gets hot it may cause the porcelain to crack or chip).



Step 3 Using a 1 1/4" hole saw, proceed to drill the large hole. Keep drill speed on the slowest speed and use lubricating oil or liquid soap to keep the hole saw cool during cutting.



Step 4 Make sure the surroundings of the sink are cooled before mounting the faucet to the sink after drilling and remove all sharp edges.

Punch a Hole for the Faucet in a Stainless Steel Sink

Note: If mounting faucet to a Stainless Steel Sink you will need a Hole Punch. The faucet opening should be centered between the back splash and the edge of the sink, ideally on the same side as the vertical drain pipe.

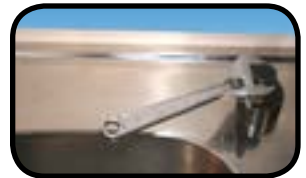

Step 5 Drill a pilot hole & use the Hole Punch and an adjustable wrench to punch the hole in the sink.

Feed Water Valve Installation

Water supply line to the system must be from the cold water supply line only. Hot water will severely damage your system.

Plastic Valve Configuration:



Configuration for 3/8"
(With Brass Fittings)
* Insert White Washer



Hot
Supply

Cold
Supply



Configuration for 1/2"
(Without Brass Fittings)

Feed Water Valve Installation Continued..

Brass Valve Configuration:



Configuration for 3/8" compression fittings



Hot Supply

Cold Supply



Configuration for 1/2" compression fittings

Step 6 Turn off the cold water supply to the faucet by turning the angle stop valve completely off.

Step 7 Attach the adapt-a-valve as illustrated in the three photos above, choosing the configuration that fits your plumbing.

How to use the Quick Connect Fittings on Your RO System

To make a connection, the tube is simply pushed into the fitting. The unique locking system holds the tube firmly in place without deforming it or restricting flow. Use the steps below in reference to any quick connect tube connections throughout this manual.

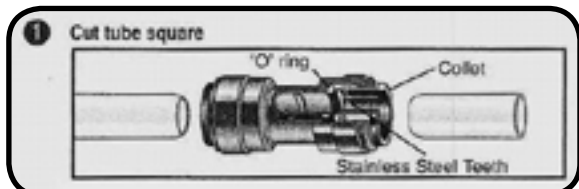

It is essential that the outside diameter be free of score marks and that burrs and sharp edges be removed before inserting into fitting.

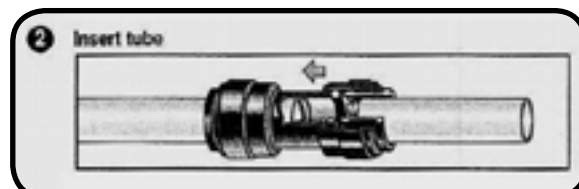

Fitting grips before it seals. Ensure tube is pushed into the tube stop.

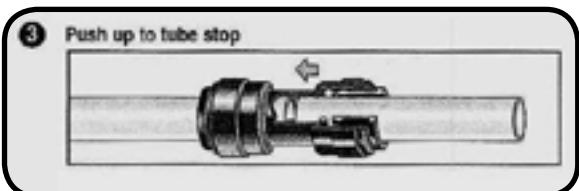

Push the tube into the fitting, to the tube stop. The collet (gripper) has stainless steel teeth which hold the tube firmly in position while the O-ring provides a permanent leak proof seal.

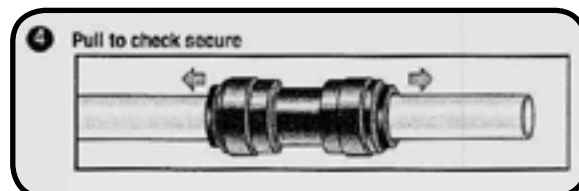

Pull on the tube to check that it is secure. It is a good practice to test the system prior to leaving site and /or before use.

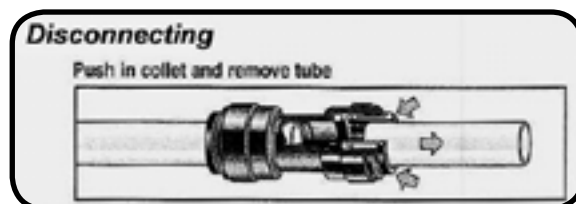

To disconnect, ensure the system is depressurized before removing the tube. Push in the collet squarely against face of fitting. With the collet held in this position, the tube can be removed. The fitting can then be reused.

Typical RO Faucet Installation

Drinking Feed Tube Connection

Non Air Gap Faucet

Locate the 3/8" threaded quick connect fitting in the parts bag. After the faucet has been mounted, thread the fitting on the to faucet stem. Connect the 3/8" blue feed tube to the 3/8" quick connect fitting on the faucet stem. The final polishing filter is clipped on to the top of the RO membrane housing. Attached to the polishing filter is a 3/8" quick connect elbow fitting. Attach the open end of the 3/8" blue tubing from the RO faucet to the 3/8" quick connect elbow on the polishing filter.

With Non Air-Gap faucets this will be the only tube connected to the RO faucet.

Non Air Gap Faucet Installation

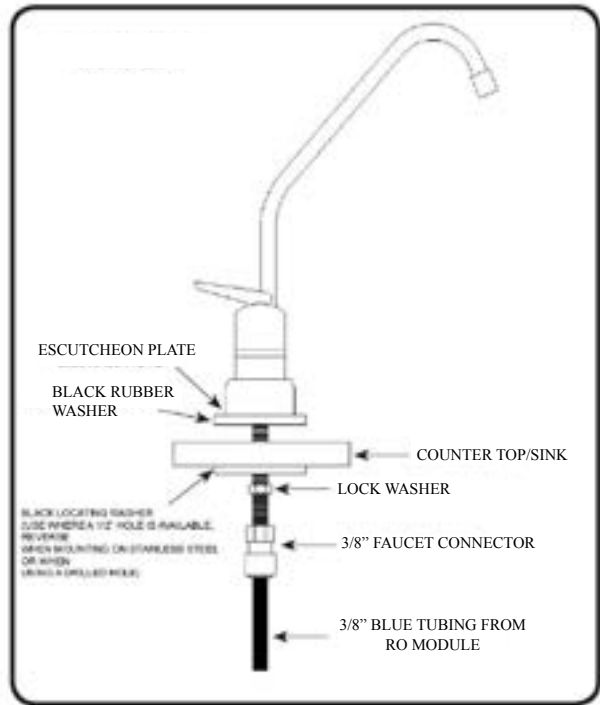

Air Gap Faucet

Follow the drinking feed tube connection instructions above. Installation instructions for the two remaining tubes will be outlined in the upcoming pages.

Air Gap Faucet Installation

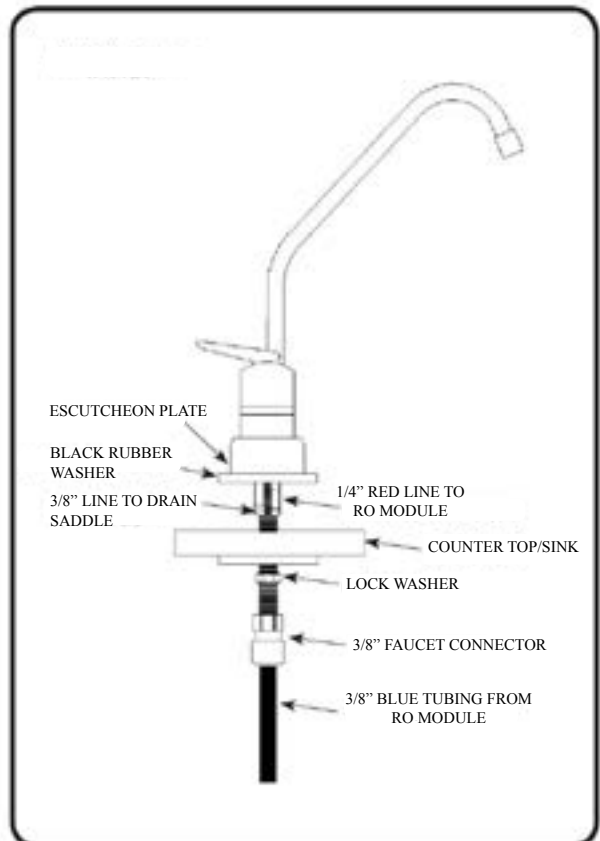

Drain Saddle Installation - Fits standard 1 1/4" – 1 1/2" drain pipes

Caution: *If you have a garbage disposal, do not install the drain saddle near it. Installation of the drain saddle must be either above the garbage disposal, or if a second sink drain is available, install it above the cross bar on the second drain. Installation of the drain saddle near a garbage disposal may cause the drain line to plug.*

If your RO faucet is non-air gap (Single Tube) use 1/4" Drain Saddle.

If your RO faucet is air gap (Three tubes) use the 3/8" Drain Saddle.

Step 8 Locate the drain saddle kit in the parts bag.

Step 9 The small square black foam gasket with a circle cut out of the middle must be applied to the inside of the drain saddle. Remove sticky tape backing and stick to the drain saddle as shown.

Step 10 The drain saddle must be mounted at least 1 1/2" above the nut of the P-trap or cross bar from the garbage disposal to insure proper drainage. Assemble the drain saddle around the drain pipe at the best available location. Using Phillips screw driver tighten screws evenly and securely on both sides of the drain saddle. Keep the plastic compression nut off at this time.

Caution: Do not over tighten the screws. It may crack the drain saddle.

Step 11 With the drain saddle secured onto the drain pipe, using a 1/4" drill bit installed in your electric drill, insert the drill bit through the opening in the drain saddle and drill through the drain pipe.

Caution: It is very important to keep the drill centered to prevent damage of the drain saddle while drilling.

Step 12 * **Non Air-Gap Faucet - Single Tube (1/4" Drain Saddle):**

Slip the 1/4" red tube from the RO module through the black compression nut included in the drain saddle kit. Insert the red tube into the opening in the drain saddle and hand tighten the black nut, and add 1/4 turn with a wrench.

* **Air-Gap Faucet - Three Tubes (3/8" Drain Saddle):**

If your air-gap faucet has no tubes attached, connect the red tube from the RO module directly to the 1/4 barb on the faucet. Locate the black 3/8" tube in the parts bag and attach one end to the 3/8" barb on the faucet.

A/G Faucets with tubes pre-attached - Locate the 1/4"X1/4" quick connect fitting in the parts bag and connect one end to the red tube on the RO module . Measure the 1/4" drain tube feed from the RO faucet to the 1/4"X1/4" fitting on the RO module and make a straight cut to the correct length. Connect the 1/4" drain tube from the RO faucet to the 1/4"X1/4" fitting on the RO module.

All A/G faucets - Measure the 3/8" drain tube from the RO faucet to the drain saddle on the drain pipe and make a straight cut to the correct length. Slip the 3/8" tube open end through the black compression nut. Insert the 3/8" tube into the opening in the drain saddle and hand tighten the black nut, add 1/4 turn with a wrench.

The 3/8" drain tube must be as SHORT and STRAIGHT as possible from the RO faucet to the drain saddle, making a downward slope from faucet to drain saddle to allow for proper drainage. This is a gravity fed line and if there is any bend or dip in the tube, the rinse water will not flow into the drain properly. Water may back up and come out the air gap hole in the back of the faucet.

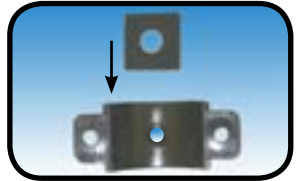

Green Tube Connection - Feed Water

Brass Valve:

Step 13 Connect the green tube to the RO Module open elbow on the left side of the unit. Remove a brass nut, plastic sleeve and brass insert from the parts bag. To assemble, place the brass nut on the green tube first, then the sleeve (small tapered end of sleeve must point to the end of tube) and then push the brass insert all the way into the end of the tube. (See Picture)

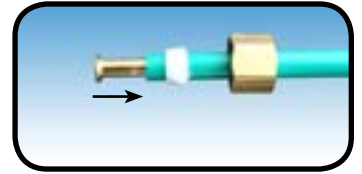

Step 14 Insert the green tube into the 1/4" opening on the adapt-a-valve until it stops. Slide the brass nut and sleeve down and thread onto the male pipe threads. Use a 1/2" wrench to securely tighten the nut.

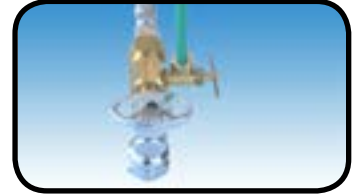

Plastic Valve Valve:

Step 15 Connect the green tube to the RO Module open elbow on the left side of the unit. Insert the open end of the green 1/4" tube into the open 1/4" quick connect fitting on the plastic water feed valve making sure the tube is pushed in all the way to the tube stop.

Yellow Tube Connection - RO Module to Storage Tank

Step 16 Locate the 3/8" Yellow tubing. Connect one open end to the Tee fitting on the final filter that is clipped on to the RO Membrane housing.

Step 17 Position the storage tank in desired location. Stand it upright or lay it on its side (using the black plastic stand). Measure the yellow tube from Tee fitting to TANK and cut it to desired length.

Step 18 Insert the open end Yellow 3/8" tube into the 3/8" opening on the tank ball valve.

Tank Valve Installation - Metal Tank

Step 19 Teflon tape must be applied in a clockwise direction. Wrap 5 to 7 turns around the male pipe threads (MPT) on the Stainless Steel fitting on top of the tank.



Step 20 Thread the plastic valve onto the tank fitting. **Do not over tighten or the valve could crack.**

Tank Valve Installation - Plastic Tank

Step 21 Make sure the O-ring is located at the bottom of the recess for the tank connection.



Step 22 Thread the plastic valve onto the tank fitting. **Do not over tighten or the valve could crack.**

Reverse Osmosis Module Mounting

Step 23 Determine best location for the RO module to be mounted to allow for future system maintenance. The parts bag has 2 self tapping screws. Using an electric drill with a Phillips bit, screw them into the cabinet wall 6" apart and 16" from the bottom of the cabinet.



Congratulations!

You have completed the installation of new your Reverse Osmosis system.

Please Follow the Startup Instructions.

Start up Instructions

Step 1 Turn on the incoming cold water at the angle stop valve. Open the needle valve on the brass Adapt-a-Valve by turning counter clockwise. Check the system for leaks and tighten any fittings as necessary. (Check frequently over the next 24 hours to ensure no leaks are present).

Note: *If you have connected your RO system to a refrigerator / ice maker, make sure the ice maker is off (do not allow water to flow to the ice maker) until flushing (Step 4) is complete and the tank has been allowed to fill completely. Connection from the RO to the ice maker system should have an in-line valve installed before the ice maker so it can easily be closed to prevent water flowing to the ice maker during start up and periodic maintenance. Your RO tank must be allowed to fill up fully in order for the ice maker system to work properly.*

Step 2 Open the RO faucet and leave it open until water begins to trickle out (it will come out slowly).

Step 3 Close the RO faucet allowing the storage tank to fill with water. It may take 3 to 6 hours to fill the tank completely depending on the production capability of the membrane, local water temperature and water pressure.

Note: *During the fill period you may hear water trickling due to the Reverse Osmosis Process.*

Step 4 After the Tank has filled, open the RO Faucet to flush the tank completely. You will know that the tank is empty when the flow rate from the RO faucet is down to a trickle. Repeat this step two more times. The fourth tank can be used for drinking.

The flushing process should take about a day to complete.

Note: *Flushing of the tank 3 times is only necessary during the initial startup and after replacing the membrane.*

6 Month System Maintenance

Items needed:

- √ Stage 1 - Sediment Filter
- √ Stage 2 & 3 - Carbon Block Filter - *Stage 3 Only on the GTS550*

Step 1 Turn off the incoming water supply to the RO by turning the needle valve on the adapt-a-valve clockwise until it stops.

Step 2 Open the RO Faucet and allow water to drain from the tank until it is completely empty.

Note: *Water may be saved in a container for drinking or to rinse system parts.*

Step 3 Let system sit for one minute after the tank is empty to let the system depressurize before attempting to remove filter housings.

Step 4 For more leverage you may leave the RO module attached to wall of cabinet. If you are unable to access the module while it is mounted, remove it prior to changing filters. Starting with the closest housing (Stage 1), remove it by turning it clockwise (left), empty water, then discard filter. Continue on to the 2nd housing (Stage 2) and 3rd housing (Stage 3).

Note: *If you own a four stage system it will not have the third stage. A four stage system has two vertical housings instead of three.*

Step 5 Clean the filter housings (bowls) with a mild soap solution and rinse with water. Check O-rings and lubricate with water soluble lubricant. *KY Jelly® or other water based lubricants may be used. Petroleum based lubricants (such as Vaseline®) must not be used.*

Caution: *Before re-installing the filter bowls back on to the system, check O-rings to make sure they are still in place. **

Step 6 Insert a new sediment filter (cloth like appearance) into the 1st filter housing which is the one on the water inlet side (green tubing from the adapt-a-valve) of the RO system and re-install housing.

Step 7 Insert the new Carbon Block filter (White end caps & plastic netting) into the second and third filter bowls and re-install housings.

Step 8 Turn water supply on to the unit by turning the needle valve on the adapt-a-valve counter clock wise.

Step 9 Open the RO faucet and leave it open until water begins to trickle out (it will come out slowly).

Step 10 Close the RO faucet allowing the storage tank to fill with water. It may take 4 to 6 hours to fill the tank completely depending on the production capability of the membrane, local water temperature and water pressure.



Annual Maintenance

- √ Stage 1 - Sediment Filter
- √ Stage 2 & 3 - Carbon Block Filter - *Stage 3 Only on the GTS550*
- √ Stage 5 - 10" Final Polishing filter
- √ 1/2 Cup of hydrogen peroxide or common household bleach.

Note: *Sanitizing of unit is recommended.*

Step 1 Perform steps 1 through 5 in the Six Month System Maintenance (Page 11).

Note: *If not sanitizing the system skip to step 8.*

Step 2 Remove the RO membrane from its housing and rest in a clean sanitary place. (Refer to "Membrane Replacement" section on page 15 for directions on removing the membrane). Replace cap onto empty membrane housing and re-connect green tubing.

Step 3 Leaving the filters out, replace stage 2 and 3 empty filter housings (hand tight) onto unit. Measure & pour either 1/2 cup of hydrogen peroxide or common household bleach into the 1st filter housing (Stage 1) and hand tighten onto unit.

Step 4 With the RO faucet in the closed position turn on the incoming water supply to the system by turning the adapt-a-valve counter clockwise. Wait 1 minute for the unit to pressurize. Turn on the RO faucet and let the water run for 30 seconds. Turn off the RO faucet and let the unit rest for 2 minutes. Finally, open the RO faucet and let the water run for 5 more minutes.

Step 5 Turn off the incoming water supply to the system by turning the adapt-a-valve clockwise until it stops. Keep the RO faucet open until the storage tank is completely drained.

Step 6 Open the membrane housing and re-install the RO membrane while making sure not to kink the O-rings. (Refer to "Membrane Replacement" section on page 13 for directions on installing the membrane). Tighten the cap back on the housing and reconnect green tubing.

Step 7 Remove filter housings Stage 1, 2 and 3 and empty of water.

Caution: *Before re-installing the filter bowls back on to the system, check O-rings to make sure they are still in place and lubricate with water soluble lubricant.*

Step 8 Insert the new sediment filter (cloth like appearance) into the 1st filter housing which is the one on the water inlet side (green tubing from the adapt-a-valve) of the RO system and re-install housing.

Step 9 Insert the new Carbon Block filter (White End Caps) into the 2nd and 3rd housing and re-install housing.

Step 10 The final in-line filter is located on the blue tube between the storage tank and the RO faucet. Remove it by loosening the compression fittings on both ends of the filter and replace with new filter. (Discard used final filter after sanitizing)

Note: *The arrow on the final filter must be pointing towards the RO faucet / away from the RO storage tank.*

Tip: *This is a good time to check the air pressure in your storage tank. For instructions please see page 14.*

Step 11 Follow Steps 8 through 10 in the Six Month System Maintenance (Page 11) for startup directions.

Membrane Replacement

This reverse osmosis system contains a replaceable component (the RO membrane) which is critical to the efficiency of the system. Replacement of this reverse osmosis membrane should be with one of identical specifications to assure the same efficiency and contaminant reduction performance.

Membranes have a life expectancy between 2 and 5 years, depending on the incoming water conditions and the amount the RO system is used. This reverse osmosis membrane is critical for effective reduction of total dissolved solids (TDS). The product water should be tested periodically to verify that the system is performing satisfactorily.

Normally, a membrane would be replaced during a semiannual or annual filter change. However, if at any time you notice a reduction in water production or an unpleasant taste in the reverse osmosis water, it could be time to replace the membrane. Watts recommends replacing the membrane when TDS reduction falls below 75%.

- Step 1 Turn off the incoming water supply to the RO by turning the needle valve on the adapt-a-valve clockwise until it stops.
- Step 2 Open the RO Faucet and allow water to drain from the tank until it is completely empty.
- Step 3 Remove the polishing filter with clips from the top of the membrane housing.
- Step 4 Disconnect the white tube from the elbow on the end cap of the membrane housing.

Removing the membrane:

- Step 5 Remove the end cap from the membrane housing by turning it counter clockwise to loosen.
- Step 6 You may remove membrane housing from the holding clips. Using a pair of pliers, grip the PVC tube of the RO membrane and pull firmly on the membrane to remove from the housing and discard.

Installing the membrane:

- Step 7 Lubricate the O-rings on the new membrane with a water soluble lubricant such as KY Jelly ®. Insert the end with the two black O-rings on the PVC tube first into the housing.
- Step 8 Once membrane has been inserted into the housing you must take your thumbs and give a firm push to properly seat the membrane. Replace membrane housing cap and tighten.
- Step 9 After replacing membrane housing into the holding clips, re-attach the white tube to the quick connect elbow fitting on the end cap of the membrane housing.
- Step 10 Clip the final polishing filter back on to the membrane housing and follow the Start Up Instructions on page 10.



Models with optional Manual Flush Valve:

Your reverse osmosis unit is equipped with a valve that acts as both a 500ml flow restrictor and a flush valve. The valve comes installed from the factory in the “Closed” flow restrictor setting.

The “closed” position allows the valve to operate as a 500ml flow restrictor which is the normal operating position.

To “flush” the membrane, the valve must be turned so that it is in line with the fitting.

While in the flush position the valve is designed to clean accumulated debris off the membrane by allowing the incoming water to full flow through the membrane to the drain line. Flushing debris from the RO membrane prolongs its lifespan.

A 5 minute manual flush should be completed periodically, about every 1-4 weeks, depending on local water conditions.



Check Air Pressure in the Tank

Important: Check air pressure only when tank is empty of water!

Check air pressure in the storage tank when you notice a decrease in available water from the RO system. Air can be added with a bicycle pump using the schrader valve that is located on the lower side of the tank behind the blue plastic cap.

Step 1 Turn off the incoming water supply to the RO by turning the needle valve on the adapt-a-valve clockwise until it stops. (Follow the green tube away from the RO system to find the adapt-a-valve.)

Step 2 Open the RO Faucet and allow water to drain from the tank until it is completely empty.



Tip: When water from the RO faucet slows to a trickle, with the faucet still in the open position, you may add air to the tank to purge any left over water, this will ensure that the tank is completely empty.

Step 3 Once all water in the tank is purged, check air pressure using an air pressure gauge, it should read between 5 - 7 PSI. (Digital air pressure gauge is recommended)

Step 4 Follow startup procedure on page 10.

Procedure for Extended Non-Use (More than 2 months)

Turn off the water supply by turning the “T” on the adapt-a-valve clockwise until it stops and open the RO faucet to empty the storage tank (Save a few ounces of RO water). Once the storage tank is empty, remove the membrane and place it in a sealed plastic bag with the RO water saved earlier and store in your refrigerator.

For restart, reinstall membrane (See page 13 for membrane installation procedure) and follow startup procedure on page 10.

TROUBLE SHOOTING

Problem	Cause	Solution
1. Low/Slow Production	<p>Low Water Pressure</p> <p>Crimps in tubing Clogged pre-filters Fouled membrane</p>	<p>Assure a minimum of 40 psi incoming water pressure. Watts sells a booster pump if home water pressure is low. Make sure water supply is turned on and Adapta Valve is all the way open.</p> <p>Check tubing and straighten or replace as necessary. Replace pre-filters. Replace membrane and flow restrictor.</p>
2. Milky colored Water	Air in system	Air in the system is a normal occurrence with initial start up of the RO system. This milky look will disappear during normal use within 1-2 weeks. If condition reoccurs after filter change, drain tank 1 to 2 times.
3. Water constantly running, unit will not shut off	<p>Low water pressure</p> <p>Crimp in supply tube High water pressure</p> <p>High pressure in Tank</p> <p>Low Pressure in Tank</p>	<p>See #1 Above</p> <p>Check tubing and straighten or repair as necessary. Check incoming water pressure to make sure it does not exceed 80 psi. A pressure relief valve may be necessary.</p> <p>Empty storage tank of water. Set tank air pressure between 5-7 psi. See previous page.</p> <p>Use a Digital Air Gauge for best results. The empty tank pressure should be 5-7 psi. See page 14.</p>
4. Noise / Water from faucet vent hole or noise from drain.	<p>Crimp or restriction in drain line</p> <p>Drain tube clogged</p>	<p>Check tubing and straighten or repair as necessary. Straighten all drain lines. Clear blockage. Cut off any Excess tubing</p> <p>Caused from dishwasher or garbage disposal. Disconnect the 3/8" black line at the drain, clean the 3/8" black line out with a wire, then reconnect. Blowing air through the line will not always remove the clog.</p>
5. Small amount of water in storage tank	<p>System starting up</p> <p>Low water pressure To much air in tank</p>	<p>Normally it takes 4-6 hours to fill tank. Note: low incoming water pressure and/or temperature can drastically reduce production rate.</p> <p>See #1 above.</p> <p>Tank air pressure should be 5-7 psi when empty of water. If below 5 psi add air or bleed if above 7 psi. Check only when tank is empty of water. See previous page.</p>
6. Water leaks from the blue or white filter housing	<p>Not properly tightened</p> <p>Kinked O-ring</p>	<p>Tighten the bowl.</p> <p>Turn off the water supply and release the pressure. Replace the O-ring if necessary. Then lubricate it and make sure the O-ring is seated in the filter bowl properly before reinstalling the filter bowl.</p>
7. Low water flow from faucet	Check air pressure in tank	Use a Digital Air Gauge for best results. The empty tank pressure should be 5-7 psi. See page 14.

5 Stage Reverse Osmosis System

Compression Fittings

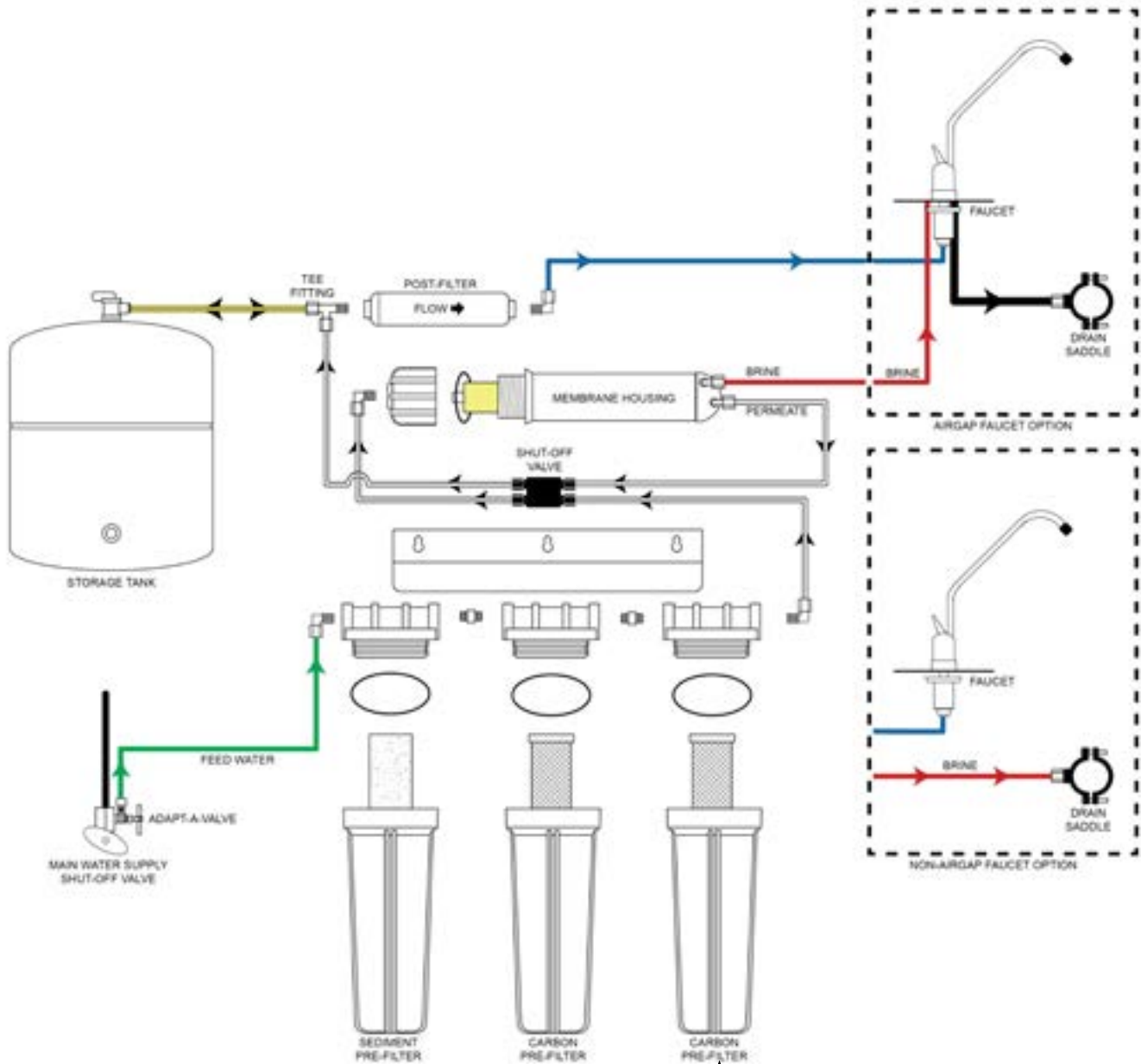

Components

Pre-Filter, sediment	FPMB5-978
Pre-Filter, carbon	WCBCS975
Pre-Filter, carbon	WCBCS975
Membrane	W-1812-50
Post Filter	AICRO
Faucet	FU-WDF-103NSF
Metal Tank	FRO-132-WH
Plastic Tank	ROPRO4-W
Feed water valve	F560080

Third Filter Bowl on
GTS550C System Only

5 Stage Reverse Osmosis System

Quick Connect Fittings

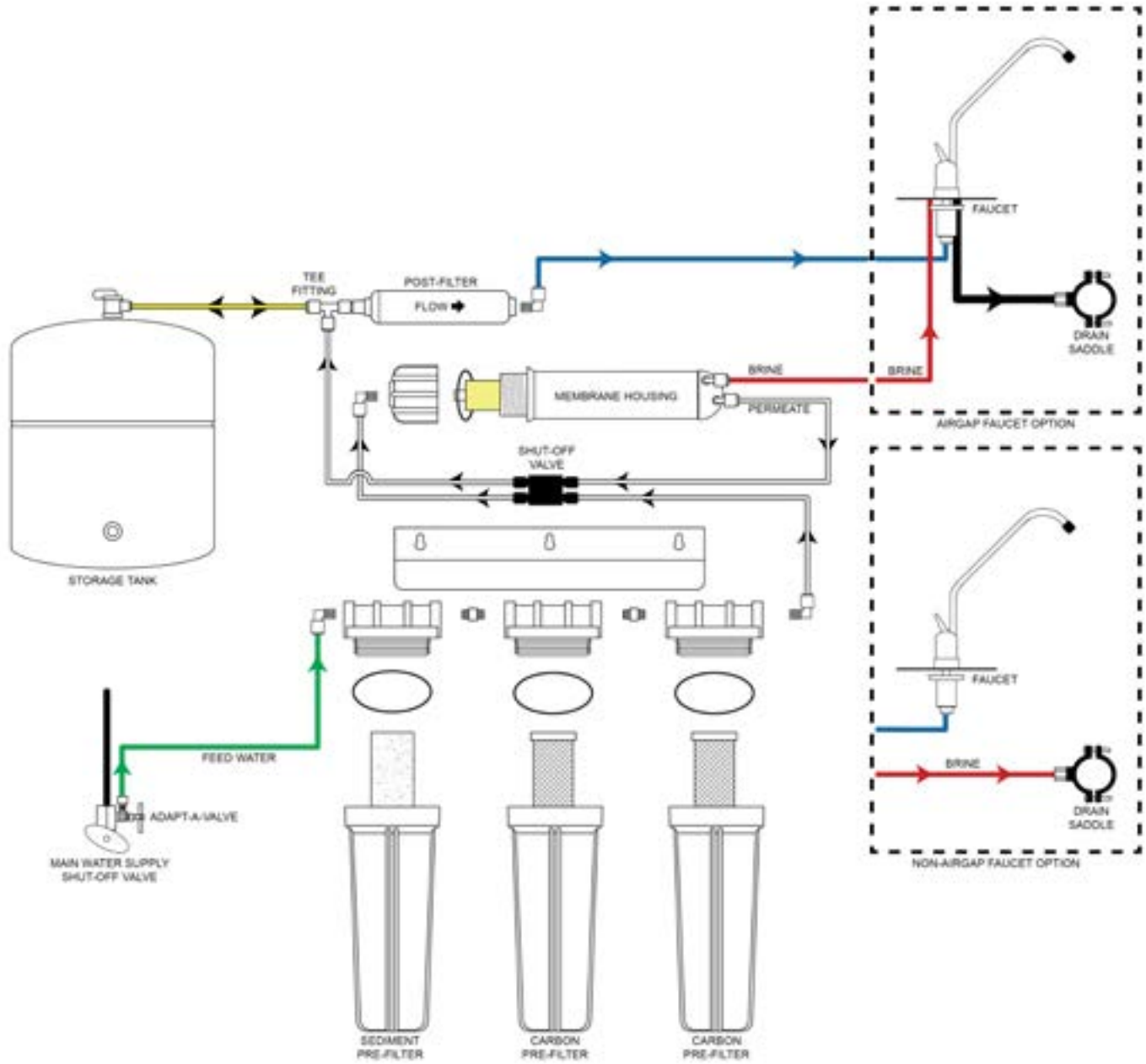

Components

Pre-Filter, sediment	FPMB5-978
Pre-Filter, carbon	WCBCS975
Pre-Filter, carbon	WCBCS975
Membrane	W-1812-50
Post Filter	AICRO
Faucet	FU-WDF-103NSF
Metal Tank	FRO-132-WH
Plastic Tank	ROPRO4-W
Feed water valve	F560080

↑
Third Filter Bowl on
GTS550S System Only

Watts Water Technologies
8716 W Ludlow Drive #1
Peoria, AZ 85381 USA

GTS450 / GTS550

GENERAL USE CONDITIONS:

1. System to be used with municipal or well water sources treated and tested on regular basis to insure bacteriological safe quality. DO NOT use with water that is micro biologically unsafe or unknown quality without adequate disinfection before and after the system. Systems certified for cyst reduction may be used on disinfected water that may contain filterable cysts.
2. Operating Temperature: Maximum: 100°F (40.5°C) Minimum: 40° (4.4°)
3. Operating Water Pressure: Maximum: 100 psi (7.0kg/cm2) Minimum: 40 psi (2.8kg/cm2)
4. pH 2 to 11
5. Maximum iron present in incoming feed water supply must be less than 0.2 ppm.
6. Hardness of more than 10 grains per gallon (170 ppm) may reduce membrane life expectancy.
7. Recommend TDS (Total Dissolved Solids) not to exceed 1800 ppm.

RECOMMENDED REPLACEMENT PARTS AND CHANGE INTERVALS:

Note: Depending on incoming feed water conditions replacement time frame may vary.

Description	Part #	Change time Frame
Sediment Filter, 5 Micron, 9 7/8":	#FPMB5-978	6 Months
Carbon Block, 5 Micron, 9 3/4":	#WCBCS975	6 Months
In-line Carbon Filter:	#AICRO	12 Months
TFC Membrane, 50GPD @60PSI:	#W-1812-50	2 to 5 years

	Avg. In. (mg/L)	Avg. Eff. (mg/L)	% Reduction	pH	Pressure	Max Eff. mg/L	Inf. challenge concentration mg/L	Max Allowable concentration mg/L
Arsenic (Pentavalent)	334.62 ug/L	5.039 ug/L	98.4%		50psi	19 ug/L	0.30±10%	0.010 mg/L
Barium Reduction	10.2	0.13	98.7%	7.24	50psi	0.27	10.0±10%	2.0
Cadmium Reduction	0.031	0.0001	99.7%	7.49	50psi	0.0009	0.03±10%	0005
Chromium (Hexavalent)	0.30	0.006	98.0%	7.24	50psi	0.013	0.03±10%	0.1
Chromium (Trivalent)	0.30	0.003	99.0%	7.24	50psi	0.008	0.03±10%	0.1
Copper Reduction	3.0	0.04	98.7%	7.64	50psi	0.06	3.0±10%	1.3
Cysts	222,077#/ml	10 #/ml	99.99%		50psi	58	minimum 50,000/mL	N/A
Fluoride Reduction	8.0	0.33	95.9%	7.49	50psi	0.47	8.0±10%	1.5
Lead Reduction	0.15	0.004	97.3%	7.49	50psi	0.008	0.15±10%	0.0107
Nitrite and Nitrate	29.2	6.6	77.3%	7.64	50psi	10.0	3.0±10%	10.0
Nitrate Reduction	26.3	6.1	76.8%	7.64	50psi	10.0	3.0±10%	10.0
Nitrite Reduction	2.8	0.5	82.1%	7.64	50psi	0.77	3.0±10%	1.0
Perchlorate	0.10	0.003	96.5%	7.39	50 psi	0.005 mg/L	0.10±10%	0.006
Radium 226/228	25pCi/L	5pCi/L	80.0%	7.24	50psi	5pCi/L	25pCiL±10%	5pCiL
Selenium	0.10	<0.001	99.0%		50psi	<0.001	0.10±10%	0.05
TDS	764	36	95.2%	7.84	50psi	50.0	750±40mg/L	187
Turbidity	81 NTU	0.15 NTU	99.8%		50psi	0.28 NTU	11±1 NTU	0.5 NTU
Recovery - 16.34%			Daily Production Rate - 17.32 GPD				Efficiency - 8.91%	

Depending on water chemistry, water temperature, and water pressure Watts R.O. Systems production and performance will vary. Efficiency rating means the percentage of the influent water to the system that is available to the user as reverse osmosis treated water under operating conditions that approximate typical daily usage. Recovery rating means the percentage of the influent water to the membrane portion of the system that is available to the user as reverse osmosis treated water when the system is operated without a storage tank or when the storage tank is bypassed. There is an average of 4 gallons of reject water for every 1 gallon of product water produced.

REFER TO OWNER'S INSTALLATION/SERVICE MANUAL FOR FURTHER MAINTENANCE REQUIREMENTS AND WARRANTY INFORMATION.

FAX: 210-677-8400

Phone: 800-659-8400

WWW.WATTS.COM

Arsenic Fact Sheet

Arsenic (As) is a naturally occurring contaminant found in many ground waters. Arsenic in water has no color, taste or odor. It must be measured by an arsenic test kit or lab test.

Public water utilities must have their water tested for arsenic. You can obtain the results from your water utility contained within your consumer confidence report. If you have your own well, you will need to have the water evaluated. The local health department or the state environmental health agency can provide a list of test kits or certified labs.

There are two forms of arsenic: pentavalent arsenic (also called As (V), As (+5)) and trivalent arsenic (also called As (III), As (+3)). In well water, arsenic may be pentavalent, trivalent, or a combination of both. Although both forms of arsenic are potentially hazardous to your health, trivalent arsenic is considered more harmful than pentavalent arsenic.

RO systems are very effective at removing pentavalent arsenic. A free chlorine residual will rapidly convert trivalent arsenic to pentavalent arsenic. Other water treatment chemicals such as ozone and potassium permanganate will also change trivalent arsenic to pentavalent arsenic. A combined chlorine residual (also called chloramine) where it does convert trivalent arsenic to pentavalent arsenic, may not convert all the trivalent arsenic in to pentavalent arsenic. If you get your water from a public water utility, contact the utility to find out if free chlorine or combined chlorine is used in the water system.

This Watts reverse osmosis system is designed to remove up to 98% of pentavalent arsenic. It will not convert trivalent arsenic to pentavalent arsenic. Under laboratory standard testing conditions, this system reduced 0.30 mg/L (ppm) pentavalent arsenic to under 0.010 mg/L (ppm) (the USEPA standard for drinking water). Actual performance of the system may vary depending on specific water quality conditions at the consumer's installation.

The RO membrane component of this reverse osmosis system must be maintained according to its recommended maintenance cycle. Specific component identification and ordering information can be found in the installation/operation manual maintenance section.

California Proposition 65 Warning

WARNING: this product contains chemicals known to the State of California to cause cancer and birth defects or other reproductive harm. (Installer: California law requires that this warning be given to the consumer). For more information: www.wattsind.com/prop65.

Service Record

Date of Purchase: _____ Date of Install: _____ Installed by: _____

Date	1st stage Sediment (6 months)	2 nd stage Carbon (6 months)	3rd stage Carbon (6 months) <i>GTS550 Only</i>	Final Filter Carbon (1 year)	TFM Membrane (2-5 years)

NOTES:

Limited Warranty

What your Warranty Covers:

If any part of your Reverse Osmosis System is defective in workmanship (excluding replaceable filters and membranes), return unit after obtaining a return authorization (see below), less tank, within 1 year of original retail purchase, WATTS will repair or, at WATTS option, replace the system at no charge.

How to obtain Warranty Service:

For warranty service, call 800-659-8400 for documentation and a return authorization number. Once the return authorization number has been created, ship your Reverse Osmosis unit (less tank) to our factory, freight and insurance prepaid, with proof of date of original purchase. Include a note stating the problem experienced and include your name, address and your return authorization number. No returns will be accepted with out the proper return authorization number. WATTS will repair it, or replace it, and ship it back to you prepaid.

What this warranty does not cover:

This warranty does not cover defects resulting from improper installation, (contrary to WATTS printed instructions), from abuse, misuse, misapplication, improper maintenance, neglect, alteration, accidents, casualties, fire, flood, freezing, environmental factors, water pressure spikes or other such acts of God.

This warranty will be void if defects occur due to failure to observe the following conditions:

1. The Reverse Osmosis System must be hooked up to a potable municipal or well cold water supply.
2. The hardness of the water should not exceed 10 grains per gallon, or 170 ppm.
3. Maximum incoming iron must be less than 0.2 ppm.
4. The pH of the water must not be lower than 2 or higher than 11.
5. The incoming water pressure must be between 40 and 85 pounds per square inch.
6. Incoming water to the RO cannot exceed 105 degrees F (40 degrees C.)
7. Incoming TDS/Total Dissolved Solids not to exceed 1800 ppm.
8. Do not use with water that is micro biologically unsafe or of unknown quality without adequate disinfection before or after the system.

This warranty does not cover any equipment that is relocated from the site of its original installation.

This warranty does not cover any charges incurred due to professional installation.

This warranty does not cover any equipment that is installed or used outside the United States of America and Canada.

LIMITATIONS AND EXCLUSIONS:

WATTS WILL NOT BE RESPONSIBLE FOR ANY IMPLIED WARRANTIES, INCLUDING THOSE OF MERCHANTABILITY AND FITNESS FOR A PARTICULAR PURPOSE. WATTS WILL NOT BE RESPONSIBLE FOR ANY INCIDENTAL OR CONSEQUENTIAL DAMAGES, INCLUDING TRAVEL EXPENSE, TELEPHONE CHARGES, LOSS OF REVENUE, LOSS OF TIME, INCONVENIENCE, LOSS OF USE OF THE EQUIPMENT, AND DAMAGE CAUSED BY THIS EQUIPMENT AND ITS FAILURE TO FUNCTION PROPERLY. THIS WARRANTY SETS FORTH ALL OF WATTS RESPONSIBILITIES REGARDING THIS EQUIPMENT.

OTHER CONDITIONS:

If WATTS chooses to replace the equipment, WATTS may replace it with reconditioned equipment. Parts used in repairing or replacing the equipment will be warranted for 90 days from the date the equipment is returned to you or for the remainder of the original warranty period, whichever is longer. This warranty is not assignable or transferable.

YOUR RIGHTS UNDER STATE LAW:

Some states do not allow limitations on how long an implied warranty lasts, and some states do not allow the exclusion or limitation of incidental or consequential damages, so the above limitations or exclusions may not apply. This warranty gives you specific legal rights, and you may have other legal rights which vary from state to state.