**Agilent 4396B Network/Spectrum/Impedance
Analyzer**

User's Guide

SERIAL NUMBERS

This manual applies directly to instruments which have the serial number prefix JP1KE.



**Agilent Part No. 04396-90031
Printed in Japan February 2001**

Fourth Edition

Manual Printing History

The manual printing date and part number indicate its current edition. The printing date changes when a new edition is printed. (Minor corrections and updates that are incorporated at reprint do not cause the date to change.) The manual part number changes when extensive technical changes are incorporated.

March 1997 First Edition (part number: 04396-90021)
July 1997 Second Edition (part number: 04396-90031)
March 2000 Third Edition (part number: 04396-90031)
February 2001 Fourth Edition (part number: 04396-90031)

Certification

Agilent Technologies certifies that this product met its published specifications at the time of shipment from the factory. Agilent Technologies further certifies that its calibration measurements are traceable to the United States National Institute of Standards and Technology, to the extent allowed by the Institution's calibration facility, or to the calibration facilities of other International Standards Organization members.

Warranty

This Agilent Technologies instrument product is warranted against defects in material and workmanship for a period of one year from the date of shipment, except that in the case of certain components listed in *General Information* of this manual, the warranty shall be for the specified period. During the warranty period, Agilent Technologies will, at its option, either repair or replace products that prove to be defective.

For warranty service or repair, this product must be returned to a service facility designated by Agilent Technologies. Buyer shall prepay shipping charges to Agilent Technologies and Agilent Technologies shall pay shipping charges to return the product to Buyer. However, Buyer shall pay all shipping charges, duties, and taxes for products returned to Agilent Technologies from another country.

Agilent Technologies warrants that its software and firmware designated by Agilent Technologies for use with an instrument will execute its programming instruction when properly installed on that instrument. Agilent Technologies does not warrant that the operation of the instrument, or software, or firmware will be uninterrupted or error free.

Limitation Of Warranty

The foregoing warranty shall not apply to defects resulting from improper or inadequate maintenance by Buyer, Buyer-supplied software or interfacing, unauthorized modification or misuse, operation outside the environmental specifications for the product, or improper site preparation or maintenance.

No other warranty is expressed or implied. Agilent Technologies specifically disclaims the implied warranties of merchantability and fitness for a particular purpose.

Exclusive Remedies

The remedies provided herein are buyer's sole and exclusive remedies. Agilent Technologies shall not be liable for any direct, indirect, special, incidental, or consequential damages, whether based on contract, tort, or any other legal theory.

Assistance

Product maintenance agreements and other customer assistance agreements are available for Agilent Technologies products.

For any assistance, contact your nearest Agilent Technologies Sales and Service Office. Addresses are provided at the back of this manual.

Safety Summary

The following general safety precautions must be observed during all phases of operation, service, and repair of this instrument. Failure to comply with these precautions or with specific *WARNINGS* elsewhere in this manual may impair the protection provided by the equipment. In addition it violates safety standards of design, manufacture, and intended use of the instrument.

The Agilent Technologies assumes no liability for the customer's failure to comply with these requirements.

Note



4396B comply with INSTALLATION CATEGORY II and POLLUTION DEGREE 2 in IEC1010-1. 4396B are INDOOR USE product.

Note



LEDs in this product are Class 1 in accordance with IEC825-1.
CLASS 1 LED PRODUCT

Ground The Instrument

To avoid electric shock hazard, the instrument chassis and cabinet must be connected to a safety earth ground by the supplied power cable with earth blade.

DO NOT Operate In An Explosive Atmosphere

Do not operate the instrument in the presence of flammable gasses or fumes. Operation of any electrical instrument in such an environment constitutes a definite safety hazard.

Keep Away From Live Circuits

Operating personnel must not remove instrument covers. Component replacement and internal adjustments must be made by qualified maintenance personnel. Do not replace components with the power cable connected. Under certain conditions, dangerous voltages may exist even with the power cable removed. To avoid injuries, always disconnect power and discharge circuits before touching them.

DO NOT Service Or Adjust Alone

Do not attempt internal service or adjustment unless another person, capable of rendering first aid and resuscitation, is present.

DO NOT Substitute Parts Or Modify Instrument

Because of the danger of introducing additional hazards, do not install substitute parts or perform unauthorized modifications to the instrument. Return the instrument to a Agilent Technologies Sales and Service Office for service and repair to ensure that safety features are maintained.

Dangerous Procedure Warnings

Warnings , such as the example below, precede potentially dangerous procedures throughout this manual. Instructions contained in the warnings must be followed.

Warning



Dangerous voltages, capable of causing death, are present in this instrument. Use extreme caution when handling, testing, and adjusting this instrument.

Safety Symbols

General definitions of safety symbols used on equipment or in manuals are listed below.



Instruction manual symbol: the product is marked with this symbol when it is necessary for the user to refer to the instruction manual.



Alternating current.



Direct current.



On (Supply).



Off (Supply).



In position of push-button switch.



Out position of push-button switch.



Frame (or chassis) terminal. A connection to the frame (chassis) of the equipment which normally include all exposed metal structures.

Warning



This **Warning** sign denotes a hazard. It calls attention to a procedure, practice, condition or the like, which, if not correctly performed or adhered to, could result in injury or death to personnel.

Caution



This **Caution** sign denotes a hazard. It calls attention to a procedure, practice, condition or the like, which, if not correctly performed or adhered to, could result in damage to or destruction of part or all of the product.

Note



This **Note** sign denotes important information. It calls attention to a procedure, practice, condition or the like, which is essential to highlight.



Affixed to product containing static sensitive devices use anti-static handling procedures to prevent electrostatic discharge damage to component.

Typeface Conventions

Bold

Boldface type is used when a term is defined. For example: **icons** are symbols.

Italics

Italic type is used for emphasis and for titles of manuals and other publications.

Italic type is also used for keyboard entries when a name or a variable must be typed in place of the words in italics. For example: copy *filename* means to type the word copy, to type a space, and then to type the name of a file such as file1.

Computer

Computer font is used for on-screen prompts and messages.

HARDKEYS

Labeled keys on the instrument front panel are enclosed in □.

SOFTKEYS

Softkeys located to the right of the CRT are enclosed in ▣.

How To Use This Manual

This is a user's guide for the 4396B Network/Spectrum Analyzer. This manual contains two quick start tours, measurement examples, an installation and setup guide and a table that tells you where to find more information.

Installation and Setup Guide

Chapter 1 provides installation information that includes an initial inspection, power line setting, test-set setup, and keyboard connection. If you do not prepare the analyzer yet, read this section first.

Quick Start Tour

Chapters 2 and 3 provide step-by-step instructions for you if you are operating the analyzer for the first time. By performing these tours, you will become familiar with the basic operations of the analyzer. Chapter 2 is for the spectrum analyzer mode, and chapter 3 is for the network analyzer mode.

Measurement Examples

Chapters 4 and 5 provide how to use the analyzer for typical network and spectrum measurement. Chapter 4 contains measurement examples of spectrum measurement applications, and chapter 5 contains examples of network measurement applications.

For More Information

Appendix A provides a table that helps you find the information you need in the documentation set.

Documentation Map

The following manuals are available for the analyzer.

User's Guide (Agilent Part Number 04396-90031)

The User's Guide walks you through system setup and initial power-on, shows how to make basic measurements, explains commonly used features, and typical application measurement examples. After you receive your analyzer, begin with this manual.

Task Reference (Agilent Part Number 04396-90030)

Task Reference helps you to learn how to use the analyzer. This manual provides simple step-by-step instructions without concepts.

Function Reference (Agilent Part Number 04396-90052)

The Function Reference describes all function accessed from the front panel keys and softkeys. It also provides information on options and accessories available, specifications, system performance, and some topics about the analyzer's features.

Programming Guide (Agilent Part Number 04396-90043)

The Programming Guide shows how to write and use BASIC program to control the analyzer and describes how HP Instrument BASIC works with the analyzer..

GPIB Command Reference (Agilent Part Number 04396-90044)

The GPIB Command Reference provides a summary of all available GPIB commands. It also provides information on the status reporting structure and the trigger system (these features conform to the SCPI standard).

Option 010 Operating Handbook (Option 010 only) (Agilent Part Number 04396-90036)

The option 010 Operation Handbook describes the unique impedance measurement functions of the 4396B with option 010.

HP Instrument BASIC Manual Set (Agilent Part Number E2083-90000)

The HP Instrument BASIC User's Handbook introduces you to the HP Instrument BASIC programming language, provide some helpful hints on getting the most use from it, and provide a general programming reference. It is divided into three books, *HP Instrument BASIC Programming Techniques*, *HP Instrument BASIC Interface Techniques*, and *HP Instrument BASIC Language Reference*.



Performance Test Manual (Agilent Part Number 04396-90130)

The Performance Test Manual explains how to verify conformance to published specifications.

Service Manual (Option 0BW only) (Agilent Part Number 04396-90121)

The Service Manual explains how to adjust, troubleshoot, and repair the instrument. This manual is option 0BW only.

Contents

1. Installation and Setup Guide	
Incoming Inspection	1-1
 Replacing Fuse	1-3
Fuse Selection	1-3
Power Requirements	1-4
Power Cable	1-4
Operation Environment	1-6
Ventilation Requirements	1-6
Instruction for Cleaning	1-6
Rack/Handle Installation	1-7
Option 1CN Handle Kit	1-7
Installing the Handle	1-7
Option 1CM Rack Mount Kit	1-8
Mounting the Rack	1-8
Option 1CP Rack Mount & Handle Kit	1-8
Mounting the Handle and Rack	1-8
 Front View	1-9
 Rear View	1-11
Connecting a Test Set for Network Analyzer Mode	1-12
Connecting an Active Probe	1-14
For Spectrum Analyzer Mode	1-14
For Network Analyzer Mode	1-15
Connecting a Keyboard	1-17
Setting Up a 75 Ω Measurement For Spectrum Analyzer Mode	1-18
2. Spectrum Analyzer Tour	
Before You Leave On The Tour	2-1
Overview	2-1
Required Equipment	2-2
Step 1: Preparing for a Measurement	2-3
Turning ON the analyzer	2-3
Connecting the Test Signal Source	2-3
Step 2: Setting Up the Analyzer	2-4
Setting the Active Channel	2-4
Setting the Analyzer Type	2-5
Selecting the Input	2-6
Setting the Frequency Range	2-6
Step 3: Making a Measurement	2-8
Reading the Peak Level Using the Marker	2-8
Setting the Resolution Bandwidth to See Low Level Signals	2-9

Searching for Harmonics Using the Search Function	2-11
Step 4: Saving and Recalling Analyzer Settings	2-12
Preparing the Disk	2-12
Saving Analyzer Settings	2-13
Entering the File Name	2-13
Recalling the Analyzer Settings	2-15
3. Network Analyzer Tour	
Before You Leave On The Tour	3-1
Overview	3-1
Required Equipment	3-2
Step 1: Preparing for the Measurement	3-3
Turning ON the Analyzer	3-3
Connecting the DUT	3-3
Step 2: Setting up the Analyzer	3-5
Setting the Active Channel	3-5
Setting the Analyzer Type	3-6
Selecting the Input	3-7
Setting the Frequency Range	3-8
Performing the Automatic Scaling	3-9
Step 3: Making a Calibration	3-10
Step 4: Reading a Measurement Result	3-12
Reading a Measured Value by Using Marker	3-12
Step 5: Printing Out the Measurement Result	3-14
Configuring and Connecting a Printer	3-14
Making a Hardcopy of the LCD Display	3-14
4. Spectrum Measurement Examples	
Basic Setup	4-1
Harmonic Distortion Measurement	4-2
Test Signal and Test Device	4-2
Measurement Setup	4-2
Connection	4-2
Analyzer Settings	4-3
Multiple Peak Search and Marker List For Harmonic Distortion Measurement	4-3
C/N Measurement	4-4
Test Signal	4-4
Measurement Setup	4-4
Connection	4-4
Analyzer Settings	4-4
Fixed Δ Marker and Noise Format for C/N Measurement	4-4
Tracking a Drifting Signal	4-5
Test Signal	4-5
Measurement Setup	4-5
Connection	4-5
Analyzer Settings	4-5
Tracking an Unstable Signal	4-6
Network Measurement with Spectrum Monitor	4-7
Measurement Setup	4-7
Connection	4-7
Analyzer Settings	4-8
Performing Calibration	4-8
Network Measurement	4-8

Monitoring the Leakage Signal at the B Input Using the Spectrum Monitor	4-9
AM Signal Measurement	4-10
Test Signal	4-10
Measurement Setup	4-10
Connection	4-10
Analyzer Settings	4-10
Carrier Amplitude and Frequency Measurement Using the Marker	4-10
Modulating Frequency and Modulation Index Measurement Using Δ Marker	4-11
FM Signal Measurement	4-12
Test Signal	4-12
Measurement Setup	4-12
Connection	4-12
Analyzer Settings	4-12
Frequency Deviation of Wide Band FM Signal	4-12
Frequency Deviation	4-12
Carrier Level and Modulating Frequency	4-13
Narrow Band FM Signal Measurement	4-14
Burst Signal Measurement	4-16
Test Signal	4-16
Measurement Setup	4-16
Connection	4-16
Analyzer Settings	4-16
Gated Sweep for Burst Signal Measurement	4-17
Zero Span for Time Domain Measurement	4-17

5. Network Measurement Examples

Basic Setup	5-1
Example DUT	5-1
Measuring Transmission Characteristics of a Filter	5-2
Measurement Setup	5-2
Connection	5-2
Analyzer Settings	5-2
Performing Calibration	5-2
Measurement	5-3
Read Out Insertion Loss Using the Marker	5-3
3 dB Bandwidth	5-4
Ripple or Flatness	5-5
Measuring Phase Response	5-6
Using the Expanded Phase Mode	5-7
Measuring Electrical Length	5-8
Measurement Setup	5-8
Measurement	5-8
Electrical Length Adjustment	5-8
Measuring Phase Distortion	5-10
Measurement Setup	5-10
Deviation from Linear Phase	5-10
Group Delay Measurement	5-10
Smoothing Group Delay Trace	5-11
Where to Find More Information	5-11
Reflection Measurement	5-12
Measurement Setup	5-13
Connection	5-13

Analyzer Settings	5-13
Performing Calibration	5-13
Measurement	5-14
Return Loss and Reflection Coefficient	5-14
Standing Wave Ratio	5-15
S-Parameters Measurement	5-16
Data Readout Using the Marker	5-16
Impedance Measurement	5-17
Admittance Measurement	5-18
List Sweep	5-19
Sweep Time Reduction	5-19
Analyzer Settings	5-19
Creating a Sweep List	5-20
Performing List Sweep	5-20
Dynamic Range Enhancement	5-21
Filter Testing Using Limit Lines	5-22
Example of Limit Lines For Filter Testing	5-22
Analyzer Settings	5-22
Creating Limit Lines	5-22
Performing Limit Test	5-23
Separated Limit Lines	5-24
Gain Compression Measurement	5-25
Measurement Setup	5-25
Connection	5-25
Analyzer Settings	5-25
Performance Calibration	5-26
Measurement	5-26
Absolute Output Level Measurement	5-27

A. For More Information

Index

Figures

1-1. Power Cable Supplied	1-5
1-2. Rack Mount Kits Installation	1-7
1-3. Connecting a Transmission/Reflection Test Set	1-12
1-4. Connecting an S-parameter Test Set	1-13
1-5. Spectrum Analyzer Mode (One Active Probe)	1-14
1-6. Network Analyzer Mode (One Active Probe)	1-15
1-7. Network Analyzer Mode (Two Active Probes)	1-16
1-8. Using a Transmission/Reflection Test Set	1-17
1-9. Connecting a Keyboard	1-18
2-1. Required Equipment	2-2
3-1. Required Equipment	3-2
3-2. Transmission/Reflection Test Set Setup	3-3
3-3. S-Parameter Test Set Setup	3-4
4-1. Basic Connection for Spectrum Measurement	4-1
4-2. Harmonics Measurement Setup	4-2
4-3. Using Multiple Peak Search and Marker List to Measure Harmonic Distortion	4-3
4-4. Using Markers and Noise Format to Measure C/N Ratio	4-4
4-5. Display When Starting Signal Track	4-6
4-6. Display After Signal Has Drifted	4-6
4-7. Influence on Network Measurement by Leakage from an Adjacent Circuit	4-7
4-8. Network Measurement With Spectrum Monitor Setup	4-7
4-9. Transmission Measurement Result (Influenced by Leakage)	4-8
4-10. Spectrum Monitoring Result at the B Input	4-9
4-11. Dual Display of Network and Spectrum Measurement	4-9
4-12. Carrier Amplitude and Frequency of AM Signal	4-11
4-13. Modulating Frequency of AM Signal	4-11
4-14. Wide Band FM Signal Measurement	4-13
4-15. Zooming Carrier Signal of FM Signal	4-14
4-16. Narrow Band FM Signal Measurement	4-14
4-17. Maximum and Minimum Envelopes of Narrow Band FM Signal	4-15
4-18. Superimposing Spectrum and Envelopes	4-15
4-19. Burst Signal Measurement Setup	4-16
4-20. Burst Signal Measurement Result Using Normal Sweep	4-17
4-21. Burst Signal Measurement Using Gated Sweep	4-17
4-22. Burst Signal Spectrum and Test Signal Envelope	4-18
5-1. Transmission Measurement Setup	5-2
5-2. Response of a Dielectric Filter	5-3
5-3. Using the Marker to Determine 3 dB Bandwidth	5-4
5-4. Using Peak Search to Determine Ripple	5-5
5-5. Amplitude and Phase Response of a Dielectric Filter	5-6
5-6. Expanded Phase Mode	5-7

5-7. Phase Response of a Dielectric Filter Over a 50 MHz Span	5-8
5-8. Electrical Length Adjustment	5-9
5-9. Deviation From Linear Phase	5-10
5-10. Group Delay	5-11
5-11. Reflection Measurement	5-12
5-12. Reflection Measurement Setup	5-13
5-13. Return Loss	5-14
5-14. SWR	5-15
5-15. S_{11} on Polar Chart	5-16
5-16. Impedance Measurement	5-17
5-17. Admittance Measurement	5-18
5-18. Sweep List Edit Display	5-20
5-19. Dynamic Range Enhancement	5-21
5-20. Editing the Limit Lines	5-23
5-21. Separated Limit Lines	5-24
5-22. Gain Compression Measurement Setup	5-25
5-23. Gain Compression	5-26
5-24. Input vs. Output Power Level at the -1 dB Gain Compression Point	5-27

Tables

1-1. Contents	1-2
1-2. Fuse Selection	1-3
1-3. Rack Mount Kits	1-7

Installation and Setup Guide

This chapter provides installation and setup instructions. It contains the following information:

- Incoming Inspection
- Replacing Fuse
- Power Requirements
- Operation Environment
- Ventilation Requirements
- Instruction for Cleaning
- Rack/Handle Installation
- Connecting a Test Set for Network Analyzer Mode
- Connecting an Active Probe
- Connecting a Keyboard
- Setting Up a 75 Ω Measurement For Spectrum Analyzer Mode

Incoming Inspection

Warning



To avoid hazardous electrical shock, do not turn on the 4396B when there are signs of shipping damage to any portion of the outer enclosure (for example, covers, panel, or display)

Inspect the shipping container for damage. If the shipping container or cushioning material is damaged, it should be kept until the contents of the shipment have been checked for completeness and the 4396B has been checked mechanically and electrically. The contents of the shipment should be as listed in Table 1-1. If the contents are incomplete, if there is mechanical damage or defect, or if the analyzer does not pass the power-on selftests, notify the nearest Agilent Technologies office. If the shipping container is damaged, or the cushioning material shows signs of unusual stress, notify the carrier as well as the Agilent Technologies office. Keep the shipping materials for the carrier's inspection.

Table 1-1. Contents

Description	Agilent Part Number
Network/Spectrum/Impedance Analyzer	4396B
Documents	
Task Reference	04396-90030
User's Guide	04396-90031
Function Reference	04396-90052
Programming Guide	04396-90043
GPIB Command Reference	04396-90044
Performance Test Manual	04396-90130
N to BNC adapter (50 Ω)	1250-0780
BNC cable	8120-1839
Sample Program Disk (2 disks)	04396-61002
3.5inch 2HD Disk (blank)	9164-0299
mini-DIN Keyboard	C3757-60401
Power Cable ¹	-
Option 0BW only	
Service Manual	04396-90121
Option 1D5 only	
BNC Adapter	1250-1859
Option 1D7 only	
50 Ω /75 Ω Minimum Loss Pad	11852B option 004
50 Ω BNC-75 Ω N Adapter	1250-2438
Option 1CN Handle Kit	
Handle Kit	5062-3991
Option 1CM Handle Kit	
Rack Mount Kit	5062-3979
Option 1CP Rack Mount & Handle Kit	
Rack Mount & Handle Kit	5062-3985

¹ The power cable depends on where the instrument is used, see Figure 1-1.

Replacing Fuse

Fuse Selection Select proper fuse according to the Table 1-2.

Table 1-2. Fuse Selection

Fuse Rating/Type	Fuse Part Number
5A 250Vac UL/CSA type Time Delay	2110-0030

For ordering the fuse, contact your nearest Agilent Technologies Sales and Service Office.

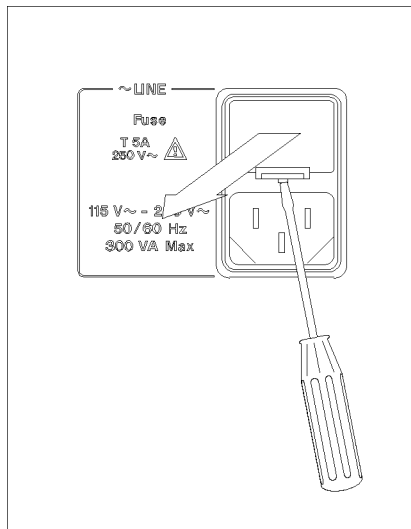

Lever a small minus screwdriver to dismount the fuse holder above the AC line receptacle on the rear panel.

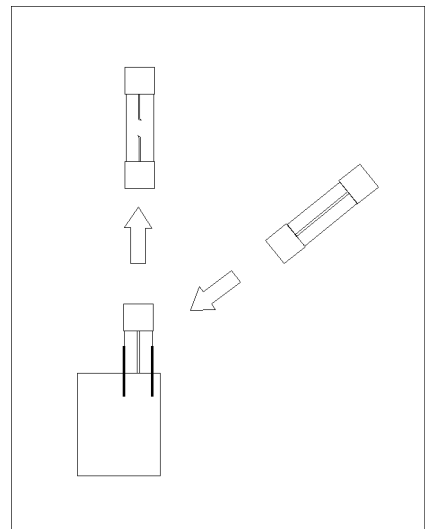

To check or replace the fuse, pull the fuse holder and remove the fuse. To reinstall the fuse, insert a fuse with the proper rating into the fuse holder.

Power Requirements

The 4396B requires the following power source:

Voltage : 90 to 132 Vac, 198 to 264 Vac

Frequency : 47 to 63 Hz

Power : 300 VA maximum

Power Cable

In accordance with international safety standards, this instrument is equipped with a three-wire power cable. When connected to an appropriate ac power outlet, this cable grounds the instrument frame.

The type of power cable shipped with each instrument depends on the country of destination. Refer to Figure 1-1 for the part numbers of the power cables available.

Warning



For protection from electrical shock, the power cable ground must not be defeated.

The power plug must be plugged into an outlet that provides a protective earth ground connection.

<p>OPTION 900</p>  <p>Plug : BS 1363A, 250V Cable : 8120-1351</p>	<p>OPTION 901</p>  <p>Plug : NZSS 198/AS C112, 250V Cable : 8120-1369</p>
<p>OPTION 902</p>  <p>Plug : CEE-VII, 250V Cable : 8120-1689</p>	<p>OPTION 903</p>  <p>Plug : NEMA 5-15P, 125V, 15A Cable : 8120-1378</p>
<p>OPTION 904</p>  <p>Plug : NEMA 6-15P, 250V, 15A Cable : 8120-0698</p>	<p>OPTION 906</p>  <p>Plug : SEV 1011.1959-24507 Type 12, 250V Cable : 8120-2104</p>
<p>OPTION 912</p>  <p>Plug : DHCR 107, 220V Cable : 8120-2956</p>	<p>OPTION 917</p>  <p>Plug : SABS 164, 250V Cable : 8120-4211</p>
<p>OPTION 918</p>  <p>Plug : JIS C 8303, 125V, 15A Cable : 8120-4753</p>	<p>OPTION 922</p>  <p>Plug : GB 1002, 250V Cable : 8120-8376</p>
<p>NOTE: Each option number includes a 'family' of cords and connectors of various materials and plug body configurations (straight, 90° etc).</p>	

Figure 1-1. Power Cable Supplied

Operation Environment

The 4396B must be operated under within the following environment conditions, and sufficient space must be kept behind the 4396B to avoid obstructing the air flow of the cooling fans.

Temperature: 0°C to 40°C

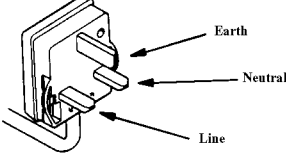
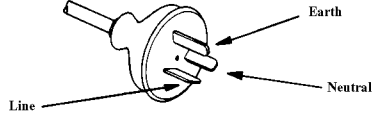
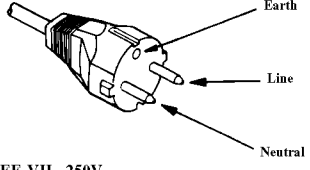
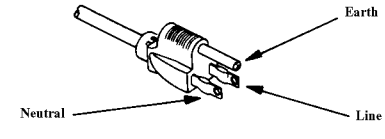
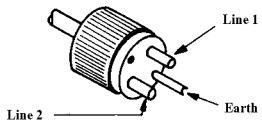
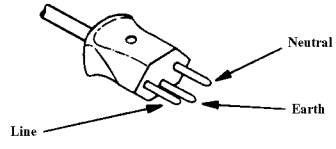
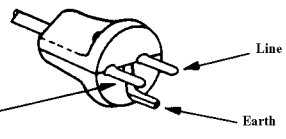
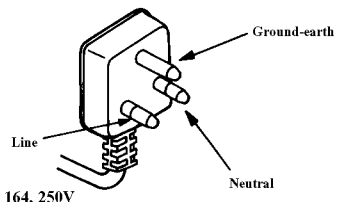
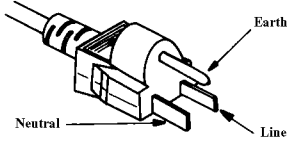
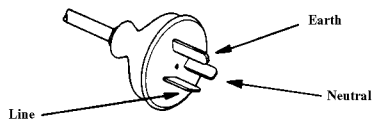
Humidity: less than 95% RH at 40°C

Note



The 4396B must be protected from temperature extremes which could cause condensation within the instrument.

Ventilation Requirements

To ensure adequate ventilation, make sure that there is adequate clearance of at least 180mm behind and 60mm sides.

Instruction for Cleaning

To prevent electrical shock, disconnect the 4396B power cable from the receptacle before cleaning. Wipe with a dry cloth or a soft cloth that is soaked with water and wrung tightly without undue pressure to clean the casing. Do not attempt to clean the 4396B internally.

Rack/Handle Installation

The analyzer can be rack mounted and used as a component in a measurement system. Figure 1-2 shows how to rack mount the analyzer.

Table 1-3. Rack Mount Kits

Option	Description	Agilent Part Number
1CN	Handle Kit	5062-3991
1CM	Rack Mount Kit	5062-3979
1CP	Rack Mount & Handle Kit	5062-3985

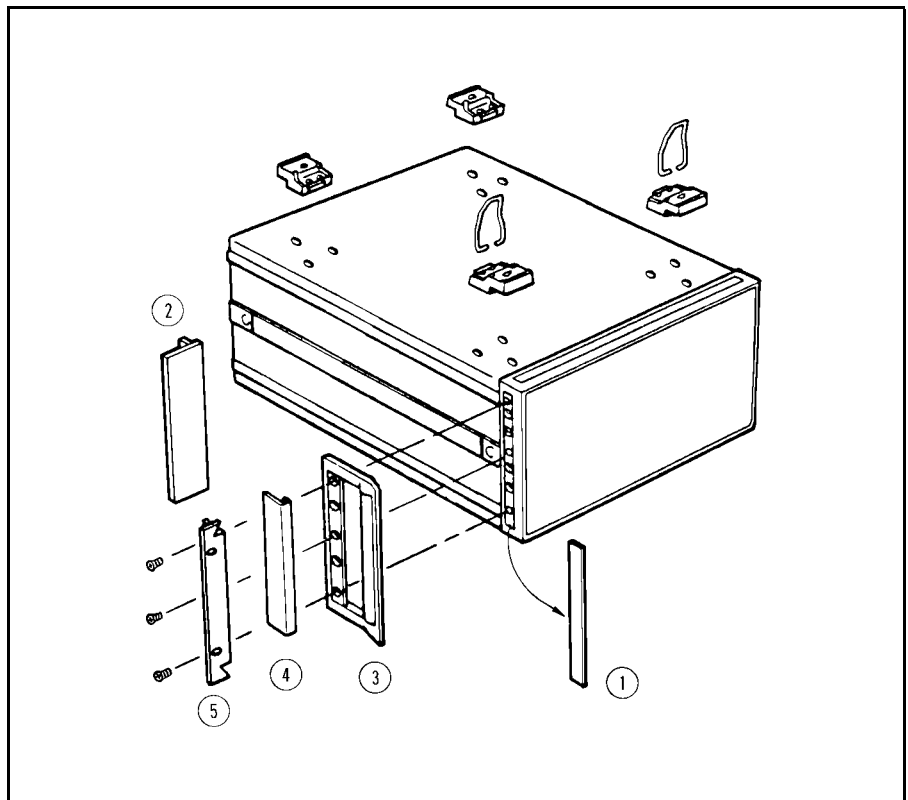

Figure 1-2. Rack Mount Kits Installation

Option 1CN Handle Kit

Option 1CN is a handle kit containing a pair of handles and the necessary hardware to attach them to the instrument.

Installing the Handle

1. Remove the adhesive-backed trim strips ① from the left and right front sides of the analyzer.
2. Attach the front handles ③ to the sides using the screws provided.
3. Attach the trim strips ④ to the handles.

Option 1CM Rack Mount Kit

Option 1CM is a rack mount kit containing a pair of flanges and the necessary hardware to mount them to the instrument in an equipment rack with 482.6 mm (19 inches) horizontal spacing.

Mounting the Rack

1. Remove the adhesive-backed trim strips ① from the left and right front sides of the analyzer.
2. Attach the rack mount flange ② to the left and right front sides of the analyzer using the screws provided.
3. Remove all four feet (lift bar on the inner side of the foot, and slide the foot toward the bar).

Option 1CP Rack Mount & Handle Kit

Option 1CP is a rack mount kit containing a pair of flanges and the necessary hardware to mount them to an instrument which has handles attached, in an equipment rack with 482.6 mm (19 inches) spacing.

Mounting the Handle and Rack

1. Remove the adhesive-backed trim strips ① from the left and right front sides of the analyzer.
2. Attach the front handle ③ and the rack mount flange ⑤ together on the left and right front sides of the analyzer using the screws provided.
3. Remove all four feet (lift bar on the inner side of the foot, and slide the foot toward the bar).

Front View

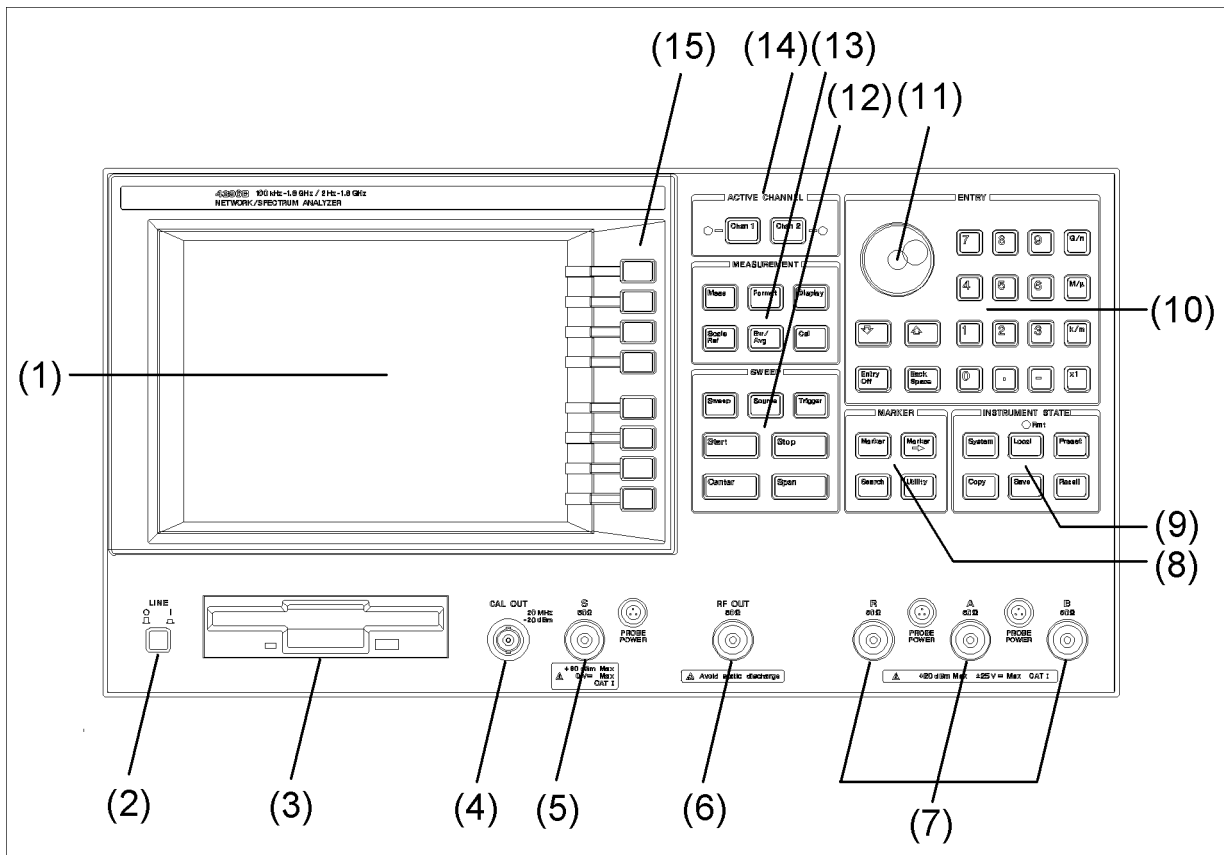

Cb101001

1. **LCD** displays measured results, softkey menus, current settings, system messages, error messages, and Instrument BASIC programs.
2. **LINE** switch turns the analyzer ON and OFF.
3. **3.5 inch disk drive** is used to store measurement results, instrument settings, display images, and Instrument BASIC programs.
4. **CAL OUT (spectrum analyzer calibration output port)** supplies a reference signal (20 MHz, -20 dBm) for reference level calibration.
5.  **S input (spectrum analyzer input)** receives a signal for a spectrum measurement.

INSTALLATION CATEGORY I

6. **RF OUT (RF signal output port)** supplies a source signal for network measurements.

7.  **R, A, and B inputs (RF signal inputs)** mainly accept signals for network measurements, but can also be used as spectrum measurement inputs.

INSTALLATION CATEGORY I

8. **MARKER block** contains keys related to the marker functions.
9. **INSTRUMENT STATE block** contains keys related to setting analyzer functions.
10. **ENTRY block** contains numerical keys, rotary knob, increment/decrement keys, edit keys, and unit-terminator keys.
11. **Rotary knob** changes displayed value by turning the knob.
12. **SWEEP block** contains keys related to the sweep functions.
13. **MEASUREMENT block** controls the measurement and display functions.
14. **ACTIVE CHANNEL block** selects the active channel as 1 or 2.
15. **Softkeys** used with hierarchical menus that are displayed by pressing hardkeys. Pressing a softkey activates the displayed function or accesses a lower level menu.

Rear View

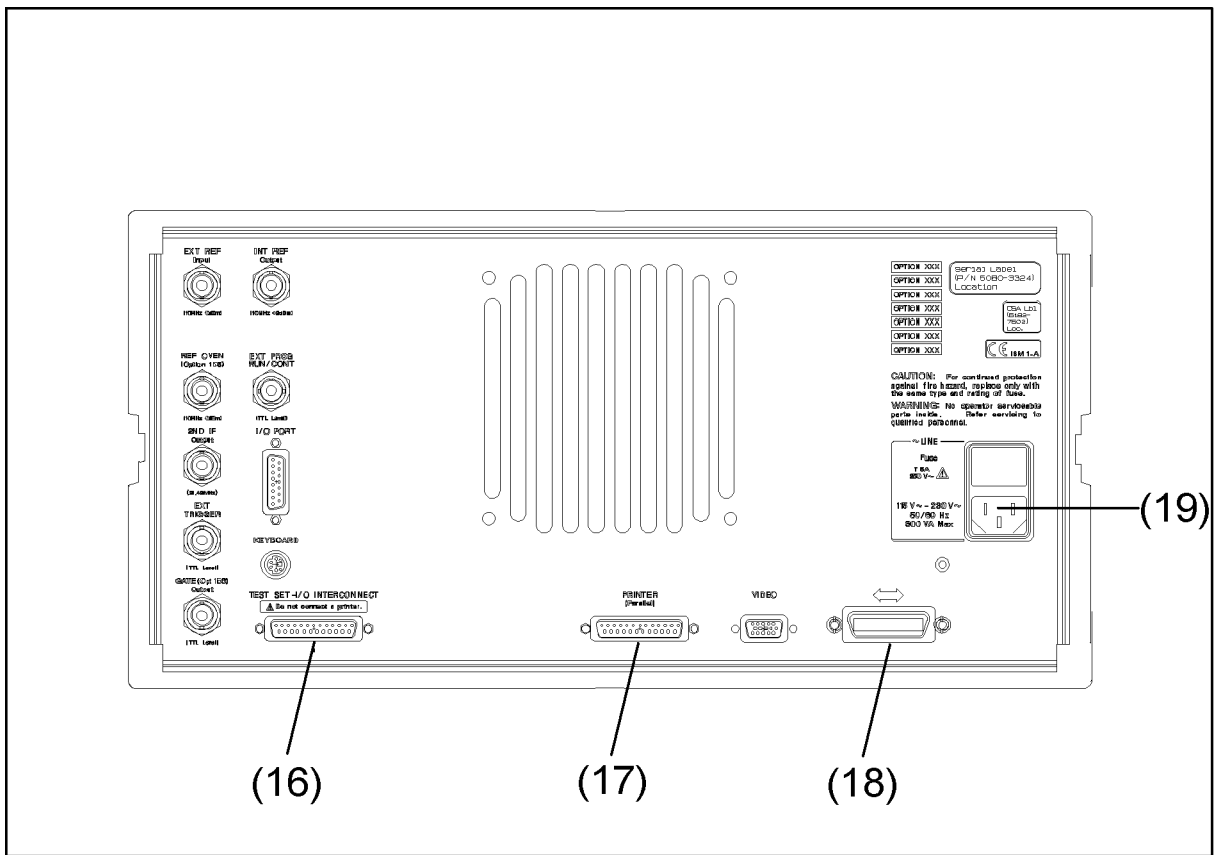

CB101002

16.  **TEST SET-I/O INTERCONNECT** connects the S-parameter test set to the analyzer.

Caution



If you connect a printer with the TEST SET-I/O INTERCONNECT, it may cause damage to the printer. Do not connect a printer to this connector.

17. **Parallel interface** connects the printer to the analyzer.
18. **GPIB interface** controls an GPIB instrument or can be controlled by an external controller.
19. **Power cable receptacle** connects the power cable. Fuse is held in the cover of the receptacle.

Connecting a Test Set for Network Analyzer Mode

To use the network analyzer mode of the analyzer, a test set is required to measure the transmission and reflection characteristics of the device under test (DUT).

You can use either the 87512A/B transmission/reflection (T/R) test set or the 85046A/B S-parameter test set. The 87512A/B T/R test set measures reflection and transmission in the forward direction only. The 85064A/B S-parameter test set measures both the forward and reverse directions without reconnection.

For more information about the test sets, see chapter 9 of the *Function Reference* manual.

Connecting a Transmission/Reflection Test Set

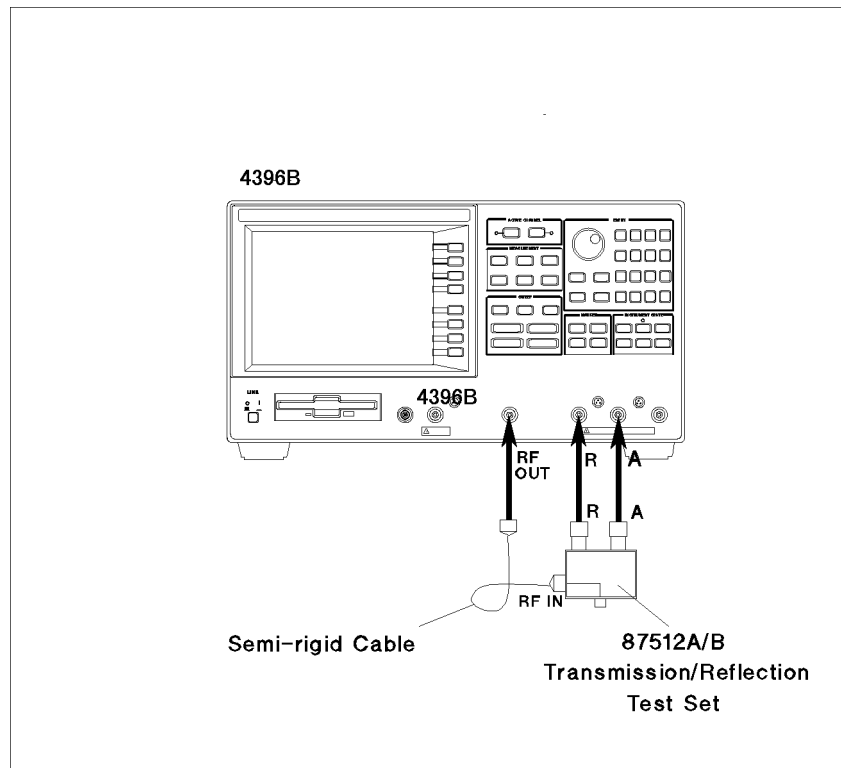

Figure 1-3. Connecting a Transmission/Reflection Test Set

1. Place the transmission/reflection (T/R) test set in front of the analyzer.
2. Connect the R and A ports of the analyzer and the T/R test set to each other.
3. Connect the RF OUT port of the analyzer and the RF IN port of the T/R test set with a semi-rigid cable.

Note

When you use the 87512B, press **[Ca]** **MORE SET Z0**. Then press **[7]** **[5]** **[X1]** to set the characteristic impedance (Z_0) to 75 Ω .

Connecting an S-parameter Test Set

Figure 1-4. Connecting an S-parameter Test Set

1. Place the analyzer on the S-parameter test set.
2. Connect the TEST SET-I/O INTERCONNECT interface on the rear panel of the analyzer and the NETWORK ANALYZER-I/O INTERCONNECT interface of the test set using the cable furnished with the test set.
3. Connect the RF OUT, R, A, and B inputs of the analyzer to the S-parameter test set to each other.

Note

When you use the 85064B, press **[Ca]** **MORE SET Z0**. Then press **[7]** **[5]** **[X1]** to set the characteristic impedance (Z_0) to 75 Ω .

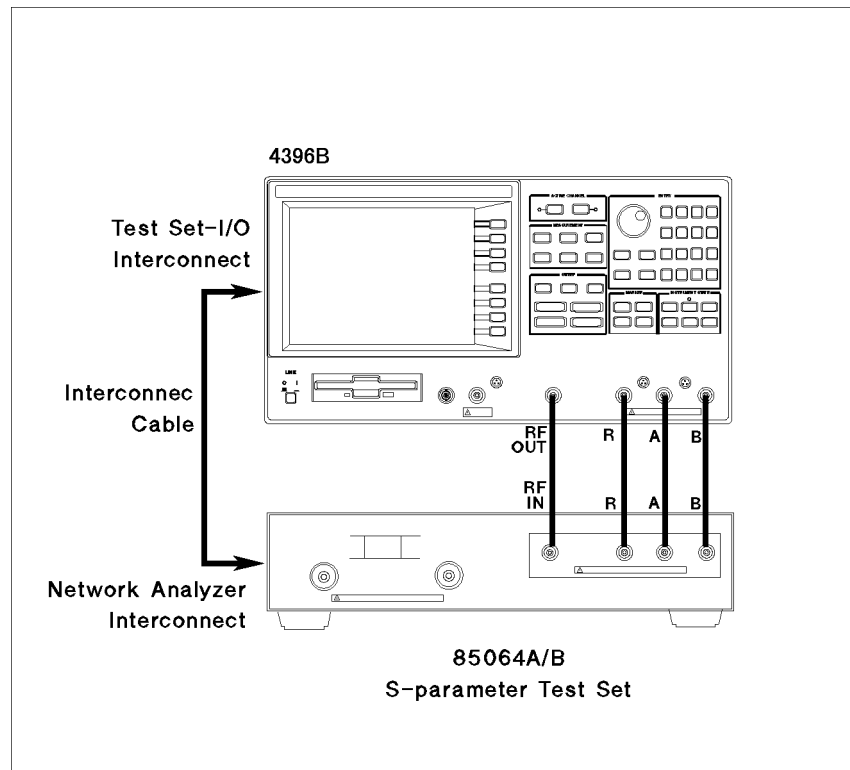
Connecting an Active Probe

The active probe allows you to analyze an in-circuit signal or device that has no port for connecting to the test set. The active probe can be used for both spectrum and network measurements.

The analyzer can use the following active probes:

- 85024A High Frequency Probe (300 kHz to 3 GHz)
- 41800A Active Probe (5 Hz to 500 MHz)
- 41802A 1 M Ω Input Adapter (5 Hz to 100 MHz)
- 51701A Active Probe (DC to 2.5 GHz)
- 11945A Close-field Probe Set
- 1141A Differential Probe

For more information about these active probes, see chapter 9 of the *Function Reference* manual.

For Spectrum Analyzer Mode

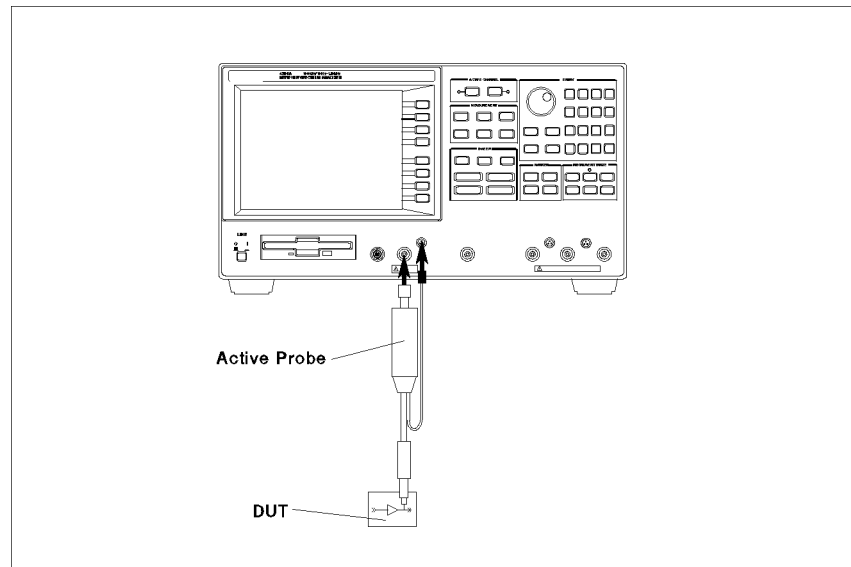

C610A012

Figure 1-5. Spectrum Analyzer Mode (One Active Probe)

1. Connect the output connector of the active probe to the S port of the analyzer.
2. Plug the probe power plug into the PROBE POWER connector.

For Network Analyzer Mode

Using One Active Probe

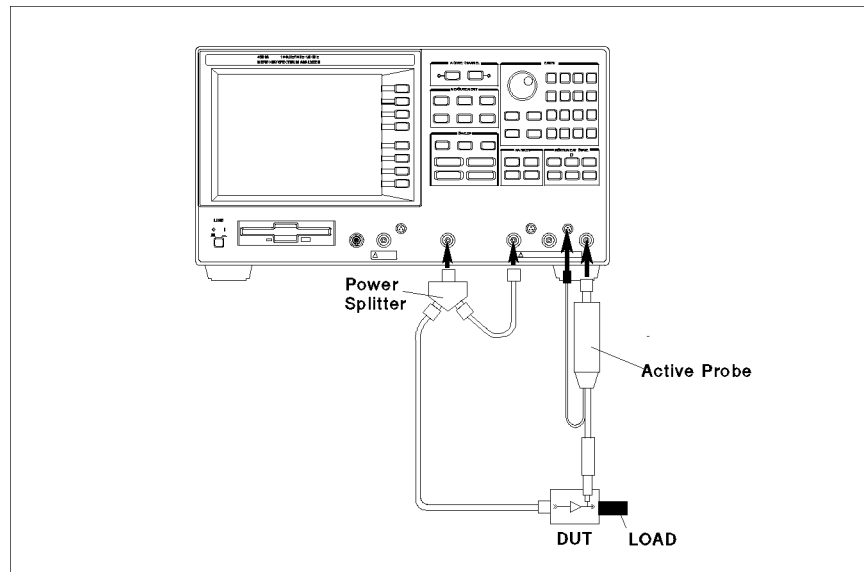

Figure 1-6. Network Analyzer Mode (One Active Probe)

1. Connect the power splitter to the RF OUT port.
2. Connect one output from the power splitter to the R input.
3. Connect the other output of the power splitter to the DUT.
4. Connect the active probe to the B input and plug the probe plug into the PROBE POWER connector.
5. If necessary, terminate the DUT with a load.

Note



The following power splitters are available for the analyzer:

- 11850C,D Three-way Power Splitter
- 11667A Power Splitter

For more information about these power splitters, see chapter 9 of the *Funtion Reference* manual.

Using Two Active Probes

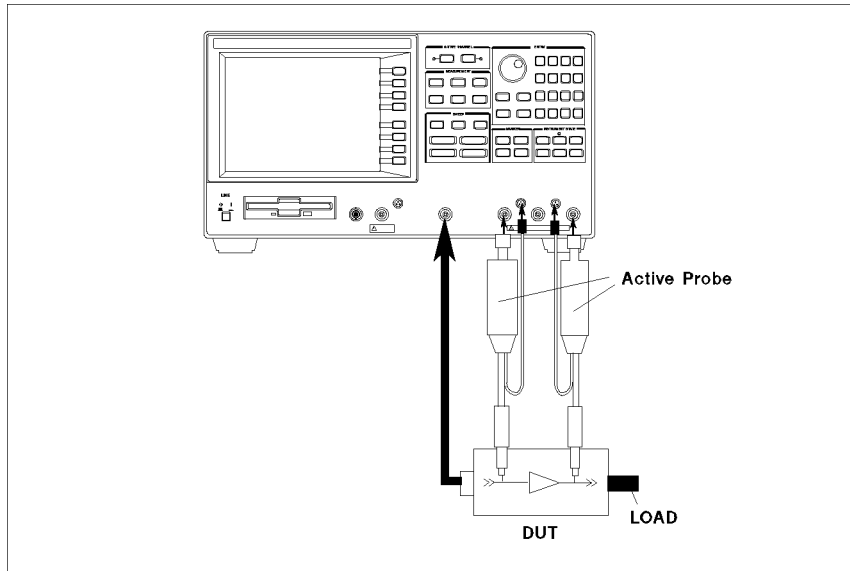

C510A015

Figure 1-7. Network Analyzer Mode (Two Active Probes)

1. Connect one active probe to the R input.
2. Connect the other active probe to the B input.
3. Connect the RF OUT port to the DUT.
4. If necessary, terminate the DUT with a load.

Using a Transmission/Reflection Test Set

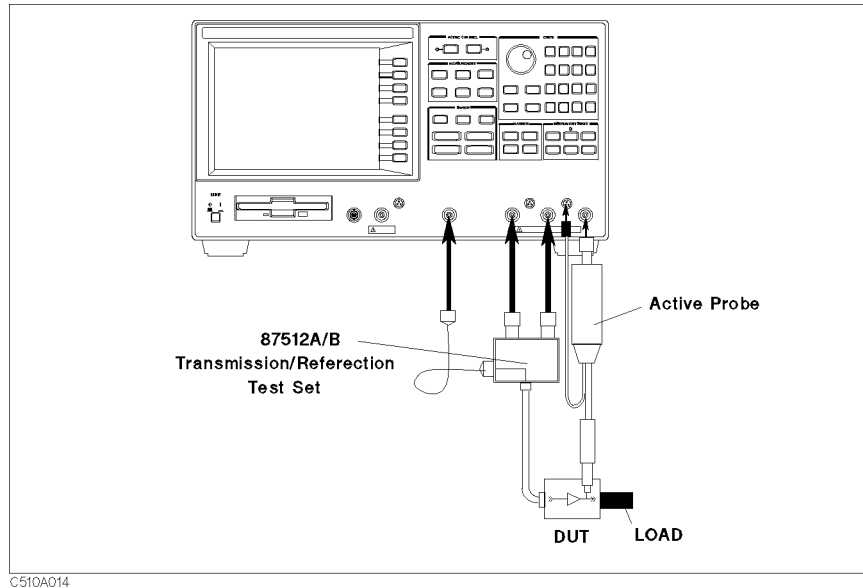
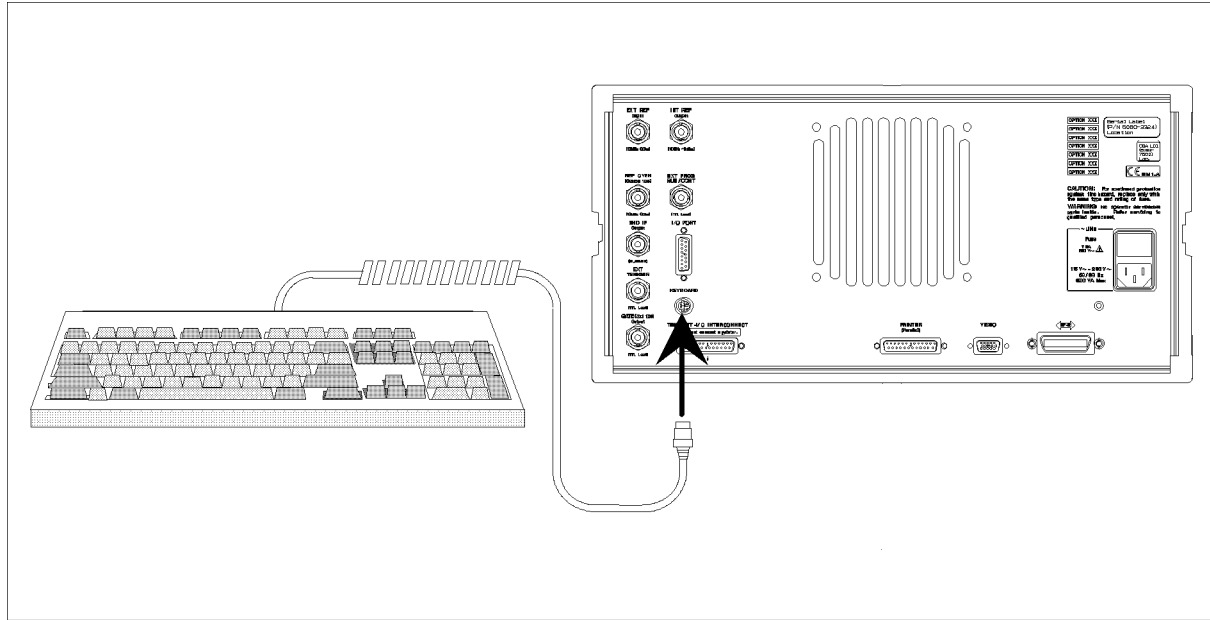

Figure 1-8. Using a Transmission/Reflection Test Set

1. Connect the 87512A/B T/R test set.
2. Connect the active probe to the B input.
3. If necessary, terminate the DUT with a load.

Connecting a Keyboard

An mini-DIN keyboard can be connected to the mini-DIN connector on the rear panel of the analyzer. The mini-DIN keyboard provides an easier way to enter characters for the file names, display titles, and Instrument BASIC programs. It can also access the analyzer softkey functions by using keyboard function keys. For more information on the mini-DIN keyboard, see *Using HP Instrument BASIC with the 4396B*.



CB10A016

Figure 1-9. Connecting a Keyboard

Setting Up a 75 Ω Measurement For Spectrum Analyzer Mode

Note



This operation requires the option 1D7 50 Ω to 75 Ω Input Impedance Conversion. For detail information about option 1D7, see chapter 9 of the *Function Reference* manual.

1. Attach the 11852B Option C04 50 Ω (m)/75 Ω N(f) minimum loss pad to the S input. This minimum loss pad is furnished with the option 1D7.
2. Press **Cal**.
3. Press **INPUT Z**.
4. Press **↑** to set the impedance of the source (75 Ω). Then press **Entry Off**.

Note



Perform this procedure each time the analyzer is preset because the analyzer does not retain this setting in memory.

Spectrum Analyzer Tour

In this chapter, you explore the spectrum analyzer mode of operation. Before starting this tour, verify the analyzer is correctly installed (see chapter 1, “Installation and Setup Guide,” if you need additional information).

Before You Leave On The Tour

On this tour, you will learn how to make a basic spectrum analyzer measurement by measuring the CAL OUT signal of the analyzer.

Overview

The following is a short summary of the tour:

1. Preparing for a measurement
 - Turning ON the analyzer
 - Connecting the test signal source
2. Setting up the analyzer
 - Setting the active channel
 - Selecting the analyzer type
 - Selecting the input
 - Setting the frequency range
3. Making a Measurement
 - Reading the peak level using the marker
 - Setting the resolution bandwidth to see low level signals
 - Searching for harmonics using the search function
4. Saving and recalling the analyzer settings
 - Preparing the disk
 - Saving analyzer settings
 - Entering the file name
 - Recalling the analyzer settings

After you finish this tour, you will understand how to make a basic measurement in the spectrum analyzer mode of operation. If you want to learn how to perform more complex tasks, see the *Task Reference* manual.

Required Equipment

To perform all the steps in this tour, you must have the following equipment:

- 4396B Network/Spectrum Analyzer
- N to BNC Adapter (50 Ω)*
- BNC cable*
- 3.5 inch 2HD (or 2DD) Blank Disk

* Furnished with the analyzer.

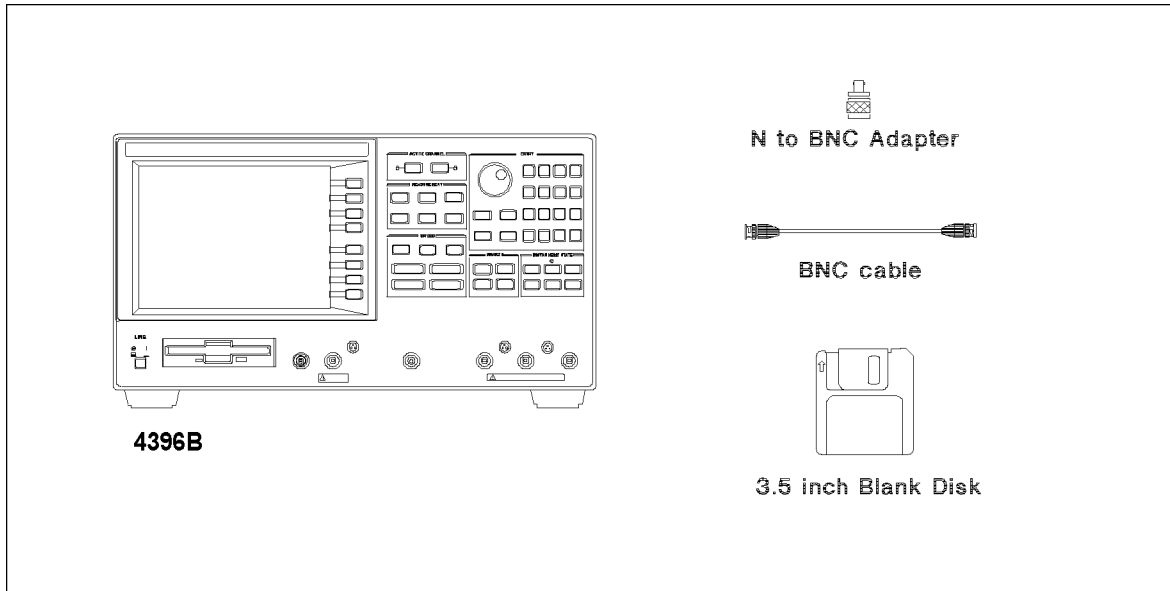

CB101009

Figure 2-1. Required Equipment

Step 1: Preparing for a Measurement

Turning ON the analyzer

Verify the power line setting is correct before you turning ON the analyzer. If necessary, see chapter 1, “Installation and Setup Guide.”

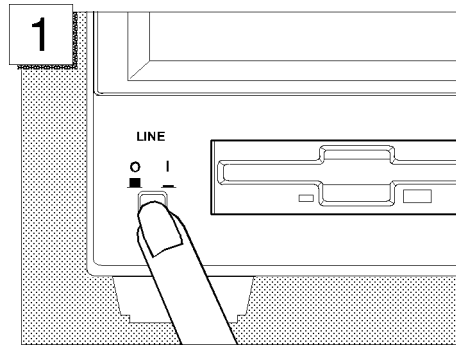

Press the LINE switch

The power on self-test takes about 10 seconds. If the analyzer is operating correctly, the following information is displayed on the LCD:

Connecting the Test Signal Source

In this tour, you use the front-panel CAL OUT signal as the test signal (20 MHz at -20 dBm).

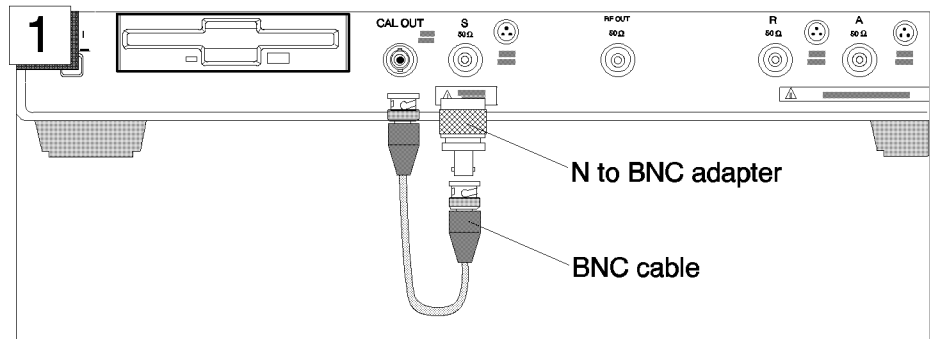

Connect the CAL OUT output to the S input using the N-to-BNC adapter and the BNC cable.

Step 2: Setting Up the Analyzer

In this step, you will set the following parameters:

Active channel	Channel 2
Analyzer type	Spectrum analyzer mode
Input	S input
Frequency Range	0 Hz to 80 MHz

Setting the Active Channel

The analyzer has two measurement channels. This allows you to have two different measurement setups. Other selections you make on the front panel affect only the active channel. To set the active channel to channel 2:

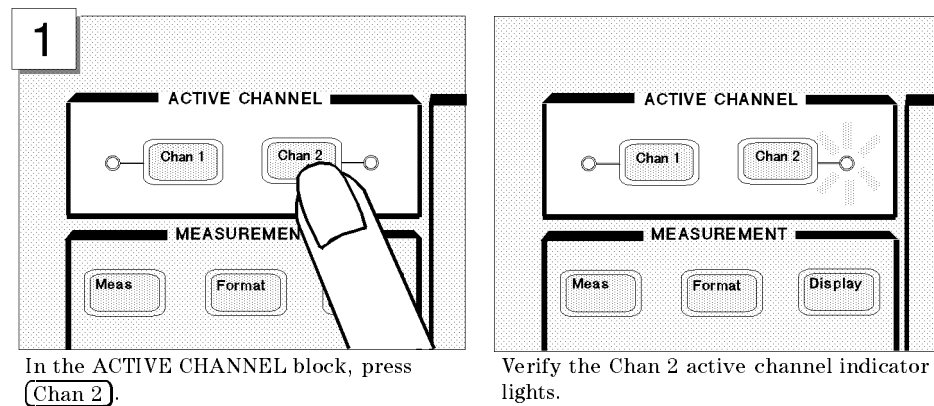

Note



All selected settings are stored separately for each channel. You must select an active channel (1 or 2) before you can change the measurement setup for that channel.

Setting the Analyzer Type

To use the spectrum analyzer mode, you must set the analyzer type to the spectrum analyzer mode after selecting an active channel.

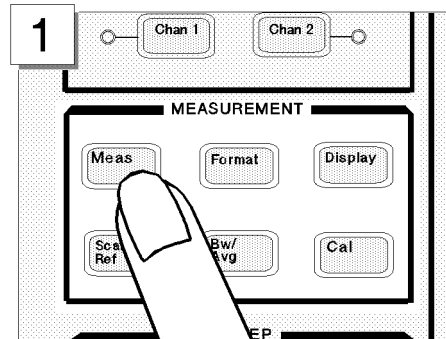

In the MEASUREMENT block, press **Meas**.

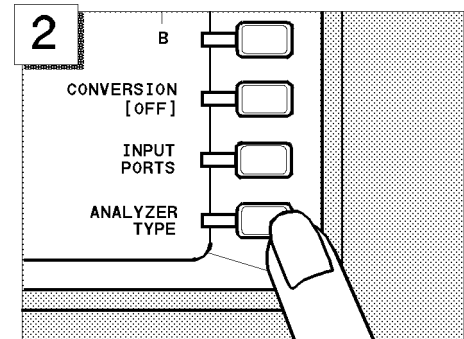

Press **ANALYZER TYPE**.

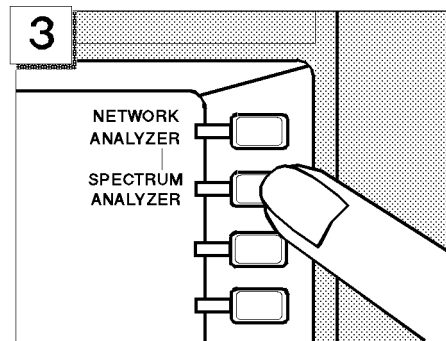

Press **SPECTRUM ANALYZER**.

Note



Changing the analyzer type presets the analyzer for the active channel. If you want to keep the current measurement settings when changing the analyzer type, first set the other channel to active.

Selecting the Input

The analyzer has four inputs; S, R, A, and B. In most spectrum measurements, the S input is used. The R, A, and B inputs can also be used for a spectrum measurement, but the dynamic range of these inputs is 20 dB worse than the S input and the attenuator is not variable. Therefore, to get the most accurate results, you should use the S input for spectrum measurements.

In the spectrum analyzer mode, the S input is selected by default. In the following steps, you verify the S input is selected.

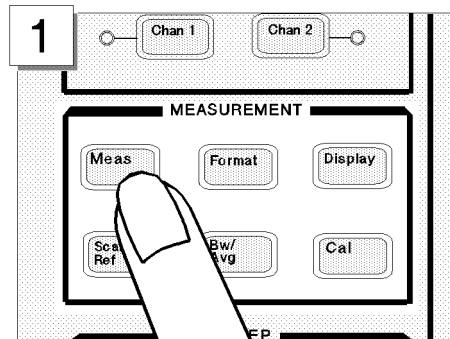

In the MEASUREMENT block, press **Meas**.

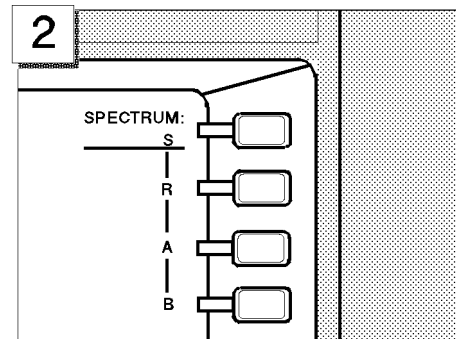

Verify the **S** in SPECTRUM: **S** is underlined. (This shows that the S input is selected for a spectrum analyzer measurement.)

Setting the Frequency Range

The CAL OUT signal (20 MHz at -20 dBm) is connected as test signal source. To see this signal on display, you must set the appropriate frequency range (in this case, 0 to 80 MHz):

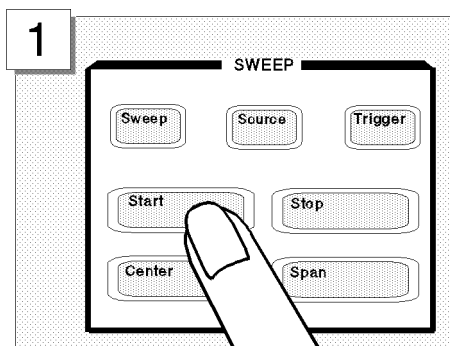

In the SWEEP block, press **Start**.

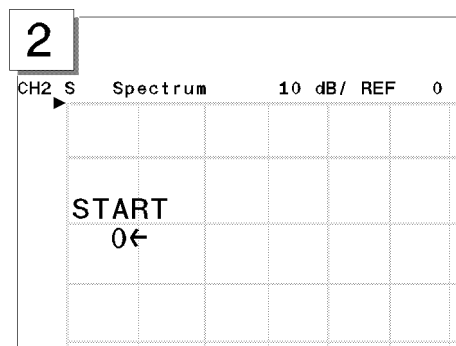

Press **0**.

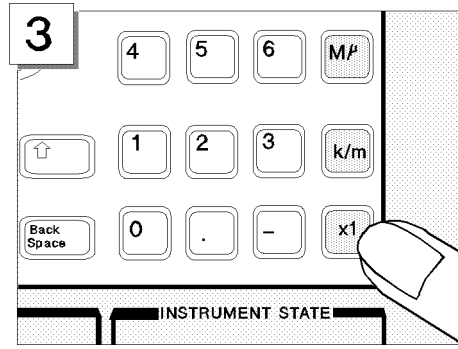

Press **x1**.

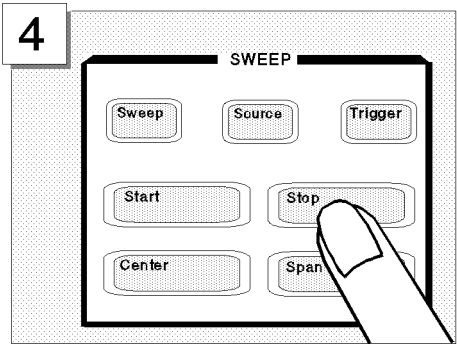

Press **Stop**.

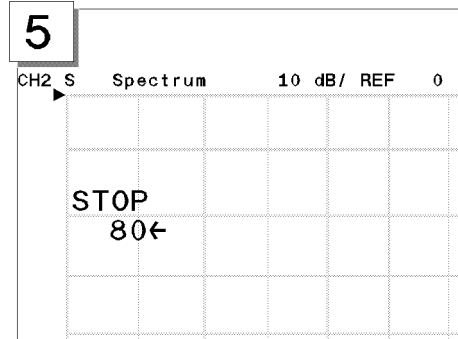

Press **S 0**.

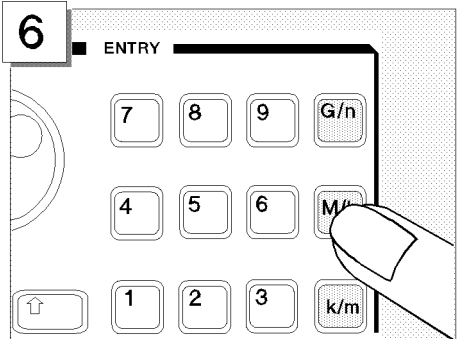

Press **M/μ**.

Verify the 20 MHz signal is displayed as shown below:

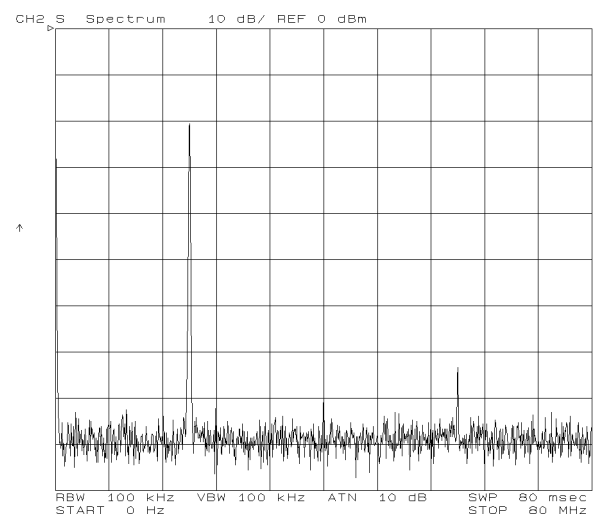

Step 3: Making a Measurement

Reading the Peak Level Using the Marker

Let's try to read peak signal level by using the marker:

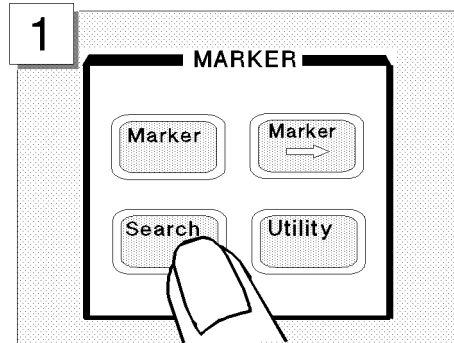

Press **Search**.

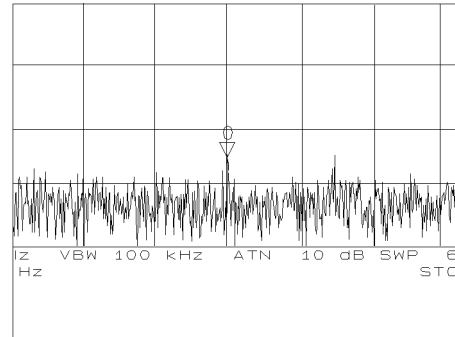

Marker appears on trace.

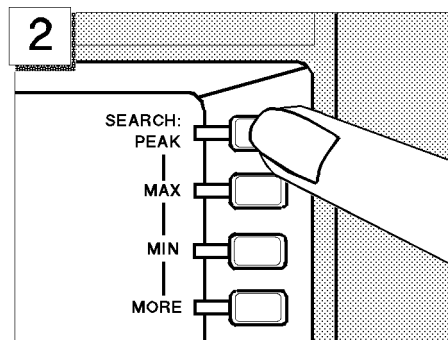

Press **SEARCH:PEAK**.

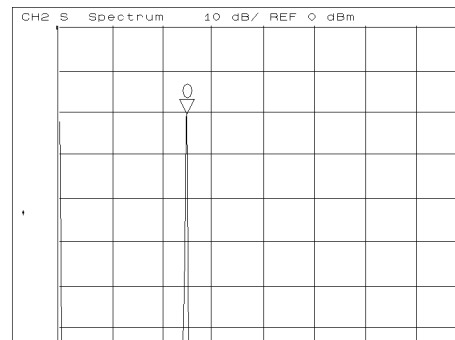

Marker moves to the top of the CAL OUT signal.

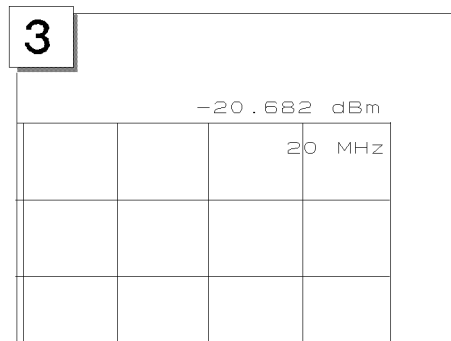

Read the marker value shown at the upper right of grid.

Setting the Resolution Bandwidth to See Low Level Signals

To see lower level signals that are approximately the same level as the noise floor level, use a narrow resolution bandwidth (RBW) setting.

Before you set the RBW, set the maximum peak level as the reference level. This increases the visibility of the lower level signal. This technique is useful when you are measuring two signals and one is very close to the noise level.

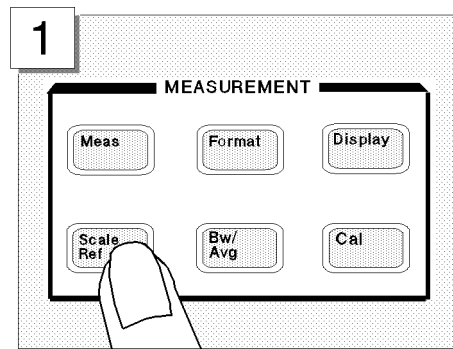

Press **Scale Ref**.

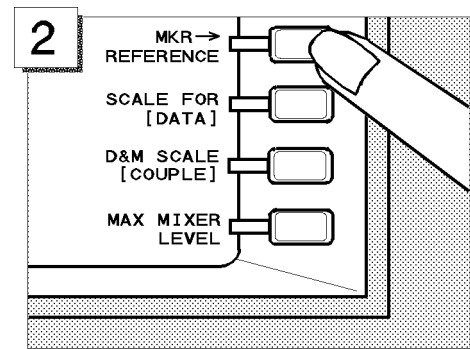

Press **MKR->REFERENCE**.

The trace moves upward to place the tip of the maximum peak at the top line of the grid.

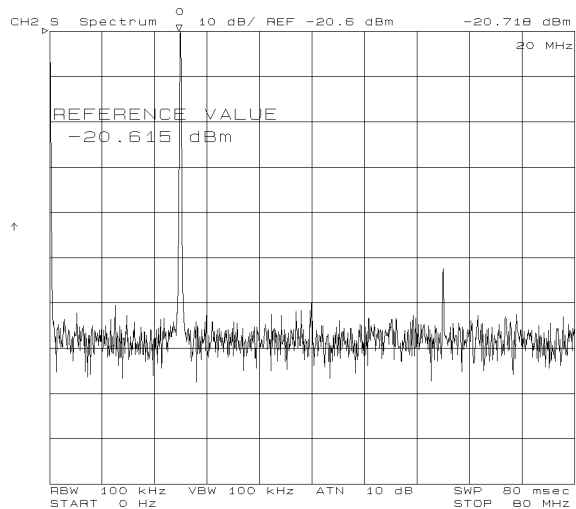

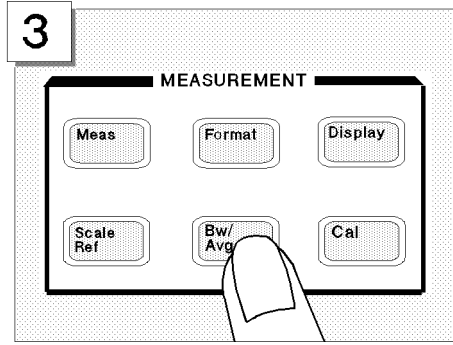

Press **Bw/Avg**.

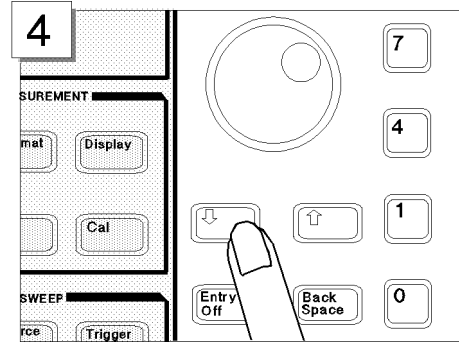

Press **3** to narrow RBW setting to 3 kHz.

Now, with the noise floor level lowered by narrowing the resolution bandwidth, the second and third harmonics can be seen as shown below:

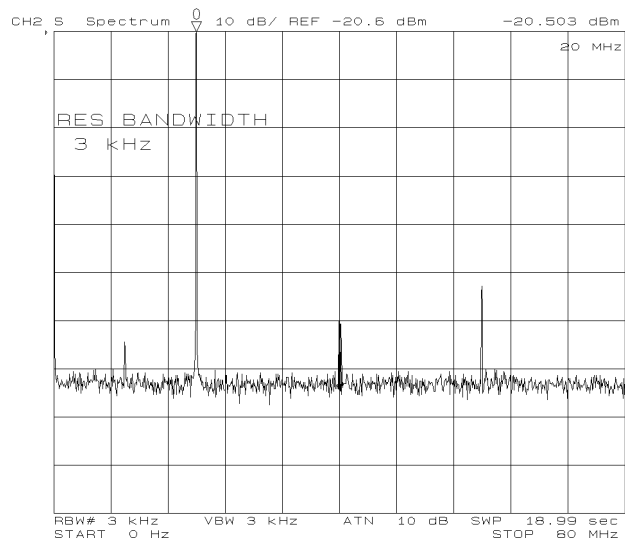

Searching for Harmonics Using the Search Function

You can easily readout a harmonics' frequency and level by using the peak search function:

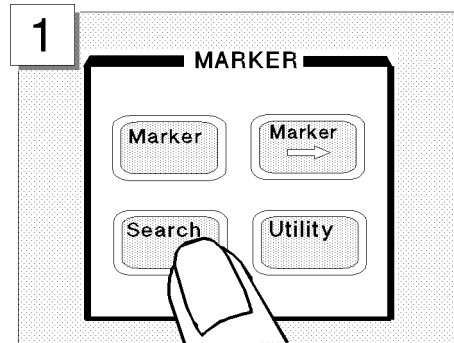

Press **Search**.

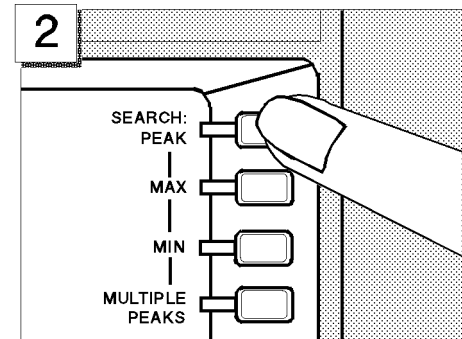

Press **SEARCH:PEAK**.

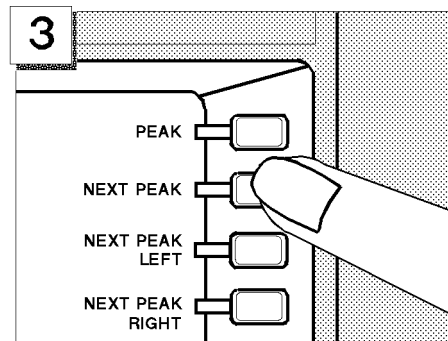

Press **NEXT PEAK**.

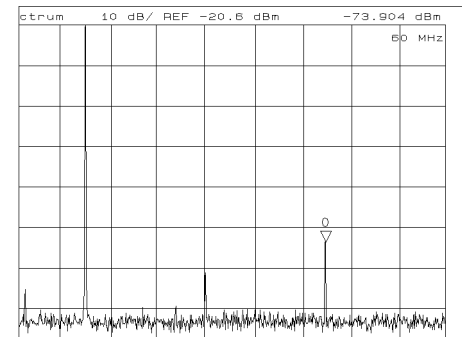

The marker moves to the third harmonic.

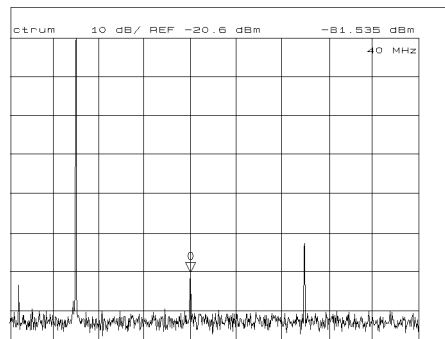

To move the marker to the second harmonic, press **NEXT PEAK** again.

Step 4: Saving and Recalling Analyzer Settings

You can store the settings or measurement data on a 3.5 inch disk using the analyzer's disk drive. In this tour, you save and recall the settings that you selected previously in this tour.

Preparing the Disk To use a disk, you must first initialize it by performing the following steps:

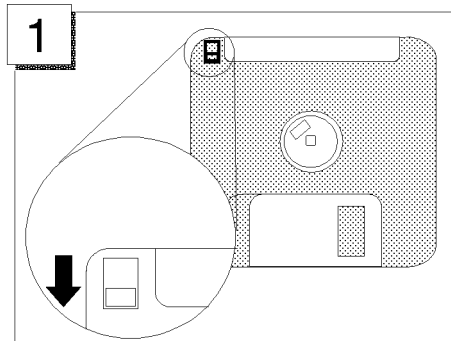

Verify the disk is not write protected.

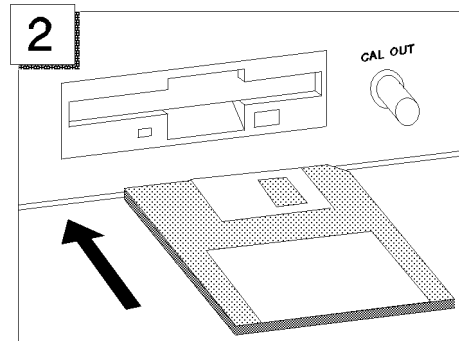

Insert the disk into the disk drive

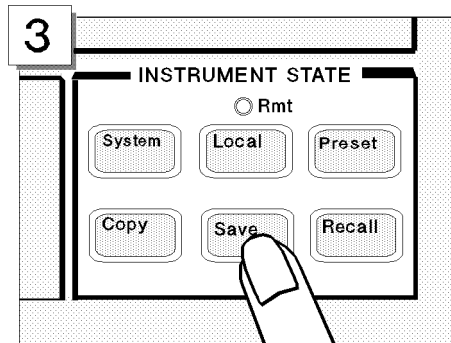

Press **Save**.

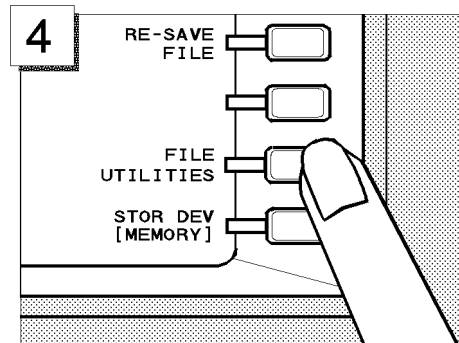

Press **FILE UTILITIES**.

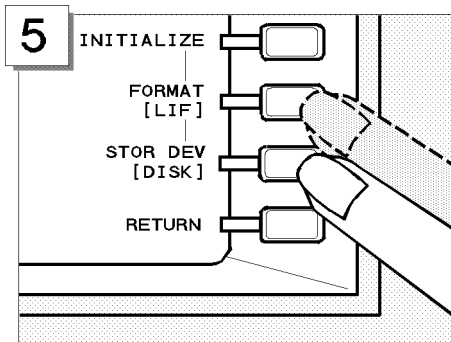

Toggle **FORMAT [DOS]** to **[LIF]** and **STOR DEV [MEMORY]** to **[DISK]**.

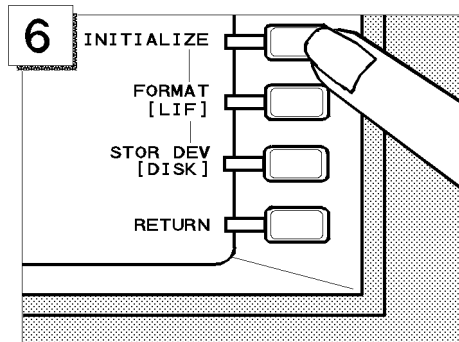

Press **INITIALIZE DISK**.

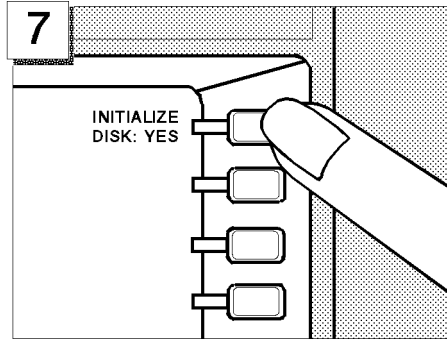

Press **INITIALIZE DISK: YES**.

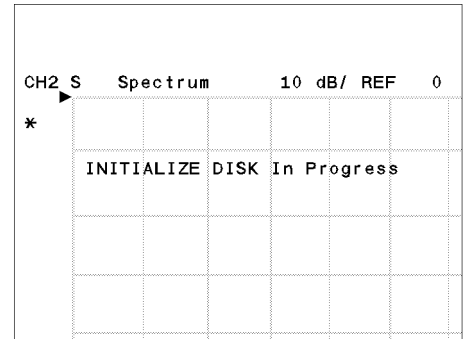

The message, "INITIALIZE DISK In Progress," is displayed. After the disk is initialized, this message is turned off.

Note



The analyzer can use either a LIF (Logical Interchange Format) or a DOS (Disk Operating System) format disk.

Saving Analyzer Settings

In the following example, use "SATOUR" as the file name of the analyzer settings you want to save.

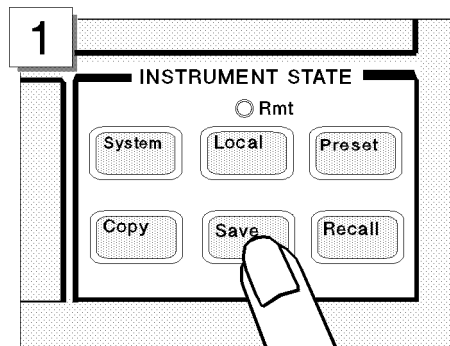

Press **Save**.

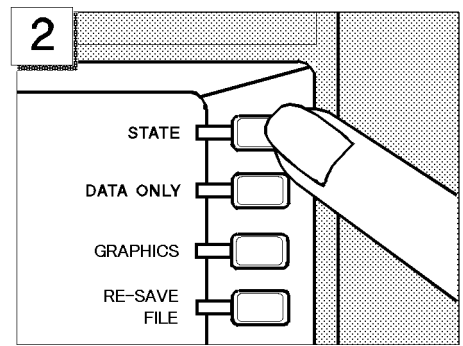

Press **STATE**.

The analyzer requests the file name you want to use for the saved settings.

Entering the File Name

Note



If a keyboard is connected, you can use it for file name entry. If not, use the front-panel controls as described in the following steps.

Note



The file name for a LIF format can be up to 10 characters long. However, with the analyzer, the last 2 characters are reserved for a suffix. Therefore, you can enter a file name of up to 8 characters. Either upper or lower case is recognized in the LIF format.

A file name for a DOS format consists of a file name and an extension. The file name can be up to 8 characters long and the extension contains up to 3 characters. A period separates the extension from the file name. The extension part reserved by the analyzer. Therefore, you can enter a file name of up to 8 characters. The file name is not case sensitive in the DOS format.

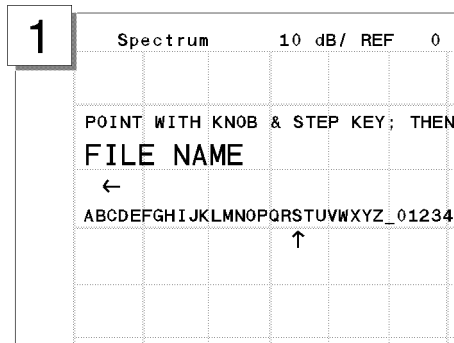

Turn the rotary knob to move the arrow below the first character, S.

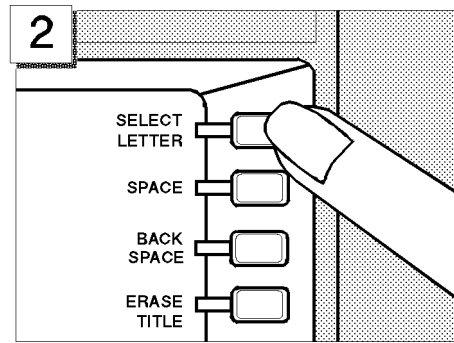

Press **SELECT LETTER**.

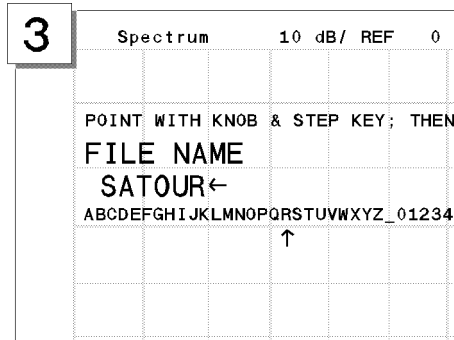

Keep entering characters until SATOUR is entered.

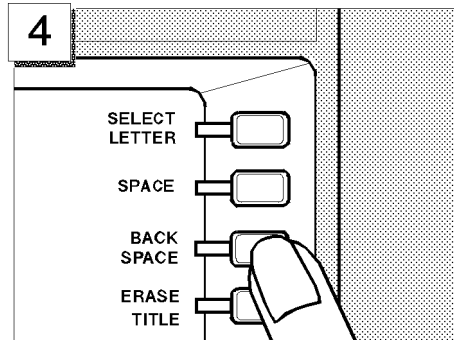

If you enter a wrong character, press **BACK SPACE** to erase the character.

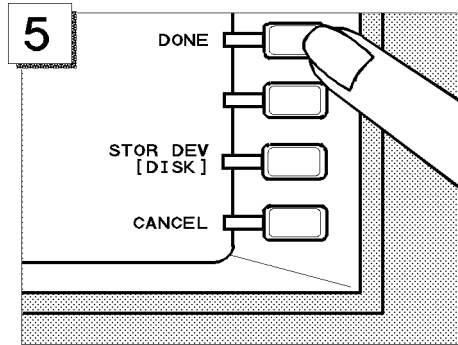

To complete the file name entry, press **DONE**.

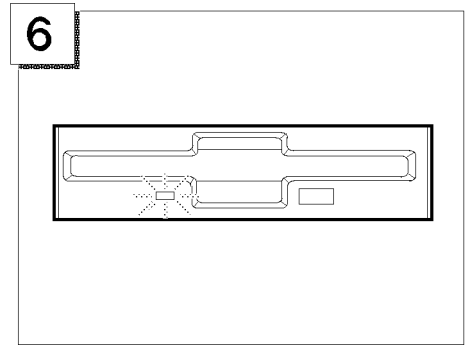

Verify the disk access indicator lights (this shows that the analyzer is saving the settings to the disk).

Recalling the Analyzer Settings

You can recall the file containing the saved analyzer settings anytime you want. This is true, even if you change the current analyzer settings. In this example, you will preset the analyzer and then recall the settings in the SATOUR file.

Presetting

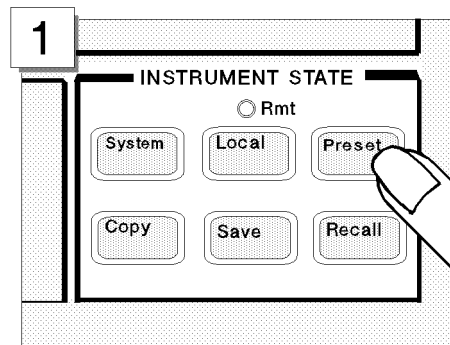

Press **Preset**.

The analyzer is set to the preset conditions. However, the analyzer settings from the previous examples are stored in the SATOUR file on the disk.

Recalling the SATOUR file.

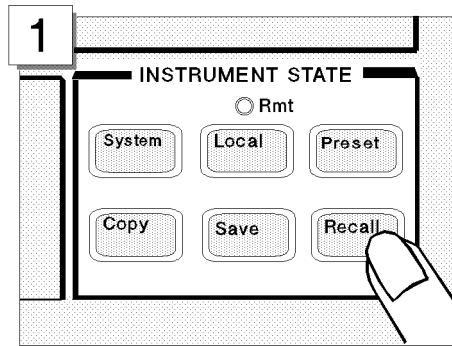

Press **Recall**.

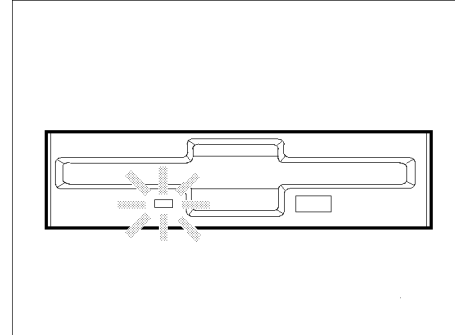

The disk access lamp lights.

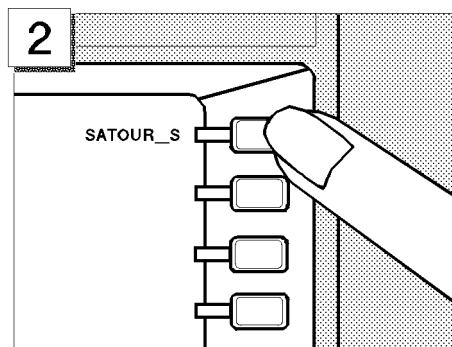

The stored file is listed in the softkey label area. Press **SATOUR_S** to recall the analyzer settings that you saved.

Note



Suffix, “_S,” means the analyzer settings are saved. If you save the analyzer settings in a DOS format, an extension, “.sta,” is appended to the file name.

After the disk access lamp goes out, all analyzer settings that you set are recalled. You can verify them on the display. If you want to know what settings are saved, see chapter 8 of the *Function Reference* manual.

Network Analyzer Tour

In this chapter, you explore the network analyzer mode of operation. Before starting this tour, verify the analyzer is correctly installed (see chapter 1, “Installation and Setup Guide,” if you need additional information).

Before You Leave On The Tour

On this tour, you will learn how to make a basic network analyzer measurement by measuring the transmission characteristics of a bandpass filter.

Overview

The following is a short summary of the tour:

1. Preparing for a measurement
 - Turning ON the analyzer
 - Connecting the DUT
2. Setting up the analyzer
 - Setting the active channel
 - Selecting the analyzer type
 - Setting the input port
 - Setting the frequency range
 - Performing the automatic scaling
3. Making a calibration
4. Reading a measurement result
 - Reading a measured value by using marker
5. Printing out the measurement result
 - Configuring and connecting a printer
 - Making a hardcopy of the display

After you finish this tour, you will understand how to make a basic measurement in the network analyzer of operation. If you want to learn how to perform more complex tasks, see the *Task Reference* manual.

Required Equipment

To perform all the steps in this tour, you must have the following equipment:

- 4396B Network/Spectrum Analyzer
- Measurement Device:
 - This tour assumes the device under test (DUT) is a 70 MHz bandpass filter
- THRU (BNC female-to-female connector)
- Two BNC cables
- Test Set (use either of the following)
 - Transmission/Reflection (T/R) Test Set
 - Two N-to-BNC adapters
 - S-Parameter Test Set
 - Two APC7-to-N adapters
 - Two N-to-BNC adapters
- HP DeskJet Printer *
- Parallel Interface Cable *

* If you do not have an DeskJet printer and cable, skip step 5, "Printing Out the Measurement Results".

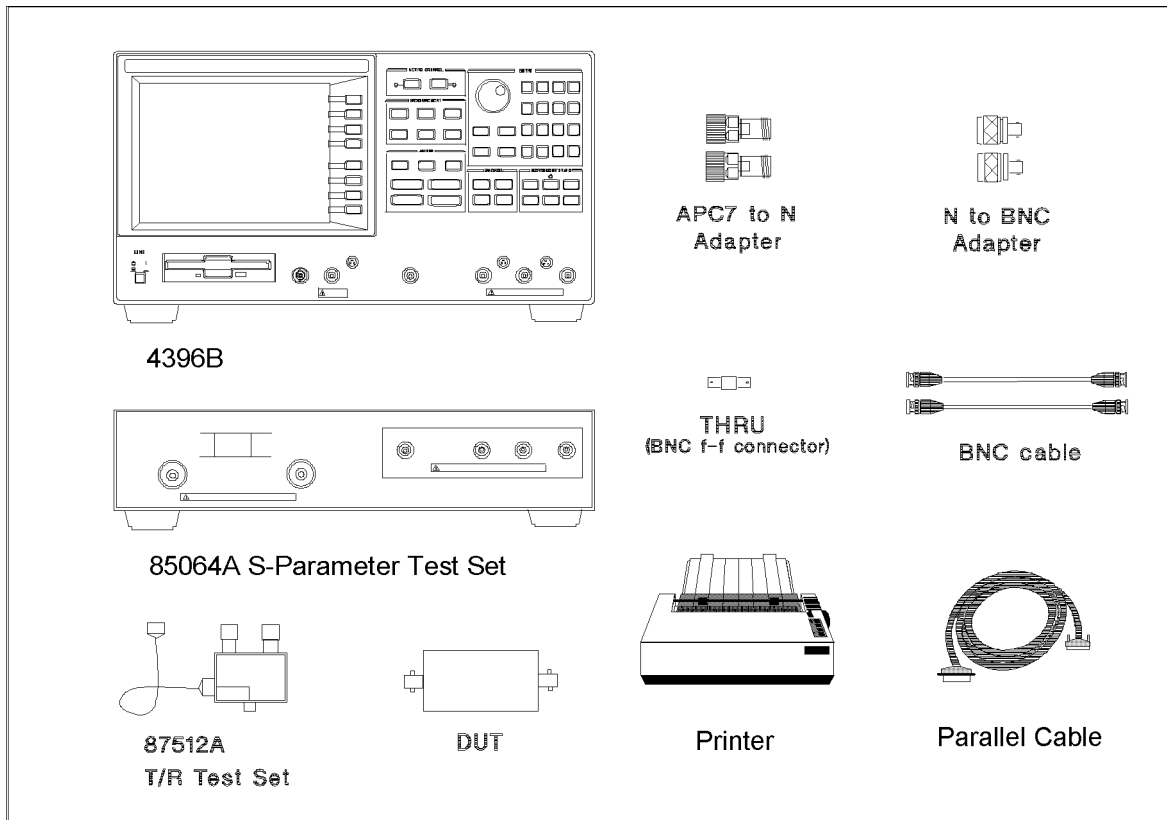

CB100301

Figure 3-1. Required Equipment

Step 1: Preparing for the Measurement

You must set up the test set before you turn ON the analyzer. The setup procedure for the test set is described in “Connecting a Test Set for Network Analyzer Mode” in Chapter 1.

Turning ON the Analyzer

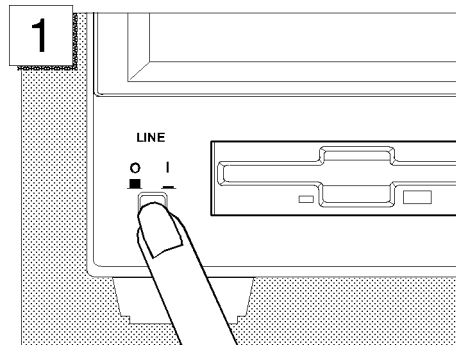

Press the LINE switch.

The power on self-test takes about 10 seconds.

Connecting the DUT Connect the DUT as shown in Figure 3-2 or Figure 3-3.

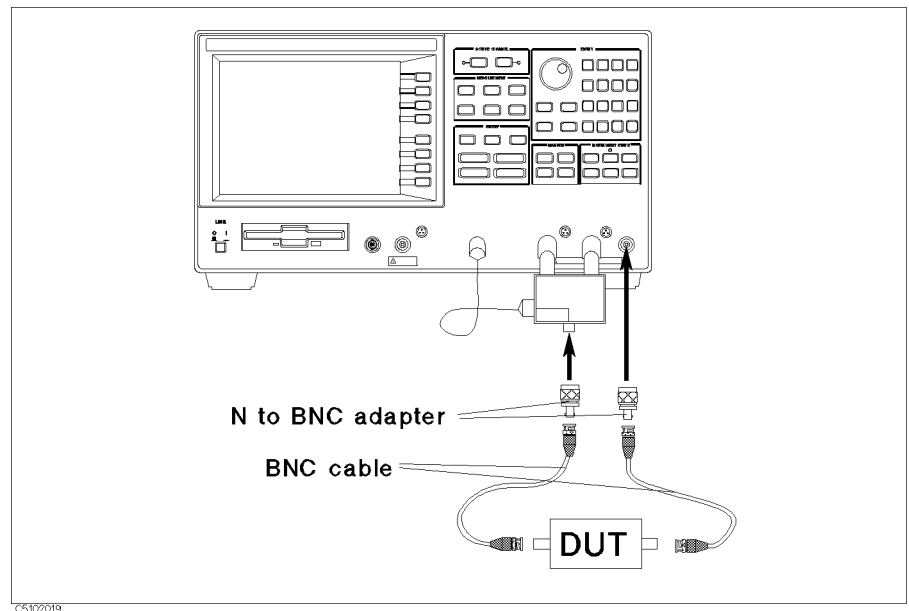

Figure 3-2. Transmission/Reflection Test Set Setup

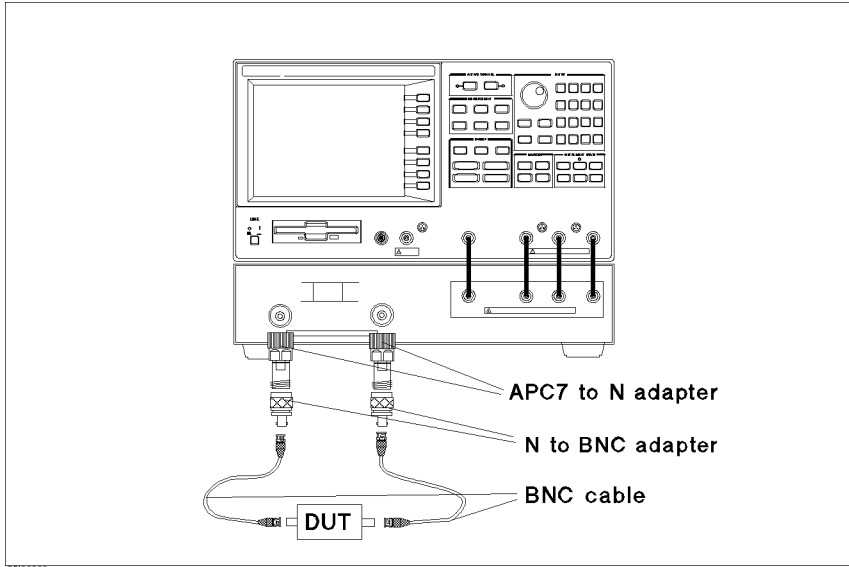

Figure 3-3. S-Parameter Test Set Setup

Step 2: Setting up the Analyzer

Before you start the measurement, you must set up the analyzer to fit your measurement requirements. For example, you must set the frequency range of the measurement. In this step, you will set the following parameters:

Active channel	Channel 1
Analyzer type	Network analyzer mode
Inputs	B/R or S_{21} (depending on the test set)
Format	Log magnitude (default)
Frequency Range	Center 70 MHz, Span 500 kHz

Setting the Active Channel

Because the analyzer has two measurement channels you can have two different measurement setups at the same time. To change the active channel to channel 1:

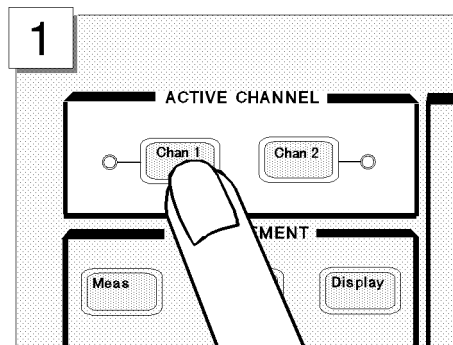

In the ACTIVE CHANNEL block, press **Chan 1**.

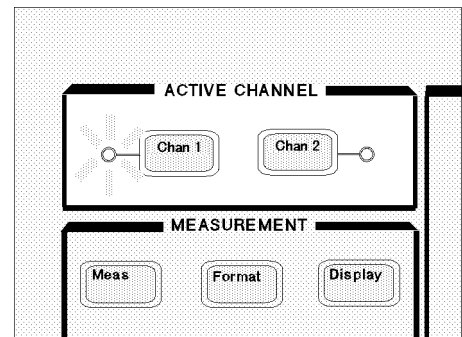

Verify the Chan 1 active channel indicator lights.

Setting the Analyzer Type

To use the analyzer in the network analyzer mode, you must set the analyzer type to the network analyzer mode after selecting the active channel.

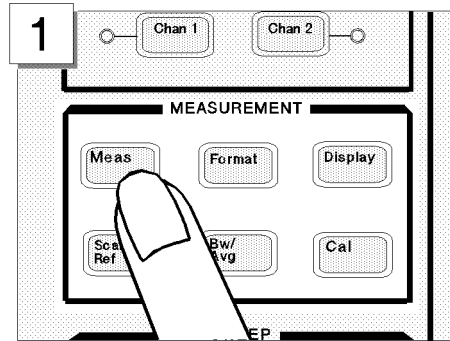

In the MEASUREMENT block, press **Meas**.

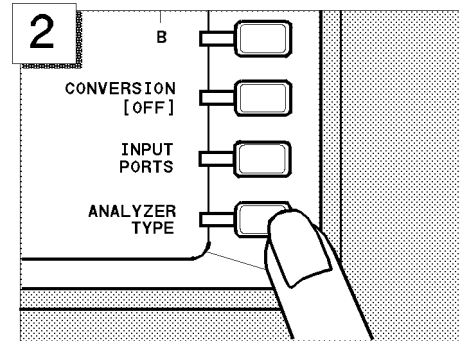

Press **ANALYZER TYPE**.

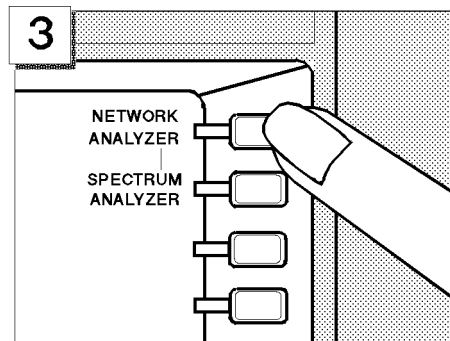

Press **NETWORK ANALYZER**.

Selecting the Input

The analyzer uses three inputs for network measurements (R, A, and B). Usually, the R input accepts the RF OUT signal directly, the A input receives the reflection signal from the DUT, and the B input receives the transmission signal through the DUT.

This example assumes you are using the T/R test set. Therefore, because you are going to measure the transmission characteristics of the DUT, select B/R to measure the ratio of B and R inputs.

When you use the S-parameter test set, you can measure the forward and reverse characteristics of a 2-port device without reconnecting the inputs. In that case, select S_{21} for a transmission measurement in the forward direction.

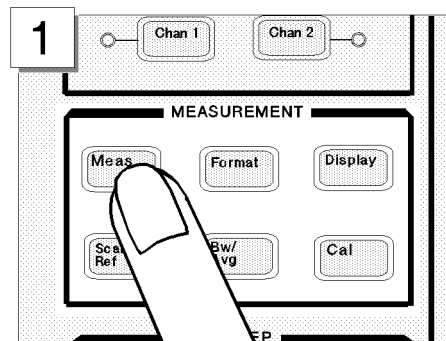

In the MEASUREMENT block, press **Meas**.

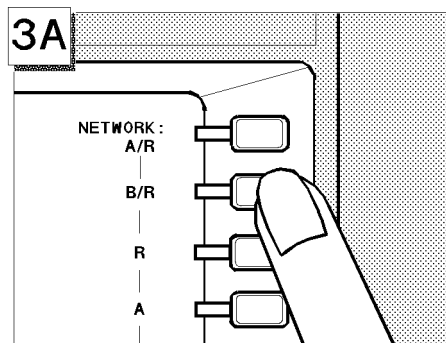
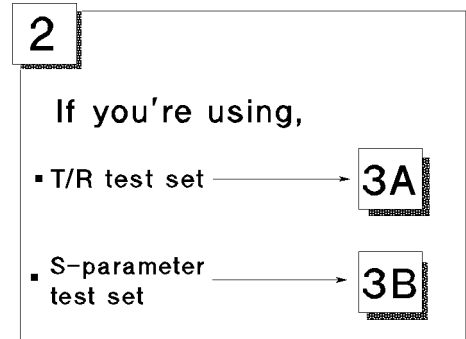

Press **B/R**.

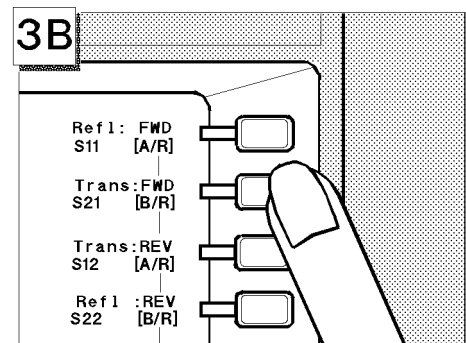

Press **Trans:FWD S21 [B/R]** to select B/R for the forward direction.

Setting the Frequency Range

To display the transmission characteristics of the 70 MHz bandpass filter, you should specify the frequency range for the measurement. In this example, set the analyzer to a 70 MHz center frequency with a 500 kHz span.

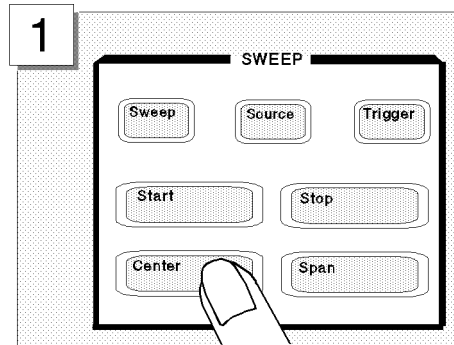

In the SWEEP block, press **Center**.

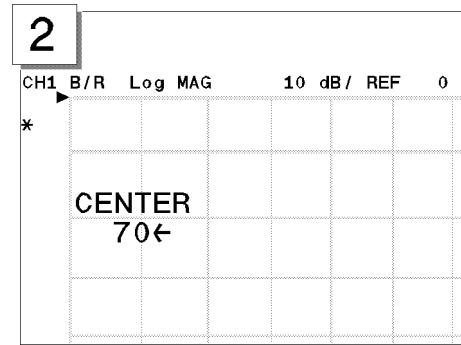

Press **7 0**.

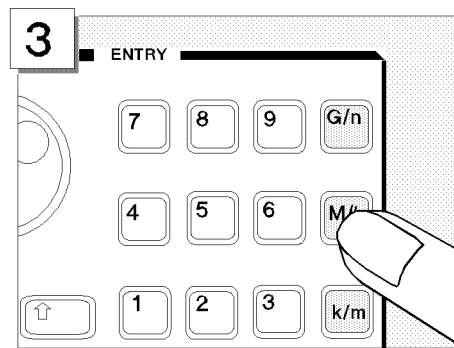

Press **M/μ**.

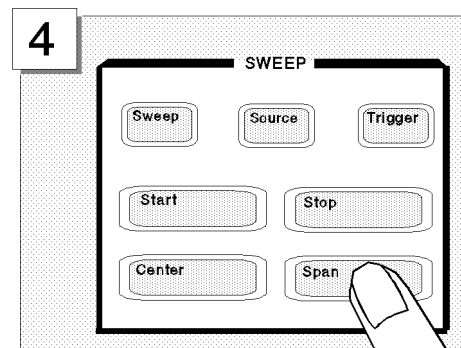

In the SWEEP block, press **Span**.

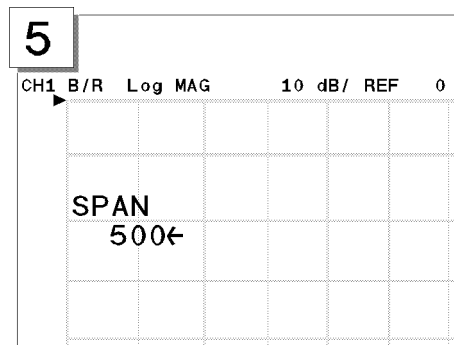

Press **5 0 0**.

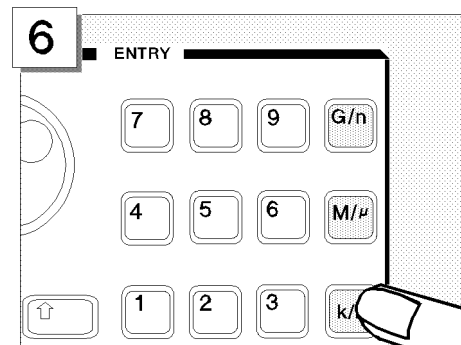

Press **k/m**.

Performing the Automatic Scaling

Often, the trace obtained after specifying the frequency range is too large or too small vertically for the grid. However, by using the automatic scaling function, you can obtain the optimum vertical setting automatically.

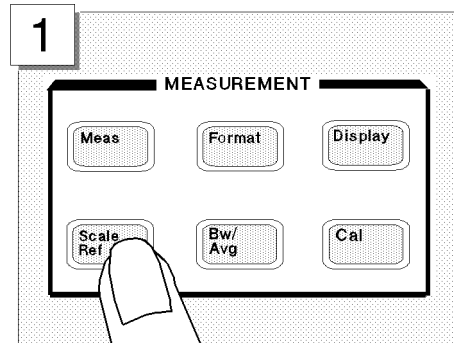

In the MEASUREMENT block, Press **Scale Ref**.

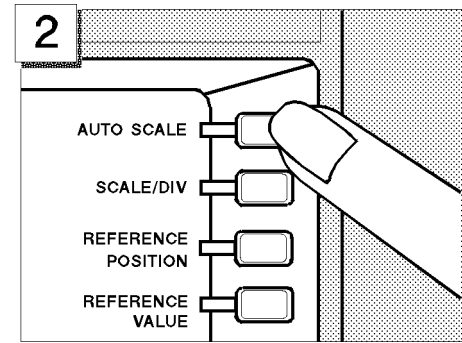

Press **AUTO SCALE**.

The transmission characteristics trace of the filter is displayed as shown below:

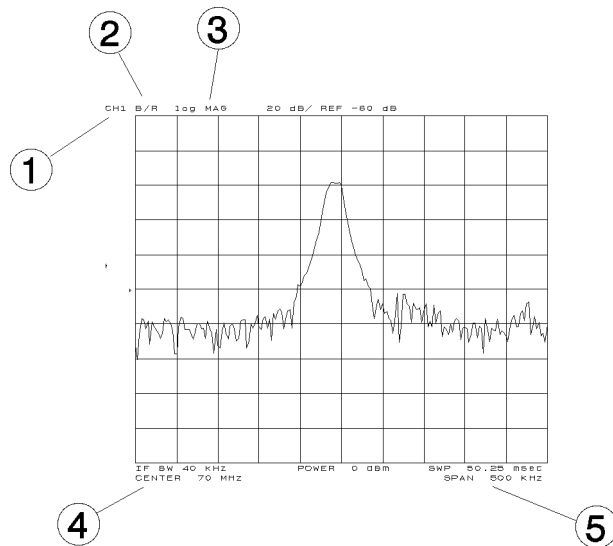

All the settings are displayed on the LCD.

1. Active channel is set to channel 1.
2. Inputs are set to B/R.
3. Format is set to log magnitude mode.
4. Center frequency is set to 70 MHz.
5. Frequency span is set to 500 kHz.

Step 3: Making a Calibration

To ensure accurate measurement results, calibrate the analyzer before making a measurement. Calibration reduces error factor due to uncertainty. In this example, you perform the response calibration to cancel a frequency response error. A THRU (BNC female-to-female connector) is necessary to perform a response calibration for the transmission measurement.

Performing a Response Calibration (for the Transmission Measurement)

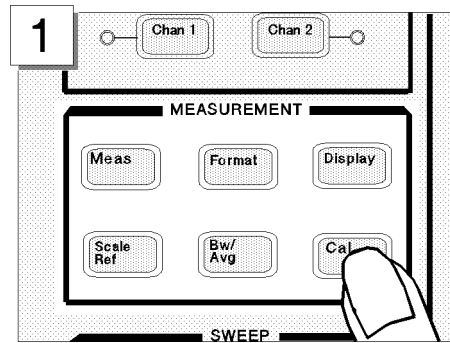

Press **Cal**.

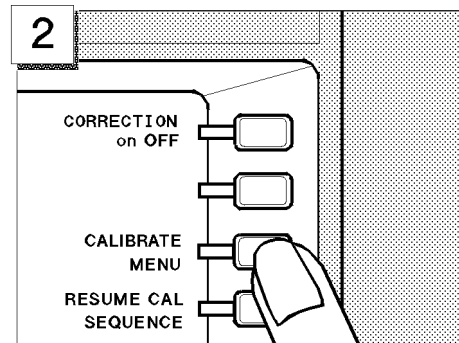

Press **CALIBRATE MENU**.

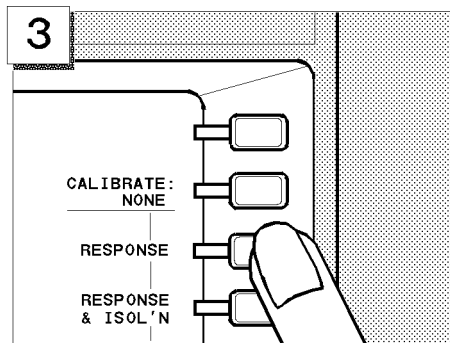

Press **RESPONSE**.

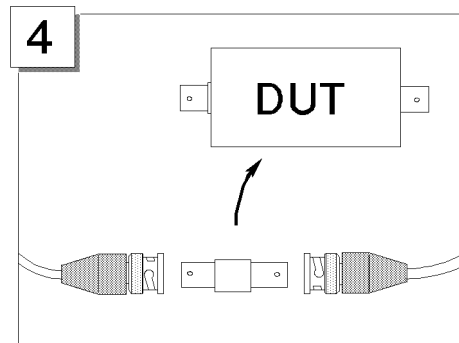

Disconnect the DUT then, connect the THRU.

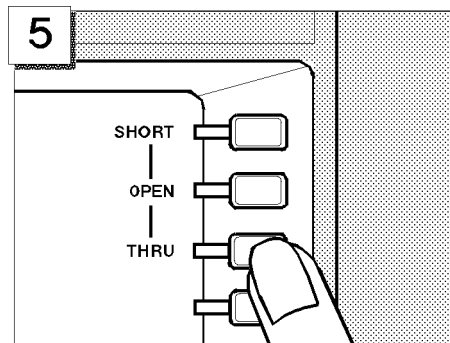

Press **THRU**.

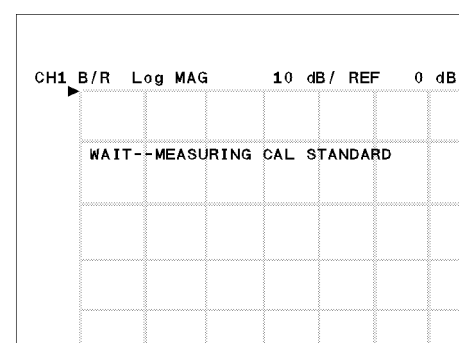

WAIT - MEASURING CAL STANDARD is displayed.

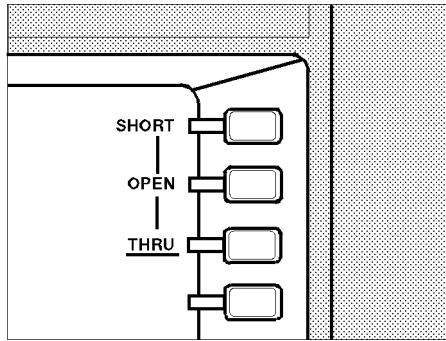

The THRU softkey label is underlined when the measurement is completed.

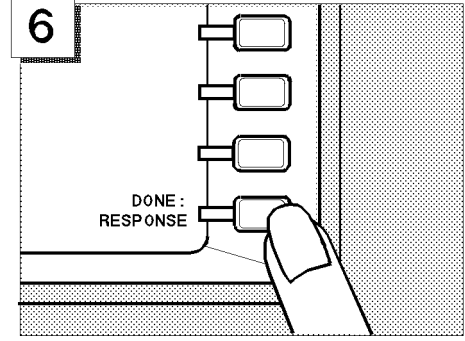

Press DONE: RESPONSE.

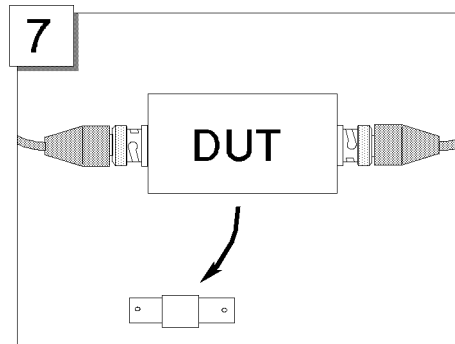

Disconnect the THRU and reconnect the DUT.

“Cor” is displayed on the left side of the display to show that the frequency response error is corrected.

The measured value is now corrected for the frequency response error.

Note



If the trace is changed, it requires an adjustment of the scale. Perform the automatic scaling again by pressing Scale Ref AUTO SCALE.

Step 4: Reading a Measurement Result

You may want to readout the measured values on the displayed trace. You can use the marker function for this purpose. The marker shows the frequency and response value at the marker point.

Reading a Measured Value by Using Marker

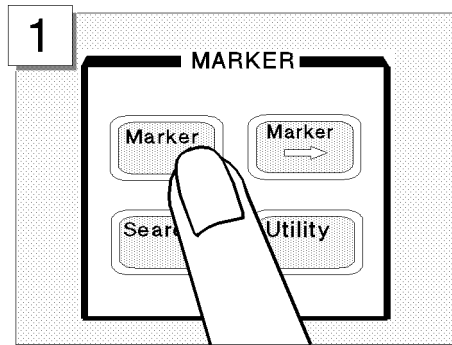

In the MARKER block, press **Marker**.

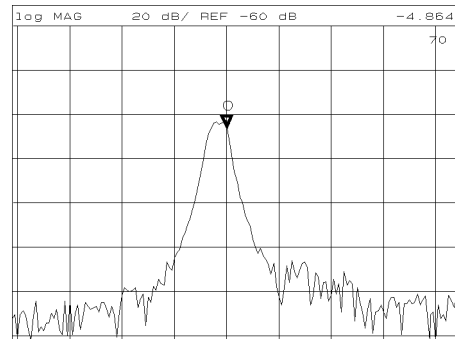

Verify a marker appears on the trace.

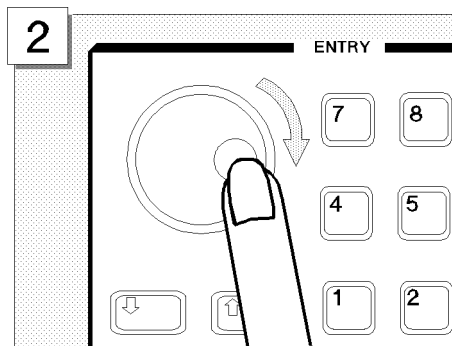

Turn the knob to the right to move the marker toward the right.

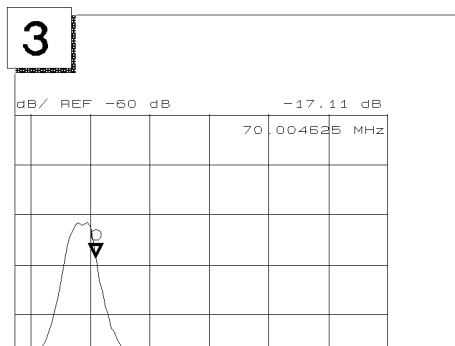

Read the values at the right top of the display.

The marker has a search function that makes it easier and faster to evaluate the trace results. For example, to search for the maximum value and its frequency on the trace:

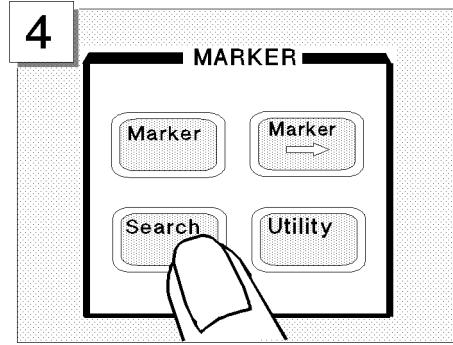

In the MARKER block, press **Search**.

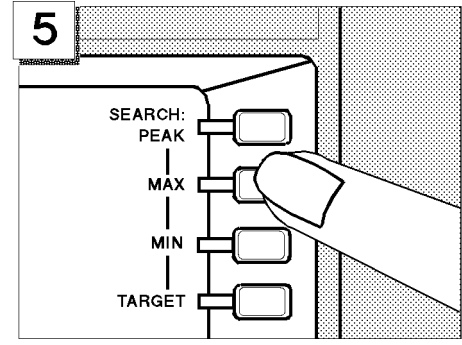

Press **MAX**.

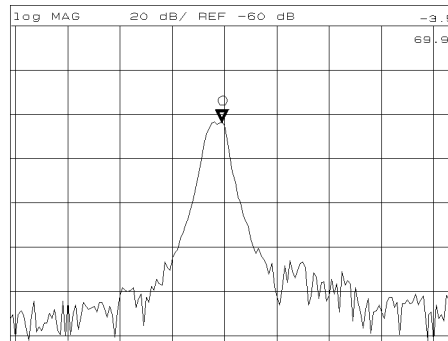

The marker immediately moves to the maximum point on the displayed trace.

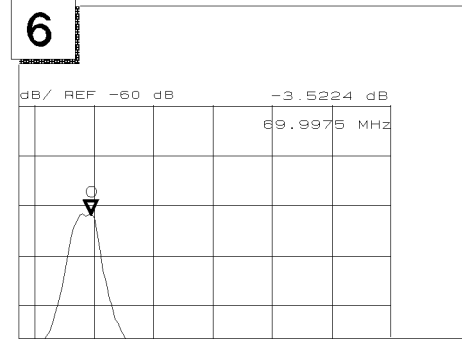

Read the frequency and response values displayed at the upper right of the display.

Step 5: Printing Out the Measurement Result

You may want a hardcopy of the measured results for a permanent record of the measurement. The analyzer can print out the data as a snapshot of the display or as a list of values without using any external controller.

Configuring and Connecting a Printer

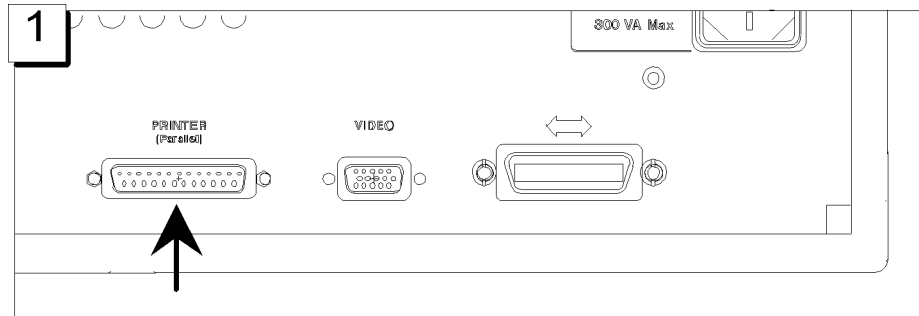

Locate the parallel interface connector on the back of the analyzer.

Note



For more information about printer, see the chapter 9 of the *Function Reference* manual.

Making a Hardcopy of the LCD Display

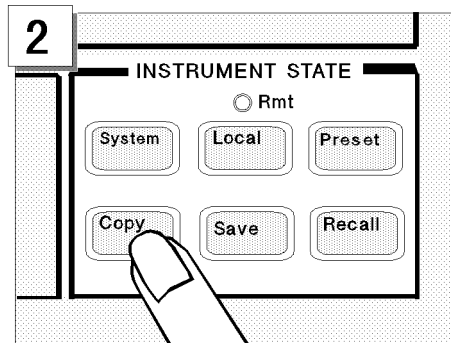

Press **Copy**.

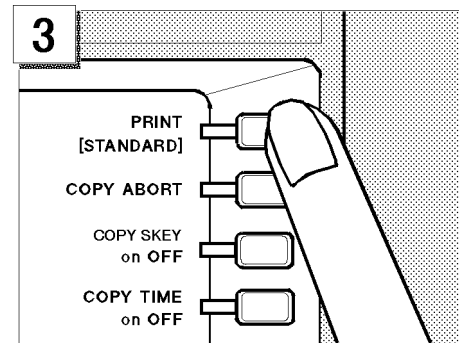

Press **PRINT [STANDARD]** to execute the printing.

Spectrum Measurement Examples

This chapter contains the following spectrum measurement examples:

- Harmonic distortion measurement
- Carrier/noise ratio (C/N) measurement
- Tracking a drifting signal
- Network measurement with spectrum monitor
- Amplitude modulation (AM) signal measurement
- Frequency modulation (FM) signal measurement
- Burst signal measurement

Basic Setup

To measure the spectrum of a test signal, use the S input as shown in Figure 4-1.

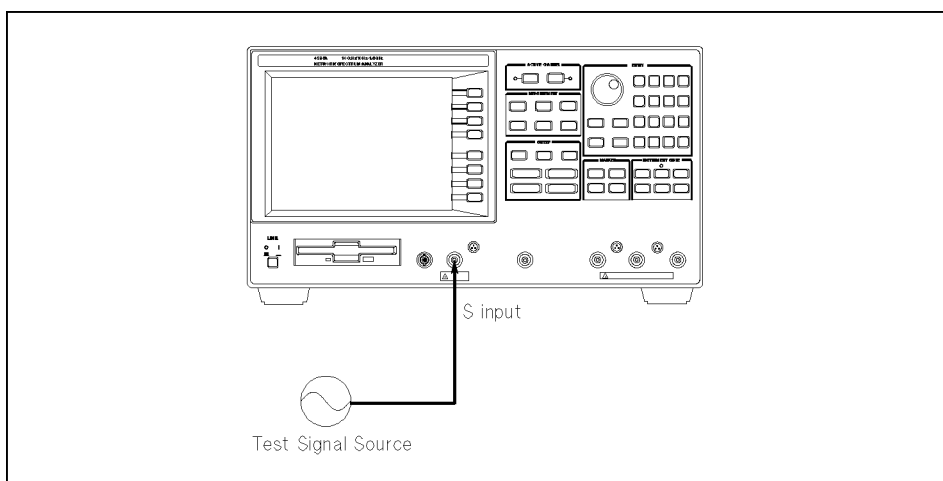

Figure 4-1. Basic Connection for Spectrum Measurement

The spectrum of input signals can also be monitored at the A, B, and R inputs. The use of the spectrum monitor function is described later in this chapter.

Harmonic Distortion Measurement

The analyzer can simultaneously display the difference values between the fundamental and harmonics up to the seventh harmonic. The test signal used in this example is the output of an amplifier with a 20 MHz sine wave input signal.

Test Signal and Test Device

The following test signal and device are used in this example.

- Input Test Signal
 - Frequency: 100 MHz
- Test Device
 - Amplifier

Measurement Setup

Connection

Set up the analyzer as shown in Figure 4-2.

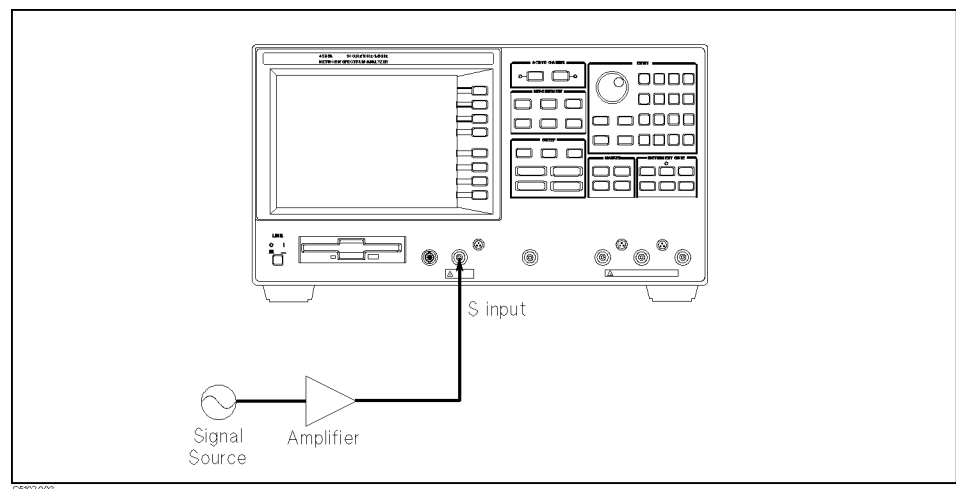

Figure 4-2. Harmonics Measurement Setup

Analyzer Settings

Press **[Preset]**. Then set the analyzer's controls as follows:

	Desired Settings	Key Strokes
Active Channel Block	Select channel 1	[Chan 1] (default)
Measurement Block	Select Spectrum Analyzer Select S input	Press [Meas] ANALYZER TYPE SPECTRUM ANALYZER [Meas] SPECTRUM:S (default)
Sweep Block	Start frequency 50 MHz Stop frequency 1.8 GHz	Press [Start] 50 [M/μ] Press [Stop] 1.8 [G/n]

Multiple Peak Search and Marker List For Harmonic Distortion Measurement

Harmonic components can be read (to 5 digits resolution) by moving the marker to each harmonic. The marker and seven sub-markers can be moved to peaks automatically. Amplitude and frequency of all markers on the trace are read at the same time. The following procedure displays the value of the fundamental and the harmonics:

1. Press **[Marker]** ΔMODE MENU TRACKING ΔMKR to turn the tracking Δmarker on. The tracking Δmarker always tracks the marker.
2. Press **[Search]** SEARCH TRK on OFF to ON off to turn the search tracking on.
3. Press **[Search]** MULTIPLE PEAKS SEARCH:PEAKS ALL to move the marker to the fundamental and turn on and move the sub-markers to individual harmonics.
4. Press **[Utility]** MKR LIST on OFF to ON off to turn marker list on. The Δmarker and all sub-marker values are displayed as shown in Figure 4-3.

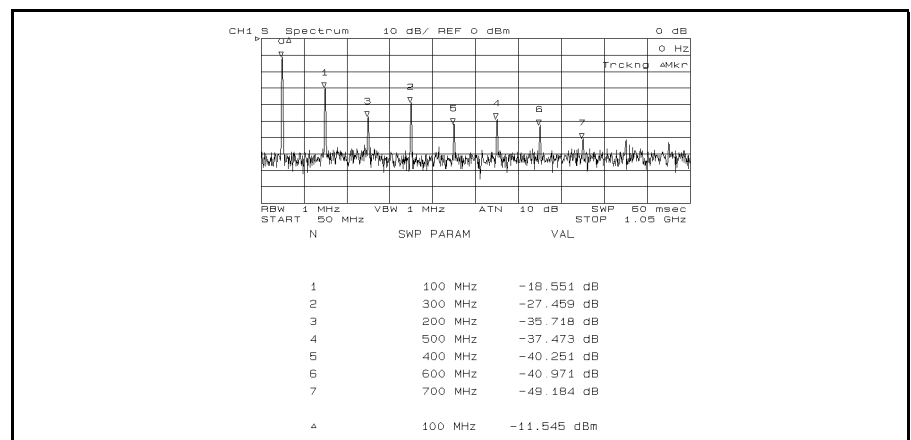

Figure 4-3.
Using Multiple Peak Search and Marker List to Measure Harmonic Distortion

5. Press **[Marker]** PRESET MKRS, when you are finished with this measurement.

C/N Measurement

C/N is the ratio of the carrier to the noise. The analyzer can measure noise level directly and read out the C/N using the marker functions. Do the “Harmonic Distortion Measurement” before doing this measurement.

Test Signal

This example uses the same test signal used in the “Harmonic Distortion Measurement” example.

Measurement Setup

Connection

This example assumes that the connections and instrument settings made in the “Harmonic Distortion Measurement” example are still in effect.

Analyzer Settings

Change the following settings for this measurement:

- Press **Center** 100 **(M/μ)** and **Span** 100 **(k/m)** to zoom to the fundamental on the display.

Fixed ΔMarker and Noise Format for C/N Measurement

1. Press **Search** **MAX** to search for the carrier.
2. Press **Scale Ref** **MKR→REFERENCE**.
3. Press **Marker** **ΔMODE MENU** **ΔMKR** 10 **(k/m)** to put Δmarker on the carrier and to move the marker to the 10 kHz offset point.
4. Press **Bw/Avg** **VIDEO BW** 10 **(×1)**.
5. Press **Utility** **NOISE FORM** on **OFF** to **ON** off. The analyzer displays the C/N ratio with the unit of “dB/Hz” at the upper right of the display as shown in Figure 4-4.

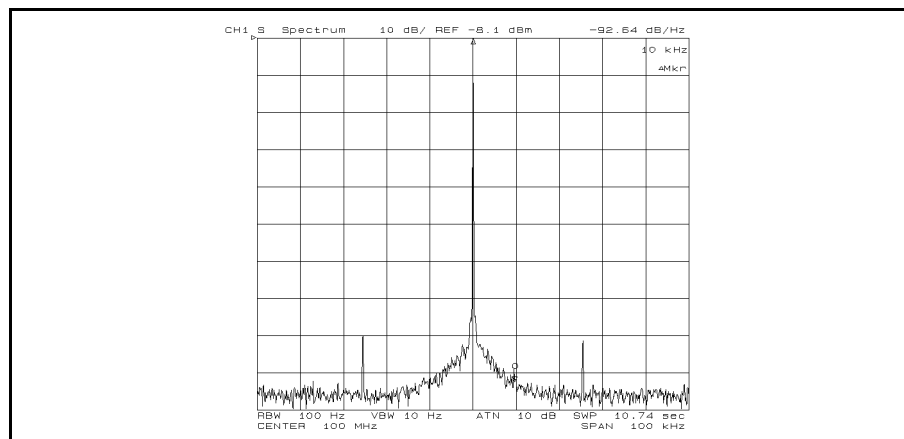

Figure 4-4.
Using Markers and Noise Format to Measure C/N Ratio

- Press **(Marker)** **PRESET MKRS** when you are finished with this measurement.

Tracking a Drifting Signal

When measuring a drifting signal, the analyzer can lose the signal. However, the analyzer can track a drifting signal by changing the sweep parameter values sweep by sweep.

Test Signal The following test signal is used in this example.

- Frequency: 900 MHz (not stable)

Measurement Setup

Connection

Connect the test signal to the S input.

Analyzer Settings

- Press **(Preset)**. Then set the analyzer's controls as follows:

	Desired Settings	Key Strokes
Active Channel Block	Select channel 1	(Chan 1) (default)
Measurement Block	Select Spectrum Analyzer Select S input	Press (Meas) ANALYZER TYPE SPECTRUM ANALYZER (Meas) SPECTRUM:S (default)
Sweep Block	Center frequency 900 MHz Span frequency 20 kHz	Press (Center) 900 (M/μ) Press (Span) 20 (k/m)

- Set channel 2 the same as channel 1 as follows:

	Desired Settings	Key Strokes
Active Channel Block	Select channel 2	(Chan 2)
Measurement Block	Select Spectrum Analyzer Select S input	Press (Meas) ANALYZER TYPE SPECTRUM ANALYZER (Meas) SPECTRUM:S (default)
Sweep Block	Center frequency 900 MHz Span frequency 20 kHz	Press (Center) 900 (M/μ) Press (Span) 20 (k/m)

Tracking an Unstable Signal

In this example, the signal is drifting.

1. Press **Display** **DUAL CHAN** on **OFF** to **ON** off.
2. Press **Chan 1**.
3. Press **Marker** to turn the marker on.
4. Use the knob to bring the marker close to the signal you want to track.
5. Press **Search** **SIGNAL TRK** on **OFF** to turn the signal track on. As the signal drifts, the center frequency automatically changes to bring the signal and the marker to the center of the display.

Figure 4-5 shows a display when signal track is ON at channel 1. Figure 4-6 shows a display after the analyzer sweeps a few times. At channel 1, the center frequency has been changed to maintain the drifting signal at the center of the display. Channel 2 shows that signal frequency has drifted to a higher frequency.

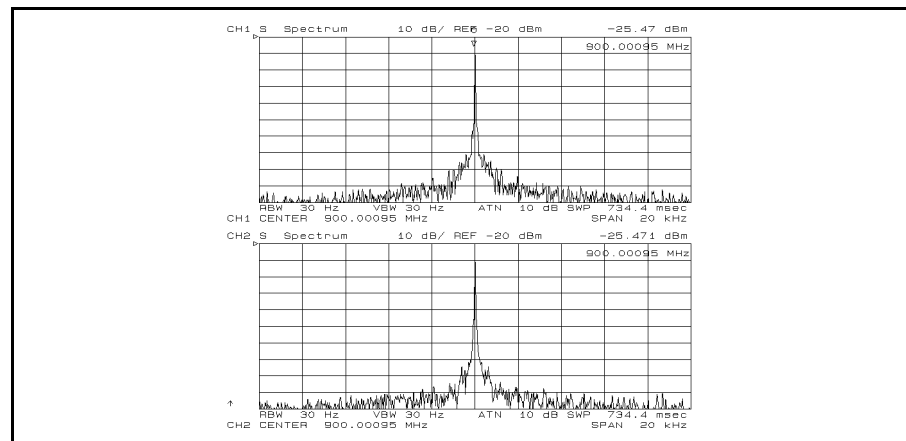

Figure 4-5. Display When Starting Signal Track

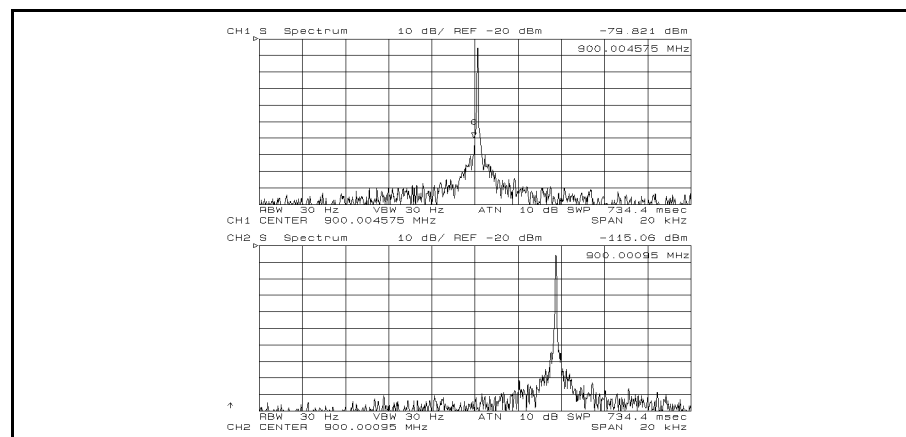

Figure 4-6. Display After Signal Has Drifted

Network Measurement with Spectrum Monitor

During a network measurement, crosstalk or leakage (such as noise) from an adjacent circuit can change the measurement results. To detect the effect of these spurious inputs, the analyzer can monitor the spectrum of the input signal at the R, A, and B inputs.

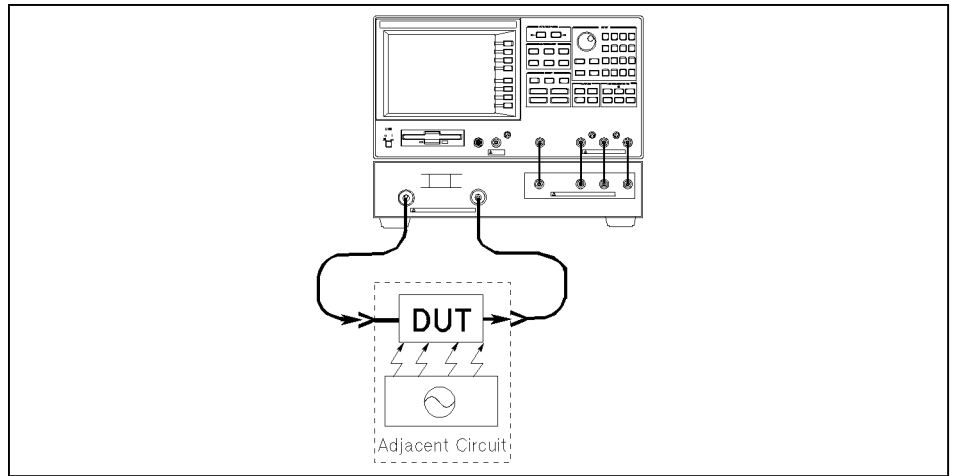

Figure 4-7.
Influence on Network Measurement by Leakage from an Adjacent Circuit

Measurement Setup

In this example, the network measurement circuit has leakage from an adjacent signal source. The frequency of the signal source is 240 MHz and the DUT is a 250 MHz bandpass filter.

Connection

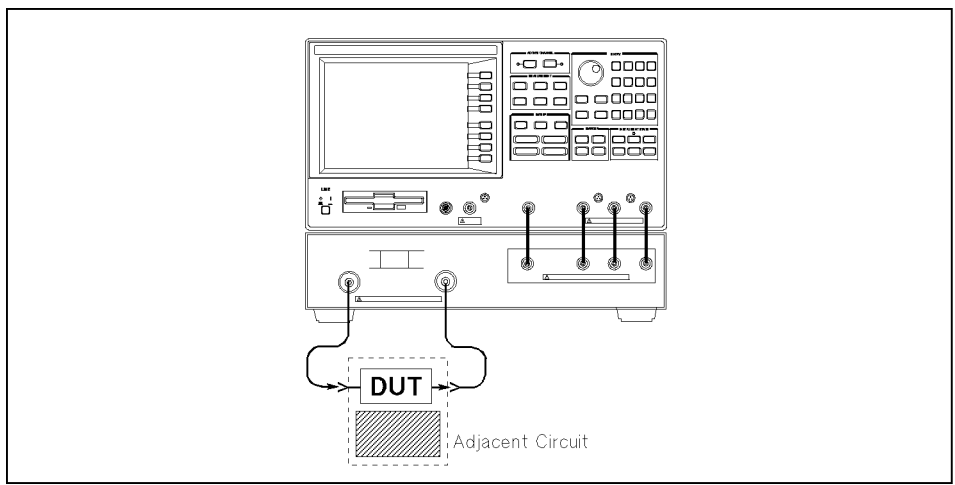

Figure 4-8. Network Measurement With Spectrum Monitor Setup

Analyzer Settings

Press **[Preset]**. Then set the analyzer's controls as follows:

	Desired Settings	Key Strokes
Active Channel Block	Select channel 1	[Chan 1] (default)
Measurement Block	Select Spectrum Analyzer Select S ₂₁ (or B/R) measurement Select LOG MAG format	Press [Meas] ANALYZER TYPE NETWORK ANALYZER [Meas] Trans:FWD S21 [B/R] [Format] LOG MAG (default)
Sweep Block	Center frequency 250 MHz Span frequency 200 MHz	Press [Center] 250 [M/μ] Press [Span] 200 [M/μ]

Performing Calibration

Perform a frequency response calibration for this measurement as follows:

1. Press **[Cal]** CALIBRATE MENU RESPONSE .
2. Connect a THRU calibration standard between the measurement cables in place of the DUT.
3. Press **[THRU]** to perform a frequency response calibration data measurement.
4. Press **[DONE:RESPONSE]** . (**[CORRECTION on OFF]** is automatically set to **[CORRECTION ON off]** .)

Network Measurement

1. Press **[Scale Ref]** AUTO SCALE to fit scale to the trace.
2. Press **[Search]** PEAK to put the marker on an unknown peak of the trace. The transmission measurement result is displayed as shown in Figure 4-9.

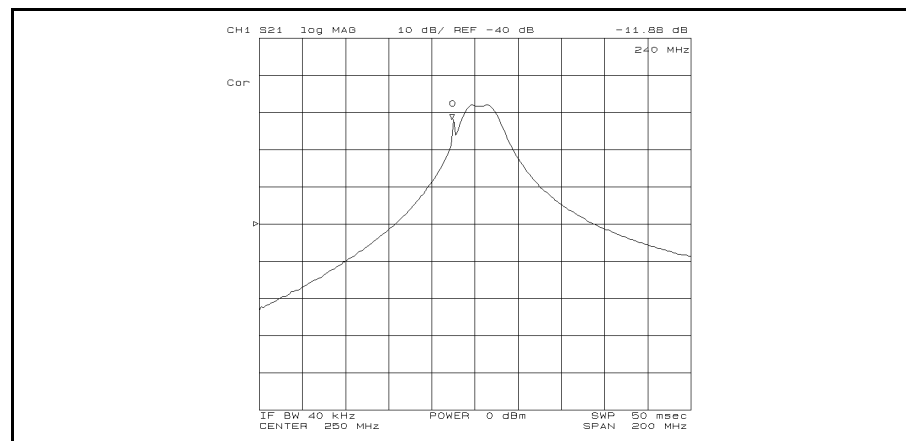

Figure 4-9.
Transmission Measurement Result (Influenced by Leakage)

The measurement result shows an unknown peak at 240 MHz.

Monitoring the Leakage Signal at the B Input Using the Spectrum Monitor

During the spectrum measurement sweep, the network measurement is turned off. To monitor the input signal at the B input:

1. Press **Chan 2**.
2. Press **Meas** **ANALYZER TYPE** **SPECTRUM ANALYZER** **B**.
3. Press **Center** **250** **(M/μ)**.
4. Press **Span** **200** **(M/μ)**.

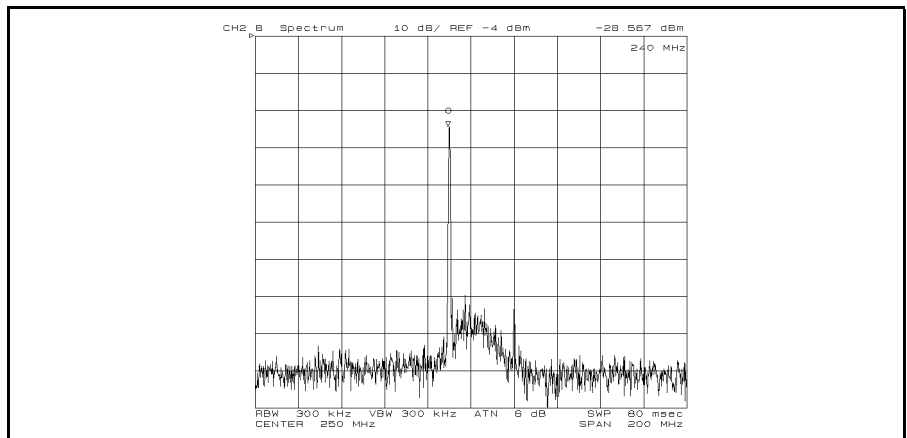

Figure 4-10. Spectrum Monitoring Result at the B Input

The spectrum measurement result shows the leakage signal at 240 MHz.

5. Press **Display** **DUAL CHAN** on **OFF** to **ON** off to perform and display both the network and the spectrum measurements at the same time.

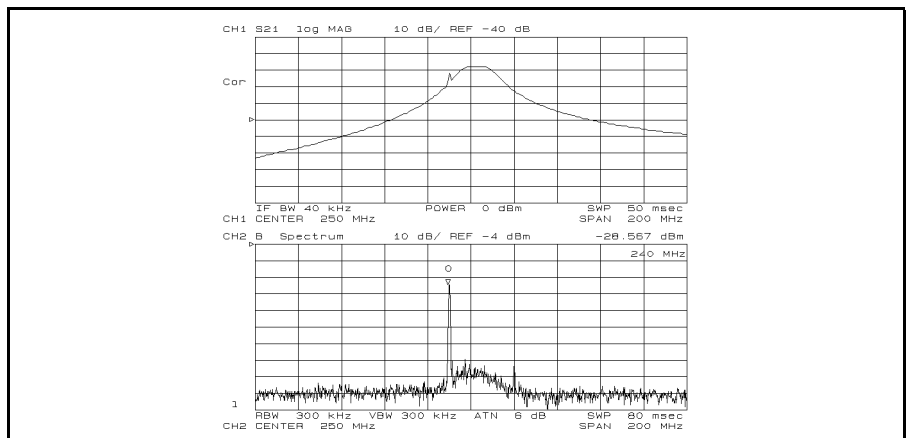

Figure 4-11. Dual Display of Network and Spectrum Measurement

AM Signal Measurement

In this example, the following parameters for AM signal measurement are derived:

- Carrier amplitude (E_c) and frequency (f_c)
- Modulating frequency (f_m) and modulation index (m)

Test Signal The following test signal is used in this example:

- AM Signal
 - Frequency (f_c): 100 MHz
 - Modulating signal frequency (f_m): 10 kHz
 - Modulation index (m): 15%

Measurement Setup

Connection

Connect the test signal source to the S input.

Analyzer Settings

Press **Preset**. Then set the analyzer's controls as follows:

	Desired Settings	Key Strokes
Active Channel Block	Select channel 1	Chan 1 (default)
Measurement Block	Select Spectrum Analyzer Select S input	Press Meas ANALYZER TYPE SPECTRUM ANALYZER Meas SPECTRUM:S (default)
Sweep Block	Center frequency 100 MHz Span frequency 200 kHz	Press Center 100 M/μ Press Span 200 k/m

Carrier Amplitude and Frequency Measurement Using the Marker

Press **Scale Ref** and enter the reference value if the trace needs to be rescaled.

1. Press **Search** to turn the marker on.
2. Press **MAX** to search for the carrier signal. The carrier amplitude and frequency are displayed in the upper right corner as shown in Figure 4-12.

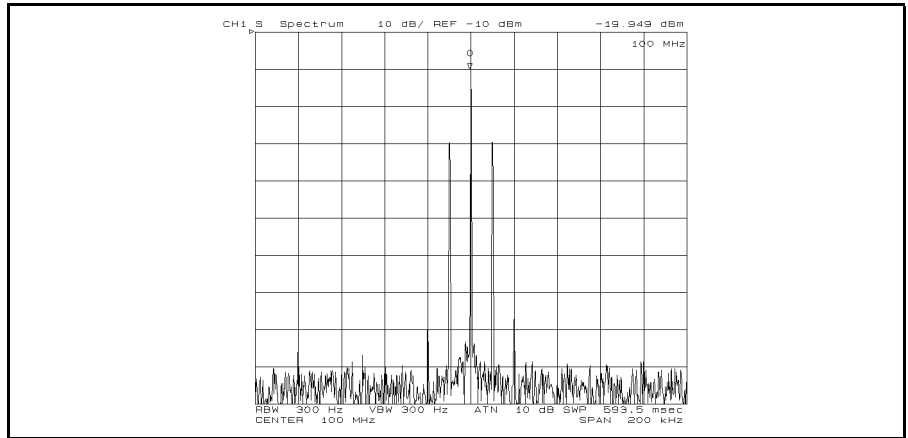

Figure 4-12. Carrier Amplitude and Frequency of AM Signal

The marker shows that the carrier amplitude (E_c) is -19.949 dBm and frequency (f_c) is 100 MHz.

Modulating Frequency and Modulation Index Measurement Using Δ Marker

3. Press **Marker** **ΔMODE MENU** **ΔMKR**.
4. Press **Search** **SEARCH:PEAK** **NEXT PEAK** to search for a sideband. The offset value from the carrier is displayed as the marker sweep parameter value shown in Figure 4-13. This value is the modulation frequency.

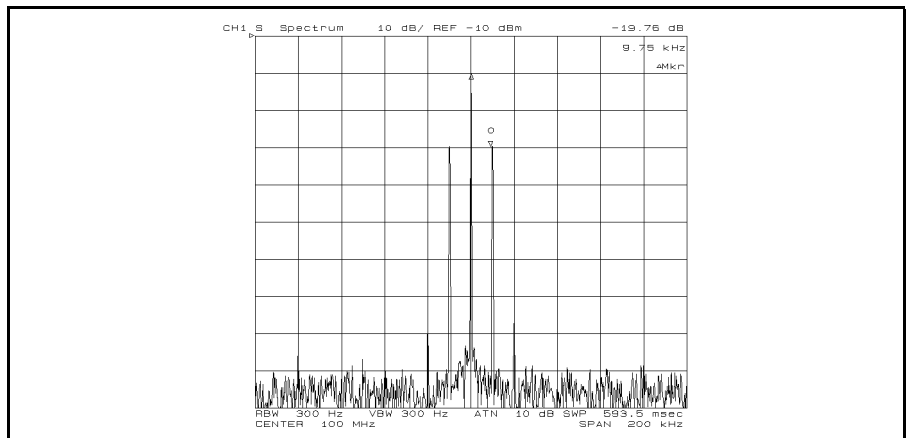

Figure 4-13. Modulating Frequency of AM Signal

The Δ marker shows that the sideband amplitude value relative to the carrier is -19.76 dB. The modulation index (m) can be derived from the following equation:

$$m = 2 \times 10^{-\frac{\Delta Mkr}{20}}$$

$$= 19.45\%$$

where ΔMkr is the Δ marker sweep parameter value shown in Figure 4-13.

FM Signal Measurement

This example describes how to derive the frequency deviation (Δf_{peak}) value.

Test Signal The following test signals are used in this example:

- **Wide band FM Signal**
 - Carrier frequency: 100 MHz.
 - Modulating frequency: 1 kHz.
 - Frequency deviation: 1 MHz.
- **Narrow band FM Signal**
 - Carrier frequency: 100 MHz.
 - Modulating frequency: 1 kHz.
 - Frequency deviation: 5 kHz.

Measurement Setup

Connection

Connect the test signal to the S input.

Analyzer Settings

Press **(Preset)**. Then set the analyzer's controls as follows:

	Desired Settings	Key Strokes
Active Channel Block	Select channel 1	(Chan 1) (default)
Measurement Block	Select Spectrum Analyzer Select S input RBW 1 kHz	Press (Meas) ANALYZER TYPE SPECTRUM ANALYZER (Meas) SPECTRUM:S (default) (Rw/Avg) 1 (k/m)
Sweep Block	Center frequency 100 MHz Span frequency 5 MHz	Press (Center) 100 (M/μ) Press (Span) 5 (M/μ)

Frequency Deviation of Wide Band FM Signal

Press **(Scale Ref)** and enter reference value if the trace needs to be rescaled.

Frequency Deviation

1. Press **(Search)** SEARCH:PEAK.
2. Press **(Marker)** ΔMODE MENU ΔMKR.
3. Press **(Search)** SEARCH:PEAK NEXT PEAK.

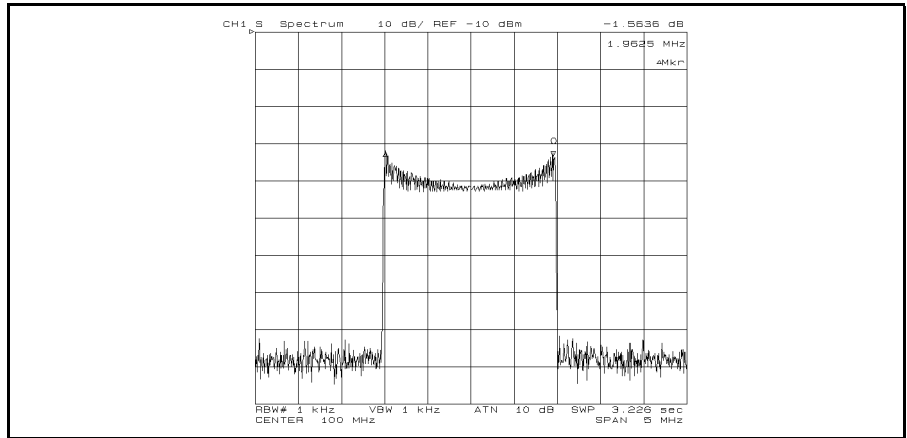

Figure 4-14. Wide Band FM Signal Measurement

The frequency deviation (Δf_{peak}) can be derived from the following equation:

$$\Delta f_{peak} = \frac{|\Delta Mkr|}{2}$$

where ΔMkr is the marker sweep parameter value shown in Figure 4-14. In this example, the frequency deviation is about 981 kHz.

Press **(Marker)** **PRESET MKRS** when you are finished with this measurement.

Carrier Level and Modulating Frequency

The carrier level and modulating frequency can be derived using a method similar to the AM signal measurement. In this example, the zooming function is used to measure the carrier and the adjacent signal.

4. Press **(Display)** **DUAL CHAN on OFF** to **ON off**.
5. Press **(Marker)** to put the maker on the carrier frequency.
6. Press **(Marker→)** **MORE ZOOMING APERTURE 0.2 (X1)**.
7. Press **CROSS CHAN on OFF** to **ON off**.
8. Press **RETURN MKR ZOOM** to zoom up to the carrier signal.
9. Press **(Chan 2)**.
10. Press **(Scale Ref)** and enter reference vale if the trace needs to be rescaled.
11. Press **(Marker)** **100 (M/μ)** to move the marker to the career frequency. The carrier amplitude can be read as the marker value.
12. Press **(Marker)** **ΔMODE MENU ΔMKR** to put the Δmaker on the carrier.
13. Press **(Search)** **SEARCH:PEAK LEFT PEAK** (or **RIGHT PEAK**) to move the marker to the sideband.

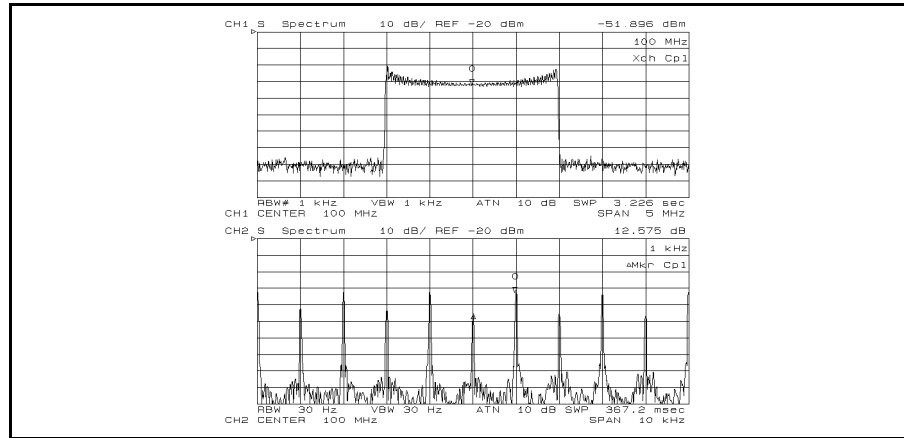

Figure 4-15. Zooming Carrier Signal of FM Signal

Press **[Display]** **DUAL CHAN ON** off to on **OFF** and then **[Chan 1]** when you are finished with this measurement.

Narrow Band FM Signal Measurement

1. Change the test signal source to the narrow band FM signal.
2. Press **[Chan 1]** **[Span]** 100 **[k/m]** **[Bw/Avg]** 10 **[k/m]**. The spectrum of the narrow band FM signal is displayed.
3. Press **[Scale Ref]** -10 **[X1]**.

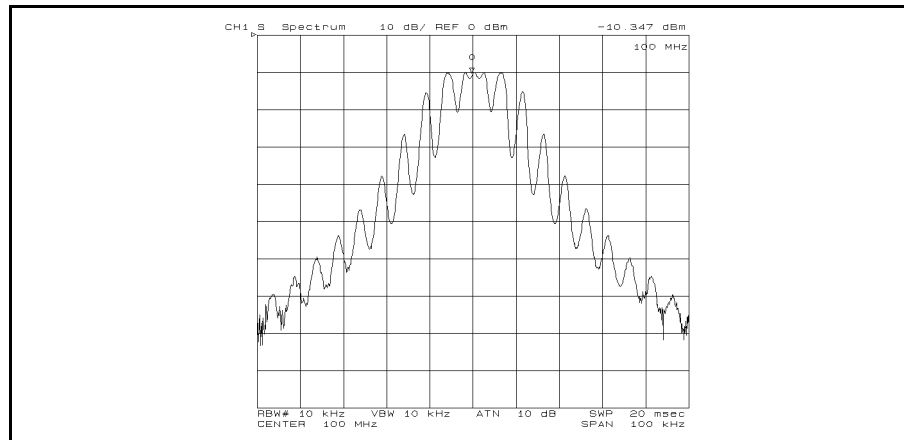

Figure 4-16. Narrow Band FM Signal Measurement

4. Press **[Chan 2]** **[Span]** 100 **[k/m]** **[Bw/Avg]** 10 **[k/m]** **[Scale Ref]** -10 **[X1]** as same as channel 1.
5. Press **[Display]** **DATA HOLD** **[OFF]** **MAX** and then wait for a few sweeps until the trace is stable. The maximum envelope is displayed.
6. Press **[Display]** **DATA→MEMORY** **DATA** and **MEMORY** to store and display the maximum envelope.

7. Press **DATA HOLD** **[MAX]** **MIN** and then wait for a few sweeps until the trace is stable. The minimum envelope is displayed.
8. Press **(Marker)** **MKR ON** **[DATA]** to **[MEMORY]** . Then turn the knob to move the marker to the desired position to measure the frequency deviation.
9. Press **ΔMODE MENU** **FIXED ΔMKR** .
10. Press **RETURN** **MKR ON** **[MEMORY]** to **[DATA]** . Then turn the knob to move the marker to the position that is the same value as the fixed Δmarker value.

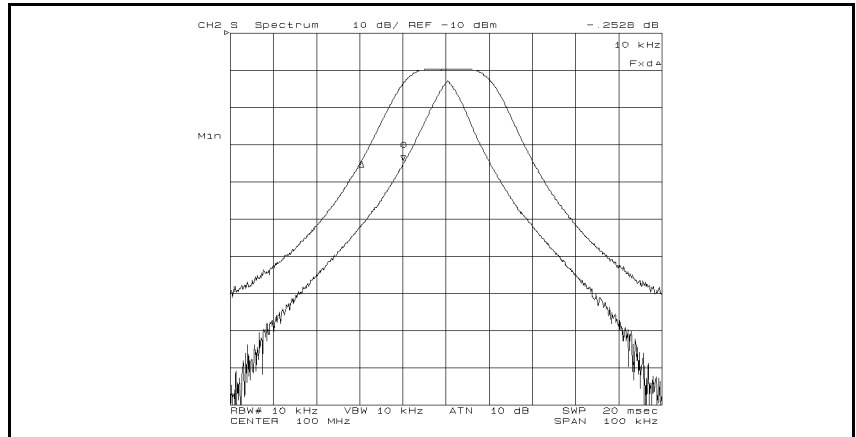

Figure 4-17.

Maximum and Minimum Envelopes of Narrow Band FM Signal

The frequency deviation (Δf_{peak}) can be derived from the same equation that is used for the wide band FM signal. In this example, Δf_{peak} can be derived to be 5 kHz.

11. Press **(Display)** **DUAL CHAN** on **OFF** to **ON** off . Both the spectrum and its envelope are displayed on the split display.
12. Press **MORE** **SPLIT DISP** **ON** off to on **OFF** . The analyzer superimposes the spectrum on the envelopes as shown in Figure 4-18.

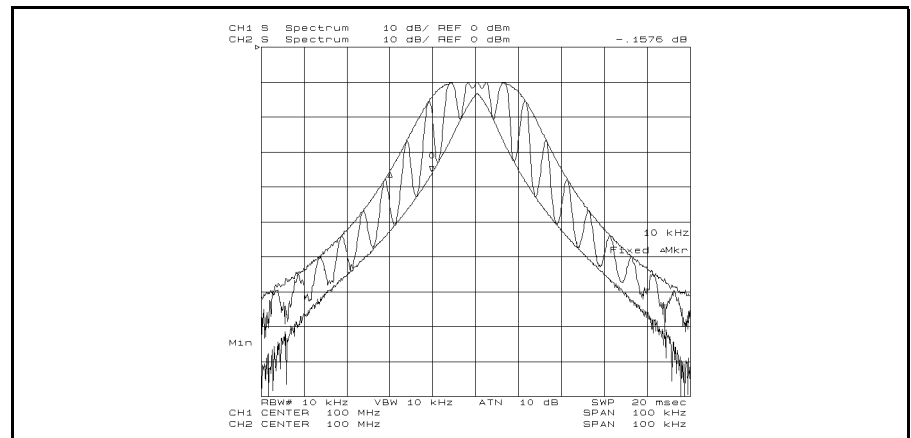

Figure 4-18. Superimposing Spectrum and Envelopes

Burst Signal Measurement

This measurement requires that option 1D6 be installed in the analyzer. A summary of how to determine gate delay and gate length settings for different signals is contained at the end of this example.

Test Signal The following test signal is used in this example:

- Pulse period (PRI) = 100 μ s (pulse repetition frequency PRF is 10 kHz)
- Duty ratio is 80% (pulse width τ is 80 μ s)
- RF frequency is 960 MHz

Measurement Setup

Connection

Setup the analyzer as shown in Figure 4-19.

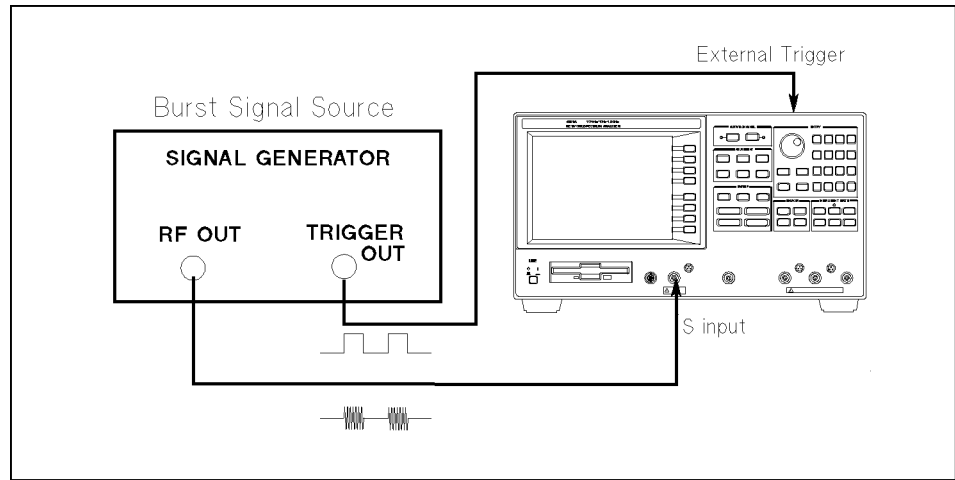

Figure 4-19. Burst Signal Measurement Setup

Analyzer Settings

Press **[Preset]**. Then set the analyzer's controls as follows:

	Desired Settings	Key Strokes
Active Channel Block	Select channel 1	[Chan 1] (default)
Measurement Block	Select Spectrum Analyzer	Press [Meas] ANALYZER TYPE SPECTRUM ANALYZER
	Select S input	[Meas] SPECTRUM:S (default)
	Set RBW to 100 kHz	Press [Bw/Avg] 100 [k/m]
Sweep Block	Center frequency 960 MHz	Press [Center] 960 [M/μ]
	Span frequency 10 MHz	Press [Span] 10 [M/μ]

Gated Sweep for Burst Signal Measurement

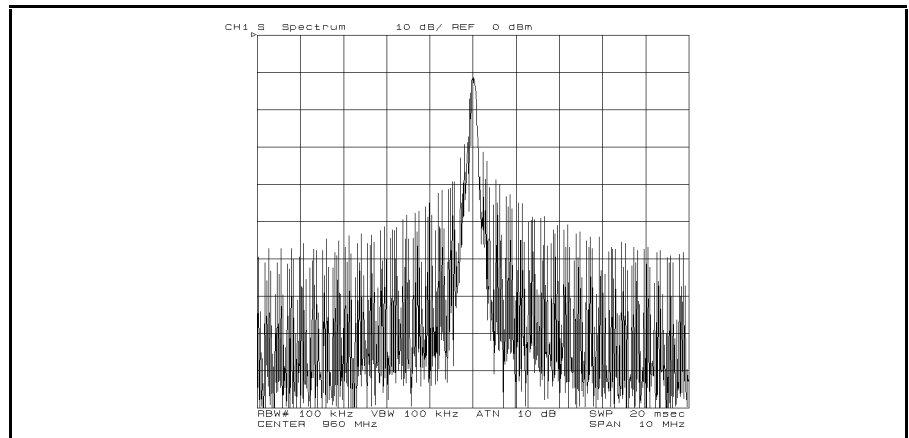

Figure 4-20.
Burst Signal Measurement Result Using Normal Sweep

1. Press **Trigger** **TRIGGER: [FREE RUN] GATE [LEVEL] EDGE** to select the trigger mode to the edge mode.
2. Press **GATE DELAY 30 (M/μ)** for setup time of the RBW.
3. Press **GATE LENGTH 30 (M/μ)**. The analyzer displays only the RF signal spectrum as shown in Figure 4-21.

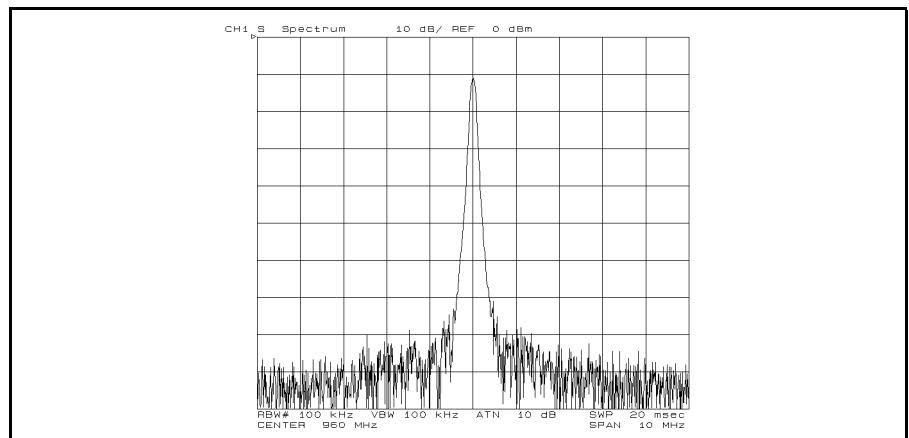

Figure 4-21. Burst Signal Measurement Using Gated Sweep

Zero Span for Time Domain Measurement

Using zero span, the analyzer can show the envelope of the burst signal. The repetitive sampling mode can sample a faster signal.

1. Press **Trigger** **SWEEP:HOLD** to keep the channel 1 trace.
2. Press **Display** **DUAL CHAN on OFF** to **ON off**.
3. Press **Chan 2**.

4. Press **[Meas]** ANALYZER TYPE SPECTRUM ANALYZER .
5. Press **[SPAN]** ZERO SPAN .
6. Press TRIGGER: [GATE] EXTERNAL .
7. Press **[SWEEP]** SAMPLING NORM rept to norm REPT to change the sampling mode to the repetitive sampling mode.
8. Press NUMBER of POINTS 101 **[X1]**. Then press SWEEP TIME 550 **[M/μ]**.

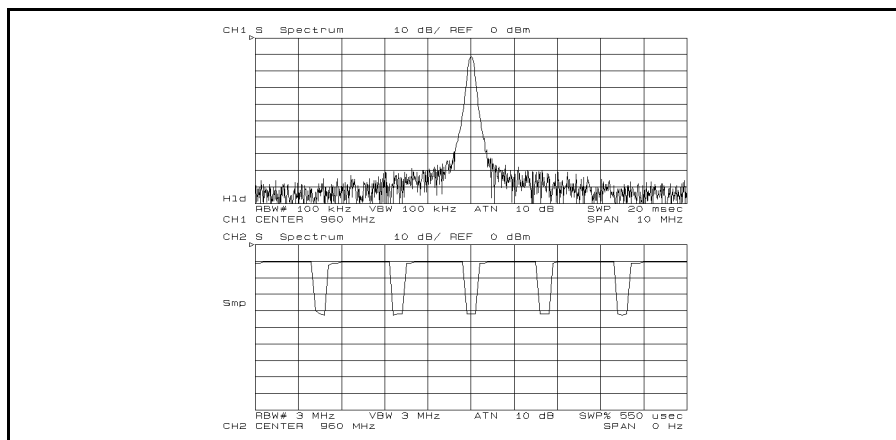

Figure 4-22. Burst Signal Spectrum and Test Signal Envelope

How to Determine Gate Delay and Gate Length

Gate Delay

Because the RBW filter requires setup time for the filter to stabilize after triggering, the gate delay must meet the following limit:

$$T_d > \frac{2}{RBW}$$

In this example, RBW = 100 kHz,

$$T_d > \frac{2}{100 \times 10^3} = 20 \mu$$

therefore, the delay time T_d in this example must meet the following condition:

$$T_d > 20 \mu$$

Gate Length

Because the summation of gate delay T_d and the gate length T_g must be less than the pulse length (τ), the gate length must meet the following limit:

$$T_d + T_g < \tau$$

In this example, $\tau = 80 \mu$,

$$T_g < 80 \mu - T_d$$

If T_d is set to 30μ in this example, T_g must meet the following limit:

$$T_g < 50 \mu$$

For more information on the gated sweep and the repetitive sampling mode, see the *Function Reference* manual.

Network Measurement Examples

This chapter contains the following network measurement examples:

- Transmission Measurement
 - 3 dB bandwidth
 - Ripple or flatness
 - Magnitude and phase characteristics
 - Expanded phase characteristics
- Electrical length measurement
- Phase distortion measurement
 - Deviation from linear phase
 - Group delay
- Reflection measurement
 - Return loss
 - Reflection coefficient
 - Standing wave ration (SWR)
- S-parameters measurement
- Impedance and admittance measurement
- List sweep
 - Sweep time reduction
 - Dynamic range enhancement
- Filter testing using limit line
- Gain compression measurement

Basic Setup

All the examples described in this chapter use the 85046A/B S-parameter Test Set to connect to the device under test (DUT). This approach simplifies the measurement setup.

Example DUT

The DUT used in the examples in this chapter is a dielectric bandpass filter with a 836 MHz center frequency. If you use your own DUT, modify the parameter values (measurement frequency range, signal level, etc.) as appropriate for your DUT.

Measuring Transmission Characteristics of a Filter

Insertion loss and gain are ratios of the output to input signals. The following procedure measures the insertion loss and gain of a 836 MHz dielectric bandpass filter. This measurement can be used to obtain the key filter parameters.

Measurement Setup

Connection

Set up the analyzer as shown in Figure 5-1.

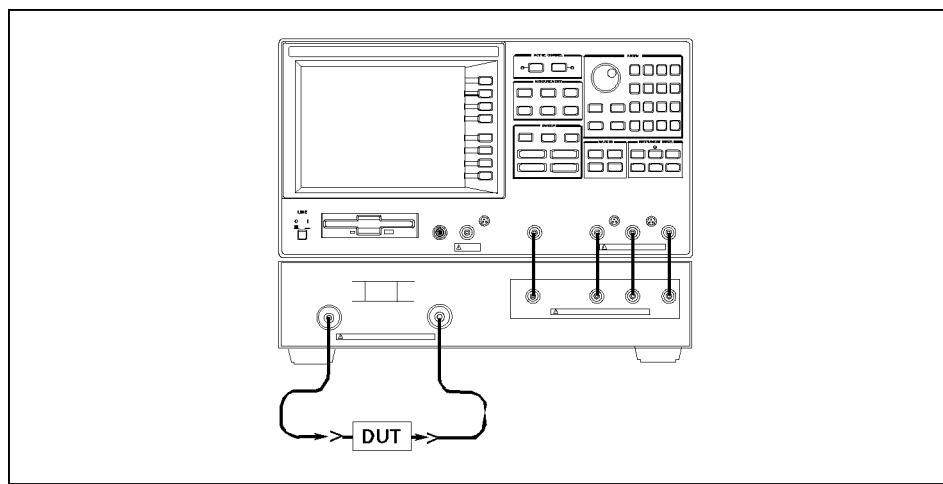

Figure 5-1. Transmission Measurement Setup

Analyzer Settings

Press **[Preset]**. Then set the analyzer's controls as follows:

	Desired Settings	Key Strokes
Active Channel Block	Select channel 1	[Chan 1] (default)
Measurement block	Select Network Analyzer	Press [Meas] ANALYZER TYPE NETWORK ANALYZER
	Select S_{21} (or B/R) measurement	Press [Meas] Trans:FWD S21 [B/R]
	Select LOG MAG format	[Format] LOG MAG (default)
	IF BW 3 kHz	[Bw/Avg] 3 [k/m]
Sweep block	Center frequency 836 MHz	Press [Center] 836 [M/μ]
	Span frequency 200 MHz	Press [Span] 200 [M/μ]

Performing Calibration

Perform a frequency response calibration for this measurement as follows:

1. Press **[Cal]** **CALIBRATE MENU RESPONSE**.

2. Connect a THRU calibration standard between the measurement cables in place of the DUT.
3. Press **THRU** to perform a frequency response calibration data measurement.
4. Press **DONE:RESPONSE**. (**CORRECTION on OFF** is automatically set to **CORRECTION ON off**.)

Measurement

Replace the THRU standard with the DUT. Press **Scale Ref** **AUTO SCALE** if the trace needs to be rescaled. Note that the display shows the complete response of the bandpass filter under test.

Read Out Insertion Loss Using the Marker

1. Press **Search** **MAX** to move the marker to the maximum value of trace. The marker reads out the insertion loss and displays it at the upper right of the display.
2. Press **Marker** **ΔMARKER MENU** **ΔMKR** to turn on the ΔMarker (at the position of the marker).
3. Enter 60 **(M/μ)** to move the marker to the point offset from the Δmarker. The Δmarker value shows the out-of-band rejection.

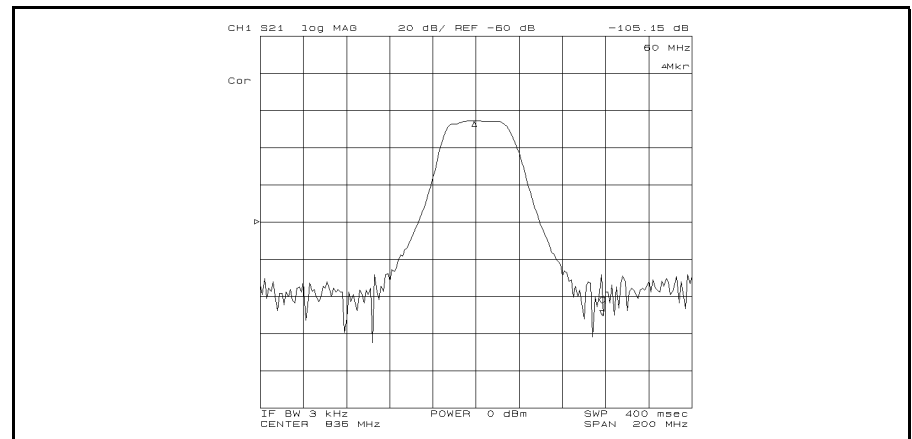

Figure 5-2. Response of a Dielectric Filter

3 dB Bandwidth

The analyzer calculates the bandwidth of the DUT between two equal power levels. In this example, it calculates the -3 dB bandwidth relative to the filter center frequency.

1. Press **Marker**. Then use the rotary knob to move the marker to the center of the filter passband.
2. Press **Search** **WIDTH [OFF]** **WIDTH on OFF to ON off**. The analyzer calculates the -3 dB bandwidth, center frequency, Q (Quality Factor), insertion loss, and differences between the center frequency and the cutoff frequencies of the DUT. It then lists the results at the upper right hand of the display. Sub-marker 1 on the trace shows the passband center frequency and sub-markers 2 and 3 show the location of the -3 dB cutoff points.

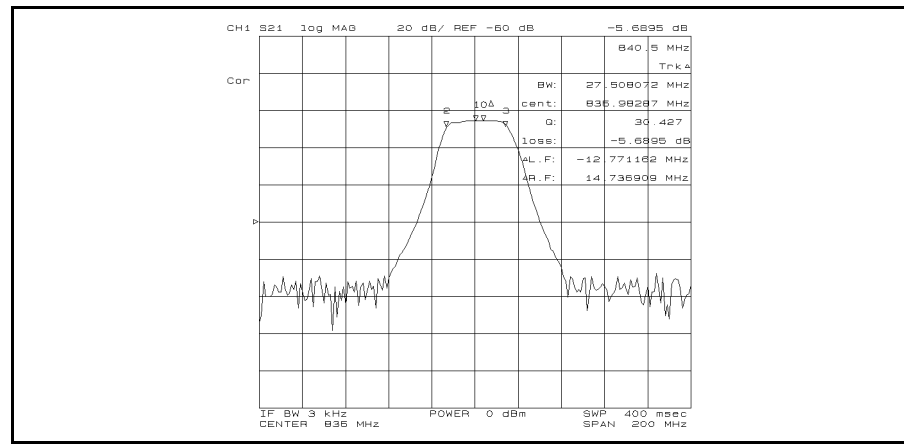

Figure 5-3. Using the Marker to Determine 3 dB Bandwidth

To have the analyzer calculate the bandwidth between other power levels, select **WIDTH VALUE** and enter the number (for example, enter -6 **[x1]** for -6 dB).

Press **Marker** **PRESET MKRS** when you are finished with this measurement.

Ripple or Flatness

Passband ripple (or flatness) is the variation in insertion loss over a specified portion of the passband.

1. Press **(Display)** DUAL CHAN on OFF to ON off to display channel 2 below channel 1.
2. Press **(Sweep)** COUPLED CH ON off to on OFF.
3. Press **(Search)** MAX.
4. Press **(Marker→)** CROSS CHAN on OFF to ON off.
5. Press **MORE** ZOOMING APERTURE 20 **(X1)** RETURN MKR ZOOM.
6. Press **(Chan 2)** **(Search)** MAX. Then press **(Scale Ref)** MKR→REFERENCE SCALE/DEV 0.5 **(X)** to magnify the trace to resolve the ripple.
7. Press **(Search)** SEARCH:PEAK. Then press **(Marker)** ΔMODE MENU ΔMKR.
8. Press **(Search)** SEARCH:PEAK PEAK DEF MENU PEAK PLRTY POS neg to pos NEG RETURN. Then press **(Search)** SEARCH:PEAK. The passband ripple is automatically given as the peak-to-peak variation between the markers. The ripple value is displayed at the upper right of the display.

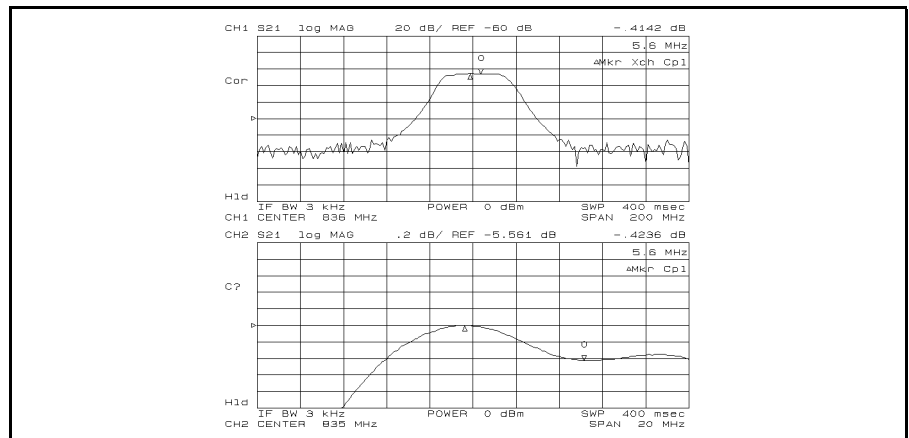

Figure 5-4. Using Peak Search to Determine Ripple

Press **(Chan 1)** **(Marker)** PRESET MKRS, and **(Chan 2)** **(Marker)** PRESET MKRS when you are finished with this measurement.

Measuring Phase Response

A two input ratio measurement can also provide information about the phase shift of a network. The analyzer can translate this information into a related parameter, group delay.

With the same connection, instrument settings, and calibration used in the previous example (see “Measurement Setup” in “Measuring Transmission Characteristics of a Filter”), make the following changes:

1. Press **Chan 1** **Sweep** **COUPLED CH on OFF** to **ON off** to couple sweep parameters of channel 2 to channel 1.
2. Press **Chan 2** **Format** **PHASE** to display the phase response on channel 2.

If the trace needs to be rescaled, press **Scale Ref** and **AUTO SCALE**.

Figure 5-5 shows the phase response of the bandpass filter. Notice the linear phase shift through the passband and the rapid fluctuations that occur outside this region. The random phase of the broadband noise floor causes the spurious out-of-band response.

This format displays phase over the range of -180 to $+180$ degrees. As phase increases beyond these values, a sharp 360 degree transition occurs in the display as the trace “wraps” between $+180$ and -180 degrees. This wrap causes the characteristic “sawtooth” display usually seen on devices with linearly increasing (or decreasing) phase responses.

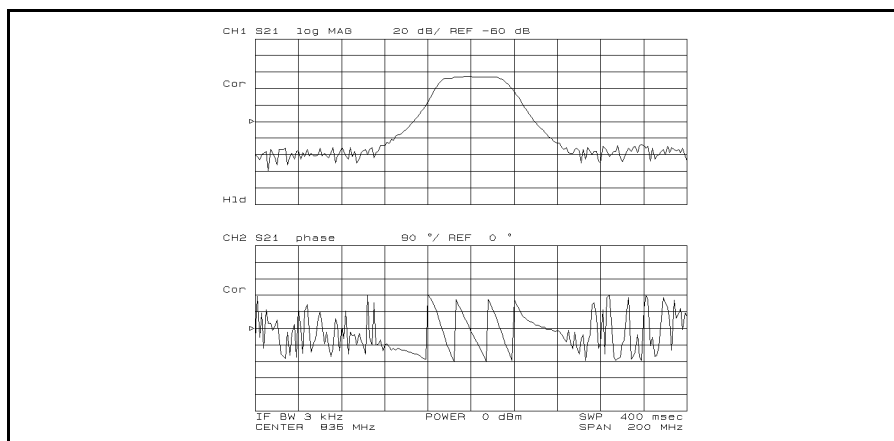

Figure 5-5. Amplitude and Phase Response of a Dielectric Filter

Using the Expanded Phase Mode

The analyzer can display phase beyond ± 180 degrees. Press **Format** **MORE EXPANDED PHASE**. Then press **Scale Ref** **AUTO SCALE**. The phase is displayed with “no wrap” (see Figure 5-6).

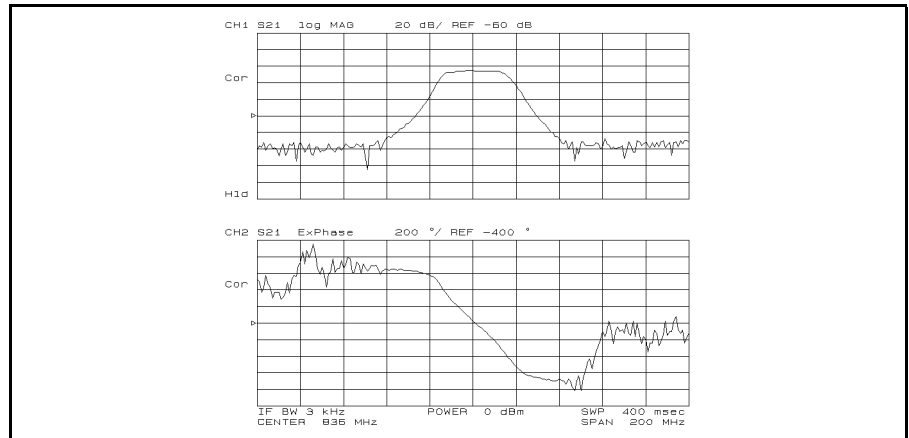

Figure 5-6. Expanded Phase Mode

Press **Format** **PHASE** when you are finished with this measurement.

Measuring Electrical Length

The analyzer electronically implements a function similar to the mechanical “line stretchers” of earlier analyzers. The analyzer’s electrical length correction function simulates a variable length lossless transmission line. This simulated line can be added or removed from a receiver’s input to compensate for interconnecting cables or other connections. In this example, this function is used to measure the electrical length of a test device.

Measurement Setup

With the same connection, instrument settings, and calibration used in the previous example (see “Measurement Setup” in “Measuring Transmission Characteristics of a Filter”), make the following changes:

1. Press **Chan 1** **Format** **PHASE** to display the phase trace on channel 1.
2. Press **Display** **DUAL CHAN ON** off to on **OFF**.
3. Press **Span** 50 **(M/μ)** to zoom the passband trace on the display.

Measurement

If the trace needs to be rescaled, press **Scale Ref** **AUTO SCALE**.

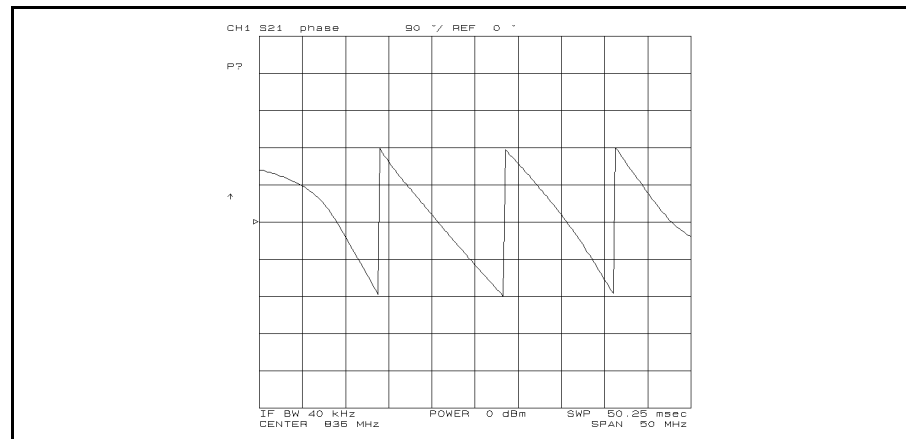

Figure 5-7.
Phase Response of a Dielectric Filter Over a 50 MHz Span

Electrical Length Adjustment

The linearly decreasing phase is due to the DUT’s electrical length. This length is measured by electronically adding length to the R input to compensate for it.

1. Press **Chan 2** to activate channel 2.
2. Press **Marker**. Then move the marker to any of the points where the sloping trace crosses the center. Place the marker on the sloping portion of the trace, not on the vertical phase “wrap-around.”

3. Press **[Scale Ref]** **ELEC DELAY MENU** **MARKER—DELAY**. The analyzer adds enough electrical length to match the group delay present at the marker frequency (group delay is discussed in the next measurement example).
4. Press **[Display]** **DUAL CHAN** on **OFF** to **ON** off to display the results before and after the adjustment. The results are shown in Figure 5-8.
5. To display the amount of electrical length added, press **[Scale Ref]** **ELEC DELAY MENU** **ELECTRICAL DELAY**.

You can also determine the electrical length by pressing **[Scale Ref]** **ELEC DELAY MENU** **ELECTRICAL DELAY**. Then turn the rotary knob until the displayed trace is flat (see Figure 5-8). It may take many revolutions of the knob before the trace is flat.

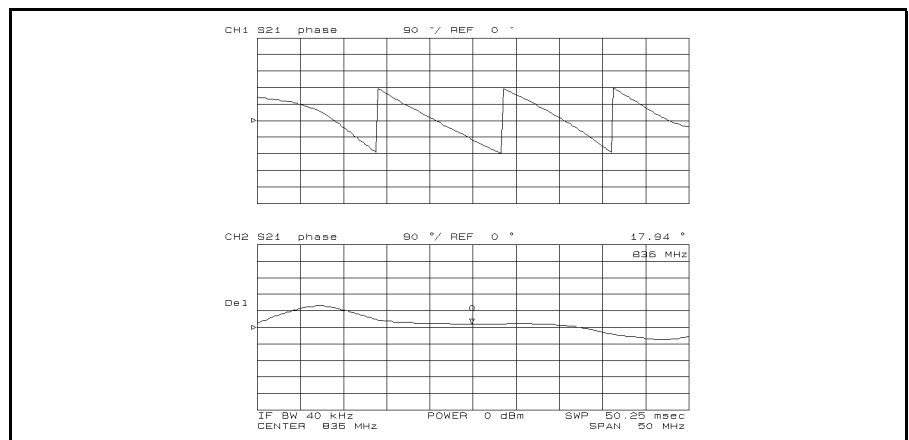

Figure 5-8. Electrical Length Adjustment

Measuring Phase Distortion

For many networks, the amount of insertion phase is not nearly as important as the linearity of the phase shift over a range of frequencies. The analyzer can measure this linearity and express it in two different ways:

- Directly (as deviation from linear phase).
- As group delay (a derived value).

Measurement Setup

This example assumes the measurement settings made in “Measuring Electrical Length” (the previous example) are still in effect.

Deviation from Linear Phase

By adding electrical length required to flatten the phase response, you have already removed the linear phase shift caused by the DUT. The remaining response is the deviation from linear phase.

Press **Display** **DUAL CHAN ON** **off** to **on OFF**.

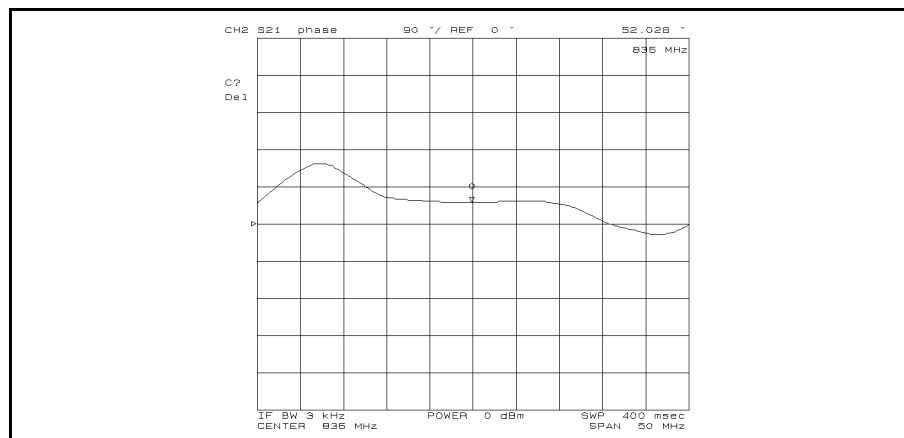

Figure 5-9. Deviation From Linear Phase

Press **Scale Ref** **ELEC DELAY MENU** **ELECTRICAL DELAY** **0** **(X1)** when you are finished with this measurement.

Group Delay Measurement

The phase linearity of many devices is specified in terms of group delay or envelope delay. This is especially true of telecommunications components and systems.

Group delay is the difference in propagation time through a device as a function of frequency. It is measured as a ratio of phase change over a sample delta frequency as follows:

$$\text{Group Delay} = -\frac{\Delta\phi}{360\Delta F}$$

Where: $\Delta\phi$ is phase change [deg]

ΔF (commonly called the “aperture”) is the frequency difference that gives $\Delta\phi$

To display group delay, press **[Format] DELAY**. If the trace needs to be rescaled, press **[Scale Ref]** and **AUTO SCALE**. The default aperture is very narrow, so the group delay measurement displayed is very noisy.

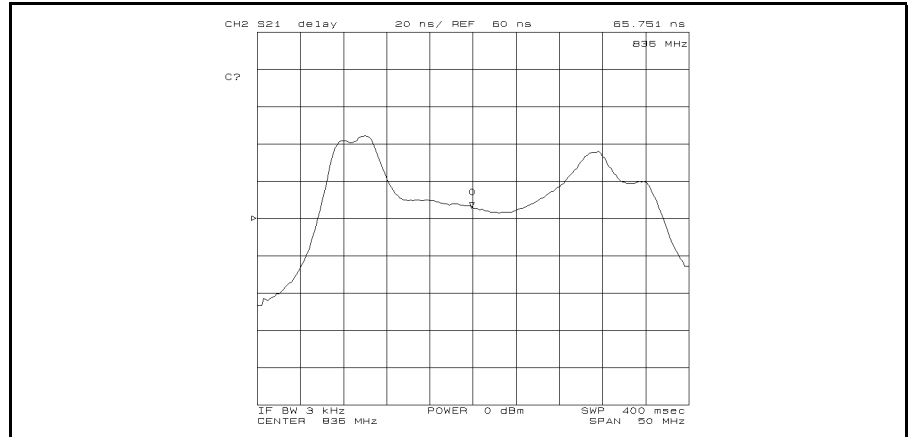

Figure 5-10. Group Delay

Smoothing Group Delay Trace

By setting a wide aperture, rapid changes in phase are averaged and have less effect on the measurement. However, some loss in measurement detail occurs with wide apertures. Press **[Bw/Avg]** **GROUP DELAY APERTURE**. The value of the aperture is shown at the upper left of the display. Press **[↑]** to increase the aperture (the display becomes less noisy).

Where to Find More Information

For more information on group delay principles, see the *Task Reference* manual.

Reflection Measurement

When making a reflection measurement, the analyzer monitors the signal going to the DUT and uses it as the reference. It compares the reflected signal from the DUT to the reference signal. The ratio of the incident and reflected signals is the reflection coefficient of the DUT or, when expressed in decibels, the return loss.

Reflection measurements require the connection of a directional device, such as a directional coupler, to separate the power reflected from the DUT. This separation is necessary so that it can be measured independently of the incident power (see the following figure).

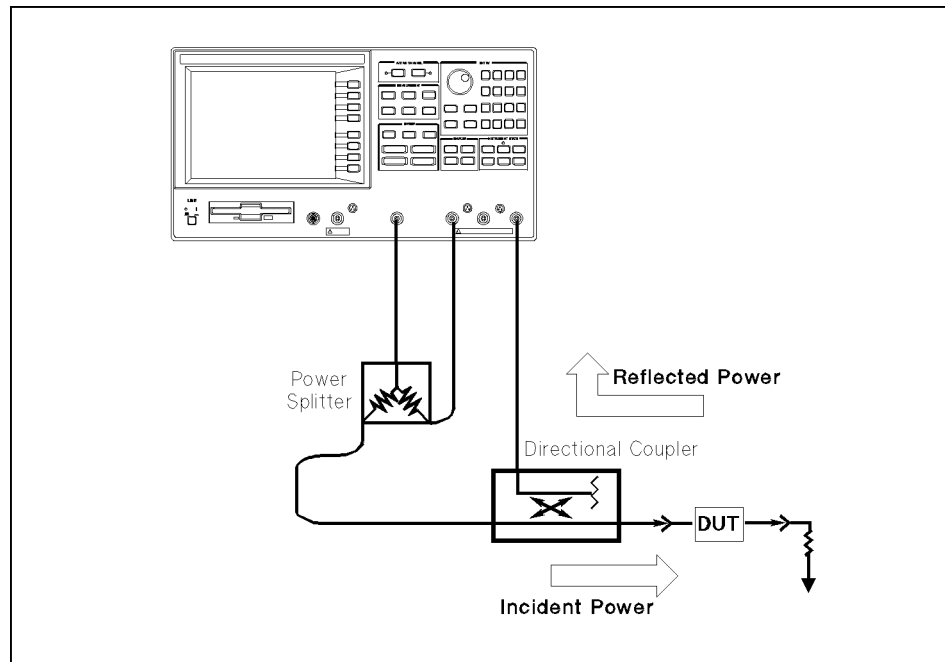

Figure 5-11. Reflection Measurement

Multi-Port Test Devices

When the device has more than one port, connect high-quality terminations (loads) to all unused DUT ports to terminate them into their characteristic impedance (usually 50 or 75 Ω). If this is not done, reflections off the unused ports will cause measurement errors.

The S-parameter test set automatically switches the termination at the unused port for each S-parameter measurement. When using a transmission/reflection test set, terminate the unused input port of the analyzer with a high quality load.

The signal reflected from the DUT is measured as a ratio with the incident signal. It can be expressed as a reflection coefficient, a return loss, or as SWR. These measurements are mathematically defined as:

$$\text{return loss(dB)} = -20 \log(\rho)$$

$$\begin{aligned} \text{reflection coefficient} &= \frac{\text{reflected power}}{\text{incident power}} \\ &= \rho \text{ (magnitude only)} \\ &= \Gamma \text{ (magnitude and phase)} \\ &= S_{11} \text{ or } S_{22} \text{ (magnitude and phase)} \end{aligned}$$

$$\text{SWR} = \frac{1 + \rho}{1 - \rho}$$

Measurement Setup

Connection

Set up the analyzer as shown in Figure 5-12.

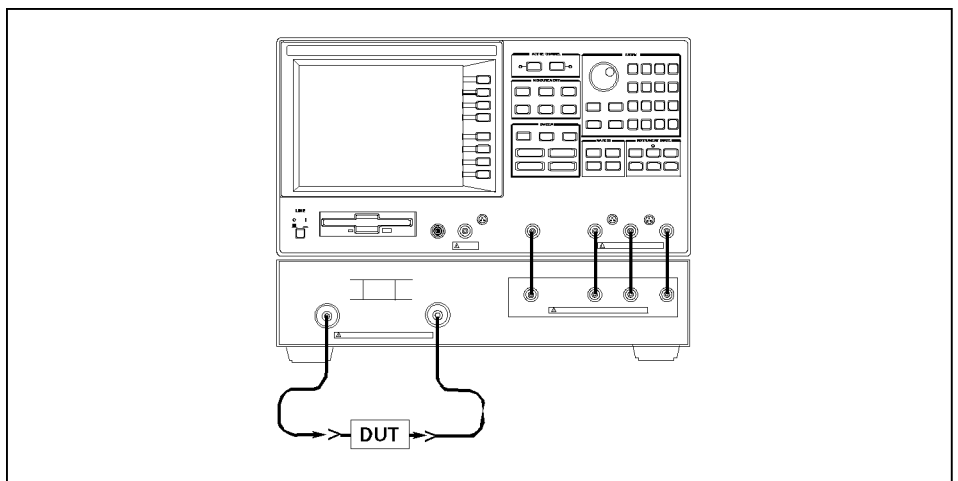

Figure 5-12. Reflection Measurement Setup

Analyzer Settings

Press **[Preset]**. Then set the analyzer's controls as follows:

	Desired Setting	Key Strokes
Active Channel Block	Select channel 1	Press [Chan 1] (default)
Measurement Block	Select network analyzer	Press [Meas] ANALYZER TYPE NETWORK ANALYZER
	Select S_{11}	Press [Meas] Ref1:FWD S11 [A/R] (default)
	Select LOG MAG format	Press [Format] LOG MAG (default)
Sweep block	Center frequency 836 MHz	Press [Center] 836 [M/μ]
	Span frequency 100 MHz	Press [Span] 100 [M/μ]

Performing Calibration

Perform an S_{11} , 1-port calibration for this measurement. The following procedure is for using 7 mm standards (see the *Task Reference* manual for using other standard devices).

1. Press **Cal** **CALIBRATE MENU** **S11 1-PORT**.
2. Connect the OPEN standard to port 1. Then press **(S11):OPEN**. (The softkey label **OPEN** is underlined when the measurement is completed.)
3. Connect the SHORT standard to port 1. Then press **SHORT**. (The softkey label **SHORT** is underlined when the measurement is completed.)
4. Connect the LOAD standard to port 1. Then press **LOAD**. (The softkey label **LOAD** is underlined when the measurement is completed.)
5. Press **DONE:1-PORT CAL**. (**CORRECTION** on **OFF** is automatically set to **ON off**.)

Note



The next example “S-Parameters Measurement” uses the calibration corrections you just completed. Do not change the calibration settings before doing the example.

Measurement

Connect the DUT to the test set. Press **Scale Ref** **AUTO SCALE** if the trace needs to be rescaled.

Return Loss and Reflection Coefficient

The return loss characteristics are displayed in the Log Mag format in Figure 5-13. The value inside the passband is greater than outside the passband. A large value for return loss corresponds to a small reflected signal just as a large value for insertion loss corresponds to a small transmitted signal.

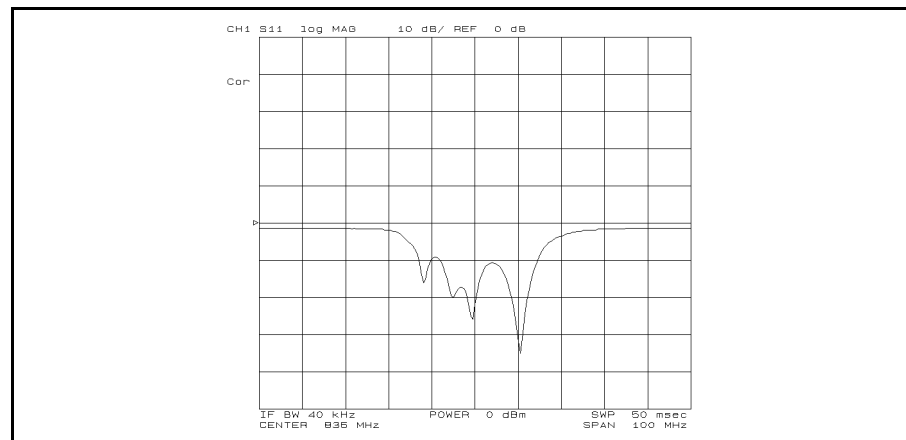

Figure 5-13. Return Loss

To display the same data in terms of reflection coefficient, press **Format** **LIN MAG**. This redisplay the existing measurement in a linear

magnitude format that varies from $\Gamma=1.00$ at the top of the display (100% reflection) to 0.00 at the bottom of the display (perfect match).

Standing Wave Ratio

To display the reflection measurement data as standing wave ratio (SWR), press **Format** **SWR**. The analyzer reformats the display in the unitless measure of SWR (with SWR = 1, a perfect match, at the bottom of the display).

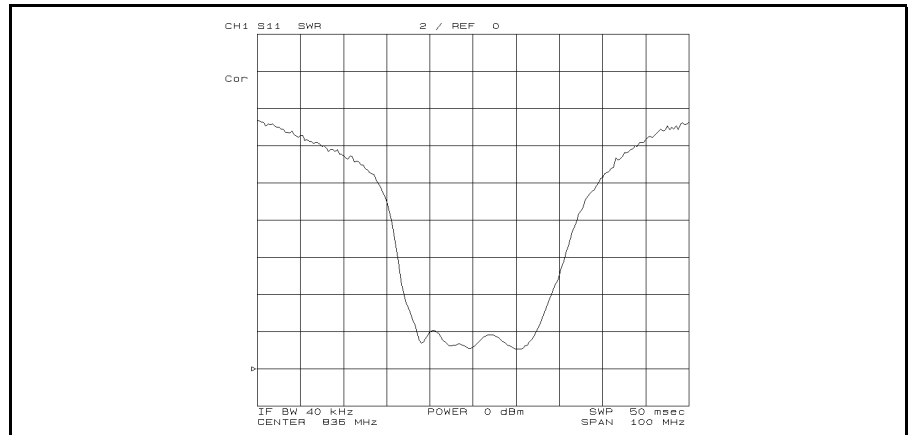

Figure 5-14. SWR

S-Parameters Measurement

S-parameters S_{11} and S_{22} are no different from the measurements made in the previous section. S_{11} is the complex reflection coefficient of the DUT's input. S_{22} is the complex reflection coefficient of the DUT's output. In both cases, all unused ports must be properly terminated.

To display the trace on the polar chart, press **Format** **POLAR**.

The results of a typical S_{11} measurement is shown in Figure 5-15. Each point on the polar trace corresponds to a particular value of both magnitude and phase.

Polar Chart Shows Magnitude and Phase	
■ Magnitude	
□	The center of the circle represents a reflection coefficient Γ of 0, that is, a perfect match or no reflected signal.
□	The outermost circumference of the scale represents a $\Gamma = 1.00$, or 100 % reflection.
■ Phase	
□	The 3 o'clock position corresponds to zero phase angle, that is, the reflected signal is at the same phase as the incident signal.
□	Phase differences of 90, 180, and 270 degrees correspond to the 12, 9, and 6 o'clock positions on the polar display, respectively.

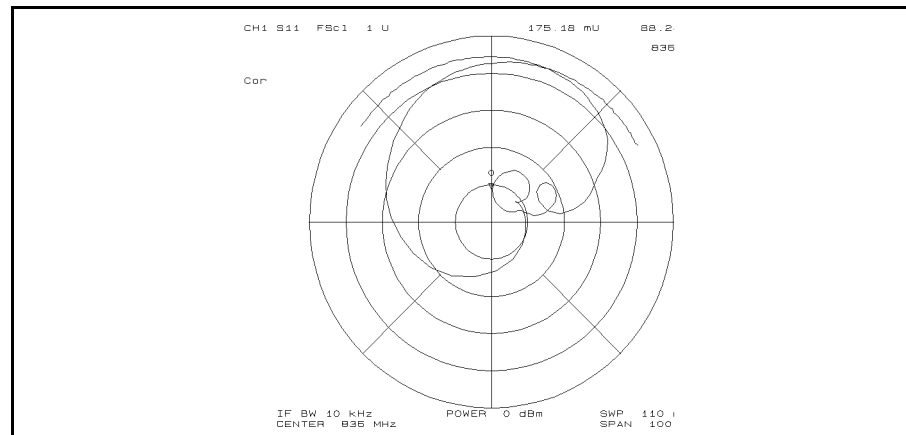

Figure 5-15. S_{11} on Polar Chart

Data Readout Using the Marker

Press **Marker** and use the knob to position the marker at any desired point on the trace. Then read the frequency, magnitude, and phase in the upper right hand corner of the display. Or, enter the frequency of interest from the data entry key pad to read the magnitude and phase at that point.

To read the marker data in logarithmic, linear, real/imaginary, impedance ($R+jX$), admittance ($G+jB$), or SWR/phase formats, press **Utility** **SMTH/POLAR MENU** and select the desired format.

Impedance Measurement

The amount of power reflection from a device is directly related to the impedance values of both the device and the measuring system. In fact, each value of the reflection coefficient (Γ) uniquely defines a device impedance. For example:

- $\Gamma=0$ occurs when the device and test set impedance are the same.
- A short circuit has a reflection coefficient of $\Gamma=1 \angle 180^\circ (= -1)$.
- An open circuit has a reflection coefficient of $\Gamma=1 \angle 0^\circ (= 1)$.

Every other value for Γ also corresponds uniquely to a complex device impedance, according to the equation

$$Z_n = \frac{1 + \Gamma}{1 - \Gamma}$$

Where Z_n is the DUT impedance normalized to (that is, divided by) the measuring system's characteristic impedance (usually 50 or 75 Ω). The network analyzer has a default impedance of 50 Ω . To set the impedance to 75 Ω , press **[Cal] MORE SET ZO**. The network analyzer uses the formula above to convert the reflection coefficient measurement data to impedance data.

1. Press **[Format] SMITH**. The display shows the complex impedance of the DUT over the frequency range selected.
2. Press **[Marker]** to turn on the marker. Then use the knob to read the resistive and reactive components of the complex impedance at any point along the trace. The marker displays a complex impedance readout.

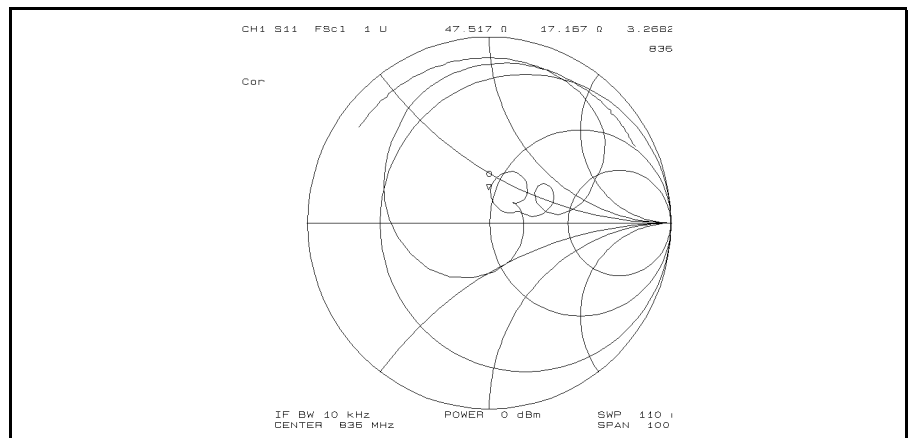

Figure 5-16. Impedance Measurement

Admittance Measurement

1. Press **Format** **MORE** **ADMITTANCE CHART**. The display shows the complex impedance of the DUT over the frequency range selected.
2. Use the knob to read the resistive and reactive components of the complex impedance at any point along the trace. The maker displays complex impedance readout.

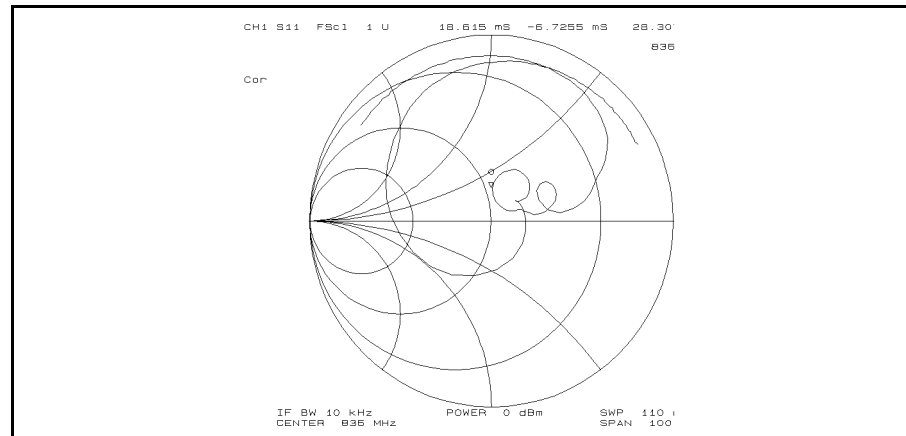

Figure 5-17. Admittance Measurement

List Sweep

The analyzer has a list sweep function that can sweep frequency according to a predefined sweep segment list. Each sweep segment is independent. For the network analyzer mode, each segment can have a different number of sweep points, power level, and IF bandwidth value. For the spectrum analyzer mode, each segment can have a different number of points and RBW.

A segment looks like a normal sweep setting. The list sweep function can combine up to 31 segments settings into 1 sweep. The analyzer can have two different sweep lists. One list for the network analyzer and the other list for the spectrum analyzer. When both channels are set to the same analyzer mode, both channels use the same list. This example describes the following two applications:

- Sweep time reduction for filter testing in the network analyzer mode (including the setup procedure).
- Dynamic range enhancement in the network analyzer mode.

Sweep Time Reduction

The following example creates a list sweep to measure a filter that has a 836 MHz center frequency and a 50 MHz bandwidth. This example uses the list sweep to reduce the sweep time by setting coarse sweep points for the rejection band and the fine sweep points for the passband.

Analyzer Settings

Press **[Preset]**. Then set the analyzer's controls as follows:

	Desired Setting	Key Strokes
Active Channel Block	Select channel 1	[Chan 1] (default)
Measurement Block	Select Network Analyzer	Press [Meas] ANALYZER TYPE NETWORK ANALYZER
	Select S ₂₁ (or B/R) measurement	Press [Meas] Trans:FWD S21 [B/R]
	Select LOG MAG format	[Format] FORMAT:LOG MAG (default)

Creating a Sweep List

Perform the following procedure to create a list (see the graph below):

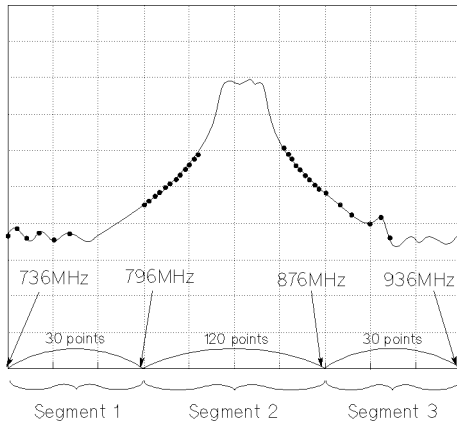

1. Press **[Sweep]** **SWEEP TYPE MENU** **EDIT LIST**.
2. To edit the list, press **EDIT**.
3. For segment 1:
 Press **[Start]** **736** **[M/μ]**.
 Press **[Stop]** **796** **[M/μ]**.
 Press **NUMBER of POINTS** **30** **[X1]** **SEGMENT DONE**.
4. For segment 2:
 Press **ADD**.
 Press **[Stop]** **876** **[M/μ]**.
 Press **NUMBER of POINTS** **120** **[X1]** **SEGMENT DONE**.
5. For segment 3:
 Press **ADD**.
 Press **[Stop]** **936** **[M/μ]**.
 Press **NUMBER of POINTS** **30** **[X1]** **SEGMENT DONE**.
6. Press **LIST DONE**.

The segments do not have to be entered in any particular order. The analyzer automatically sorts them in increasing order of sweep parameter value.

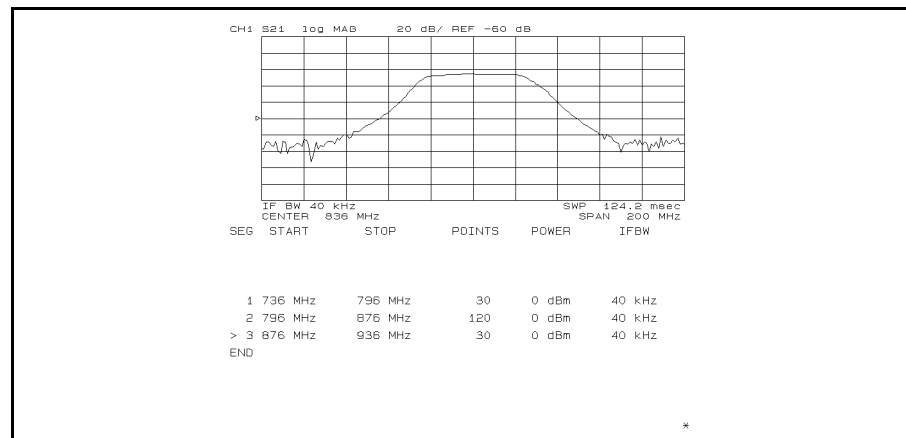

Figure 5-18. Sweep List Edit Display

Performing List Sweep

Press **[Sweep]** **SWEEP TYPE MENU** **LIST FREQ** to perform the list sweep measurement.

Dynamic Range Enhancement

Figure 5-19 shows the sweep list modified from the list of the previous example to improve dynamic range. Segments 1 and 2 have a narrow IF bandwidth and a higher power level for the stopband of the filter. Segment 3 has a wide IF bandwidth and lower power level for passband.

1. Press **(Sweep)** **SWEEP TYPE MENU** **EDIT LIST**.
2. To modify segment 1, press **SEGMENT 1** **(X1)** **EDIT**.
3. Press **POWER 15** **(X1)** **IFBW 10** **(X1)** **SEGMENT DONE**.
4. To modify segments 2 and 3, see Figure 5-19 for the values and modify them in a manner similar to steps 2 and 3.
5. Press **LIST DONE**.

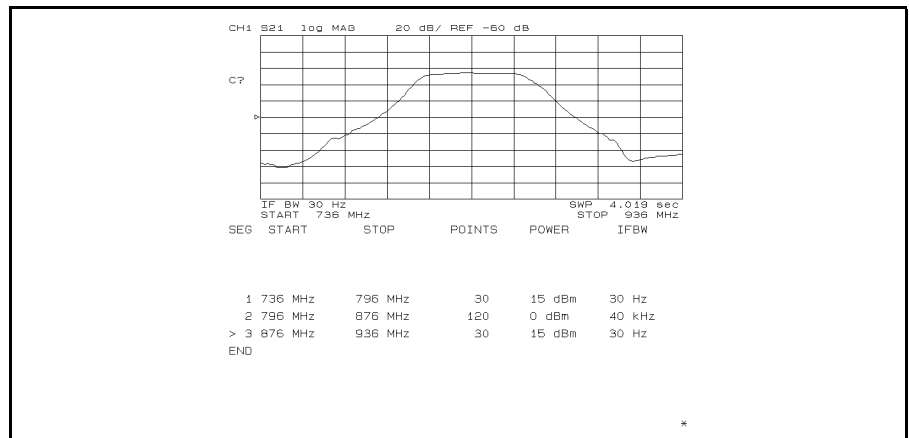

Figure 5-19. Dynamic Range Enhancement

The **(Save)** key can save sweep lists along with all other current instrument settings (see the *Task Reference*).

Filter Testing Using Limit Lines

The analyzer has limit line/testing functions for go/no-go testing. The limit lines define upper and lower limits. The limit testing functions compare the measured data to the limit lines and indicate the result. The following example is a practical method for setting up limit lines to test a bandpass filter.

Example of Limit Lines For Filter Testing

This example creates limit lines to test a 70 MHz crystal bandpass filter.

Analyzer Settings

Press **[Preset]**. Then set the analyzer's controls as follows:

	Desired Setting	Key Strokes
Active Channel Block	Select channel 1	[Chan 1] (default)
Measurement Block	Select S ₂₁ (or B/R) measurement Select LOG MAG format	Press [Meas] Trans:FWD S21 [B/R] [Format] LOG MAG (default)
Sweep Block	Center frequency 836 MHz Span frequency 100 MHz Number of points 401	Press [Center] 836 [M/μ] Press [Span] 100 [M/μ] Press [MENU] NUMBER of POINTS 401 [x1]

Creating Limit Lines

Perform the following procedure (see Figure 5-20):

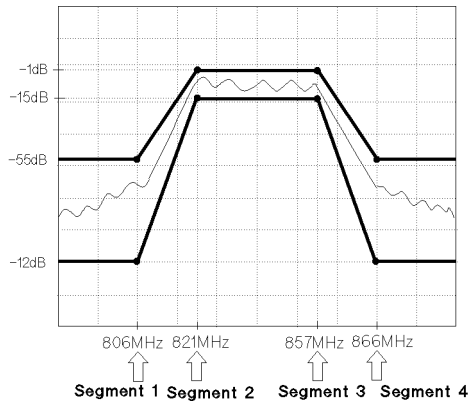

1. Press **(System) LIMIT MENU LIMIT LINE** on **OFF** to **ON** off.
2. Press **EDIT LIMIT LINE EDIT**.
3. For segment 1:
 Press **SWP PARAM VALUE 806 (M/μ)**.
 Press **UPPER LIMIT -55 (x1)**.
 Press **LOWER LIMIT -120 (x1) DONE**.
4. For segment 2:
 Press **ADD SWP PARAM 821 (M/μ)**.
 Press **UPPER LIMIT -1 (x1)**.
 Press **LOWER LIMIT -15 (x1) DONE**.
5. For segment 3:
 Press **ADD SWP PARAM 851 (M/μ) DONE**.
6. For segment 4:
 Press **ADD SWP PARAM 866 (M/μ)**.
 Press **UPPER LIMIT -55 (x1)**.
 Press **LOWER LIMIT -120 (x1) DONE**.
7. Press **DONE**.

The limit line segments do not have to be entered in any particular order. The analyzer automatically sorts them and lists them on the display in the increasing order of sweep parameter value.

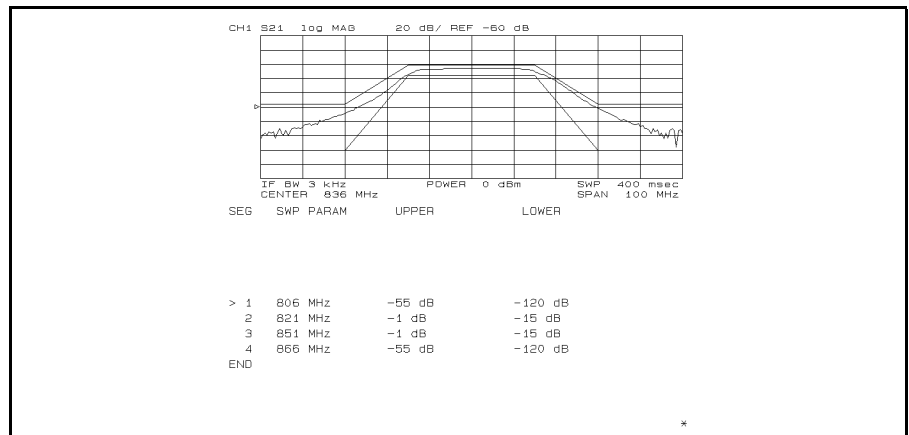

Figure 5-20. Editing the Limit Lines

Performing Limit Test

Press **LIMIT TEST** on **OFF** to **ON** off to perform limit testing using the limit lines you just edited. When the limit lines and testing are turned on, an out-of-limit test result is normally indicated in six ways:

- With a FAIL message on the screen.
- With a beep (on/off selectable).
- With an asterisk in tabular listings of data (under **(Copy)**).
- With a bit in GPIB event status register B.

- With a bit in the I/O port on the rear panel.
- With the GPIB commands OUTPLIMF?, OUTPLIMIL?, and OUTPLIMM?.

Separated Limit Lines

Figure 5-21 shows separated limit lines and an editing table example. This example can be used for filter testing that only requires insertion loss limits. Dummy limit values (+5000 for upper and -5000 for lower, for example) should be entered for the no limit areas.

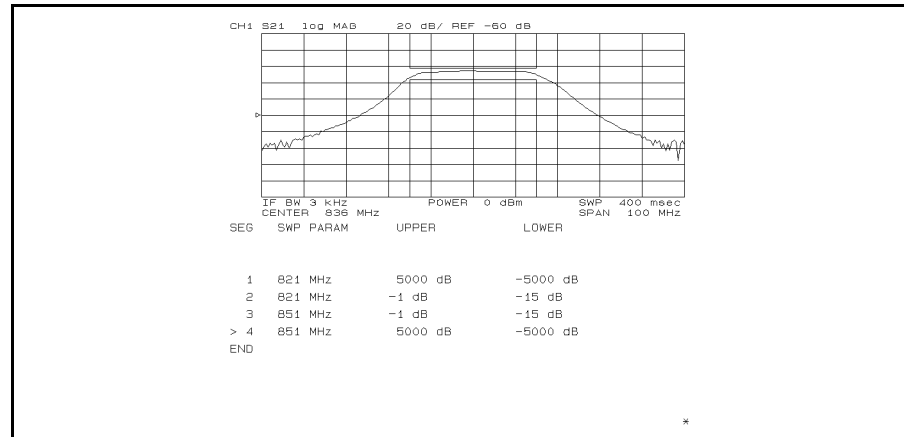

Figure 5-21. Separated Limit Lines

- Limits are only checked at each of the actual measured data points. It is possible for a device to be out of specification without a limit test failure indication if you do not select sufficient sweep parameter points within a segment.
- By combining the limit test and the list sweep function, high throughput limit line/testing can be performed for go/no-go testing. For detailed information on the list sweep, see “List Sweep” in this chapter.
- Limit line information is lost if you press **(Preset)** or turn off the power. However, the **(Save)** keys can save the limit line information along with all other current instrument settings when the limit lines are on. See the *Task Reference* manual for details.

Gain Compression Measurement

An important measure of active circuits is how well they handle a signal frequency with a varying input amplitude. By using the power sweep function in the network analyzer mode, measurements such as gain compression or automatic gain control slope can be made.

Measurement Setup

Connection

Set up the analyzer as shown in Figure 5-22.

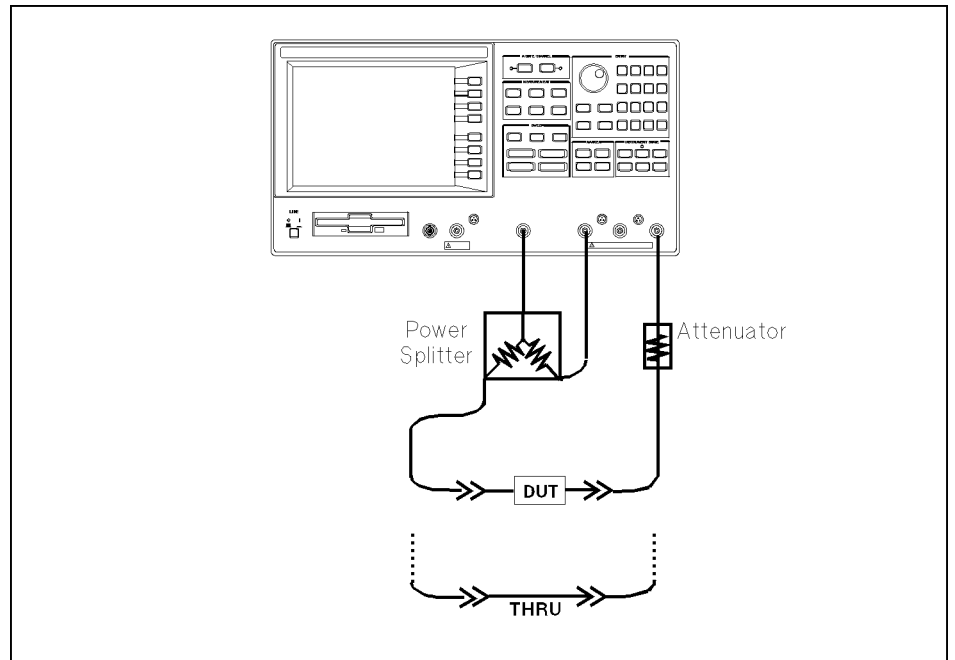

Figure 5-22. Gain Compression Measurement Setup

Analyzer Settings

Press **[Preset]**. Then set the analyzer's controls as follows:

	Desired Settings	Key Strokes
Active Channel Block	Select channel 1	[Chan 1] (default)
Measurement block	Select Network Analyzer	Press [Meas] ANALYZER TYPE NETWORK ANALYZER
	Select S_{21} (or B/R) measurement	Press [Meas] Trans:FWD S21 [B/R]
	Select LOG MAG format	[Format] LOG MAG (default)
	IF BW 10 kHz	[Bw/Avg] 10 [k/m]
Sweep block	Select power sweep	Press [Sweep] SWEEP TYPE POWER
	Start power -20 dBm	Press [Start] -20 [x1]
	Stop power 0 dBm	Press [Stop] 0 [x1]

Performance Calibration

Perform a power response calibration for this measurement as follows:

1. Press **Cal** **CALIBRATION MENU** **RESPONSE**.
2. Connect a THRU calibration standard between the measurement cables in place of the DUT (see Figure 5-22).
3. Press **THRU** to perform a power response calibration data measurement.
4. Press **DONE:RESPONSE**. (**CORRECTION on OFF** is automatically set to **CORRECTION ON off**.)

Measurement

5. Replace the THRU standard with the DUT.
6. Press **Scale Ref** **AUTO SCALE** if the trace needs to be rescaled.
7. Press **Search** **MAX** to move the marker to the maximum point on the trace.
8. Press **Marker** **ΔMODE MENU** **ΔMkr** to set the Δmarker to the maximum point.
9. Press **Search** **TARGET** **-1** **(X1)** to search for the point of the gain compression. (See Figure 5-23.)

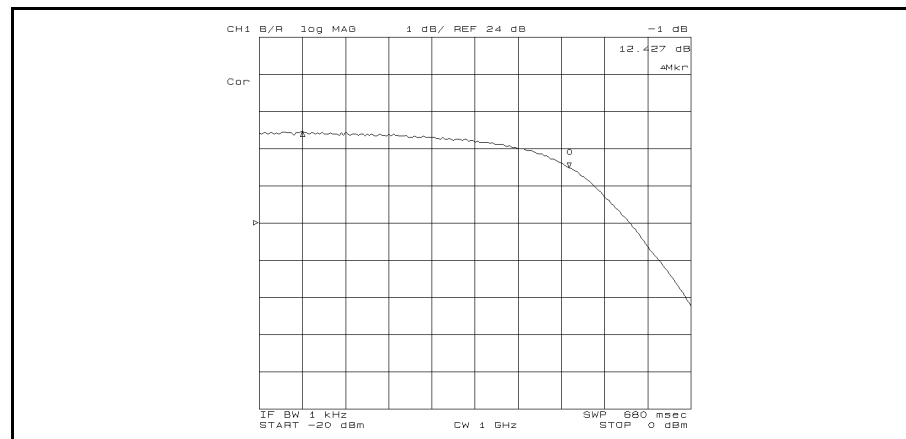

Figure 5-23. Gain Compression

Absolute Output Level Measurement

The analyzer can show the characteristics input level versus output level by using the absolute measurement capability in the network analyzer mode.

1. Press **(Sweep)** CHAN COUP on OFF to CHAN COUP ON off to couple the sweep parameters of both channels.
2. Press **(Marker)** MKR COUP on OFF to MKR COUP ON off to couple the marker between both channels.
3. Press **(Chan 2)** **(Meas)** B to select the absolute measurement at the B input.
4. Press **(Display)** DATA MATH [DATA] OFFSET. Then input the value of the attenuator that is connected between the DUT and the B input. In this example measurement, a 30 dB attenuator is used. Therefore, enter 30 **(X1)**.
5. Press **(Scale Ref)** AUTO SCALE if the trace needs to be rescaled.
6. The analyzer displays the input versus output power levels. The marker shows the input and output power levels at the -1 dB gain compression point.
7. Press **(Display)** DUAL CHAN on OFF to ON off to display both channel (see Figure 5-24). Note that you must subtract 3 dB from the input value readout. This is necessary because the input signal is attenuated by the power splitter that is between the RF OUT and the DUT.

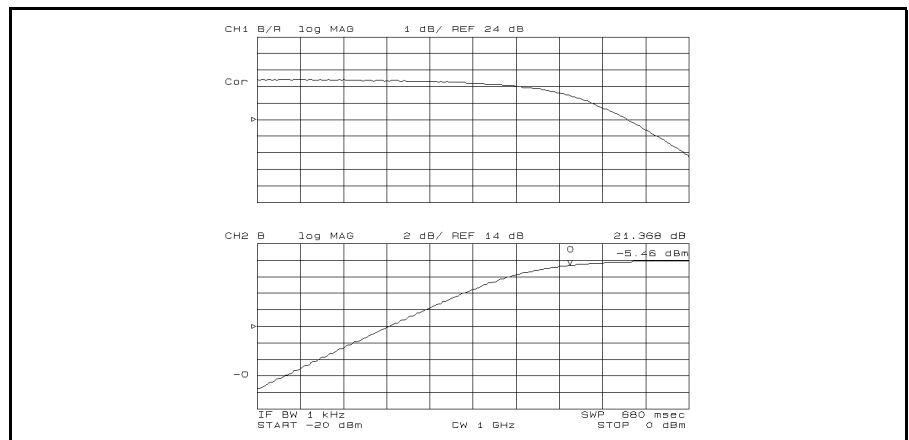

Figure 5-24.
Input vs. Output Power Level at the -1 dB Gain Compression Point

For More Information

The User's Guide provides an overview of the analyzer and typical applications using the analyzer. You may need or want more information on the analyzer's features. The following table shows you where to find that information:

Calibration	
How to perform calibration for the network analyzer mode	Chapter 4 in the <i>Task Reference</i> .
How to perform level calibration for the spectrum analyzer mode	Chapter 2 in the <i>Task Reference</i>
Softkey reference	Chapter 5 in the <i>Function Reference</i> .
Principles of calibration	Chapter 12 in the <i>Function Reference</i> .
Disk and Memory	
How to use disk and memory storage	Chapter 6 in the <i>Task Reference</i> .
Softkey reference	Chapter 8 in the <i>Function Reference</i> .
File system information	Appendix C in the <i>Function Reference</i> .
Print	
How to print	Chapter 6 in the <i>Task Reference</i> .
Softkey descriptions	Chapter 8 in the <i>Function Reference</i> .
Printer available	Chapter 9 in the <i>Function Reference</i> .
Controlling by GPIB	
How to control the analyzer by GPIB	See <i>GPIB Programming Guide</i>
GPIB command reference	See <i>GPIB Command Reference</i> .
SCPI command reference	See <i>GPIB Command Reference</i> .
Instrument BASIC	
How to use HP Instrument BASIC	See <i>Using HP Instrument BASIC</i> .
HP Instrument BASIC command	See <i>HP Instrument BASIC Users Handbook</i> .
Specifications	Chapter 10 in the <i>Function Reference</i> .
Accessories	
How to connect	Appendix A in this guide.
Optional accessories available	Chapter 9 in the <i>Function Reference</i> .
Furnished accessories	Chapter 10 in the <i>Function Reference</i> .
Default Setting	Appendix D in the <i>Function Reference</i> .
Measurement Basic	Chapter 12 in the <i>Function Reference</i> .
Error Messages	See Messages in the <i>Function Reference</i> .
I/O port	
How to use	Chapter 10 in the <i>Programming Guide</i> .
Descriptions	Chapter 12 in the <i>Function Reference</i> .
Manual Set	
Organization of manual set	See the "Documentation Map" in the front matter of each manual.

You can also use the Table of Contents and the Index of each manual to find the specific information you need.

Index

8 85046A/B S-parameter Test Set , 5-1

- A**
 - accessory, A-1
 - active channel
 - setting , 2-4, 3-5
 - ADMITTANCE CHART , 5-18
 - admittance measurement , 5-18
 - AM signal measurement , 4-10
 - analyzer settings
 - recalling , 2-15
 - saving , 2-13
 - analyzer type
 - setting to network , 3-6
 - setting to spectrum , 2-5
 - ANALYZER TYPE , 4-3, 5-2
 - aperture , 5-11
 - automatic scaling
 - performing , 3-9
 - AUTO SCALE , 5-3, 5-6

- B**
 - bandwidth , 5-4
 - beep , 5-23
 - burst signal measurement , 4-16

- C**
 - Cal , 5-2
 - CALIBRATE MENU , 5-2
 - calibration, A-1
 - frequency response, A-1
 - frequency response , 5-2
 - full two port, A-1
 - one path two port, A-1
 - one port reflection, A-1
 - procedure , 5-2
 - standards, A-1
 - thru, A-1
 - thru , 5-2
 - transmission measurement , 5-2
 - CAL OUT signal , 2-3
 - CHAN COUP on OFF , 5-27
 - cleaning , 1-6
 - C/N Measurement , 4-4
 - command
 - GPIB, A-1

Instrument BASIC, A-1
Contents, 1-1
CORRECTION ON off , 5-2
COUPLED CH on OFF , 5-6
COUPLED CH ON off , 5-5
CROSS CHAN on OFF , 4-13, 5-5

D DATA and MEMORY , 4-14
DATA HOLD [OFF] , 4-14
DATA MATH [DATA] , 5-27
DATA→MEMORY, 4-14
DELAY , 5-11
Δmarker, 4-4
ΔMODE MENU , 4-3
deviation from linear phase , 5-10
directivity, A-1
disk, A-1
 preparing , 2-12
distortion measurement , 4-3
DOS , 2-13
DUAL CHAN on OFF , 4-6
DUT
 connecting , 3-3
dynamic range , 5-21

E edge mode , 4-17
EDIT LIMIT LINE , 5-22
EDIT LIST , 5-20
ELEC DELAY MENU , 5-8
electrical length , 5-8
envelope , 4-14
EXPANDED PHASE , 5-7
EXTERNAL , 4-18

F fail message , 5-23
file name
 entering , 2-13
filename , 2-14
filter measurement , 5-2, 5-19, 5-22
FIXED ΔMKR , 4-15
flatness , 5-5
FM signal measurement , 4-12
frequency deviation , 4-12
frequency range
 setting , 2-6, 3-8
frequency response, A-1
Fuse Selection, 1-3

- G**
 - gain compression measurement , 5-25
 - gate delay , 4-18
 - GATE DELAY , 4-17
 - gated sweep , 4-17
 - gate length , 4-18
 - GATE LENGTH , 4-17
 - GATE [LEVEL] , 4-17
 - go/no-go testing , 5-22
 - GPIB, A-1
 - group delay , 5-10
 - GROUP DELAY APERTURE , 5-11

- H**
 - hardcopy of LCD
 - making , 3-14
 - harmonic distortion measurement , 4-2
 - harmonics
 - searching , 2-11

- I**
 - impedance measurement , 5-17
 - incoming inspection , 1-1
 - input
 - selecting for network mode , 3-7
 - selecting for spectrum mode , 2-6
 - insertion loss , 5-2
 - Instrument BASIC, A-1

- K**
 - keyboard , 2-13

- L**
 - LEFT PEAK , 4-13
 - LIF , 2-13
 - limit line function
 - check points , 5-24
 - insertion loss testing , 5-24
 - lower limit , 5-22
 - segment , 5-22
 - upper limit , 5-22
 - limit line function , 5-22
 - LIMIT LINE ON off , 5-22
 - LIMIT MENU , 5-22
 - limit test function , 5-22
 - LIMIT TEST ON off , 5-23
 - LINE , 2-3
 - line stretchers , 5-8
 - LIST FREQ , 5-20
 - list sweep function
 - segment , 5-19
 - sweep list , 5-19
 - list sweep function , 5-19
 - low level signal , 2-9

- M** marker
 reading value , 3-12
 marker , 2-8, 4-3
 marker list , 4-3
 marker noise form , 4-4
 MARKER→DELAY , 5-8
 memory, A-1
 MKR COUP on OFF , 5-27
 MKR LIST on OFF , 4-3
 MKR NOISE FORM on OFF , 4-4
 MKR ON [DATA] , 4-15
 MKR ON [MEMORY] , 4-15
 MKR→REFERENCE , 4-4, 5-5
 MKR ZOOM , 4-13
 modulating frequency , 4-10, 4-13
 modulation index , 4-10
 MULTIPLE PEAKS , 4-3
 multiple peak search , 4-3
- N** NETWORK ANALYZER , 5-2
 network measurement, 5-1
 NEXT PEAK , 4-12
 number of points , 5-20
 NUMBER of POINTS , 4-18
- O** OFFSET , 5-27
- P** Part Number, 1-1
 pass message , 5-23
 PEAK DEF MENU , 5-5
 peak level
 read by marker , 2-8
 PEAK PLRTY POS neg , 5-5
 peak search , 5-5
 phase distortion , 5-10
 phase measurements , 5-6
 POLAR , 5-16
 polar chart , 5-16
 Power Cable, 1-4
 preset marker , 4-3
 PRESET MKRS , 4-3
 Presetting , 2-15
 printer
 configuring and connecting , 3-14
 programming, A-1

R RBW
 setting , 2-9
 rbw setup time , 4-17
 reflection coefficient , 5-12
 reflection measurement , 5-12
 repetitive sampling mode , 4-17
 RESPONSE , 5-2
 response calibration
 performing , 3-10
 response calibration , 4-8
 return loss , 5-12
 RIGTH PEAK , 4-13
 ripple , 5-5

S sampling mode , 4-17
 SAMPLING NORM rept , 4-18
 (Save) , 5-21, 5-24
 SCALE/DEV , 5-5
 search function
 using , 2-11
 SEARCH:PEAK , 4-12
 SEARCH:PEAKS ALL , 4-3
 SEARCH TRK on OFF , 4-3
 setup time , 4-17
 SET Z0 , 5-17
 SIGNAL TRK on OFF , 4-6
 SMITH , 5-17
 source match, A-1
 S-parameter test set , 3-3
 specifications, A-1
 SPECTRUM ANALYZER , 4-3
 spectrum measurement , 4-1
 spectrum monitor , 4-7
 storage, A-1
 sub-marker , 4-3
 suffix , 2-16
 SWEEP:HOLD , 4-17
 sweep time , 5-19
 SWEEP TIME , 4-18
 SWEEP TYPE MENU , 5-20
 swr , 5-12

- T** TARGET , 5-26
test signal source
 connecting , 2-3
THRU , 5-2
time domain measurement , 4-17
tracking Δ marker, 4-3
TRACKING Δ MKR , 4-3
tracking drifting signal , 4-5
transmission/reflection test set , 3-3
TRIGGER: [FREE RUN] , 4-17
trigger mode , 4-17
turning ON , 2-3, 3-3
- V** ventilation requirement, 1-6
video bandwidth , 4-4
VIDEO BW , 4-4
- W** wide band fm signal , 4-12
WIDTH on OFF , 5-4
WIDTH VALUE , 5-4
- Z** zero span , 4-17
ZOOMING APERTURE , 4-13
zooming function , 4-13