

# MICROPROCESSOR PROGRAMMER -CONTROLLER RE15



USER'S MANUAL





## CONTENTS

<b>1. APPLICATION</b>	4
<b>2. CONTROLLER SET</b>	6
<b>3. INSTALLATION AND BASIC SAFETY REQUIREMENTS</b>	7
<b>4. SERVICING</b>	14
<b>5. CONTROLLER PARAMETERS</b>	19
5.1. List of parameters	19
5.2. Kinds of alarms	27
5.3. Pulse repetition period	28
5.4. Linear additional input	28
5.5. Binary input	29
5.6. Three-state control	30
5.7. Three-state step by step control	30
5.8. Security code	31
<b>6. SPECIAL FUNCTIONS</b>	32
6.1. Calling of special functions	32
6.2. Manual control	32
6.3. Selection of PID controller settings	33
6.4. Measurement of the two-wire line resistance	33
6.5. Retreat to the producer settings	33
<b>7. PROGRAMMED CONTROL</b>	34
7.1. Defining set point programs	34
7.2. Control by set point program	36
<b>8. SELECTION OF PID SETTINGS</b>	37
8.1. Self-adapting control system	37
8.2. Manual selection of PID settings	39
<b>9. TECHNICAL DATA</b>	41
<b>10. EXECUTION CODES AND ORDERING</b>	45
<b>11. MAINTENANCE AND GUARANTEE</b>	46

# 1. APPLICATION

The RE15 microprocessor controller is destined to control the temperature or other physical quantities, e.g. pressure, humidity, level, converted into an electric signal.

The set point can be constant, changed during the process operation or read out from the additional input. 15 programs of the setpoint are available.

Measured values, set point, output signal and program parameters are displayed on two displays and two bargraphs.

The controller has four outputs enabling the continuous control, two-state control, three-state of heating-cooling type control, three-state step-by-step control, alarm signalling and retransmission.

The binary input serves to control the set point or to switch over on the manual operation.

The function of the automatic selection of PID controller settings ensures a satisfactory control quality.

The RS-485 interface with MODBUS protocol gives the possibility to apply the controller in control systems.

## FEATURES

### ● General:

- dual displays (4 digits with 7-segments each),
  - the upper red, to display the process value ,
  - the lower green, configurable for display the setpoint, control power, measured value at auxiliary input, state of digital input or program parameters,
- two bargraphs (red and green) 21 points each, configurable to display control power, setpoint or process value,
- four indicators for outputs state,
- four buttons to configure the controller,

### ● Inputs:

- up to 2 analogue inputs, each sampled twice a second,
- universal configurable main input: The input will accept all standard thermocouples, the Pt100 resistance thermometers, milliamps or volts,

- auxiliary linear input configurable for remote setpoint or for an additional process value for control (sum or difference or average to main input) or for extra measurement (for example a position feedback potentiometer at motorized valve control),
- digital input (non-voltage contact) for remote program control - stop/run, hold, reset input is active when closed.

● **Outputs:**

- four outputs (see ordering code),
- up to 2 analogue outputs - configurable 0-10 V, 0-5 V, 0-20 mA, 4-20 mA,
- each output can be configured as control output or alarm or retransmission (analogue only), or event output,

● **Digital communications: RS485; MODBUS ASCII and RTU protocol**

● **Setpoint:**

- local with soft start
- remote from auxiliary input
- ramp/soak: 15 programs

● **Control:**

- The RE15 can be configured for heating, cooling, heating/cooling, cooling/cooling or for motorised valve control.  
The valve control algorithm does not require a position feedback potentiometer.

● **Programmer parameters:**

- 15 programs,
- 15 segments per program,
- ramp segments 0.1...999.9 units/min.,
- soak segments 00:01...99:59 minutes,
- event outputs at segments,
- start at process value,
- holdback function,
- number of cycles 1...99,

● **Alarms:**

- number : 0...4,
- deviation : high, low or band,
- full scale : high or low,
- full scale: main or auxiliary input,
- sensor break alarm,
- latched : on or off
- hysteresis: 0...99.9 units

● **Extra functions:**

- two selectable autotuning algorithms are available: with the load cool and at the setpoint. They calculate PID settings for accuracy control,
- retransmission of the setpoint or PV; configurable span,
- two security codes protect all (except setpoint) parameters,
- hand or automatic mode with bumpless switching,
- reset to factory settings,

● **A setup program CONTROL is available for easy configuration from a PC.**

## 2. CONTROLLER SET

The controller set includes:

- |                            |       |
|----------------------------|-------|
| - RE15 controller          | 1 pc  |
| - service manual           | 1 pc  |
| - guarantee certificate    | 1 pc  |
| - holders                  | 4 pcs |
| - seals                    | 1 pc  |
| - interface service manual | 1 pc  |

### 3. INSTALLATION AND BASIC SAFETY REQUIREMENTS

One should insert the controller in the prepared hole ( $92^{+0.6} \times 45^{+0.6}$ ) mm in the panel which dimensions are given on the Fig. 1 and fix it by means of four holders (delivered with the controller). The panel thickness cannot exceed 15 mm.

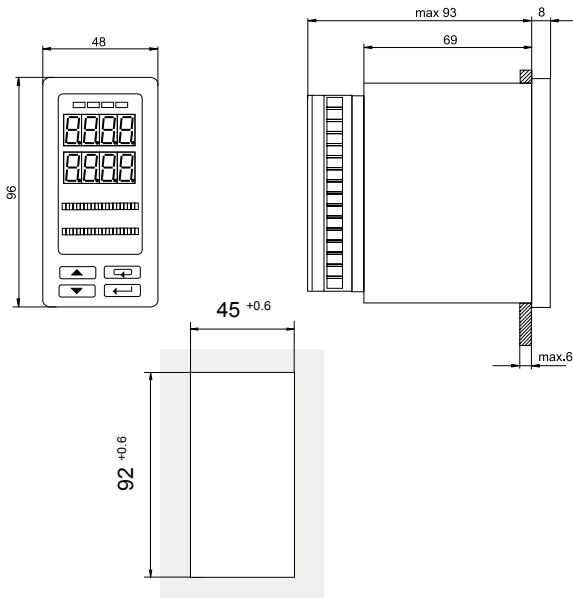

**Fig. 1 Overall and panel cut-out dimensions**

The RE15 controller fulfils requirements concerning the service safety in accordance with EN 61010 standard and EMC immunity against interference occurring in the industrial environment containing a certain amount of noise in the form of transient voltages and spikes, according to EN 61000-6-2 standard.

Different interference sources practically occurring influence the controller indications in a continuous or pulse way from the side

of the main supply (as the result of other device action) and also overlaps the measured signal or controller auxiliary circuits.

Interference also arises as the result of switching capacitance-inductive loads by own controller relays.

In particular, important impulse interference are dangerous for the device operation because they can cause sporadic wrong measurement results or accidental alarm operations, despite the application of appropriate filters in the controller.

The noise level should be reduced to a value lower than the controller immunity threshold, first of all through an appropriate controller installation in the object.

**In order to obtain a full controller immunity against electromagnetic interference in the environment with an unknown noise level it is recommended to observe following principles:**

- do not supply controllers from the mains in the proximity of devices generating important impulse interference,
- use network filters for the group of controllers servicing the same object,
- to lead supply conductors, use metallic screens in the shape of conduits or braids, in which one can also lead the ground conductor and the mains conductors of the given controller alarm relays.
- lead individually the connections of the communication interface circuits in a screen as above, with twisted conductors,
- conductors leading measuring signals to the controller should be of twisted-pair construction, and for resistance thermometers in three-wire connection, twisted with conductors of the same length, cross-section and resistance, and led in a screen as above.
- apply the general principle that conductors (group of conductors) leading different signals should be led in the greatest distance from each other ( not less than 30 cm) and crossings of such conductors must be executed at right angle.

In the controller rear part there are two sockets of terminal strips, to which the mains and external circuits are connected.



Electrical connections must be carried out acc. the Fig.2.

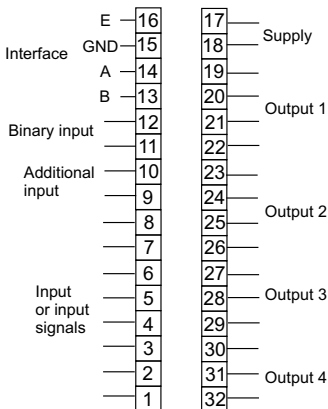

a) Description of the terminal strips

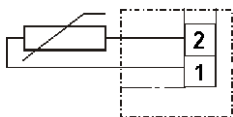

Resistance thermometer in a two-wire connection or resistance measurement

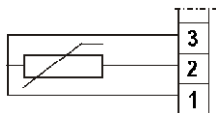

Resistance thermometer in a three-wire connection

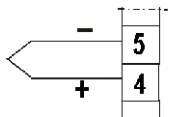

Thermocouple

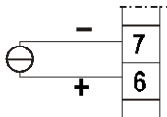

Current input  
0/4...20 mA

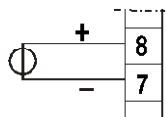

Voltage input  
0/5...10 V

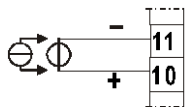

Additional current  
or voltage input

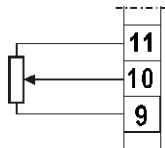

Additional potentiometric  
input

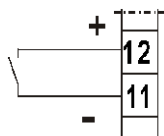

Binary input

*b) Input signals*

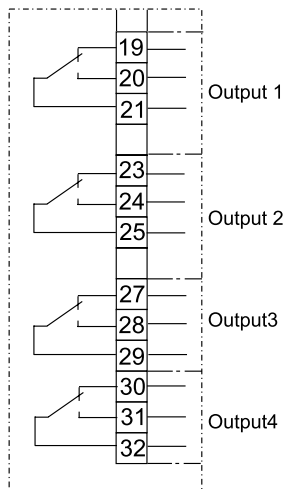

Relay outputs

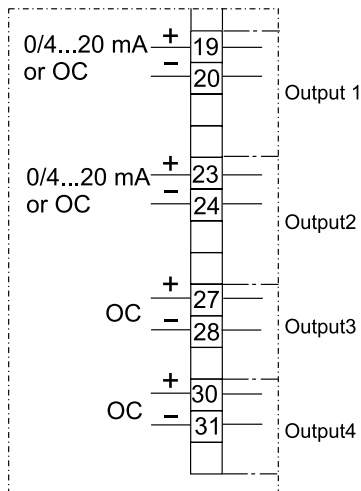

Current outputs or OC

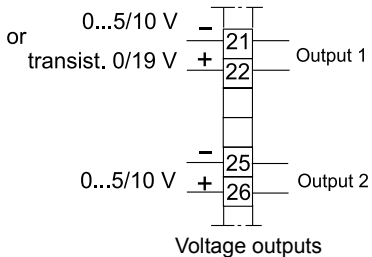

c) Output signals

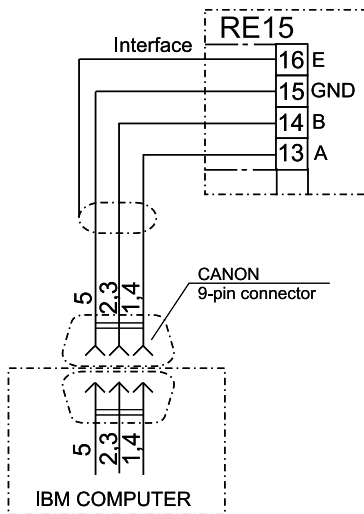

d) RS-485 interface

**Fig.2 Electric diagrams of the controller**

## **Basic requirements and user's safety**

RE15 controllers are intended to be installed into panels, switchboards and cubicles.

They are in conformity with IEN 61010-1 standard for safety requirements.

### **Remarks concerning safety:**

The installation should be carried out by a qualified staff.

One must consider all accessible aspects of the protection.

The controller leaves the factory in perfect condition regarding technical safety. In order to maintain this condition and to ensure a safe operation, the user must comply with indications and markings contained in the service manual and following instructions:

- Before installation or beginning any trouble shooting procedures the power to all equipment must be turned off and isolate. Units suspected of being faulty must be disconnect and removed to a properly equipped workshop for testing and repair.
- Component replacement and internal adjustments must be made by qualified maintenance personnel only.
- Before mounting, ensure that the operating voltage and mains voltage are the same, and then proceed with installation.
- The power supply must be connected as shown in the relevant diagram.
- Before the turning-on, check the correctness of all connections.
- Before any maintenance and/or repairs, whenever the instrument must be opened, it must be disconnected from all power sources.

- Do not use this controller in areas subject to hazardous conditions such as excessive shock, vibration, dirt, moisture, corrosive gases or oil. The ambient temperature of the areas should not exceed the maximum rating in the Technical Data chapter.
- If there is ever the suspicion that safe use is no longer possible, the instrument must be taken out of service and precautions taken against any accidental use.
- Operation is no longer safe when:
  - there is clearly visible damage,
  - the instrument no longer functions,
  - after lengthy storage in unfavourable conditions,
  - after any serious damage incurred during the transport.

### **Operator safety**

The controller described in this service manual is intended for use by properly trained staff only.

All wiring must be conform to appropriate standards of good practice and local codes and regulations. Wiring must be carried out only by authorised personnel.

For proper, safe use of the instrument and for maintenance and/or repairs, it is essential that the persons instructed to carry out these procedures follow normal safety precautions

## 4. SERVICING

The frontal plate of the controller is shown on the Fig. 4

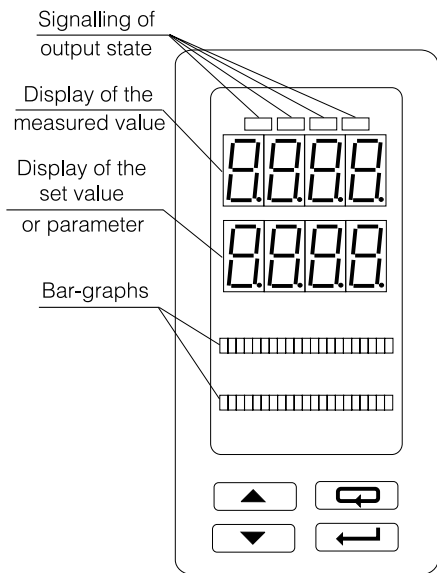

**Fig.4. View of the controller frontal plate**

## Push-button functions:



- change of set point or the program number
- calling the menu of working parameters (3 sec),
- entry into the parameter change mode,
- acceptance of the introduced data.



- display of the next parameter,
- increase of the parameter value.



- display of the previous parameter
- decrease of the parameter value,
- calling of special functions (3 sec.).



- return to the previous level,
- resignation of introduced changes,
- calling of the menu of controller configuration.

The controlled value is displayed on the upper display. The controlled value is the value measured on the main input or the sum, difference or arithmetic mean of measured values on both inputs (parameter  $F$ ,  $n2$  set on the value  $Rnd$ ,  $d$ ,  $FF$ , or  $SEd$ ) is displayed on the upper display.

The set value or process parameters marked by an appropriate symbol are displayed on the lower display:

- $h$  driving signal of the channel I,
- $c$  driving signal of the channel II (cooling),
- $R$  measured value on the main input (when the controlled value is the function of two inputs),
- $u$  measured value on the additional input,
- $b$  state of the binary input (when  $F$ ,  $nb \neq 0FF$ ),
- $P$  number of the performed program
- $n$  number of the realised section during the programmed control,
- $t$  time which remains till the end of the section in the programmed control,
- $l$  quantity of cycles which remains to end the operation.

On fig. 5 and 6, the diagram of controller servicing is presented suitably for constant-value and programmed control.

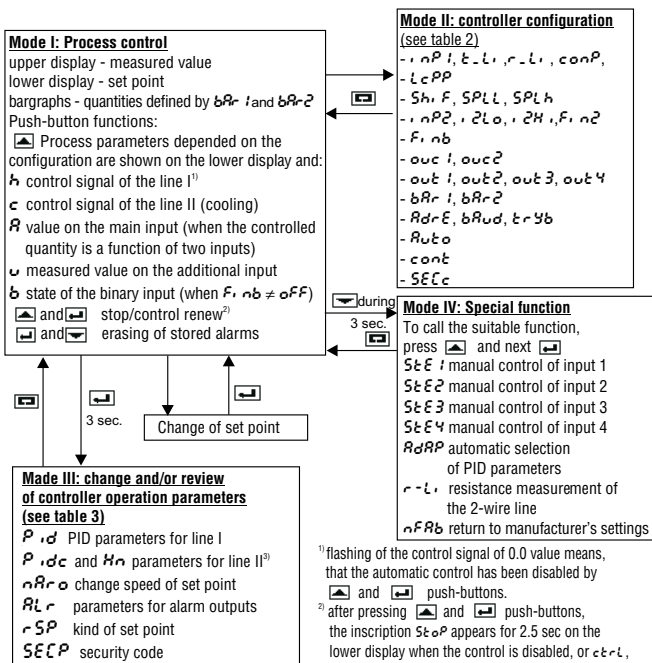

<sup>1)</sup> flashing of the control signal of 0.0 value means, that the automatic control has been disabled by  and  push-buttons.

<sup>2)</sup> after pressing  and  push-buttons, the inscription  $SEoP$  appears for 2.5 sec on the lower display when the control is disabled, or  $ctrt$ , when the control was renewed.

<sup>3)</sup> parameters appears only for the control with two lines.

**Fig.5. Service diagram for the constant valued control ( $rSP = con$ )**



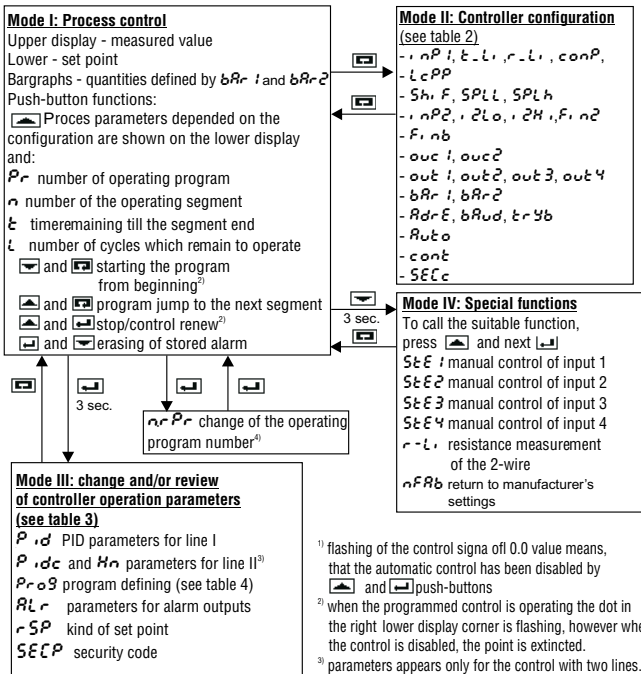







- <sup>1)</sup> flashing of the control signal of 0.0 value means, that the automatic control has been disabled by [▲] and [▼] push-buttons
- <sup>2)</sup> when the programmed control is operating the dot in the right lower display corner is flashing, however when the control is disabled, the point is extinguished.
- <sup>3)</sup> parameters appears only for the control with two lines.
- <sup>4)</sup> the number of the operating program can be changed only when the program is stopped or finished. The acceptance of a new number causes the start of the selected program from the beginning.

**Fig.6 Service diagram for the programmed control ( $rSP=P_r o 9$ )**

After the mains turn-on the program version is displayed. After the first turn-on, the Pt100 sensor is set. If another sensor is connected to the controller, one must change the  $SP1$  parameter. The set point is adjusted on the beginning of the measuring range

The parameter change follows after pressing the  key:

- for numerical parameters; the less significant digit is flashing, change the value by means of  and  keys. The acceptance of the introduced value follows after pressing the  key. The change of the number value is carried out in the range defined for the changing parameter.
- for non-numerical parameters the whole lower display is flashing. After pressing  and  keys, successive inscriptions defined for the changing parameter appear on the display.

The acceptance of the introduced value follows after pressing the  key, the resignation of introduced changes after pressing the  key.

In case of any abnormality appearance in the controller operation or error in electrical connections an appropriate error code appears in the upper display.

## Error codes

Table 1

Error code	Reason	Solution
$LEr1$	Shorting in the sensor circuit or exceeding of the lower measuring range on the main input	Change or correctly connect the sensor, check if the type of the selected sensor is in conformity with the connected one, replace the sensor
$HEr1$	Break in the circuit, lack of sensor or exceeding of the upper measuring range on the main input.	Change or correctly connect the sensor, check if the type of the selected sensor is in conformity with the connected one, replace the sensor
$LEr2$	Shorting in the sensor circuit or exceeding of the lower measuring range on the main input	Change or correctly connect the sensor, check if the type of the selected sensor is in conformity with the connected one, replace the sensor
$HEr2$	Break in the circuit, lack of sensor or exceeding of the upper measuring range on the main input.	Change or correctly connect the sensor, check if the type of the selected sensor is in conformity with the connected one, replace the sensor

## 5. RE15 CONTROLLER PARAMETERS

### 5.1. List of parameters

Parameters are set together in tables 2 and 3. Parameters concerning programs of the set points are presented in the table 4.

List of configuration parameters - Mode II

Table 2

It.	Parameter name	Symbol on the display	Manufacturer setting	Range of changes	Explanations
1.	Kind of input	$\rho P I$	$Pt I$ <sup>5)</sup>	$Pt I$ $Pt 100$ $Ni I$ $Cu I$ $t . J$ $t . T$ $t . K$ $t . S$ $t . R$ $t . B$ $t . E$ $t . N$ $t . ch$ $r r - r$ $0 - 20$ $4 - 20$ $0 - 10$ $0 - 05$	Pt100 Pt1000 Ni100 Cu100 Thermocouplet J Thermocouplet T Thermocouplet K Thermocouplet S Thermocouplet R Thermocouplet B Thermocouplet E Thermocouplet N Thermocouple chromel-kopel 0...400 $\Omega$ 0...20 mA 4...20 mA 0...10 V 0...05 V
2.	Type of line	$t - L$	$2 - P$	$2 - P$ $3 - P$	2-wire line 3-wire line
3.	Resistance of 2-wire line	$r - L$	0.0	0.0...20.0 $\Omega$	Only for resistance thermometer inputs
4.	Compensation of temperature cold junctions - for thermocouples	$Co n P$	$R u t o$	$R u t o$ 0.0...50.0 $^{\circ}C$	- automatic compensation - temperature of cold junctions $R u t o = -0.1$ or 50.1,
5.	Number of digits after the decimal point - concerns, measured values.	$L c P P$	0	0,1,2	0- without decimal-coded digit 1-with one digit after the decimal point 2- with two digits after the decimal point (only for linear inputs)
6.	Shift of measured value on the main input	$Sh, F$	0	-999...999 <sup>1)</sup>	Parameter added to the measured value - compensation of the temperature difference between the sensor and the object.

It.	Parameter name	Symbol on the display	Manufacturer setting	Range of changes	Explanations
7.	Lower range of the set value or measured value on the main input.	<i>SPL L</i>	-200	-999... ... <i>SPL H</i> <sup>1)</sup>	For linear inputs, <i>SPL L</i> and <i>SPL H</i> parameters allow to display measured values in physical units i.e., the <i>SPL H</i> value corresponds to the lower input range, e.g. to the 0 mA value, however, the <i>SPL H</i> value corresponds to the upper range, e.g. 20mA. For resistance thermometer inputs, <i>SPL L</i> and <i>SPL H</i> parameters limit the range of the set value.
8.	Upper range - as above	<i>SPL H</i>	850	<i>SPL L</i> ... ...9999 <sup>1)</sup>	
9.	Measuring range of the additional input	<i>INP2</i>	0-20 0-10 100	0-20 4-20 0-10 0-05 100 1000	0-20 mA for current input 4-20 mA for current input 0-10V for voltage input 0-5V for voltage input 0...100Ω for potentiometer input 0...1000Ω for potentiometer input
10.	Value corresponding to the lower measuring range of the additional input.	<i>ZL0</i>	0.0	-999... ... <i>ZH</i> <sup>1)</sup>	These parameters allow to display the measured quantity on the additional input in physical units.
11.	Value corresponding to the upper measuring range of the additional input.	<i>ZH</i>	100.0	<i>ZL0</i> ... ... 9999 <sup>1)</sup>	
12.	Function of the additional input.	<i>F, n2</i>	<i>INF0</i>	<i>SP</i> <sup>7)</sup> <i>INF0</i> <i>Rnd</i> <i>d, FF</i> <i>SrEd</i>	<ul style="list-style-type: none"> <li>- Set value (<i>rSP = INP2</i>)</li> <li>- Additional information</li> <li>- measurement = sum of signals from the both inputs</li> <li>- Controlled value = difference of signals from the main input and additional input</li> <li>- Controlled value = arithmetic mean of the both inputs</li> </ul>

It.	Parameter name	Symbol on the display	Manufacturer setting	Range of changes	Explanations
13.	Function of the binary input	$F_1, nb$	OFF	OFF STOP  hRnd End bLoh	No used binary input Stop the control (control signal = 0)  End of the programme. Stopping of the programme on the last calculated set value.
14.	Ranges of continuous outputs	ouc 1 ouc 2	0-20	0-20 4-20 0-10 0-05	0-20 mA for current outputs 4-20 mA for current outputs 0-10 V for voltage outputs 0-5 V for voltage outputs
15.	Output functions	out 1 out 2 out 3  out 4	Y 1 Rh, RLo  Err 1	OFF Y 1 Y2-c <sup>2</sup> )  Y2-S <sup>2</sup> ) Rh, RLo dbh, dbLo dbhL db, n Rh, i  RLo i Rh, 2 RLo 2 Eout EoP Err i Err 2 tr, i tr, 2 trSP	No used output Control signal of channel I Cooling (heating-cooling control)  Closing (three-state, step-by-step control ) absolute upper alarm absolute lower alarm relative upper alarm relative lower alarm external relative alarm relative internal alarm absolute upper alarm from main input absolute lower alarm from main input absolute upper alarm from additional input absolute lower alarm from additional input binary channel used in programmed control signalling of the program end signalling of failures of the main input signalling of failures of the input additional retransmission of the measured value from the main input retransmission of the measured value from the additional input retransmission of the set value

It.	Parameter name	Symbol on the display	Manufacturer setting	Range of changes	Explanations
16.	Bargraph functions	$\delta R r 1$ $\delta R r 2$	$\xi 1$ $5P$	$Y 1$ $Y 2$ $\xi 1$ $\xi 2$ $5P$	Control signal Y1 0...100% Control signal Y2 0...100% Measured value from the main input <sup>3)</sup> Measured value from the additional input <sup>4)</sup> Set point <sup>5)</sup>
17.	Controller address in the network	$R d r E$	0 <sup>5)</sup>	0...247	For executions with interface
18.	Baud rate in bit/s	$\delta R u d$	9600 <sup>5)</sup>	2400 4800 9600	
19.	Interface working mode	$\xi r Y b$	$o F F$ <sup>5)</sup>	$o F F$ $R 7 E 1$ $R 7 o 1$ $r 8 n 2$ $r 8 E 1$ $r 8 o 1$ $r 8 n 1$	Off - transmission blocked $R 8 n 1$ - A- ASCII mode r - RTU mode 8 or 7 bits of data E - parity check o - odd parity check n- lack of parity check 1 or 2 stop bits
20.	Algorithm of setting choice	$R u t o$	$o F F$	$o F F$ $i d E n$ $o 5 c Y$	Algorithm switched off Method of object identification Oscillation method
21.	Continuation of constant valued control after a supply decay	$c o n t$	$o F F$	$o F F$  $o n$	Control switching off after switching the supply on <sup>6)</sup> Control switching on after switching the supply on <sup>6)</sup>
22.	Safety code for the configuration	$5 E c c$	0000	0000... ...9999	When $5 E c c > 0000$ , then the application of its value during the parameter change is required.



1) The range and the parameter format are depending on the  $\xi c P P$  parameter - number of digits after the decimal point.



2)  $Y 2 - c$  and  $Y 2 - S$  outputs exclude themselves reciprocally, because algorithm of the three-state heating-cooling control and three-state step-by-step control can not be realised simultaneously.

3) The value is displayed in the  $5 P L \xi \dots 5 P L H$  range, i.e. 0% of lighted bargraph segments corresponds to values lower and equal to  $5 P L \xi$ , 100% of lighted bargraph segments corresponds to values higher and equal  $5 P L H$  ( 21 lighted bargraph segments ).

4) The value is displayed in the range  $i 2 L o \dots i 2 H i$ .

5) Parameters are not changed after calling the function "Return to the Manufacturer settings"

6) One can renew the stopped control by pressing simultaneously  i  keys.

The control can be stopped by pressing simultaneously  and  keys.

7) When the  $r 5 P$  parameter is set on  $i n P 2$  then  $F i n 2$  assumes the  $5 P$  setting and does not submitted to change.

It.	Parameter name	Symbol on the display	Manufacturer setting	Range of changes	Explanations
1.	PID parameters for the line I	$PRr$ $P, d^2$			
1.1	Proportional band of the line I	$Pb$	10.0	0..999.9%	Defines the interval below the set value, in % of the measuring range, in which the control signal is proportional to the control deviation. When $Pb = 0$ , the ON/OFF type of control is chosen.
1.2	Integration time constant of the line I	$t_i$	300	0...3600 s	Time necessary to double the signal issuing from the proportional part. When $t_i = 0$ , the integration element is switched off.
1.3	Differentiation time	$t_d$	60	0...1000 s	Time necessary to equalize the signal issuing from the proportional part with the signal issuing from the differentiating element; When $t_d=0$ the differentiating element is switched off.
1.4	Correction of the control signal for $t_i=0$	$y - of$	0.0	0.0...100%	For the control of P or Pd type (the integration time -constant $t_i=0$ ) the value added to the control signal in order to compensate the control constant deviation.
1.5	Pulse repetition period of the line I	$t_o$	20	1...250 s	Period in which the time of the control output I action is proportional to the control value. Only for discontinuous outputs.

It.	Parameter name	Symbol on the display	Manufacturer setting	Range of changes	Explanations
1.6	Hysteresis of the line I	$H$	1.0	0...99.9 <sup>1)</sup>	Interval around the set value in which changes of the input quantity does not generate changes of the main output state. The parameter is active, when the control of ON/OFF type was chosen.
1.7	Kind of control in the line 1	$\xi YPr$	$100$	$100$ $d, r$	Reverse control Non-reverse control
2	PID parameters for the line II <sup>2)</sup>	$PRr$ $P, d, c$			Occurs when one of the output is set as cooling ( $Y2 - c$ )
2.1	Proportional band of the line II	$Pb - c$	10.0	0...999.9%	Defines the interval above the set value for cooling, in which the control signal is proportional to the control deviation. When $Pb - c = 0$ , then the ON/OFF type of control is chosen.
2.2	Integration time-constant of the line II	$t_i - c$	0	0...3600 s	As for $t_i$
2.3	Differentiation time-constant of the line II	$t_d - c$	0	0...1000 s	As for $t_d$
2.4	Hysteresis for the line II	$H_i - c$	1.0	0...99.9 <sup>1)</sup>	When the control in the line II is of ON/OFF type.
2.5	Pulse repetition period of the line II	$t_o - c$	20	1...250s	Explanations as for to $t_o$
3	Dead band	$Hn$	10.0	0...99.9 <sup>1)</sup>	For step-by-step control of the set value. For the three-state heating-cooling control, the parameter added to the set value for the line I defines the set value for the line II (cooling).



It.	Parameter name	Symbol on the display	Manufacturer setting	Range of changes	Explanations
4	Speed of set point changes, i.e. soft start for the constant-valued control	<i>PRC</i>	0	0...999.9 units/minute	Enables to a soft access from the present temperature to the set point after connecting the controller to the network or after changing the set point when it is equal 0, then the function is disabled.
5	Alarm parameters <sup>2)</sup>	<i>PRR</i> <i>RLC</i>			
5.1	Set value for the alarm	<i>XASP</i> x-output nr	<i>SPLH</i>	<i>SPLH</i> <sup>1)</sup>	Value generating the action of the alarm output.
5.2	Memory of the alarm	<i>XRH</i> x-output nr	1.0	0.0... 99.9 <sup>1)</sup>	Interval around xasp, in which changes of the input quantity does not create changes of the alarm state.
5.3	Alarm memory	<i>XRR</i> x-output nr	<i>OFF</i>	<i>OFF</i> <i>ON</i>	Alarm memory switched off Alarm memory switched on
6	Kind of set point	<i>rSP</i>	<i>CON</i>	<i>CON</i> <i>PROGRAM</i> <i>INPT</i>	Constant - valued Programmed With auxiliary input
7	Security code	<i>SECP</i>	0	0...9999	

## Definition of set point programs

Table 4

It.	Parameter name	Symbol on the display	Manufacturer setting	Range of changes	Explanations
1	Number of the defined program	<i>nrPd</i>	1	1...15	Review or definition of the shown set point program
2	Number of program cycles	<i>LCYC</i>	1	1...99	Number of program repetitions
3	Value of the control deviation blocking the set point counting	<i>BLDH</i>	0	0...999 <sup>1)</sup>	Value of control deviation over which the counting of set point is stopped. When the parameter is 0, then the blocking is inactive.

It.	Parameter name	Symbol on the display	Manufacturer setting	Range of changes	Explanations
4	Index to continue the program after the supply return	<i>cont</i>	<i>off</i>	<i>off</i> <i>on</i>	Stop the program Continue the program
5	Speed of set point changes	<i>nRxx</i>	0	0,0...999,9 unit/min	Accretion rate od descent rate of set point. When parameter = 0, then the set point is constant in the segment. (stop). xx - number of the segment 1...15
6	Set point at the end of the segment	<i>SPxx</i>	0	<i>SPLh</i>	For segments, in which the parameter <i>nRxx</i> is different from 0, the in-coming set point - at the segment end.
7	Segment duration	<i>t xxx</i>	0	0...999 min	Segment duration with a constant set point (for segments in which the parameter <i>nRxx</i> is equal 0) Caution ! Both parameters <i>nRxx</i> and <i>t xx</i> equal 0 means the end of the program.
8	Binary output state k in the segment xx, k k=1...4 - number of the output configured as <i>EOvt</i>	<i>EOxx</i>	<i>off</i>	<i>on...off</i>	State of output k connection in the segment xx <i>on</i> - active blocking <i>off</i> - inactive blocking
9	Index of blocking in the segment xx	<i>bl xx</i>	<i>on...off</i>	<i>on...off</i>	Index of blocking activity in the segment xx <i>on</i> - active blocking <i>off</i> - inactive blocking

<sup>1)</sup> The range and parameter format depend on the parameter *LCPP* - the number of digits after the decimal point.

<sup>2)</sup> Press the  push-button to enter into the menu.

## 5.2. Kinds of alarms

During the output configuration (parameters  $o\text{u}\text{t } 1 \dots o\text{u}\text{t } 4$ ), one must define which of outputs operates as alarms, and alarm types. The value of alarm operation on the output  $x$  is given in the parameter  $xRSP$  (fig. 7).

The  $xRSP$  value means :

- for absolute alarms  $Rh_1$  and  $RLo$  - value of controlled signal
- for absolute alarms  $Rh_1$  and  $RLo_1$  - value measured on the main input.
- for absolute alarms  $Rh_2$  and  $RLo_2$  - value measured on the additional input.
- for relative alarms  $dbh_1$ ,  $dblo$ ,  $dbhL$  and  $dbi_n$  - value of the control deviation.

The drawings below describe alarm types:

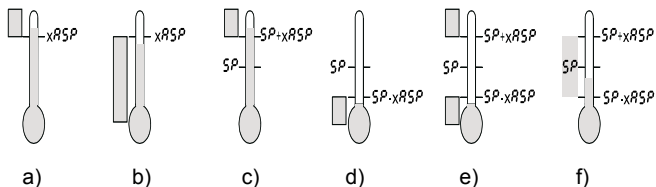

**Fig.7. Kind of alarms**

- a) absolute upper  $Rh_1$
- b) absolute lower  $RLo$
- c) relative upper  $dbh_1$
- d) relative lower  $dblo$
- e) relative external  $dbhL$
- f) relative internal  $dbi_n$

$SP$ - set point

$xRSP$  - set point on the output  $x$

### 5.3. Pulse repetition rate

The pulse repetition period is the time which expires between successive switchings of the discontinuous output during the proportional control. The length of the pulse repetition period can be chosen depending on the dynamic properties of the object and appropriate to the output device. For fast processes, it is recommended to use SSR relay or a continuous output. The relay output is used for steering contactors in slow-changing processes. The use of long pulse repetition periods for steering high-frequency processes can give undesirable effects in the shape of oscillations. In theory, smaller the pulse repetition period, better the control is, however for the relay output it should be as high as possible in order to prolong the relay life.

Recommendations concerning the pulse repetition period.

Table 4

Output device (output 1 or output 2)	Pulse repetition period ( $t_0$ or $t_0 - c$ )	Load (resistance)
elektromagnetic relay	Recommended >20 s min. 10 s	2 A/250 V AC or contactor
	min. 5 s	1 A/250 V AC
transistor output	1...3 s	Solid-state relay (SSR)

### 5.4. Additional input.

In the controller, which is equipped with an additional input, one must set parameters:

$rSP$ ,  $zL_0$ ,  $zH$ , and  $F_{in}$  defining the input type, measuring range and the function (see table 2). This input can fulfil following functions:

- Source of remote set point ( $rSP = rSP$ ), then  $F_{in} = SP$  and do not be subject to changes, only the set  $rSP$  on the  $CON$  or  $PROG$  allows the selection of remaining functions.
- The additional measurement  $F_{in} = rF_0$ , e.g. information about the valve opening state. The measured value on this place and recalculated on the range ( $zL_0 \dots zH$ ) is displayed on the lower display, preceded by the symbol  $\omega$ .

- As the component of the controlled signal:

- $F_{WR} = R_1 + I_2$ , the controlled value = sum of signals from both inputs  
 $WR = I_1 + I_2$
- $F_{WR} = I_1 - I_2$ , the controlled value = difference of signals from the main input and additional input.  
 $WR = I_1 - I_2$
- $F_{WR} = (I_1 + I_2)/2$ , the controlled value = arithmetic mean from both inputs  
 $WR = (I_1 + I_2)/2$

in this case, there is the controlled signal  $WR$  on the upper display, and individual measurements are displayed on the lower display preceded by symbols:

$R$  - measurement on the input 1

$u$  - measurement on the additional input.

## 5.5. Binary input

The binary input is used according to the parameter setting  $F_{iob}$ , where:

- $StoP$  - disabling of control outputs and relative alarms,
- $hRnD$  - impuls switching on the manual operation,
- $EnD$  - end of the program and return to its beginning,
- $blOh$  - stop of set point counting and the control follows acc. to the last calculated value.

For  $StoP$  and  $blOh$  the above action is carried out, when the binary input is shorted ( $on$ ).

The input opening ( $oFF$ ) causes the controller return for the operation mode.

For  $hRnD$ , the state switching from  $oFF$  to on produces the entry of the control output

( $Y$  function) into the manual control. The next switching from  $oFF$  to on produces the return to the automatic control.

For  $EnD$ , the state switching from  $oFF$  to  $on$  produces the end of the program, and the state switching from  $on$  to  $oFF$  causes the program start from the beginning.

## 5.6. Three-state control

The three-state control is used during heating and cooling. One must set the parameter  $\sigma u \xi k$  on the value  $Y^2 - c$  and set the zone of the channel separation  $H_n$ . The second line operates for the set value equal  $SP + H_n$  as a non-reverse controller. One must define parameters  $P_{b-c}$ ,  $t_{1-c}$ ,  $t_{d-c}$ ,  $H_{1-c}$ ,  $t_{o-c}$  in accordance to the table 3. The operation of a three-state controller with the algorithm of P type is shown on the fig.8.

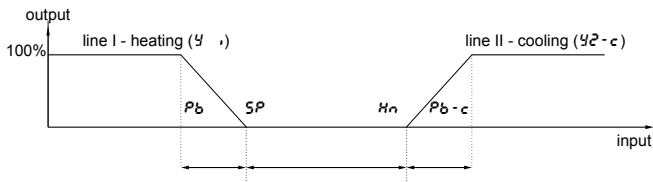
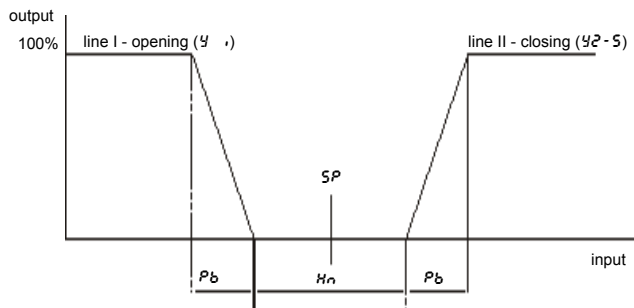

**Fig.8. Three-state heating-cooling control**

## 5.7. Three-state step-by-step control

The three-state step-by-step control is used to control a valve. One must set the  $\sigma u \xi k'$  parameter on the value  $Y^2 - S$  and set the dead-band around the set value  $H_n$ . The first line - opening the valve - operates for the set value equal  $SP - H_n / 2$  as a reverse controller, the second line - closing the valve - operates for the set value equal  $SP + H_n / 2$  as a non-reverse controller. PID parameters for the second line are the same as for the first line.

For the step-by-step control a control of PD type is recommended. The operation of a three-state step-by-step controller with an algorithm of P type is shown on the drawing 9.







**Fig.9. Three-state step-by-step control**

## 5.8 Security code

$SECP$  parameters - for configuration parameters and  $SECP$  for working parameters of the controller - allow to secure the controller against the interference of incompetent persons. The security codes are switched off by the Manufacturer, i.e. they are equal 0. After setting all necessary parameters and after checking the correctness of the controller operation, one can set the security codes. After setting the code, the change of parameters is preceded by the necessity to give its value. Only the change of the set value is directly accessible. In order to change the security code, one must give the hitherto existing  $SECP$  value, and next, introduce the new  $SECP$ . If an incorrect code has been given, the  $ERR$  inscription is displayed till the moment of pressing any optional key.

## 6. SPECIAL FUNCTIONS



### 6.1. Calling of special functions

One must hold during 3 s the  key (see Fig. 5 - entry into the mode IV), and then by means of  and  keys select the appropriate function. The return to the mode I follows after pressing .

### 6.2. Manual control

The manual control is useful during setting to work the control on the object and for identification the object parameters. One can manually control any optional input by calling the  $5kEk$  function (mode IV), where  $k$  means the output number. The measured value is shown on the upper display, and on the lower display, depending on the kind of output:



**- for a two-state control (output  $k$  as  $41$  or  $42-c$ )**

The value of the output signal is flashing on the lower display, and one can change it by means of  or  key in the range 0.0...100%.

**- for the alarm or signalling device**

The turning-on ( $o\pi$ ) or turning-off state ( $oFF$ ) of the outputure on the lower display.

**- for step-by-step control**

The valve opening is carried out during the  key, holding, the valve turn-off is carried out during the  key holding. The valve state is given on the lower display:  $oPE\pi$ - turn-on,  $c\iota oS$ - turn-off,  $5\epsilon oP$  - valve stop. The return to the automatic work follows after pressing the  key.



### 6.3. Selection of PID controller settings

The *AdRP* function appears on the list of special functions when the *RuLo* parameter (mode II) is set on the value *idEn* or *oScY*. The change of lower display displays from *oFF* on *oN* calls the algorithm of automatic selection of PID control settings.

### 6.4. Measurement of a two-wire line resistance

In controllers with resistance thermometer sensors connected by a two-wire line one should introduce the line resistance value - ( parameters 2 and 3 in the table 2), or measure in accordance to the following procedure: shorten the sensor terminals, entry into the mode IV and call the *rLi* function, the measured resistance value is flashing on the lower display. After the value stabilisation, accept it by the  key. A lead resistance higher than 20  $\Omega$  will not be accepted.

### 6.5. Return to the producer settings

Producer setting can be restored after entering into the mode IV, calling the *rFRb* function and accepting the value *oN*.

The function does not change the input type.

#### **Attention !**

The function reduces all program data to zero.

## 7. THE PROGRAMMED CONTROL

### 7.1. Defining programs of set value

When the  $rSP$  parameter is set on  $PROG$ , the controller control the object according to the set point changing in time values in accordance with the assigned programme, One can define 15 programmes.

The maximal number of section in the programme is 15.

For each programme one can give:

- the number of repetition  $LCYC$
- the control deviation value  $BLDH$ , over which the counting of the set point value is stopped (the object does not follow - the set point value is changing too rapidly).
- the marking of programme continuation after supply recovery  $CONT$

The section is defined by following parameters:

- $NRXX$  - speed rate of the set point, where xx means the section number; the parameter value 0 means that the set point on this section is constant.
- $SPXX$  - the incoming set point for segments with a variable set point
- $txx$  - segment duration for a section with a constant set point  $NRXX=0$
- $EOXX$  - state of the auxiliary output (only when  $OUTK$  in set on  $EOUt$ ) - the on value means a turned on output, the off value means a turned off output.
- $BLXX$  - activity mark of the programmer deadlock from the control deviation - the  $ON$  value means a turned on deadlock, the  $OFF$  value means a turned off deadlock.

The Fig. 10 and the table 6 present an exemplary set point programme. It is admitted in this programme that the temperature in this object is to increase from the initial temperature in the object till 800°C with a speed of 20°C /min. with an active deadlock from deviation. Then, during two hours (120 min.) this temperature is maintained (deadlock turned off), after that this temperature is to decrease till 50°C (deadlock turned off), during the precooling of the object one can turn on the cooling fan connected to the auxiliary output nr 3 (parameter `out 3` set on `εout`).

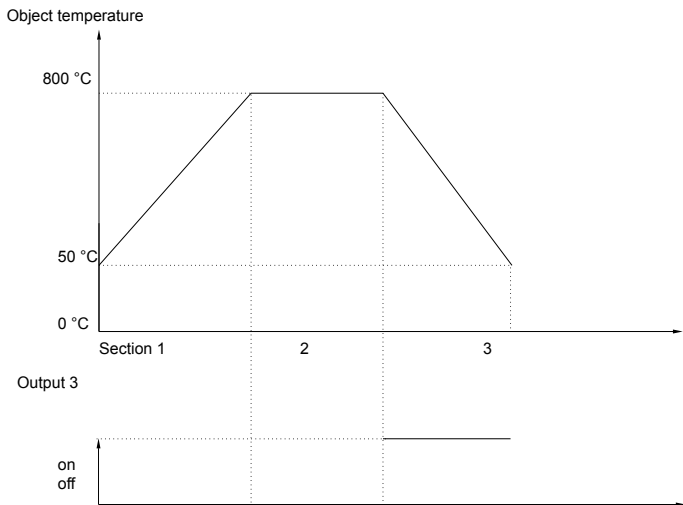



**Fig.10. Set point program**



Parameter	Value	Signification
ЛсУс	1	Number of program repetitions
бЛох	50.0	Deadlock turned on when the control deviation exceeds 50.0°C
Сонт	он	Continue the program after the supply recovery
нР 1	20	The accretion of the set point in section 1 is 20°C/min.
SP 1	800	Set point at the end of the section 1 - in-coming
Ео 1	3оFF	The output 3 in section 1 is turned off
бЛ 1	он	The deadlock in section 1 is active
нР 2	0	Holding down of the set point in the section
т 2	120	Holding down time of the set point
Ео 2	3оFF	The output 3 in the section 2 is turned off
бЛ 2	оFF	The deadlock in the section 2 is inactive
нР 3	40	The abatement of the set point in section 3 is 40°C/min.
SP 3	50	Set point in the section 2 - in-coming
Ео 3	3 он	The output 3 in section 3 is turned on
бЛ 3	оFF	The deadlock in the section 3 is inactive
нР 4	0	End of the program - the accretion and holding time are equal 0
т, 4	0	



## 7.2. Control by a set point program

Before starting the control with a variable set point one must choose the program - parameter  $нР Pr$ . The flashing point in the right corner of the lower display means that the programmed control lasts. During the program duration one can display parameters of the realised program on the lower display, i.e. the number of the operating section  $н xx$ , the time which remains to the end of the section  $т xxx$  (in minutes), and the number of cycles which remains to execute  $Л xx$ .

Pressing simultaneously two push-buttons one can:

 and  - start the selected program from the beginning,

 and  - stop the realized program (the controlled output is disabled, the set point counting is stopped, the dot is go out). The stopped program can be renewed.

 and  - transit to the next segment.

After ending the program, the dot is go out and outputs are disabled or the program is renewed, if the number of the  $LCY$  is higher than 1.

When the  $blsh$  parameter (blocking in the program) is higher than 0 and the deadlock index  $bl$  in the operating segment is active ( $on$ ), then the control deviation quantity is controlled (set point - measured value). If the current deviation is higher than the deadlock value, then the set point counting is stopped, and the dot is lighted continuously - the controller controls to the lately counted set point, as long as the control deviation does not drop below the dead lock value.

## 8. CHOICE OF PID CONTROLLER SETTINGS

### 8.1 Self-adaption

Two self-adaptation methods are applied in the controller for the constant-valued control.

During the controller configuration (mode II), one must choose the method, setting the  $RUE$  parameter:

- $OFF$  means, that the selection function of PID parameters is inaccessible,
- $dEn$  means, that PID parameters will be calculated on the base of the inert object (fig 11),
- $OCY$  means, that PID parameters will be calculated on the base of oscillations around the set point (see fig.12). The oscillation method must be chosen only when overshots over the set point do not cause damages of the charge and object.

The calling of self-adaptation follows in the special function mode (mode IV) through the change of the lower display value from  $OFF$

to 0 for the function *AdAP*. For programmed control, the *AdAP* function is inaccessible.

The flickering upper display informs about the activity of the self-adapting function. The duration time of the self-adapting control function depends on the object and can last up to 2 hours. Longer the delay, longer the time of setting choice is. After finishing the self-adapting control function new PID settings are automatically memorised into the nonvolatile memory of the controller. For step-by-step control - the *OUTk* parameter is set on *42-5* the integrating element is switched off (parameter *t<sub>i</sub>* = 0).

The self-adapting process can be broken, without the calculation PID settings, if:

- the set value is too near of the measured value, i.e. the control deviation is smaller than 5% of the range (for the *AdAP* method)
- the accessible heating power is too small to reach the set value;
- the key  has been pressed.



When changing manually settings one must introduce the change of only one parameter and observe come into being effects.

When changing PID parameters one must run in accordance of the following principles:

- **free answer of the object:** decrease the proportional band, the integration time-constant, the differentiation time-constant;
- **over-control:** increase the proportional bad and the differentiation time-constant;
- **oscillations:** increase the proportional band and the integration time-constant, decrease the differentiation time-constant;
- **instability:** increase the integration time-constant.

It is recommended that the integration time-constant was at least five times higher than the differentiation time-constant.

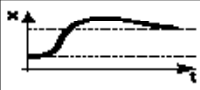
Symptoms of a wrong choice of PID settings and recommended corrections.

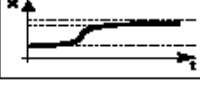
Course of the controlled quantity	Algorithms of the controller action			
	<b>P</b>	<b>PD</b>	<b>PI</b>	<b>PID</b>
	$Pb \uparrow$	$Pb \uparrow \quad t_d \downarrow$	$Pb \uparrow$	$Pb \uparrow \quad t_d \downarrow$
	$Pb \uparrow$	$Pb \uparrow \quad t_d \uparrow$	$Pb \uparrow \quad t_i \uparrow$	$Pb \uparrow \quad t_d \uparrow \quad t_i \uparrow$
		$Pb \downarrow \quad t_d \downarrow$		$Pb \downarrow \quad t_d \downarrow \quad t_i \downarrow$
	$Pb \downarrow$	$Pb \downarrow$	$t_i \downarrow$	$Pb \downarrow \quad t_i \downarrow$

## 8.2. Manual choice of PID settings.

a) method of the object identification

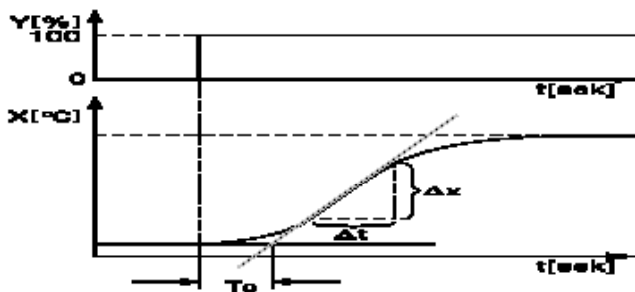

*Fig.11. Characteristic of the inertial object after switching the Y control signal on.*

From the object characteristic presenting the controlled quantity in function of the time, one must read out the object delay time  $T_0$  and the maximal accretion rate of the temperature from the dependence  $V_{\max} = \frac{\Delta x_{\max}}{\Delta t}$ . The controller PID settings can be calculated according to given formulas:

$$X_p = 1.1 * V_{\max} * T_0 \quad \text{- proportional band}$$

$$t_i = 2.4 * T_0 \quad \text{- integration time-constant}$$

$$t_d = 0.4 * T_0 \quad \text{- differentiation time constant}$$

b) oscillation method

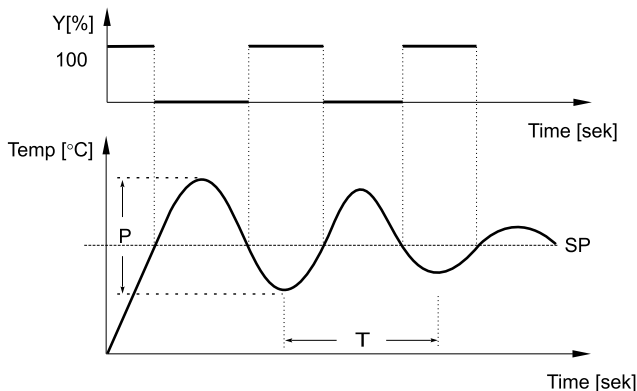

**Fig.12. Choice of settings through the oscillation method.**

Calculate controller PID settings in accordance with the given formulas:

$$X_p = P \quad \text{- proportional band}$$

$$t_i = T \quad \text{- integration time constant}$$

$$t_d = T/4 \quad \text{- differentiation time-constant}$$



## 9. TECHNICAL DATA

<b>Input signals</b>	The controller has a universal input with the possibility to connect any input signal as resistance, termoelectric power, voltage or current. The kind and the range of the input signal are chosen by the program from the table 8.
<b>Basic error of the real value measurement</b>	0.2% (0.3% for B,R and S thermocouples)
<b>Sampling period</b>	0.5 s
<b>Control algorithm</b>	ON/OFF with hysteresis, PID, with auto-adaptation
<b>Ranges of controller parameter settings:</b>	see tables 2 and 3
<b>Action way of outputs:</b>	
- reverse (for heating) ( <i>нв</i> )	
- direct (for cooling) ( <i>дв</i> )	
- analogous, linear voltage or current linear output	
- logic, with a proportional cycle time	
- heating-cooling or cooling-cooling	
- three-state heating-cooling or cooling-cooling	
- three-state step-by- step for closing/opening the valve	
<b>Kinds of setpoint:</b>	
- constant (standard) ( <i>const</i> )	
- ramp/soak programmed ( <i>Prsg</i> )	
- from the auxiliary input ( <i>inp2</i> )	
<b>Number of programs</b>	15
<b>Number of segments in the program</b>	1...15
<b>Duration time of a segment</b>	1...999 min
<b>Set point change rate</b>	0.0...999.9 units/min
<b>Number of program repetitions</b>	1...99

### Kinds of outputs:

- relay electromagnetic relays contact load: 220 V, 2 A  
 $\cos\varphi = 0.4$ ,  $S = 440 \text{ VA}$
- transistor OC type,  $U_{\max} = 24 \text{ V}$   
 $I_{\max} = 10 \text{ mA}$
- transistor voltage 0/19 V,  $I_{\max} = 20 \text{ mA}$
- analogue voltage 0...5 V, 0...10 V,  $R_{\text{load}} \geq 500 \Omega$
- analogue current  $R_{\text{load}} \leq 500 \Omega$

### Accuracy of analogue outputs

0.2%

### RS-485 serial interface:

- baud rate 9600, 4800, 2400 bit/s
- transmission protocol MODBUS
- Modes ASCII: 8N1, 7E1, 7O1  
RTU: 8N2, 8E1, 8O1, 8N2

### Reference and rated service conditions:

- supply voltage: 90...230...254 V a.c./d.c.  
or 20...24...40 V a.c./d.c
- supply voltage frequency 48...50...68 Hz
- ambient temperature 5...23...40 °C
- relative humidity 25...85 %
- external magnetic field < 400 A/m.
- work position any
- resistance of leads connecting the RTD to the controller < 10  $\Omega$ /lead

### Protection level ensuring by the housing acc, to EN 60529

- from the faceplate IP 40
- from terminals IP 20

**Additional errors caused  
in rated service  
conditions caused by:**

- lead resistance change  
in a three-wire line < 0.2 %
- compensation of the  
thermocouple cold junction  
temperature < 2°C
- ambient temperature change < 0.2%/ 10 K

**Safety requirements acc. to EN 61010-1**

- isolation basic
- installation category III
- pollution level 2

**Electromagnetic compatibility:**

- immunity EN 61000-6-2
- emission EN 61000-6-4

**Overall dimensions** 48 x 96 x 93 mm

**Weight** 300 g

Sensor types	Designation	Range	Symbol on the display
<b>Universal input</b>			
Pt100 acc. EN 60751+A2:1997	Pt100	-200...850°C	$Pt$ ,
Pt1000 acc. EN 60751+A2:1997	Pt1000	-200...850°C	$Pt$ ,0
Ni100/1.617	Ni100	-60...180°C	$n$ ,1
Cu100/1.426	Cu100	-50...180°C	$Cu$ ,
Fe-CuNi	J	-100...1200°C	$t$ - ,
Cu-CuNi	T	-100...400°C	$t$ - $t$
NiCr-NiAl	K	-100...1370°C	$t$ - $H$
PtRh10-Pt	S	-50...1760°C	$t$ -5
PtRh13-Pt	R	-50...1760°C	$t$ - $r$
PtRh30-PtRh6	B	300...1800°C	$t$ - $b$
NiCr-CuNi	E	-100...1000°C	$t$ - $E$
NiCrSi-NiSi	N	-100...1300°C	$t$ - $n$
Chromel-kopel		0...800°C	$t$ - $ch$
Resistance		0...400 $\Omega$	$r$ - $rr$
Linear current	I	0...20, 4...20 mA	0-20, 4-20
Linear voltage	U	0...5 V, 0...10 V	0-05, 0-10
<b>Auxiliary input</b>			
Linear current	I	0...20 mA, 4...20 mA	0-20, 4-20
Linear voltage	U	0...5 V, 0...10 V	0-05, 0-10
Linear potentiometric	r	0...100 $\Omega$ , 0...1000 $\Omega$	100, 1000
<b>Logic input</b>			
voltageless	b	shorted, opened contacts	$on$ $off$

### Coding examples

The code symbol: **RE15-1-1-4-1-1-00-8** means: a RE15 controller with a universal input, auxiliary input: 0/4...20 mA, with one analogue output 0/4...20 mA or 0...5/10 V and 3 relays, with a RS-485 serial interface and MODBUS protocol, supply voltage 90...230...254 V a.c./d.c., standard execution, without additional requirements.

## 10. ORDERING CODES

Table 9

RE15 CONTROLLER	X	X	X	X	X	XX	X
<b>Main input:</b>							
universal input for thermocouples, resistance thermometers, linear current 0/4...20 mA, linear voltage 0...5/10 V, logic input .....							1
on order .....							9
<b>Auxiliary input:</b>							
without input.....							0
current 0/4...20 mA .....							1
voltage 0...5/10 V.....							2
potentiometric transmitter 0...100 Ω .....							3
potentiometric transmitter 0...1000 Ω .....							4
on order .....							9
<b>Outputs:</b>							
4 relays, change-over contact.....							1
4 transistor OC.....							2
1 logic 0/19 V + 3 relays .....							3
1 analogue output + 3 relays .....							4
1 analogue output + 3 transistor OC .....							5
2 analogue outputs + 2 relays.....							6
2 analogue outputs + 2 transistor OC .....							7
on order .....							9
<b>RS-485 interface:</b>							
without interface.....							0
with the MODBUS protocol.....							1
<b>Supply voltage:</b>							
90...230...254 V a.c./d.c.....							1
20...24...40 V a.c./d.c.....							2
<b>Type of execution:</b>							
standard.....							00
custom-made*.....							99
<b>Additional requirements:</b>							
without additional requirements .....							8
with a quality certificate.....							7
acc. user's agreements** .....							X

\* The code symbol will be settled by the producer

\*\* After agreeing by the producer

## 11. MAINTENANCE AND GUARANTEE

**The RE15 controller does not required any periodical maintenance. In case of some incorrect unit operations:**

1. In the period defined in the guarantee card from the date of purchase:

One should take the meter down from the installation and return to the Manufacturer's Quality Control Dept. If the unit has been used in compliance with the instructions, manufacturer guaranties to repair it free of charge.

2. After the guarantee period:

One should turn over the unit to repair in a certified service workshop. The disassembling of the unit housing causes the cancellation of the granted guarantee. Spare parts are available for the period of 10 years from the date of purchase.

The Manufacturer's reserves the right to make changes in design and specifications of any products as engineering advances or necessity requires.



RE15-07D/1



Lubuskie Zakłady Aparatów Elektrycznych - LUMEL S.A.

ul. Sulechowska 1

65-022 Zielona Góra - Poland

Tel. (48-68) 329 51 00 (exchange)

Fax: (48-68) 329 51 01

e-mail: [lumel@lumel.com.pl](mailto:lumel@lumel.com.pl)

<http://www.lumel.com.pl>

**Export Department:**

Tel.: (48-68) 329 53 02, 329 53 04

Fax: (48-68) 325 40 91

e-mail: [export@lumel.com.pl](mailto:export@lumel.com.pl)