



BONUS:
 0-3 = 10
 4-6 = 14
 7-9 = 20
 10 CUPS
 (with 10000 pts)

HIGH SCORE - ALL TIME

BA	10 17	GP	9 51
BA	10 19	MK	9 52
JL	10 25	JB	9 53
A	10 26	ABA	8 30
	10 50	AG	8 54

BONUS:
 0-3 = 10
 4-6 = 14
 7-9 = 20
 10 CUPS
 (with 10000 pts)

HIGH SCORE - ALL TIME

B/JL	10 23
ABA	10 25
LT	10 50
A	9 28
GP	9 51

PLACE SERIAL NUMBER LABEL HERE



TABLE OF CONTENTS

FACTORY CONTACT INFORMATION	2
WELCOME TO: Sink It	4
HOW TO PLAY	5
SPECIFICATIONS	6
SAFETY PRECAUTIONS	6
QUICK SETUP GUIDE	7
HEAD TO HEAD CONNECTION	8-10
DIP SWITCH SETTINGS	11
MAIN MENU FUNCTIONS	12
CLEAR CREDITS	12
GAME SETUP	13
TICKET PATTERNS	14
DIAGNOSTICS MENU	15
LOCATION NAME & ADVERTISING	16
MACHINE SETUP- HEAD TO HEAD	17
MACHINE SETUP- SINGLE GAME	18
REPORTS- HEAD TO HEAD	19
REPORTS- SINGLE GAME	20
SOFTWARE UPDATE	21
MAINBOARD PINOUT	22-24
MINIGEN PINOUT	25
WIRING DIAGRAMS	26-30
TROUBLESHOOTING GUIDE	31-37
POWER SUPPLY DIAGNOSTICS	38
BILL ACCEPTOR DIAGNOSTICS	39
HOW TO: ACCESS MAINBOARD	40
HOW TO: REMOVE BALL SENSOR	41
HOW TO: REMOVE CUP ASSEMBLY	42
HOW TO: ACCESS CAMERA/ LIGHT	42
CREDIT CARD READER	43
PARTS LISTS	44-46
MAINTENANCE LOG	47
TECHNICAL SUPPORT	48
WARRANTY	49

WELCOME TO: Sink It!

Congratulations on your Sink It™ purchase!

A family-friendly twist on our original Beer Pong Master game, Sink It is the perfect addition to any ticket redemption game room.

The fun ball-tossing action and competitive nature of Sink It will have players lining up!

Please take a moment to read through this manual and be sure to contact our factory if you have any questions or would like some more information.

Thank you for your purchase! Your business is important to us and we hope you enjoy this game as much as we do!

Your Friends at Bay Tek Games



GAME INSPECTION

Inspect the game for any damaged, loose, or missing parts.

If damage is found, please contact your freight carrier first.

Then, contact Bay Tek Games' Service Department at 920.822.3951 or e-mail them at service@baytekgames.com for further assistance.

HOW TO PLAY

Insert credits and select 1- or 2-player with the buttons on the front of the games.
(Single games will not have the 2-player button)



Toss or bounce the balls into the cups, trying to hit all 10 cups and turn off the blue lights inside before your opponent!



Win tickets for your skills!















GAME SPECIFICATIONS

WEIGHT	
NET WEIGHT	475 LBS.
SHIP WEIGHT	525 LBS.
DIMENSIONS	
WIDTH	30"
DEPTH	71"
HEIGHT	77"
OPERATING TEMPERATURE	
FAHRENHEIT	80-100
CELSIUS	26.7-37.8

POWER REQUIREMENTS			
INPUT VOLTAGE RANGE	100 to 120 VAC	/	220 to 240 VAC
INPUT FREQUENCY RANGE	50 HZ	/	60 HZ

MAX START UP CURRENT	OPERATING CURRENT
1 AMPS @ 115 VAC	1.5 AMPS @ 115 VAC
0.5 AMPS @ 230 VAC	.75 AMPS @ 230 VAC

SAFETY PRECAUTIONS

 NOTICE 	
Modifications to the mechanical, electrical and structural components of this game may void its compliance certifications.	
 DANGER 	
DO NOT perform repairs or maintenance on this game with the power ON. Unplug the unit from the wall outlet or shut off the power strip located inside the cabinet.	
 WARNING 	
Use of flammable substances can cause sever burns or serious injury. Always use NON-FLAMMABLE solvents for cleaning. DO NOT use gasoline kerosene or thinners.	
 CAUTION 	
Lifting heavy objects can cause back, neck or other injuries. Be sure adequate lifting and moving devices are available when unloading, unpacking and moving this game.	
 ATTENTION 	
Be sure the electrical power matches the game requirements. See the serial number located on the back of the game cabinet. Always plug into a grounded circuit. If the supply cord is damaged, it must be replaced by an approved cord or assembly provided by the manufacturer.	
 IN CASE OF EMERGENCY 	
UNPLUG THE POWER CORD. The power cord must be accessible at all times in case of an emergency.	

QUICK SET UP GUIDE

Place the game near its final location. Open the storage compartment by unlocking the front metal and sliding the bounce platform forward.



Ensure the balls didn't bounce out of the trough during transport.

No more than **20 balls** should be in the machine at a time for proper function

Sink It uses **38-40 mm** ping pong balls



Plug the power cord (located in the storage compartment) into the game and a standard 110v outlet, then switch the power strip inside the front door to the on position.



The game may require a camera calibration after shipping. See page 15 for instructions.

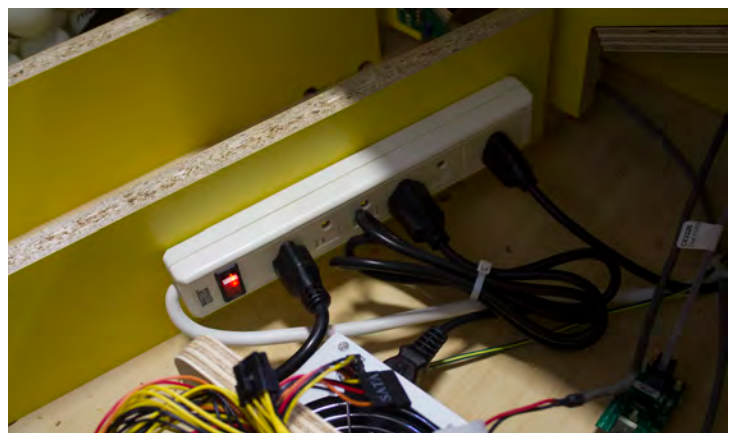

HEAD TO HEAD CONNECTION

Place two games next to each other and pull out the bounce platforms.



Locate the grey phone cables inside each compartment connected to the auxillary board shown. The boards are connected to the motherboard via USB.



Feed the cable through the hole in the back of the cabinet, and repeat in other cabinet

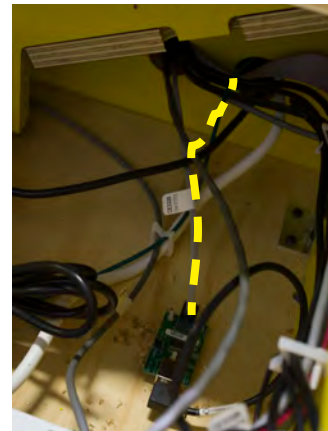

Plug the cables from each game into each other, then push the cabinets together.

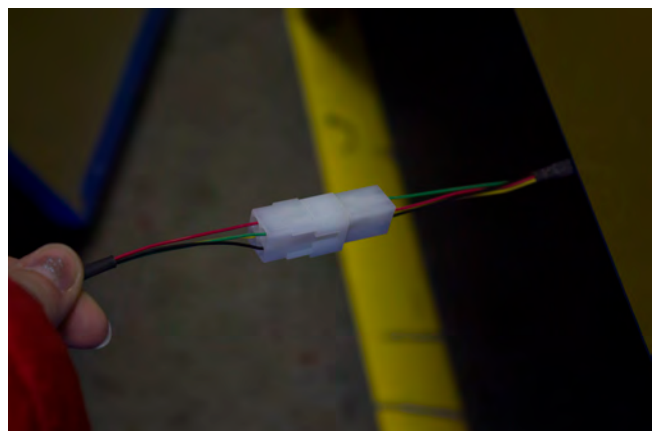

HEAD TO HEAD CONNECTION

Secure the cabinets together with included bolts, washers and locknuts.

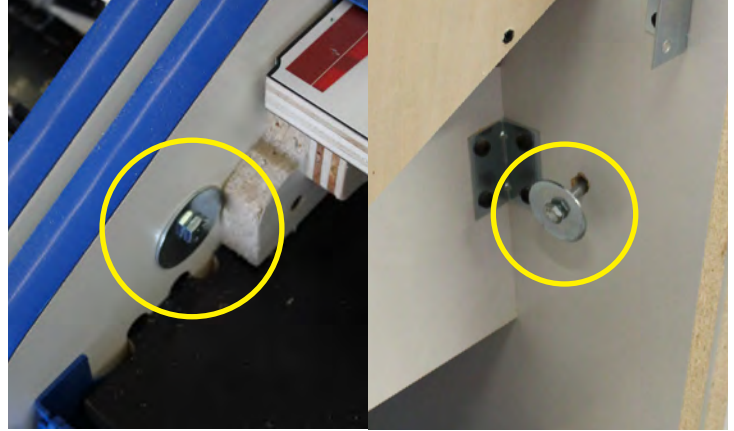

One set of holes is located inside the coin door of the left game and the ticket door of the right game.



The other set of holes is inside the back doors.

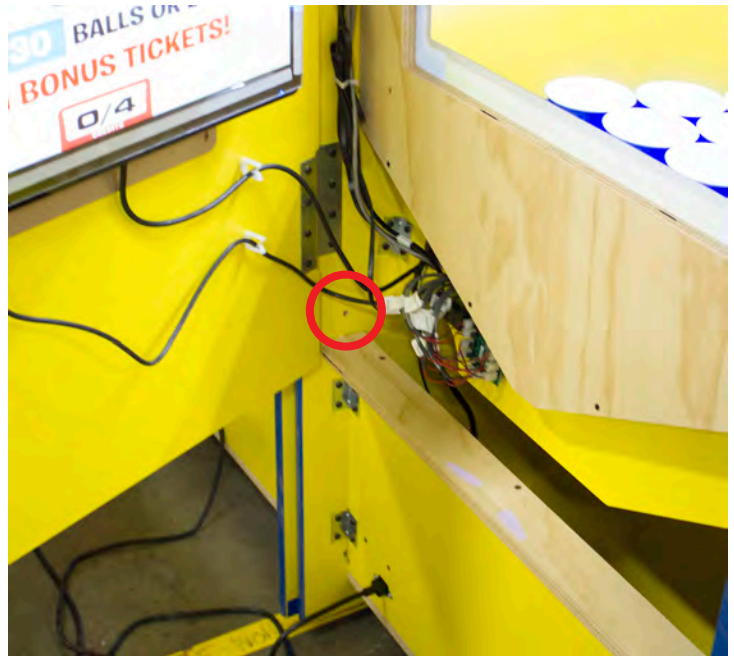

HEAD TO HEAD CONNECTION

Place the marquee on top of the two games, centering it between them.



Secure with included wood screws.

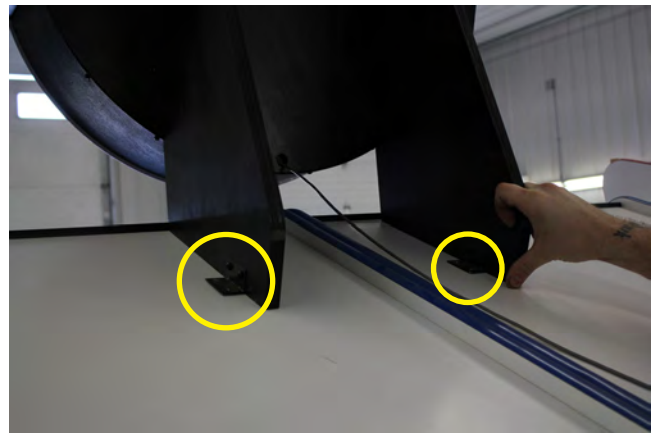

Run the cable down between the cabinets and plug in to housing near bottom of the right side game.

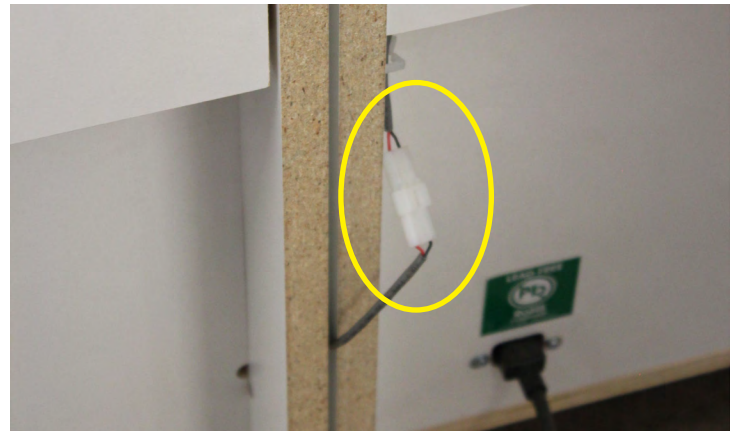

DIP SWITCH SETTINGS

The dip switch bank is located on the minigen board under the bouncing platform; open the front door, then slide the platform towards you.

*factory default settings are highlighted below

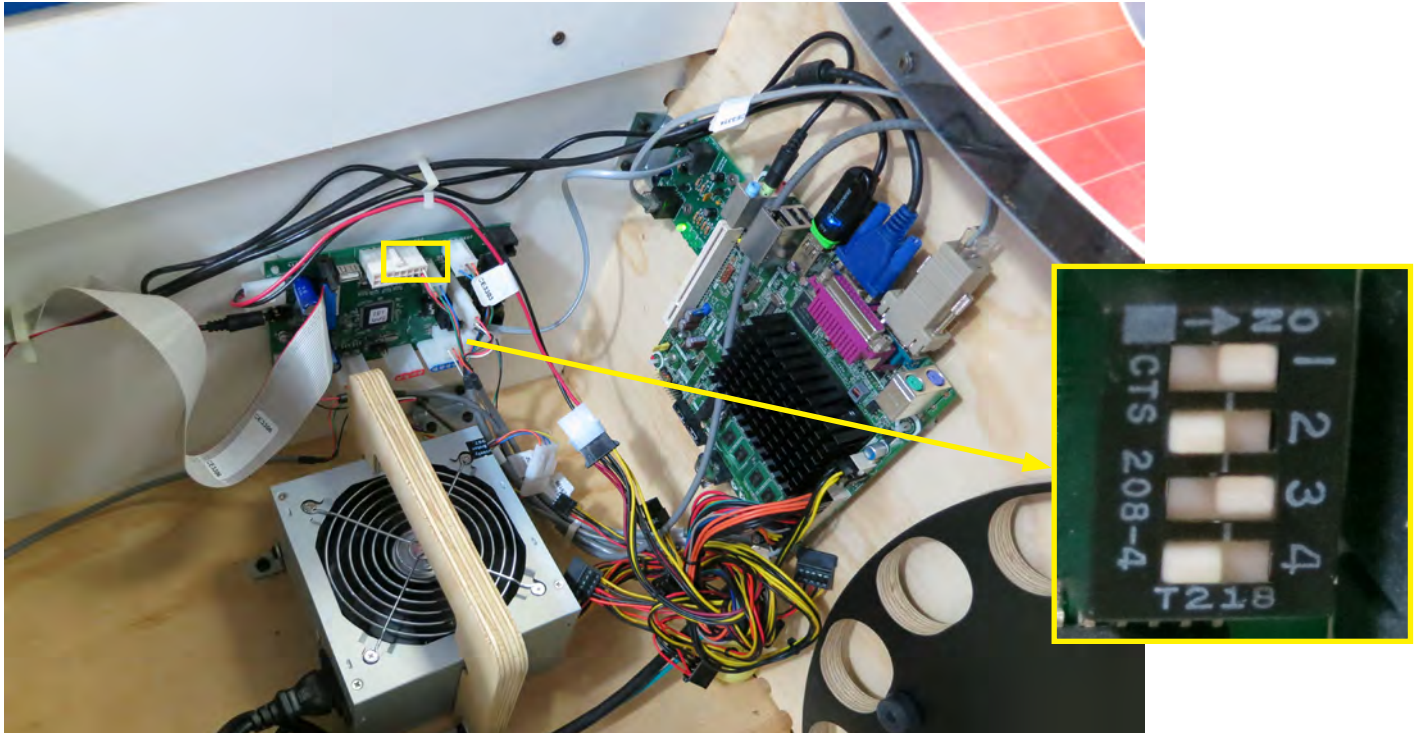

SWITCH	DESCRIPTION	OFF	ON
1	Enable Tickets		
2	New Jersey compliance		
3	Do Not Adjust		
4	Do Not Adjust		

MAIN MENU

Press the **MENU BUTTON** inside the front door to enter the main menu.

Scroll through the options by pressing the **MENU BUTTON** and make your selection with the **MENU SELECT** button.

The blue and red player buttons also scroll through the menus.



SINK IT Main Menu

Clear Credits & Tickets

Start Test Game after exit

Game Setup

Diagnostics Menu

Location Name and Advertising

Machine Setup

Reports

Software Update

Exit Menu

PC Software Version = 2.05.4

Minigen Software Version = 2.07

Camera Software Version = 1.23a

CLEAR CREDITS & TICKETS

Press MENU/SELECT when Clear Credits is highlighted to reset the available credits and tickets owed to 0.

START TEST GAME AFTER EXIT

Selecting this option will start a test game after exiting the menu.

CLEAR HIGH SCORES

Selecting this option will start clear the high scores screen.

GAME SETUP

SINK IT Game Setup

Coins/Credits per Play **4**

DBA \$1 Additional Games **0 Games**

DBA \$5 Additional Games **0 Games**

DBA \$10 Additional Games **0 Games**

DBA \$20 Additional Games **0 Games**

Credit Card Charge Games/Swipe **Off**

Credit Add Games/Swipe **0 Games**

Game Time **60 Sec**

Balls per Game **30 Balls**

Extra Last Ball Delay **After 10 Sec**

Ticket Payout Pattern **5**

CUPS 0-3 4-6 7-9 All 10

TICKETS 10 14 20 32 + balls left

Divide Ticket Payout by 2 **Off**

Exit Menu

SETTINGS OPTIONS & FACTORY DEFAULTS									
Credits per Play	0	1	2	3	4	5	6	7	8
DBA Additional Games	Gives additional games for \$ bill denominations (default is 0-off)								
CC Charge Games/Swipe	OFF				ON				
CC Add Games/Swipe	0	1	2	3	4	5	6	7	8
Game Time (seconds)	30	60	90	120	150	180			
Balls Per Game	10	20	30	40	50	60			
Extra Last Ball Delay (seconds)	never		10	15	20	25	30		
Ticket Patterns	see next page								
Divide Tickets by 2	OFF				ON (pays out 1 paper ticket per 2 tickets won)				

TICKET PATTERNS

PATTERN	NUMBER OF CUPS HIT			
	0-3	4-6	7-9	10
	TICKETS			
1	2	6	8	16 (+1 per remaining ball)
2	2	4	10	16 (+1 per remaining ball)
3	4	6	10	18 (+1 per remaining ball)
4	10	14	20	30 (+1 per remaining ball)
5	10	14	20	32 (+1 per remaining ball)
6	12	16	22	36 (+1 per remaining ball)

DIAGNOSTICS MENU

SINK IT Diagnostics Menu

<i>Cup 1 target</i>	<i>OFF</i>	<i>Blue Button</i>	<i>OFF</i>
<i>Cup 2 target</i>	<i>OFF</i>	<i>Red Button</i>	<i>OFF</i>
<i>Cup 3 target</i>	<i>OFF</i>	<i>Coin Input</i>	<i>OFF</i>
<i>Cup 4 target</i>	<i>OFF</i>	<i>DBA Input</i>	<i>OFF</i>
<i>Cup 5 target</i>	<i>OFF</i>	<i>Ball Trough</i>	<i>OFF</i>
<i>Cup 6 target</i>	<i>OFF</i>	<i>Ball Release</i>	<i>OFF</i>
<i>Cup 7 target</i>	<i>OFF</i>	<i>Low Ticket</i>	<i>OFF</i>
<i>Cup 8 target</i>	<i>OFF</i>		
<i>Cup 9 target</i>	<i>OFF</i>		
<i>Cup 10 target</i>	<i>OFF</i>		
<i>Cheat Detect</i>	<i>OFF</i>		

Dispense Ticket
Ball Motor
New background
Camera Calibrate
Exit Menu

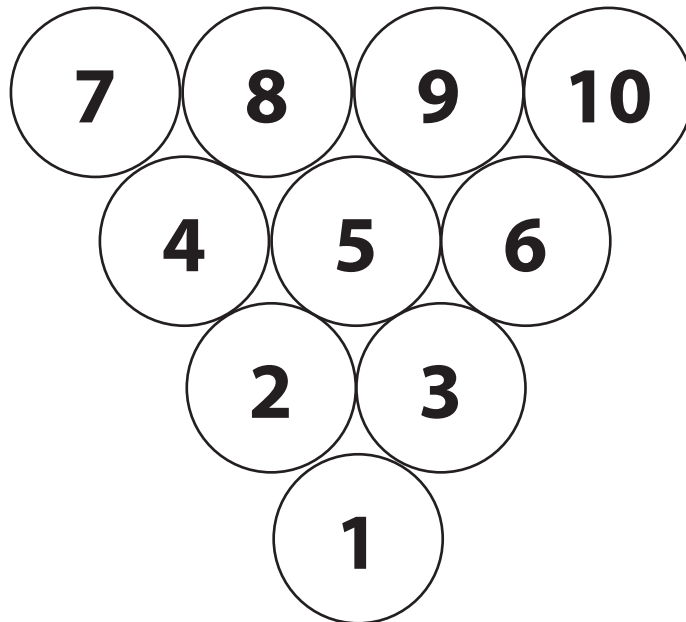
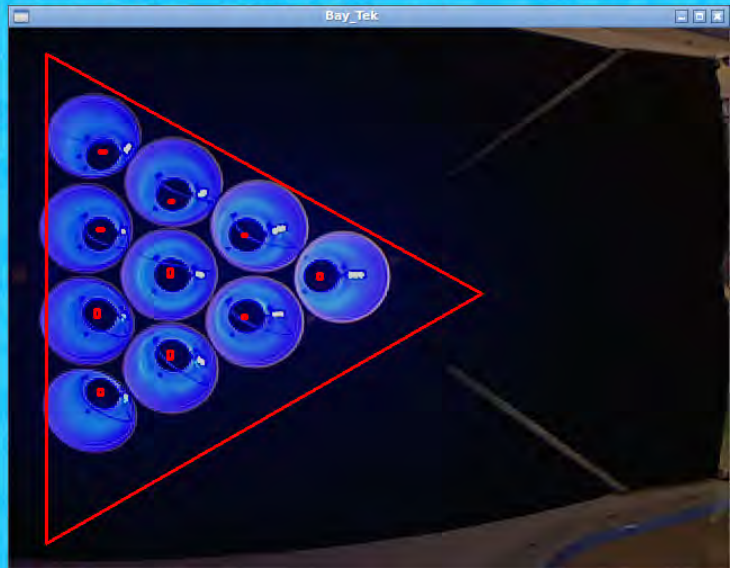

LOCATION NAME & ADVERTISING



Insert a USB stick containing your advertisements and text file into the USB port next to the menu buttons under the bounce platform.

LOCATION NAME:

Your location name can be entered manually with the on-screen keyboard and the player buttons, OR it can be uploaded from the USB stick (name.txt).

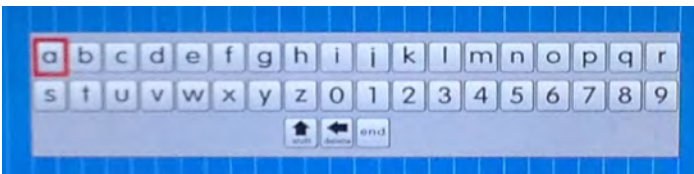

ADVERTISEMENTS:

The ideal size of an advertisement is 1280 x 960, in .png format. Ads must be named ad1.png, ad2.png, ad3.png and ad4.png to upload correctly.



You can add up to 4 different advertisements to the machine, which display in rotation during attract mode. The ads can be changed out at any time.

One USB stick can be used to program multiple machines to the same settings.

LOCAL CURRENCY SYMBOL:

Choose between \$, £ or none; this affects both price per play and earning reports.

MACHINE SETUP- HEAD TO HEAD

SINK IT Machine Setup	
Game Volume	5
Attract Volume	5
Attract Timing	1 min
Next Player Start Timeout	2 min
Timed Game Countdown Delay	15 sec
Cheat Detect Ends Game	3 warnings
Mech. Counter Advance	per Credit
Head 2 Head Machine ID	Off
H2H-Reg Game Select Delay	15 sec
H2H-Wait time 2nd Player	15 sec
H2H-Winner Extra Tickets	5
Demo Mode	Regular Play
Set Date/Time	
Exit Menu	

SETTINGS OPTIONS & FACTORY DEFAULTS													
Game Volume	0	1	2	3	4	5	6	7	8	9	10	11	12
Attract Volume	0	1	2	3	4	5	6	7	8	9	10	11	12
Attract Timing	off		30 sec		1 min		5 min		10 min		15 min		
Next Player Start Timeout	off	30 sec		1 min		2 min		3 min		5 min			
Timed Game Countdown Delay	off	5 sec		10 sec		15 sec		20 sec		25 sec		30 sec	
Cheat Detect End Game	off	never end for cheat detection						1 warning		2 warnings		3 warnings	
Head to Head Machine ID	off					left (Player 2)				right (Player 1)			
						Set according to game designation							
H2H- Reg Game Select Delay	5 sec		10 sec		15 sec		20 sec		25 sec		30 sec		
H2H- Wait time 2nd Player	5 sec		10 sec		15 sec		20 sec		25 sec		30 sec		
H2H- Winner Extra Tickets	0	1	2	3	4	5	6	7	8	9	10		

MACHINE SETUP- SINGLE GAME

SINK IT Machine Setup

Game Volume **5**
Attract Volume **5**
Attract Timing **1 min**
Next Player Start Timeout **2 min**
Timed Game Countdown Delay **15 sec**
Cheat Detect Ends Game **3 warnings**
Mech. Counter Advance **per Credit**

Head 2 Head Machine ID **Off**
H2H-Reg Game Select Delay **15 sec**
H2H-Wait time 2nd Player **15 sec**
H2H-Winner Extra Tickets **5**

Demo Mode **Regular Play**
Set Date/Time
Exit Menu

SETTINGS OPTIONS & FACTORY DEFAULTS													
Game Volume	0	1	2	3	4	5	6	7	8	9	10	11	12
Attract Volume	0	1	2	3	4	5	6	7	8	9	10	11	12
Attract Timing	off		30 sec		1 min		5 min		10 min		15 min		
Next Player Start Timeout	off	30 sec		1 min		2 min		3 min		5 min			
Timed Game Countdown Delay	off	5 sec		10 sec		15 sec		20 sec		25 sec		30 sec	
Cheat Detect End Game	off	never end for cheat detection						1 warning		2 warnings		3 warnings	
Head to Head Machine ID	off					left (Player 2)				right (Player 1)			
H2H- Reg Game Select Delay	5 sec		10 sec		15 sec		20 sec		25 sec		30 sec		
H2H- Wait time 2nd Player	5 sec		10 sec		15 sec		20 sec		25 sec		30 sec		
H2H- Winner Extra Tickets	0	1	2	3	4	5	6	7	8	9	10		

REPORTS MENU- HEAD TO HEAD

SINK IT Report Menu

Earnings Report
Tickets/Payout Report
Exit Menu

These reports will help you to determine the earnings, payout and overall number of plays generated by your Beer Pong game.

SINK IT Earnings Report
Bay Tek Games 12-20-2013

	Percent Total	Number of Credits	Income
Bill Acceptor	0%	0	\$ 0.00
Credit Card	0%	0	\$ 0.00
Coins	0%	0	\$ 0.00
<hr style="border-top: 1px dashed black;"/>			
Total		0	\$ 0.00

0 Total Games Played

**Clear All Earnings Stats Press 3x
Exit Menu**

SINK IT Ticket/Payout Rpt
Bay Tek Games 12-20-2013

Cups Made Bucket	Balls Remaining	Tickets	Num Games
0-3		10	0
4-6		14	0
7-9		20	0
10	0-9	32-41	0
10	10-19	42-51	0
10	20+	52	0
<hr style="border-top: 1px dashed black;"/>			
TOTAL Tickets/Games		0	0
H2H +Tickets-Games		0	0
AVG Tickets/Game		0	
PAYOUT Percentage		0%	

**Clear Ticket/Payout Stats Press 3x
Exit Menu**

REPORTS MENU- SINGLE GAME

SINK IT Report Menu

Earnings Report
Tickets/Payout Report
Exit Menu

These reports will help you to determine the earnings, payout and overall number of plays generated by your Beer Pong game.

SINK IT Earnings Report **Bay Tek Games 12-20-2013**

	Percent Total	Number of Credits	Income
Bill Acceptor	0%	0	\$ 0.00
Credit Card	0%	0	\$ 0.00
Coins	0%	0	\$ 0.00

Total		0	\$ 0.00
0 Total Games Played			

Clear All Earnings Stats Press 3x
Exit Menu

SINK IT Ticket/Payout Rpt **Bay Tek Games 12-20-2013**

Cups Made	Balls Remaining	Tickets	Num Games
0-3		10	0
4-6		14	0
7-9		20	0
10	0-9	32-41	0
10	10-19	42-51	0
10	20+	52	0

TOTAL Tickets/Games		0	0
AVG Tickets/Game		0	
PAYOUT Percentage		0%	

Clear Ticket/Payout Stats Press 3x
Exit Menu

SOFTWARE UPDATE

SINK IT Software Upgrade

Update saving all settings Press 3x

Update to new rev settings

Restore previous version

Restart updated game

Reset Factory Settings

Exit Menu

NEW SW UPDATE VERSIONS:

PC Software Version = None
Camera Software Version = None

CURRENT SW VERSIONS:

PC Software Version = 2.05.4
Camera Software Version = 1.23a

BACKED UP SW VERSIONS:

PC Software Version = None
Camera Software Version = None

MAINBOARD PINOUT GUIDE

BayTek BEER PONG NEWGEN1 Hardware REV G Pinout With AUX BOARD - Version 1.06

Pin Type	Purpose	Ref	Pin #
LOWSIDE #1, w diode		J22	1
LOWSIDE #2, w diode		J22	2
LOWSIDE #3		J22	3
LOWSIDE #4	NOT USED Trough Lights Red	J22	4
LOWSIDE #5	NOT USED Trough Lights Green	J22	5
LOWSIDE #6	NOT USED Trough Lights Blue	J22	6
LOWSIDE #7	NOT USED Bounce Area Lights	J22	7
LOWSIDE #8		J22	8
LOWSIDE #9	NOT USED Ball Un-Jammer Solenoid	J22	9
+12 Volts	OLD PROTO Mechanical Count #1 Game +12V	J22	11
+12 Volts	OLD PROTO Mechanical Count #2 Ticket +12V	J22	12
+12 Volts		J22	13
+12 Volts		J22	14
+12 Volts		J22	15
+12 Volts		J22	16

Low Side Driver
High Side Driver
TTL Input/Output
LED Constant Current Drive
= 12 Volts
= Ground

Pin Type	Purpose	Ref	Pin #
Ground		J24	1
Ground		J24	2
+12 Volts		J24	3
+12 Volts		J24	4
PB7	Ball Release Sensor	J24	5
LOWSIDE #12	Select Red Light	J24	6
PX29	Ball Trough Sensor	J24	7
HIGHSIDE #10	Scroll Blue Light	J24	8
HIGHSIDE #11	Ball Release Dispenser Motor	J24	9
3.3V		J24	10

PX37	Ticket Notch #1	J5	1
Ground	Ground for Ticket Dispenser	J5	2
PB18	Ticket Motor #1	J5	3
+12 Volts	Power for Ticket Dispenser	J5	4

PB16	Low Ticket Switch	J9	1
Ground	Ground for Low Ticket Switch	J9	2
PB17	Coin/DBA Lockout (Jersey)	J9	3
+12 Volts		J9	4

PA06	DBA Input	J8	1
+12 Volts		J8	2
Ground		J8	3
Ground		J8	4

HIGHSIDE #13	NEW Mechanical Count #1 Game	J25	1
HIGHSIDE #14	NEW Mechanical Count #2 Ticket	J25	2
PX10	Service Button #1	J25	3
PX11	Service Button #2	J25	4
Ground	Ground for Service Buttons	J25	5
Ground	Ground for Mechanical Count #1 & #2	J25	6

+12 Volts	Coin Door Power	J6	1
PA05	Coin Input	J6	2
Ground	Coin Ground	J6	3

MAINBOARD PINOUT GUIDE

1	J29	+12 Volts
2	J29	+12 Volts
3	J29	+12 Volts
4	J29	PA21
5	J29	PA23
6	J29	PA22
7	J29	PA25
8	J29	PA24
9	J29	PA27
10	J29	PA26
11	J29	PC0
12	J29	PA28
13	J29	PX20
14	J29	PC1
15	J29	PX21
16	J29	PB0
17	J29	PX22
18	J29	PB1
19	J29	PX24
20	J29	PX23
21	J29	PX26
22	J29	PX25
23	J29	PX28
24	J29	Ground
25	J29	Ground
26	J29	Ground

Cup 1 Lights
Cup 2 Lights
Cup 3 Lights
Cup 4 Lights
Cup 5 Lights
Cup 6 Lights
Cup 7 Lights
Cup 8 Lights
Cup 9 Lights
Cup 10 Lights

1	J21	PB19
2	J21	PX39
3	J21	PX00
4	J21	PX01
5	J21	PB20
6	J21	PX02
7	J21	PB21
8	J21	PB22
9	J21	PB23
10	J21	PB24
11	J21	Ground
12	J21	Ground
13	J21	Ground
14	J21	Ground
15	J21	+12 Volts
16	J21	+12 Volts
17	J21	+12 Volts
18	J21	+12 Volts
19	J21	PB25
20	J21	PB26

Credit Card Reader Input

Select Switch
Game Start Switch

MINIGEN PINOUT (AANEWGEN1-PJ/RBN)

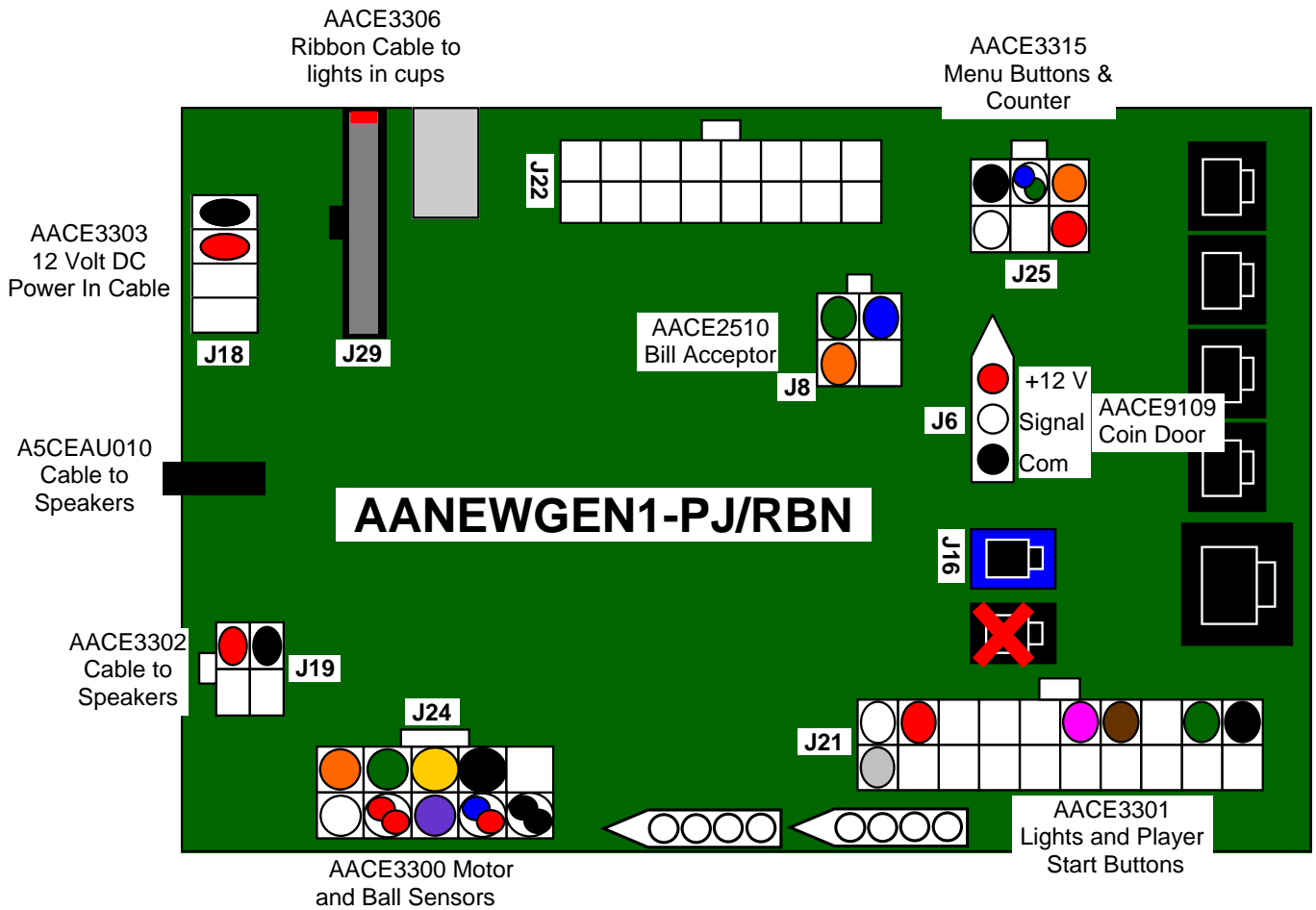

WIRING DIAGRAMS

COIN MECH, MENU BUTTON & COUNTERS

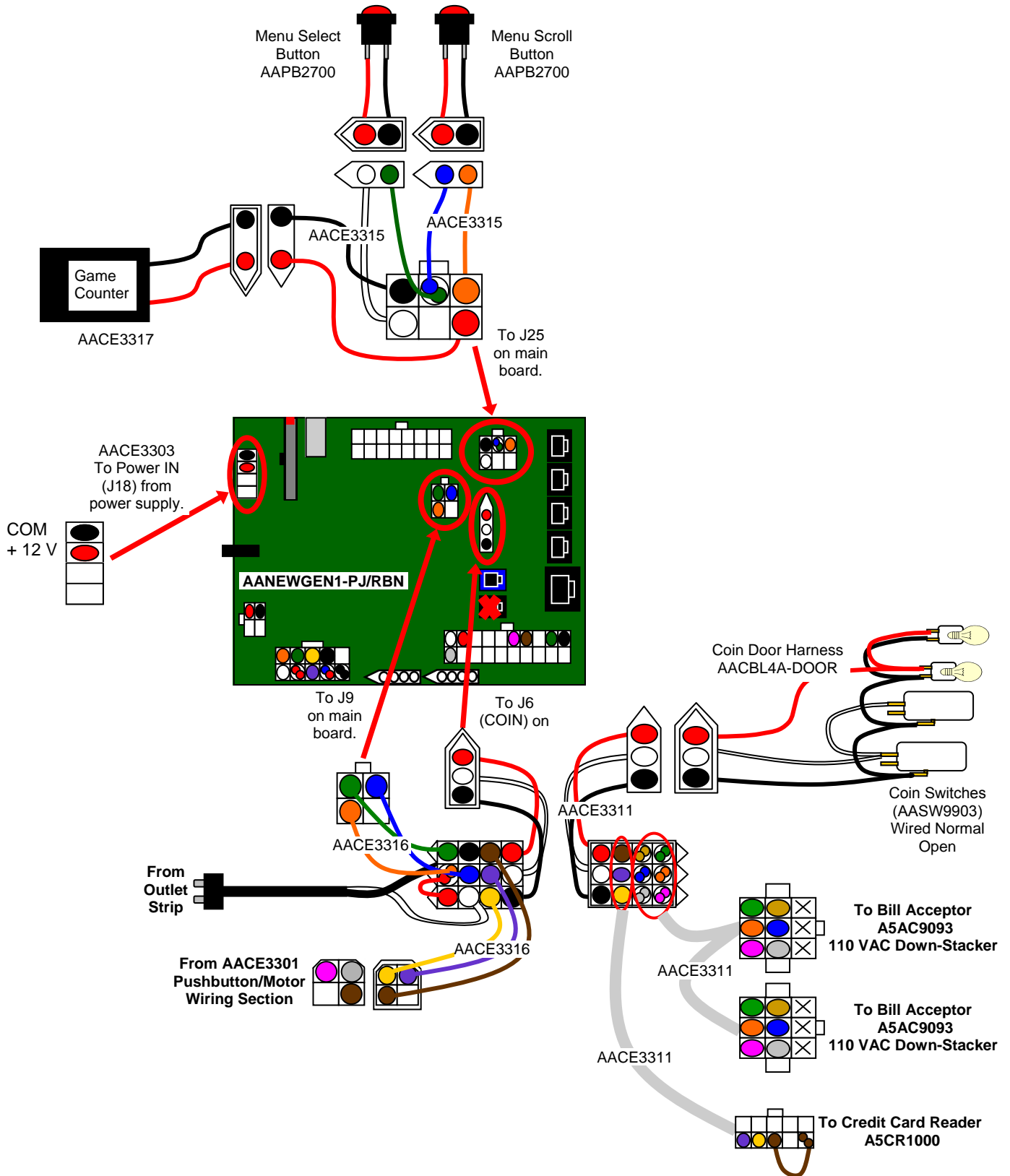

WIRING DIAGRAMS

PLAYER BUTTON, MOTOR & SENSORS

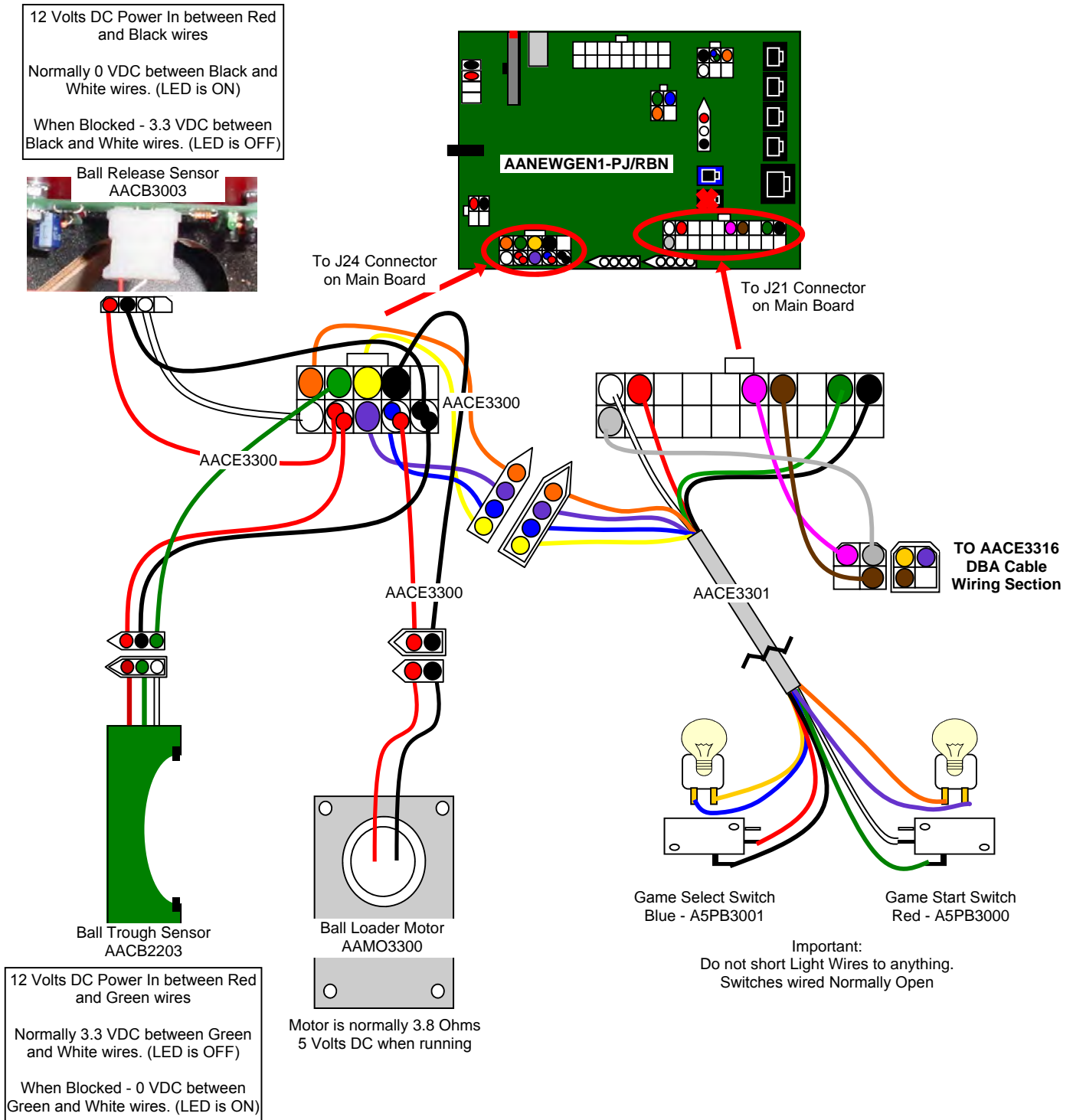

WIRING DIAGRAMS

MOTHERBOARD COMMUNICATION

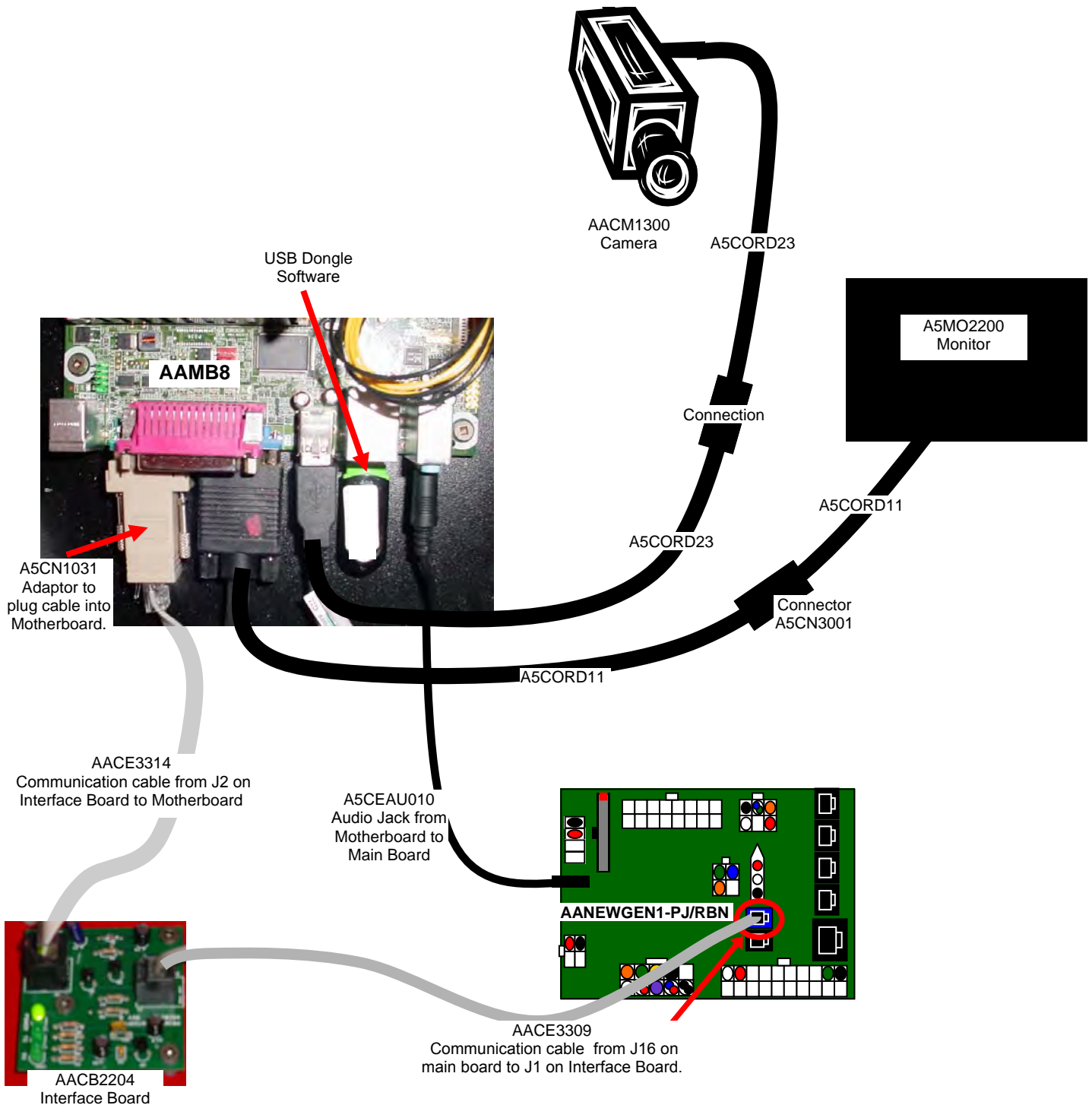

WIRING DIAGRAMS

CUP LIGHTS & SPEAKER

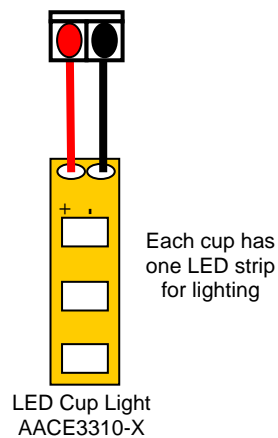
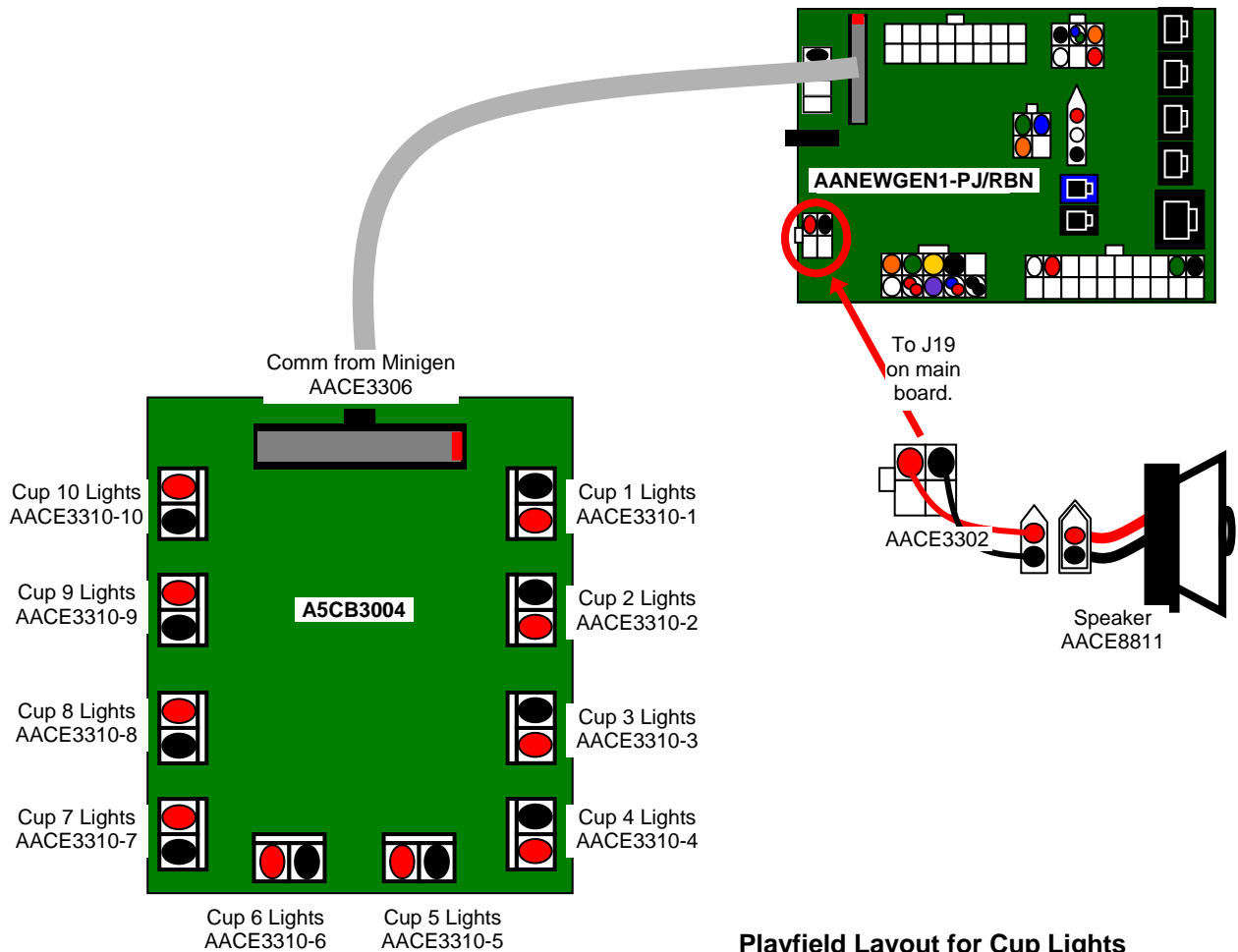

Playfield Layout for Cup Lights

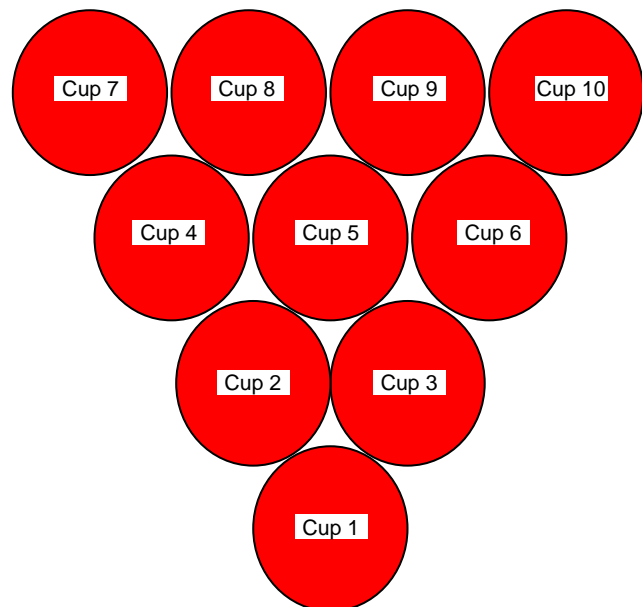

WIRING DIAGRAMS

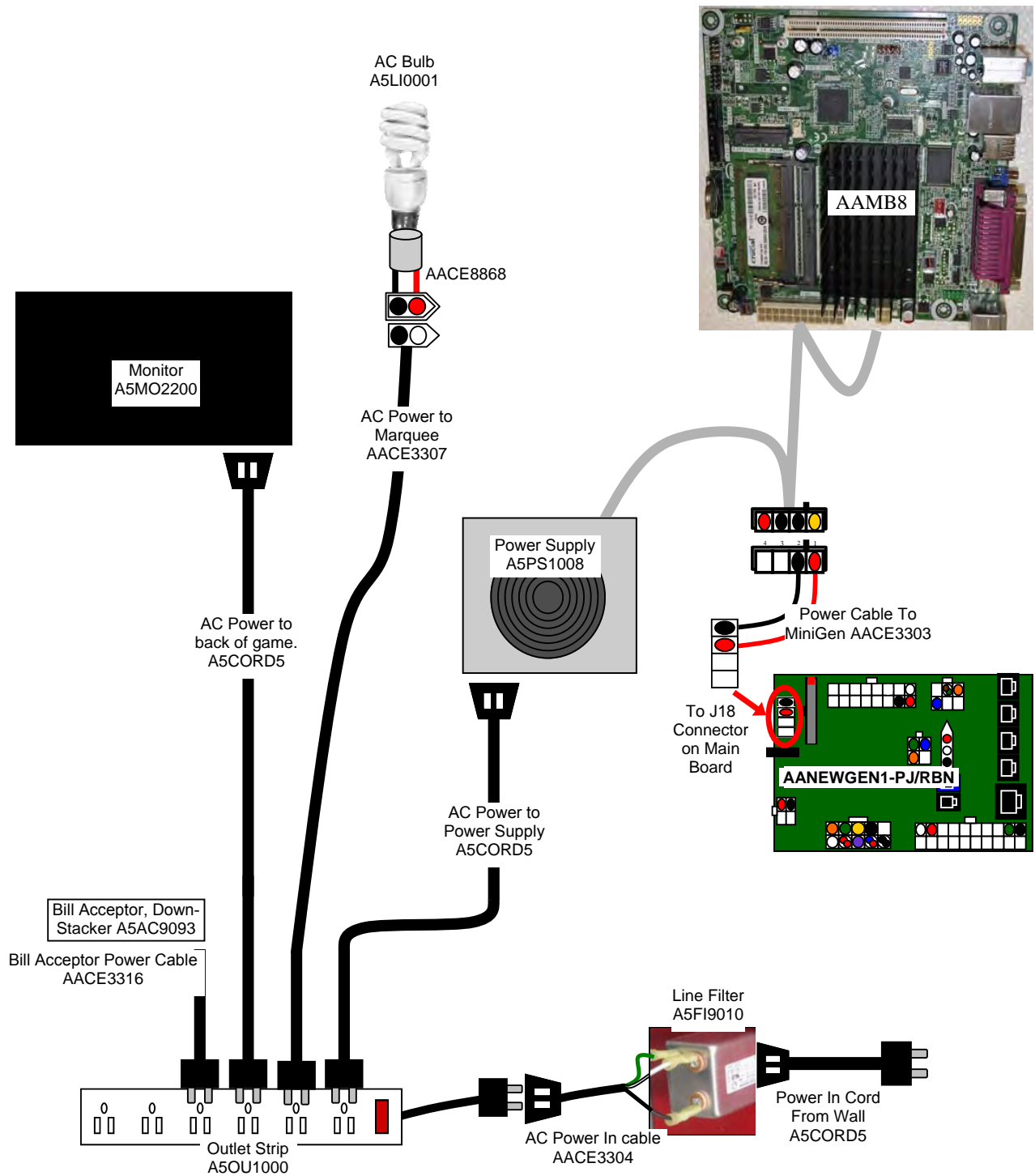

A/C IN & POWER SUPPLY



TROUBLESHOOTING GUIDE

Troubleshooting Strategy

Use common sense and a systematic method of troubleshooting to determine the exact problem, probable cause and remedy. Use the process of elimination to find the faulty component. Always check for the simple and obvious causes first such as unplugged, loose or broken wires and bad sensors, bent, pinched, stuck or jammed components.

Troubleshooting Chart		
Problem	Probable Cause	Remedy
<p>No power to the game. No lights on at all.</p>	<p>Unplugged. Circuit breaker tripped. Line Filter Faulty. Power strip faulty. Faulty cable/power supply.</p>	<p>Check wall outlet. Reset power strip breaker switch or building circuit breaker. Replace Line Filter (Part # A5FI9010) Change plug position, replace if needed. See Power Supply diagnostic below.</p>
<p>AC Light and Bill Acceptor on. But everything else off. (Power Supply not ON)</p>	<p>Power supply unplugged. Rocker Switch. Power supply shutting down because of 12 V overload. Faulty power supply.</p>	<p>Insure unit is plugged into power strip. Make sure rocker switch is set ON.  See power supply diagnostics to isolate bad component. A bad motor or 12 volt short would cause this. See Power Supply Diagnostic below.</p>
<p>Dollar Bill Acceptor not functioning.</p> <p>Ensure Bill Acceptor is set to "Always Enable"</p> <p>Important : Only 110 Volt AC DBA is to be installed.</p> <p>Enter Diagnostic Menu to see if DBA input goes to ON quickly when bill is inserted.</p> 	<p>Look for "Check Minigen Comm" error on screen. Check for power to Bill Acceptor. Dirt or debris in acceptor slot. Pinched, broken, or disconnected wiring. Bill acceptor problem.</p>	<p>Refer to "Check Minigen Comm" error diagnostic section. Acceptor should cycle stacker at game power up. If not, check cable connections. Refer to "How to Clean Bill Acceptor" Or clean with bill reader cleaning card. (A5CC9000) Check wiring from bill acceptor to Mini Gen Board. (AACE3316, AACE3311) Repair or replace wiring harness. Check J9 connector on Main Board Make sure wires are secure in connectors. Refer to troubleshooting section of dollar bill acceptor manual included with this game or the diagnostics label of the back of the unit.</p>
<p>No Sound</p>	<p>Volume set to zero in menu. Disconnected, loose or broken wires. Faulty speaker.</p>	<p>Enter Machine Setup Menu and verify: Game Volume & Attract Volume is not zero Check connections and reseat J19 on main board. Cable # AACE3302 Replace speaker. AACE8811</p>

TROUBLESHOOTING GUIDE

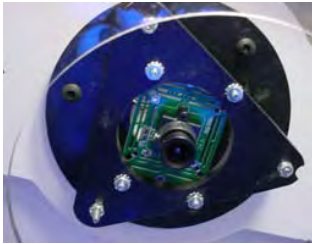
Problem	Probable Cause	Remedy
<p>Scoring Incorrectly</p> 	<p>All scoring is registered with a camera in top of cabinet.</p> <p>It is OK if camera is mounted on angle.</p> <p>Enter Diagnostic Menu to see "live" view of camera</p>	<p>If no camera picture in Diagnostic Menu: Check:</p> <ul style="list-style-type: none"> Camera (Part # AACM1300) Cable (Part # A5CORD23) USB connection at motherboard Replace motherboard. (Part # AAMB8/)

How to Calibrate Camera

- 1.) Enter Diagnostic Menu to see "live" view of camera.
 - Verify all cups are within triangle pattern shown on monitor.
 - Verify squares are aligned with the holes in bottom of cups.
 - All cup targets should read "OFF" when camera is aligned.

If problem here - scroll down and select "Camera Calibration". This will reset the image.

If problem still exists:

- Ensure camera is secure in game.
- Ensure cup assembly is positioned correctly.



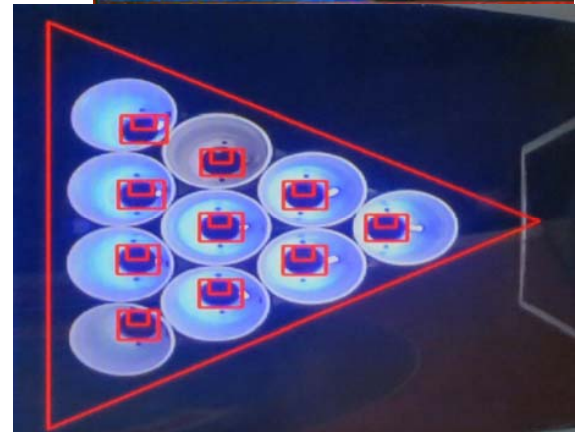

The camera is installed in it's housing to ensure correct distance and alignment with the cup assembly.
Check connections from camera to motherboard.

- 2.) Toss balls into each cup and verify that the corresponding "Cup target" flashes to ON in the diagnostic screen.





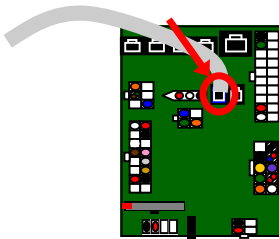
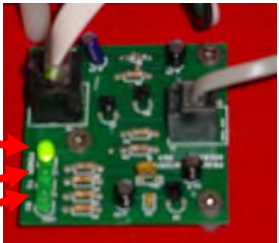

Cup Lights not working	All Cup light stay ON or stay OFF.	Make sure balls are scoring. Playfield Aux Board faulty. (A5CB3004) Cable to Minigen faulty. (AACE3306) Faulty Minigen board. (AANEWGEN1-PJ/RBN)
	Individual cup lights not working	Faulty LED light strip inside cup. (AACE3310-X) Playfield Aux Board faulty. (A5CB3004)



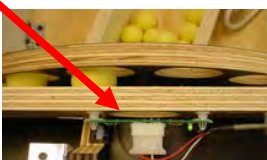



TROUBLESHOOTING GUIDE

Problem	Probable Cause	Remedy
<p>Game not coining up.</p> <p>Note: If game is equipped with 2 Bill Acceptors, they both share the signal line to Mini Gen Board to Connector J9</p> <p>Enter Diagnostic Menu to see if Coin input goes to ON quickly when coin is inserted.</p> 	<p>Look for “Check Minigen Comm” error on screen.</p> <p>Ensure game makes sound when coin switch is triggered.</p> <p>Game set to large amount of credits per game.</p>	<p>Refer to “Check Minigen Comm” error diagnostic section.</p> <p>Check coin switches—both should be wired normally open. If one switch is “closed” the other will not work either.</p> <p>Check wiring to Mini Gen Board. (AACBL4A-DOOR, AACE3316, AACE3311)</p> <p>Check Game Setup Menu. Ensure Coins/ Credits per Game is set. Default = 4.</p>
<p>Meter does not work.</p> <p>Credit meter will click as each coin is inserted.</p>	<p>Disconnected, loose or broken wires.</p> <p>Faulty counter.</p>	<p>Check connections and reseal J25 on Minigen board. Cables # AACE3315and AACE3317</p> <p>Replace counter. AACE3317</p>
 <p>Check Minigen Comm Error</p> <p>Game does not coin up but credit meter clicks.</p>	<p>Main Board and wiring to coin switch OK.</p> <p>Check green LED’s on Serial Interface board. Is “Power” solid ON? Is “TX” & “RX” blinking very fast?</p> <p>If “Power” is not solid ON</p> <p>Ensure AACE3309 cable is plugged into blue “IN” socket on main board. (J16) Replace if needed.</p> <p>Replace Serial Interface board. (AACB2204)</p> 	 <p>If “TX” & “RX” are not blinking very fast Communication to Motherboard faulty.</p> <p>Check AACE3314 to motherboard. Check or replace adaptor (A5CN1031)</p> 

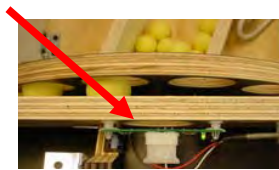

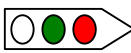

TROUBLESHOOTING GUIDE

Problem	Probable Cause	Remedy
Balls not releasing	- There are many factors that could contribute to the balls not releasing. Please browse through the following sections: <ul style="list-style-type: none"> - Not enough balls in game - Ball jam - Error on screen - Faulty Motor - Ball release sensor blocked/bad - Ball trough sensor blocked/bad 	
Not enough balls in game	Add balls (Part # A5BA4050) Any ping pong balls will work.	Game should have 25 balls in it. Too many is bad - they may block a sensor
Ball jam	Too many balls in game.	Game should have only 25 balls in it. If balls stack up and block sensor boards, it will not release balls.
	Ball release sensor causing motor to pause. 	If ball release sensor is blocked, it will stop motor until the blockage is cleared. Ball Jam message will appear on screen: 
	Physical blockage in game.	Inspect ball path and ensure no debris is blocking balls.
Error on screen 	If game detects a ball blocking the ball release sensor, it will power off motor to avoid damage to motor.	Remove jam from sensor. Refer to "Ball Release Sensor Blocked/Bad" section.
Faulty Motor 	Check for blocked Ball Release sensor.	Unplug Ball Release sensor to see if motor starts working again.
	Disconnected, loose or broken wires.	Check connections from motor to Minigen board. (Cable # AACE3300, AAMO3300)
	Faulty motor.	Check for 3.8 Ohms across motor leads. Check for 5 Volts DC when running. Replace motor. (Part # AAMO3300)
	Enter Diagnostic Menu to test motor.	Select "Turn on Motor" to force motor ON.
	Faulty Minigen Board	If 0 volts when motor should be running, Minigen board may be bad. (Part # AANEWGEN1-PJ/RBN)



TROUBLESHOOTING GUIDE

Problem	Probable Cause	Remedy
<p>Balls not releasing - There are many factors that could contribute to the balls not releasing. Please browse through the following sections:</p> <ul style="list-style-type: none"> - Not enough balls in game - Ball jam - Error on screen - Faulty Motor - Ball release sensor blocked/bad - Ball trough sensor blocked/bad 		
<p>Ball release sensor blocked/bad</p>  	<p>Too many balls in game blocking sensor, software will stop motor to prevent damage "Ball Jam—See Attendant" will show on screen</p> <p>Check voltage with DC Multi-meter</p>  <p>Disconnected, loose or broken wires.</p> <p>Enter Diagnostic Menu to see if game recognizes sensor.</p> <p>Faulty sensor.</p>	<p>Game should have only 25 balls, if there are too many balls, they will back up and block sensor, turning off motor.</p> <p>Check power: 12 Volts DC Power In between Red and Black wire Normally 0 VDC between Black and White wires. (LED is ON) When Blocked - 3.3 VDC between Black and White wires. (LED is OFF)</p> <p>Check connections from sensor to Minigen board. Cable # (AACE3300)</p> <p>Ball Release should go to ON when sensor is blocked.</p>  <p>Replace sensor. (Part # AACB3003)</p>
<p>Ball trough sensor blocked/bad</p> 	<p>If ball trough sensor does not see balls played, game will not release more balls.</p> <p>Check voltage with DC Multi-meter</p>  <p>Disconnected, loose or broken wires.</p> <p>Enter Diagnostic Menu to see if game recognizes sensor.</p> <p>Faulty sensor.</p>	<p>Ensure ball trough is clear and not blocked with debris.</p> <p>Check power: 12 Volts DC Power In between Red and Green wire. Normally 3.3 VDC between Green and White wires. (LED is OFF) When Blocked - 0 VDC between Green and White wires. (LED is ON)</p> <p>Check connections from sensor to Minigen board. Cable # (AACE3300)</p> <p>Ball Trough should go to ON when sensor is blocked.</p>  <p>Replace sensor. (Part # AACB2203)</p>

TROUBLESHOOTING GUIDE

Problem	Probable Cause	Remedy
<p>Not counting balls</p> 	<p>Any balls missing the cups will be counted by the Ball Trough Sensor</p> <p>Check voltage with DC Multi-meter</p> <p>Disconnected, loose or broken wires.</p> <p>Enter Diagnostic Menu to see if game recognizes sensor.</p> <p>Faulty sensor.</p>	<p>Ensure ball trough is clear and not blocked with debris.</p> <p>Check power: 12 Volts DC Power In between Red and Green wire.</p> <p>Normally 3.3 VDC between Green and White wires. (LED is OFF)</p> <p>When Blocked - 0 VDC between Green and White wires. (LED is ON)</p> <p>Check connections from sensor to Minigen board. Cable # (AACE3300)</p> <p>Ball Trough should go to ON when sensor is blocked.</p>  <p>Replace sensor. (Part # AACB2203)</p>
<p>Counting too many balls</p>	<p>Ball Trough Sensor is "seeing" too many balls pass through.</p>	<p>Test with finger to ensure LED goes ON.</p> <p>If LED is dim all the time, sensor is bad.</p> <p>Replace sensor. (Part # AACB2203)</p>
<p>Buttons do not work.</p> 	<p>Button stuck, sticky or broken.</p> <p>Disconnected, loose or broken wires.</p> <p>Enter Diagnostic Menu to see if game recognizes button.</p> <p>Faulty button.</p>	<p>Clean top of button, ensure it springs back when pushed down. Look for broken tab on bottom of switch.</p> <p>Check connections from switch to Minigen board. (Cable # AACE3301)</p> <p>Button should go to ON when button is pushed.</p>  <p>Replace button. A5PB3000 for Red. A5PB3001 for Blue.</p>
<p>Button lights do not work.</p> 	<p>Light bulb itself burned out.</p> <p>Disconnected, loose or broken wires.</p> <p>Faulty button.</p>	<p>Check for 12 Volts DC across lights: Purple and Orange for Red Light Blue and Yellow for Blue Light</p> <p>Check connections from switch to Minigen board. (Cable # AACE3301)</p> <p>Replace button. A5PB3000 for Red. A5PB3001 for Blue.</p>

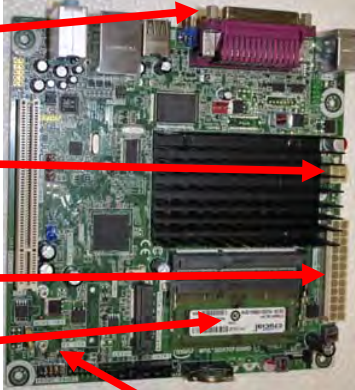
TROUBLESHOOTING GUIDE

Problem	Probable Cause	Remedy
<p>Monitor not working.</p> <p>Power down, wait 10 seconds and power up again.</p>	<p>Monitor says "NO SIGNAL" for 5 seconds after power-up. Then dark.</p> <p>Monitor VGA cable unplugged.</p> <p>Small 12 Volt power connector unplugged on motherboard.</p> <p>Large power connector unplugged on motherboard</p> <p>Faulty or loose RAM</p> <p>Faulty power supply - Check for 12 Volts and green LED on motherboard.</p> <p>Faulty motherboard - Replace faulty board. (AAMB8)</p>	
<p>Monitor has nothing at all on power up.</p>	<p>Power cable unplugged from monitor.</p> <p>Faulty monitor.</p>	<p>Ensure power is plugged into back of monitor, down to power strip.</p> <p>Replace monitor. (A5MO2200)</p>
<p>Error on screen at power up.</p> <p>Re-Boot game to see if problem still exists.</p>	<p>Display stops at "No bootable device -- insert boot disk and press any key"</p> <p>Display shows "Puppy Video Wizard" or "Xorg"</p> <p>Display shows "Kernel panic – unable to mount root"</p>	<p>USB Flash Drive unplugged from board or faulty. Re-seat and try power on to game again.</p> <p>Game is not recognizing monitor. Ensure VGA cable is secure to I/O board. Replace monitor. (A5MO2200)</p> <p>Faulty or loose RAM</p>
<p>Monitor problems</p> <p>Blurry Monitor Too bright, or dim.</p> 	<p>Open back door of cabinet. Monitor will swing out on door. Menu buttons are located on bottom right edge of monitor, partially hidden by clear plexi of monitor.</p> <p>Press the far left button (Auto) to select Auto Adjustment. This may take a few seconds.</p> <p>Verify that the screen looks good and image is centered.</p>	

POWER SUPPLY DIAGNOSTICS

1.) Verify AC power to game. Check power strip in front door.

The rocker switch should be illuminated.



3.) Check connection to power supply.

4.) Ensure Power Supply switch is set to 115V (or 230V)
(Some model power supplies may not have this)

5.) Ensure Power switch is on.

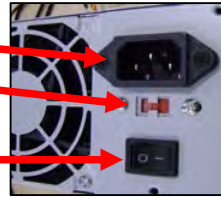

6.) Ensure fan is turning.

- If power supply fan is turning and there is no 12 Volt out, then replace power supply. (A5PS1008)
- If power supply fan is not turning, then continue to "Verify Power to Motherboard"

Verify Power to Motherboard

The motherboard will turn on power supply.

If your game has no 12 volts, it may be the motherboard not turning on.

In addition - there may be a 12 volt short somewhere else in cabinet that is not allowing the power supply to turn on.

Minimize load on power supply and isolate short

Unplug all outputs from power supply except for motherboard.

This will have power supply, motherboard, and monitor left plugged in.

If power supply, motherboard, and monitor now turn on:

Plug in one component at a time to power supply to locate short.

If power supply still does not power on, then continue to steps 1,2, and 3.

1 - Green LED on motherboard should be ON.

2 - Check BOTH connections from power supply.

If this is not on, recheck power supply or replace motherboard. (AAMB8)

Large power supply connection.

Black and yellow wires (12 Volts DC)

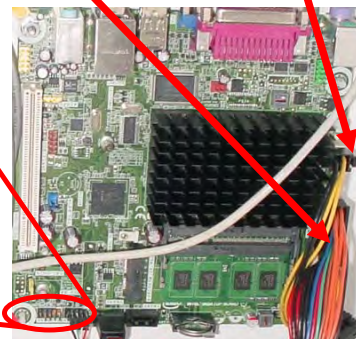

3 - Motherboard "Jump Start"
If green Led is ON, but game not on, you may start motherboard by quickly touching these 2 red pins at the same time.
Motherboard may turn ON and boot normally.

Note: The location of these connectors may vary depending on which version motherboard is in

If power supply still does not power on, replace power supply. (A5PS1008), replace motherboard. (AAMB7)

BILL ACCEPTOR DIAGNOSTICS

Note: There are many different models and brands of Bill Acceptors that are used on redemption games. Your Bill Acceptor may differ from the unit shown.

Determine if Bill Acceptor has power:
Turn game ON—The bill acceptor should make noise as stacker cycles and green lights on outside bezel should flash.

If NO power:
Use meter to measure 110 AC voltage at cable going into Bill Acceptor from power strip.

If power is OK:
Clean Bill Acceptor path to make sure there is nothing jamming unit.
Check dipswitch settings on side of acceptor.

Make sure switch # 8 is OFF for Always Enable

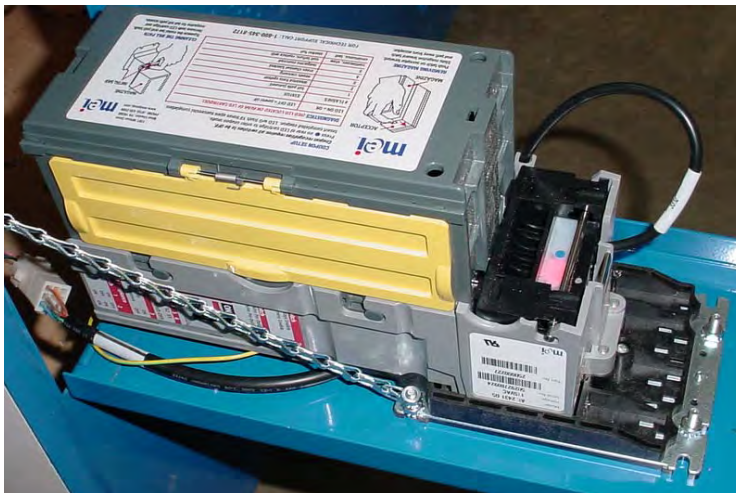

ERROR CODES

Count the number of flashes on front bezel of Bill Acceptor and follow chart for repair.

REMOVING MAGAZINE
Push latch on acceptor forward. Slide magazine toward latch and pull away from acceptor.

COUPON SETUP
Coupon recognition requires all switches to be OFF. Press ● on rear of LED cartridge to enter coupon mode. Insert completed coupon. LED will flash 10 times upon successful completion.

DIAGNOSTICS (RED LED LOCATED ON REAR OF LED CARTRIDGE)

# FLASHES	STATUS
1	bill path jammed
2	disabled from system
3	needs cleaning
4	cross channel blocked
5	magazine removed
continuous, slow	unit failure; replace unit
continuous, fast	stacker full

CLEANING THE BILL PATH
Squeeze the metal bar and pull up. Remove both LED cartridge and magazine for full bill path cleaning.

FOR TECHNICAL SUPPORT CALL: 1-800-345-8172

HOW TO: ACCESS MAINBOARD/ MOTOR

Unlock 2 top locks and flip open front panel.



Slide "Bounce Pad" out toward front of game.

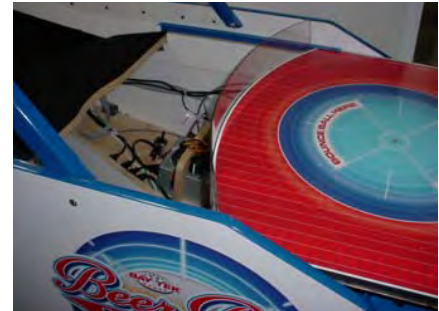

Motherboard, Power Supply, Minigen board and Communication board are now accessible.



To Remove Motor:

Remove 4 screws from center of wood wheel.

Motor can now be unscrewed and removed from game.



HOW TO: REMOVE BALL SENSOR

Unlock 2 top locks and flip open front panel.



Slide "Bounce Pad" out toward front of game.



Remove 2 screws from brackets on both sides of the cabinet and remove carpeted wood platform.



Remove screws from brackets holding vertical wood that sensor is mounted to.

Lift wood out of cabinet, unplug sensor, and remove sensor.



HOW TO: REMOVE CUP ASSEMBLY



Remove 2 screws holding cup platform in place.

HOW TO: ACCESS CAMERA/ AC LIGHT

Remove 3 screws holding wood support in place.

Slide plexi toward front of cabinet and remove from game.



CREDIT CARD READER

Beer Pong Masters is credit card reader ready. Baytek sells a credit card reader that will connect to a harness inside cabinet and will communicate via cell phone signals. No need for an internet connection.



The E-Port Reader will involve drilling holes in the left side of your metal front to mount. Instructions will come with E-Port Reader, here is a picture of it mounted on metal plate.

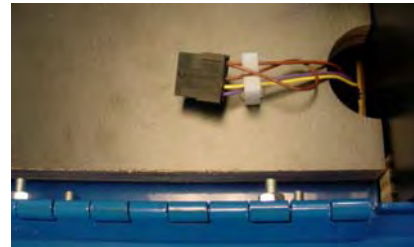

The E-Port Reader will plug into cable positioned in cabinet.

Enter "Game Setup" Menu to select number of games per credit card swipe.

Normally this is set to 4 games per swipe.
(\$4.00 per swipe at \$1.00 per play)



**Any questions on E-Port credit card readers -
Please call E-Port technical support at (888) 561-4748**

PARTS LIST

PART #	DESCRIPTION	PART #	DESCRIPTION
A5PL9097	Plate, replaces the bill acceptor	AACE3300	Cable, Count Sensor
A5BA4050	Ball, Ping Pong Ball	AACE3301	Cable, Main Door
A5VF2002	Con Box, Black Plastic	AACE3302	Cable, Volume
A5CE6601	Cable, USB, 6 foot	AACE3303	Cable, Minigen Power In Cable
A5CEAU010	Cable, Audio Stereo	AACE3304	Cable, Main Power Cable
A5CN1031	Adapter for Motherboard	AACE3306	Cable, Ribbon from Minigen to AUX Board
A5CO4203	Cover for Speaker	AACE3307	Cable, Fluorescent Light
A5CORD14	Cord, USB 3 foot, Right angle connector		
A5CN3001	Connector VGA-VGA Adaptor	AACE3309	Cable, Minigen to Interface Comm
A5CORD23	Cord, USB 10 foot	AACE3310-1	Cable, Playfield Cup #1 Light
A5CORD5	AC Power Cord	AACE3310-2	Cable, Playfield Cup #2 Light
A5CU3000	Cup, Solo, Red 16 OZ	AACE3310-3	Cable, Playfield Cup #3 Light
A5DE3000	Decal, Marquee	AACE3310-4	Cable, Playfield Cup #4 Light
A5DE3001	Decal, Throw Line Floor	AACE3310-5	Cable, Playfield Cup #5 Light
A5DE3002	Decal, Bounce Pad	AACE3310-6	Cable, Playfield Cup #6 Light
A5DE3003	Decal, Side Cabinet	AACE3310-7	Cable, Playfield Cup #7 Light
A5DE3004	Decal, Front Cabinet	AACE3310-8	Cable, Playfield Cup #8 Light
A5DE3007	Decal, Seam Decal Right	AACE3310-9	Cable, Playfield Cup #9 Light
A5DE3008	Decal, Seam Decal Left	AACE3310-10	Cable, Playfield Cup #10 Light
A5DE3009	Decal, Back Wall around Monitor	AACE3311	Cable, Dual DBA Cable
A5DE3010-1	Decal, Control Panel, Left Side	AACE3314	Cable, Interface to Motherboard Comm
A5DE3010-2	Decal, Control Panel, Right Side	AACE3315	Cable, Menu Buttons
A5F19010	Decal, Bottom Front, around cash box	AACE3316	Cable, DBA Cable
A5HU1200	Hub on Ball Loader Motor	AACE8868	Cable, Fluorescent Light Socket
A5LI0001	AC Light Compact Fluorescent	AACBL4A-DOOR	Cable, Coin Mech
A5LK2000	Lock for Coin Box	AACE3317	Credit Counter
A5LK5001	Lock for Front and Back Door	AAMO3300	Motor, Ball Loader
A5MO2200	Monitor, 22 Inch	A5AC9093	Dollar Bill Acceptor, Down Stacker, 110AC
A5ME3000	Metal Support Marquee	A5CB3004	AUX Board for Lights in Cups
A5ME3001	Metal Motor Plate	AACB2204	Interface Board
A5ME3002	Metal Left Window Rail	AACB2203	Ball Trough Sensor
A5ME3003	Metal Right Window Rail	AACB3003	Ball Release Sensor
A5ME3004	Metal Downstacker BBA Plate	AACE8811	Speaker Assy.
A5OU1000	Outlet Strip AC	AAMB7	Motherboard
A5PB3000	Pushbutton, Start, Red	AANEWGEN1-PJ/RBN	Minigen Board
A5PB3001	Pushbutton, Select, Blue	AACM3000	Camera for Beer Pong
AAPB2700	Pushbutton, Menu buttons	A5PS1008	Power Supply Ultra LS350W

PARTS PICTURES

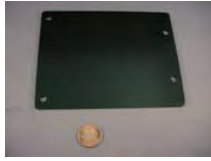

A5PL9097

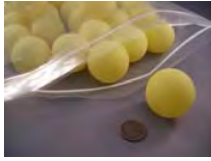

A5BA4050



A5VF2002



A5CE6601



A5CEAU010

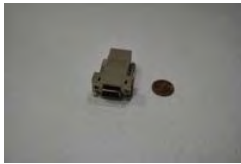

A5CN1031

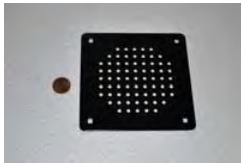

A5CO4203



A5CORD14



A5CORD23

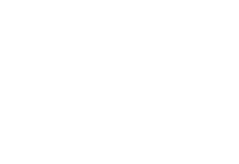

A5CN3001



A5CORD5



A5CU3000



A5FI9010



A5HU1200



A5OU1000



A5LK2000



A5LK5001



A5PB3000



A5PB3001

PARTS PICTURES



AACBL4A-DOOR



A5LI0001



AACE8811



AAPB2700



AACE3300



AACE3301



AACE3302



AACE3303



AACE3304



AACE3306



AACE3307



AACE3309



AACE3310-X



AACE3311



AACE3314



AACE9109



AACE3317



AAMO3300

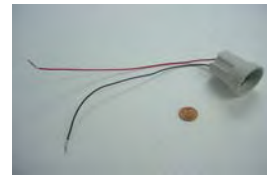

AACE8868



A5PS1008



A5AC9093

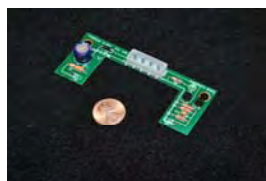

AACB3003



AACB2204



AACB2203



AACB3003



AAMB7



AANEWGEN1-PJ/RBN



AACM3000

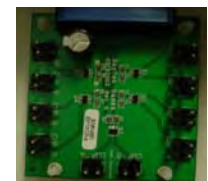

AACB3004

TECHNICAL SUPPORT

Excellent customer service is very important to Bay Tek Games!

We know that keeping your games in great operating condition is important to your business. When you need us, we are here to help. You can call us for free technical assistance, and you can count on us to have parts on-hand to support your game. We offer options that fit your needs.

Electronics / Circuit Boards - Repair Options

Repair & Return – If you have Circuit Board issues with your Bay Tek game, you can send the board to us and we'll repair it right away. Most items sent to us are repaired and returned to you within two days. This option is your best value as we offer this fast turn-around service at the most reasonable price.

Advance Replacement – If you have Circuit Board issues with your Bay Tek game, but you don't have time to send in your board in for repair, give us a call and ask for an Advance Replacement. We'll send you a replacement board that same day (pending availability). When you get your new board, just repackage the defective board in the same box and send it back to us. We make it easy by including a UPS Return Shipping label for you to put on the box (not available for international shipments). This is your best option when you need to get your game up and running as quickly as possible!

Spare Parts – Take matters into your own hands and purchase new spare Circuit Boards for your Bay Tek games. Many of our games share the same main-board electronics. This means you can buy one set of spare electronics to support many of your Bay Tek games. Spare boards allow you to get your game up and running the quickest and provide you a valuable troubleshooting option. Call our technicians to get recommendations for what you should keep on hand for spare parts!

Technical Support:

“You” are the best tool for troubleshooting! Your abilities to understand the game and your skills to repair the game are invaluable to us! If you need help, you know you can call us. It's not easy to diagnose a game remotely by phone, but our technicians do a great job. They'll need your help to perform some troubleshooting steps and convey to them exactly what's happening with your game.

Returns, Credits, & Fees:

NOTICE! ALL ITEMS being sent to Bay Tek Games for repair or return, etc. require prior Return Authorization! Bay Tek Games will provide a Product Return Form with an authorizing Ticket Number for each item to be returned. Please be certain to include this document with all shipments!

Late Fees and Non-Return Fees - Advance Replacement and Warranty Replacement items require the defective items to be returned by Bay Tek games promptly to avoid Late Fees. We expect items to be returned with 10 working days. Late fees are invoiced monthly. Late fees are non-refundable under any circumstance! Any item not returned within 90 days will be invoiced in full as a replacement part.

Bench Fees - Bench fees will apply for each electronic item returned to Bay Tek Games (this includes unused Advance Replacement items). This charge covers our cost to inspect, evaluate and retest each item. Please note that returned items that do not pass our tests will be charged accordingly as replacement items or advance replacements.

Restocking Fees - Unused items returned for credit will be credited minus a restocking fee. Items must be returned within 30 days of purchase in order to qualify for any credit amount. No shipping charges will be credited.

WARRANTY

Bay Tek Games warrants to the original purchaser that all component parts will be free of defects in workmanship and materials for a period of 6 months from the date of purchase. An additional 3 month warranty extension can be obtained by filling out and submitting the Warranty Registration for each machine. Warranty Registration cards may be found as shipped with each machine or online at our website. These must be filled out and submitted to Bay Tek Games within 30 days of purchase to be valid.

For any game/machine we manufacture that is within its warranty period, with notification to our Parts & Service Department, Bay Tek Games will, without charge, repair or replace defective component parts. It is the owner's responsibility to diagnose, remove and replace any faulty component part at their own expense & peril. As needed, at no charge, Bay Tek Games can provide reasonable telephone technical support during our normal business hours.

All claims of defective parts are subject to review upon our inspection of the faulty item. This warranty does not apply in the event of any misuse or abuse to the product, or as a result of any unauthorized repairs or alterations. The warranty does not apply if any serial number decal is altered, replaced or removed from its original position.

To process warranty replacement claims, customers may be charged for the replacement item at the time of shipment and later credited the same amount when the faulty item is returned and has passed our inspection. Bay Tek Games will provide the customer a pre-paid return shipping label which is sent along with the replacement item. The customer is responsible for properly packaging and shipping the faulty item back to Bay Tek Games.

	ATTENTION	
<p>In order to maintain the safety & compliance certifications of this game, ONLY approved parts may be used. For approved replacement parts, refer to the parts list in this manual.</p>		

Should you need your game serviced, determine the serial number from the decal placed on the front of this manual, or locate it on the back of the game. Then contact our Service Department at: 920.822.3951 or e-mail: service@baytekgames.com

NON-WARRANTY

Options and estimated charges will be provided to you for your approval.

Please remember that any items being sent to Bay Tek Games must include prior return authorization from our Parts & Service Department.

This approval will include a Product Return Form which is required to be included with any incoming shipments. Repaired parts will be shipped back using the same method in which they were received.

Repairs are warranted for 30 days from the date of return shipment.

CERTIFICATE OF COMPLIANCE